

konusulan
the spoken kalite...
quality...

2018

Kesici Uç Bağlama Sistemleri
Connection Systems For Cutting Inserts.

www.akko.com.tr



 **AKKO**[®]

Дистрибьютер ООО "Ресурс Плюс"
+7 (351) 247-74-40; info@rp-ural.ru



konusulan
the spoken kalite...
quality...





1986 yılında Abdullah KARAKUŞ tarafından kurulan AKKO Oto. Mak. Hırd. San. Tic. Ltd. Şti. Tornalama Takımları, Diş ve Kanal Açma Takımları, Delik Delme Takımları, Frezeleme Takımları ve Özel Takımları üretmektedir. Şu an 8000 m² ye yakın bir alanda Türkiye, Japonya, Almanya, İsviçre gibi ülkelerin ürettikleri son teknoloji tezgah ve ekipmanlarıyla yıllık 300.000 adet üretim kapasitesiyle, standart 6000 çeşit takım üretimi yapmaktadır. Avrupa, Asya, Afrika, Güney Amerika ve Orta Doğu'da şimdilik 61 ülkeye ürün sevkiyatına devam etmekte olup 200.000 adet civarında üretilmiş ürün stoklarında mevcuttur. Firmaya, özel üretilen çelik hammadde işleme girer ve bütün üretim süreci bünyesinde gerçekleşir. Çeliğin işlenmesi, ısıl işleme, üzerindeki kaplama ve her türlü üretim süreci bir entegre tesis olan AKKO'da gerçekleşir.



We as AKKO Oto. Mak. Hird. San. Tic. Ltd. Şti, which has been founded by Abdullah KARAKUŞ in 1986, produce Turning Tool Holders, Threading and Grooving Tool Holders, U-Drills, Milling Tool Holders and Precision Tool Holders (OEM Tool Holders). We produce standard 6000 kinds of tool holders with production capacity of 300.000 pieces per annum in an area about 8000 square meter. We are going on exporting 61 countries including European, Asian, African, Asian, South American Countries and Middle East Countries. We keep ready about 200.000 pieces produced products in our stock. Steel Raw materials that we make produced especially for us are delivered our factory and all production process are made in our factory. All kind of process from machining of steel to heat treatment and coating on our tools are made in our integrated factory AKKO.

DIŞ TORNA TAKIMLARI	
S9	DIŞ TORNA KATERLERİ KODLAMA SİSTEMİ
S10-S19	T-SİSTEM DIŞ TORNA KATERLERİ
S20-S22	M-SİSTEM DIŞ TORNA KATERLERİ
S23-S31	P-SİSTEM DIŞ TORNA KATERLERİ
S32-S37	C-SİSTEM DIŞ TORNA KATERLERİ
S38-S51	S-SİSTEM DIŞ TORNA KATERLERİ
S51-S56	S-SİSTEM İSVİÇRE TİPİ KAYAR OTOMAT MAKİNA TAKIMLARI

DELİK TORNA TAKIMLARI	
S58	DELİK TORNA KATERLERİ KODLAMA SİSTEMİ
S59-S64	T&C SİSTEM DELİK TORNA KATERLERİ
S65-S69	M-SİSTEM DELİK TORNA KATERLERİ
S70-S75	P-SİSTEM DELİK TORNA KATERLERİ
S76-S91	S-SİSTEM DELİK TORNA KATERLERİ

KARTUŞLAR	
S93	KARTUŞLARIN KODLAMA SİSTEMİ
S94-S95	S-TİP REKTEFİYE KARTUŞLARI
S96-S98	S-SİSTEM KARTUŞLAR
S99-S101	P-SİSTEM KARTUŞLAR VE BORU PAHLAMA TAKIMLARI

DIŞ AÇMA TAKIMLARI	
S103	DIŞ AÇMA KATERLERİ KODLAMA SİSTEMİ
S104-S109	DIŞ AÇMA KATERLERİ ve TEKNİK BİLGİ

KANAL AÇMA TAKIMLARI	
S111	KANAL KATERLERİ KODLAMA SİSTEMİ
S112-S124	DIŞ ÇAP KANAL AÇMA TAKIMLARI
S124-S126	DIŞ ÇAP KANAL AÇMA İSVEÇ TİPİ KAYAR OTOMAT MAKİNA TAKIMLARI
S126-S129	DIŞ ÇAP ALIN KANAL AÇMA TAKIMLARI
S130	L TİP ALIN KANAL AÇMA TAKIMLARI
S130-S131	KESME VE DERİN KANAL AÇMA LAMALARI
S131	KESME VE DERİN KANAL AÇMA LAMA BLOĞU
S132-S140	DELİK İÇİ KANAL KATERLERİ

DELİK DELME ve İŞLEME TAKIMLARI	
S143-S165	TAKMA UÇLU MATKAPLAR ve KODLAMA SİSTEMİ
S166-S167	DELİK PAHLAMA TAKIMI VE MONTAJ ŞEKLİ
S168	EKSANTRİK TAKMA UÇLU MATKAP ADAPTÖRÜ
S169	ÖZEL DELİK DELME ve İŞLEME TAKIMI SİPARİŞ FORMU
S171-S172	EKONOMİK KEŞİCİLER ve KODLAMA SİSTEMİ
S174-S178	AYARLI DELİK İŞLEME BARALARI ve KODLAMA SİSTEMİ

FREZELEME TAKIMLARI	
S180	FREZELEME TAKIMLARI KODLAMA SİSTEMİ
S181-S182	S-SİSTEM PAH FREZELER
S182	HELİS PAH FREZELEME TAKIMLARI
S183	SİLİNDİRİK ALYAN BAŞLI VİDA (DIN 974-1) HAVŞALARINI AÇMA FREZELERİ
S184-S203	S-SİSTEM YÜZEY PARMAK FREZELER
S204-S206	S-SİSTEM YÜZEY ve KOPYA PARMAK FREZELER
S206-S210	S-SİSTEM HIZLI İLERLEMELİ PARMAK FREZELER
S210-S217	S-SİSTEM MODÜLER PARMAK FREZELER
S218-S221	S-SİSTEM HIZLI İLERLEMELİ MODÜLER PARMAK FREZELER
S221-S222	KÜRE UÇLU PARMAK FREZELER
S223-S224	MODÜLER KÜRE UÇLU PARMAK FREZELER
S224	VİDALI TAKIM TUTUCULARI
S225-S226	DIŞ AÇMA FREZELEME TAKIMLARI
S227	S-SİSTEM HELİS FREZELER
S228-S252	YÜZEY FREZELER
S253-S256	YÜZEY ve KOPYA FREZELER
S257-S259	C-SİSTEM YÜZEY FREZELER
S260-S264	HIZLI İLERLEMELİ FREZELER
S265-S266	T KANAL FREZELER
S267-S268	DİSK FREZELER
S269-S273	FREZELEME TAKIMLARI MONTAJ ÖLÇÜLERİ ve TEKNİK BİLGİLER

YEDEK PARÇALAR	
S274-S287	YEDEK PARÇALAR
S288-S289	ÜRÜN GRUPLARINA GÖRE İÇİNDEKİLER

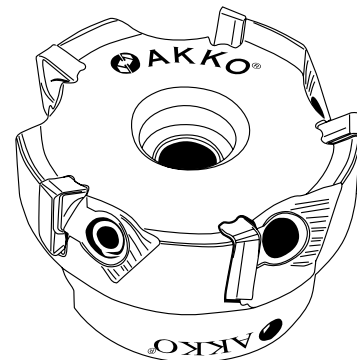
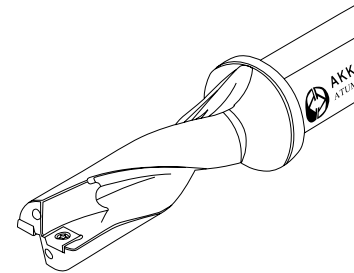
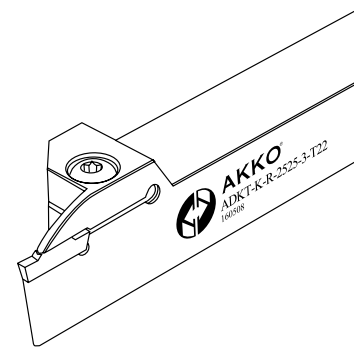
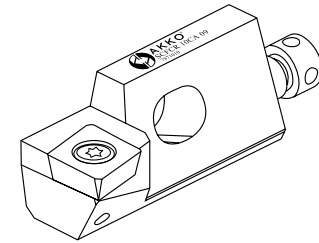
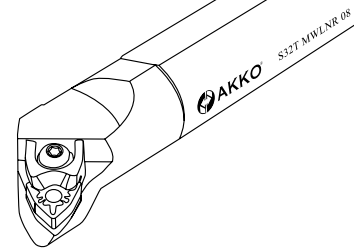
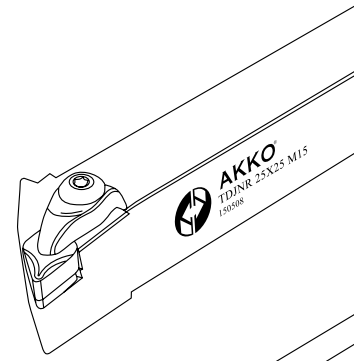

İÇİNDEKİLER

CONTENTS

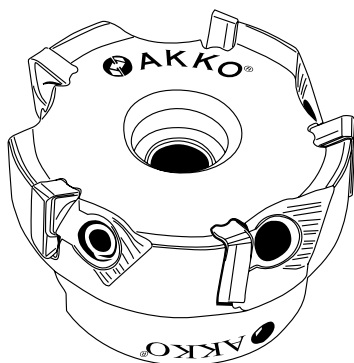
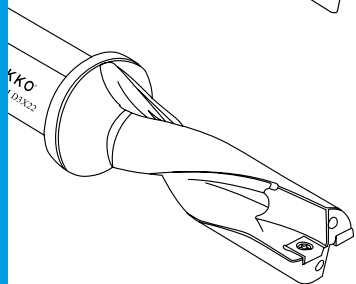
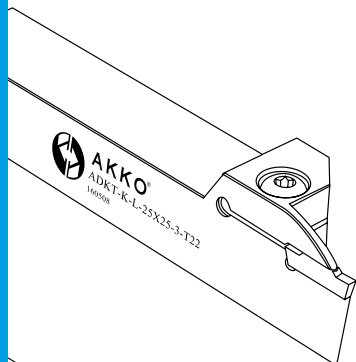
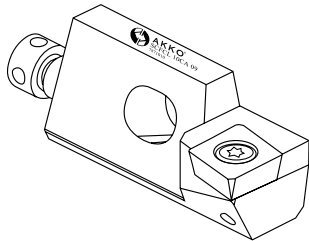
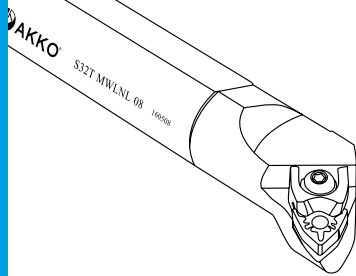
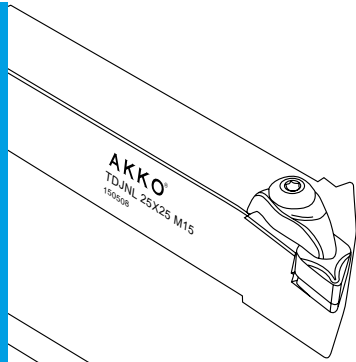

	EXTERNAL TURNING TOOLHOLDERS
P9	EXTERNAL TURNING TOOLHOLDERS DESIGNATION SYSTEM
P10-P19	T-SYSTEM EXTERNAL TURNING TOOLHOLDERS
P20-P22	M-SYSTEM EXTERNAL TURNING TOOLHOLDERS
P23-P31	P-SYSTEM EXTERNAL TURNING TOOLHOLDERS
P32-P37	C-SYSTEM EXTERNAL TURNING TOOLHOLDERS
P38-P51	S-SYSTEM EXTERNAL TURNING TOOLHOLDERS
P51-P56	S-SYSTEM TOOLS FOR SWISS TYPE SLIDING AUTOMATIC LATHES

	INTERNAL TURNING TOOLHOLDERS
P58	BORING BARS DESIGNATION SYSTEM
P59-P64	T&C SYSTEM BORING BARS
P65-P69	M-SYSTEM BORING BARS
P70-P75	P-SYSTEM BORING BARS
P76-P91	S-SYSTEM BORING BARS

	CARTRIDGE
P93	CARTRIDGE DESIGNATION SYSTEM
P94-P95	S-TYPE ENGINE OVERHAUL CARTRIDGE
P96-P98	S-SYSTEM CARTRIDGE
P99-P101	P-SYSTEM CARTRIDGE AND PIPE BEVELING and CHAMFERING TOOLS

	THREADING TOOLHOLDERS
P103	THREADING TOOLHOLDERS DESIGNATION SYSTEM
P104-P109	THREADING TOOLHOLDERS and TECHNICAL INFORMATION

	GROOVING TOOLHOLDERS
P111	GROOVING TOOLHOLDERS DESIGNATION SYSTEM
P112-P124	EXTERNAL GROOVING TOOLHOLDERS
P124-P126	EXTERNAL GROOVING TOOLHOLDERS FOR SWISS TYPE SLIDING AUTOMATIC LATHES
P126-P129	FACE EXTERNAL GROOVING TOOLHOLDERS
P130	L TYPE FACE EXTERNAL GROOVING TOOLHOLDERS
P130-P131	BLADES FOR PARTING AND DEEP GROOVING
P131	BLOCKS FOR PARTING AND DEEP GROOVING BLADES
P132-P140	INTERNAL GROOVING TOOLHOLDERS

	DRILLING and HOLEMAKING TOOLS
P143-P165	U-DRILL SYSTEM and DESIGNATION SYSTEM
P166-P167	DRILL CHAMFERING RING TOOLS AND MOUNTING SYSTEM
P168	EXCENTRIC ADAPTOR FOR U-DRILLS
P169	SPECIAL DRILL ORDER FORM
P171-P172	ECONOMIC CUTTING TOOLS and DESIGNATION SYSTEM
P174-P178	ADJUSTABLE BORING HEADS and DESIGNATION SYSTEM

	MILLING TOOLS
P180	MILLING TOOLS DESIGNATION SYSTEM
P181-P182	S-SYSTEM CHAMFERING END MILLS
P182	HELIX CHAMFER MILLING TOOLS
P183	COUNTERSINK MILLING TOOL FOR CYLINDRICAL ALLEN HEAD SCREWS (DIN 974-1)
P184-P203	S-SYSTEM END MILLS
P204-P206	S-SYSTEM FACE and COPY END MILLS
P206-P210	S-SYSTEM HIGHFEED END MILLS
P210-P217	S-SYSTEM MODULAR END MILLS (SCREW TYPE TOOLS)
P218-P221	S-SYSTEM MODULAR (SCREW TYPE) HIGHFEED END MILLS
P221-P222	BALL NOSE MILLS
P223-P224	BALL NOSE MODULAR (SCREW TYPE) END MILLS
P224	SCREWED TOOL HOLDERS
P225-P226	THREAD MILLING TOOLS
P227	S-SYSTEM HELIX END MILL
P228-P252	FACE MILLING
P253-P256	FACE and COPY MILLING TOOLS
P257-P259	C-SYSTEM FACE MILLING
P260-P264	HIGH FEED MILLING TOOLS
P265-P266	T SLOT MILLING
P267-P268	DISC MILLING
P269-P271	MOUNTING REFERENCE FOR MILLING CUTTERS and TECHNICAL INFORMATION

	SPARE PARTS
P272-P285	SPARE PARTS
P288-P289	INDEX

DIŞ TORNA TAKIMLARI
EXTERNAL TURNING TOOLHOLDERS





P **S** **K** **N** **R**

1 2 3 4 5

1 Sıkma Tipi / Method of Mounting of Insert

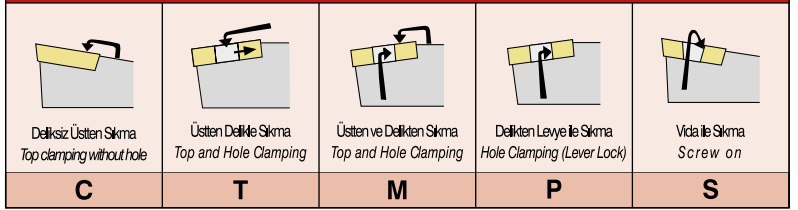

2 Uç Tipi / Insert Shape

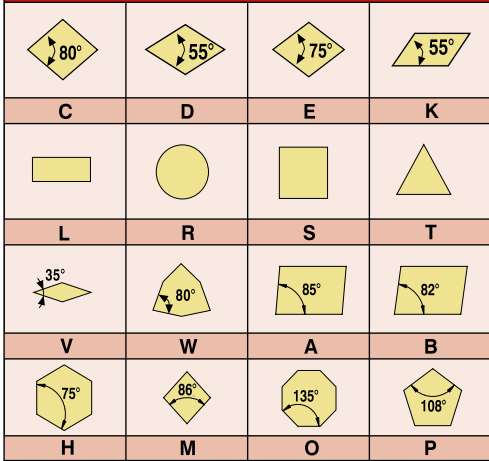

3 Yanaşma Açısı / ToolHolder Shape

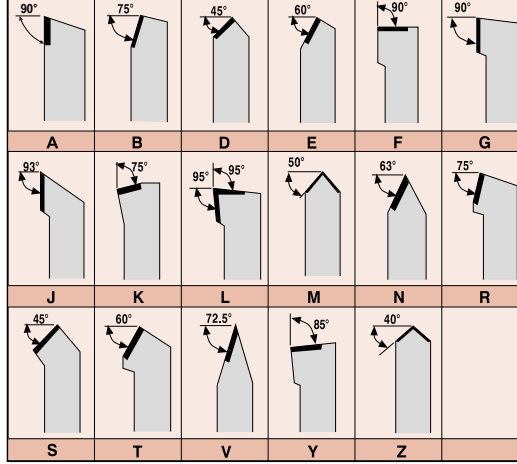

4 Serbest Uç Açısı / Clearance angle of Insert

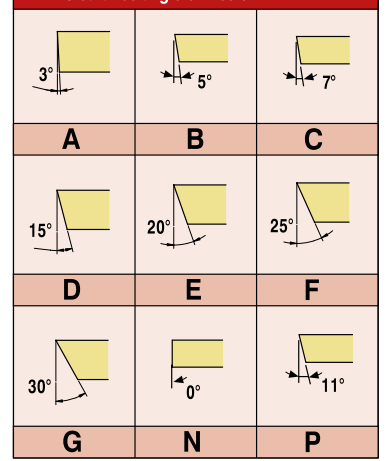

25 **25** - **M** **12** **C**

6 7 8 9 10

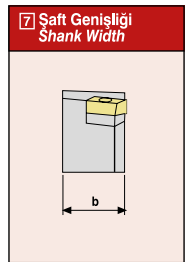
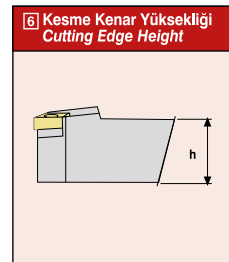
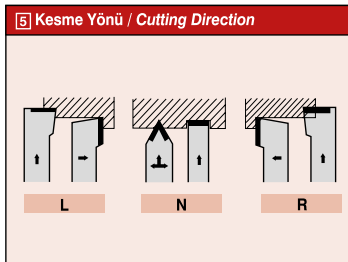

8 Şaft Boyu / Shank Length

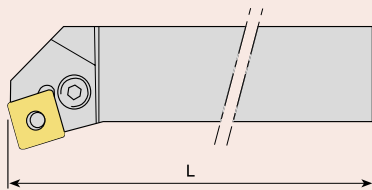

A - 32	H - 100	Q - 180	x-special
B - 40	J - 110	R - 200	
C - 50	K - 125	S - 250	
D - 60	L - 140	T - 300	
E - 70	M - 150	U - 350	
F - 80	N - 160	V - 400	
G - 90	P - 170	W - 450	

9 Kesme Kenar Uzunluğu / Cutting Edge Length

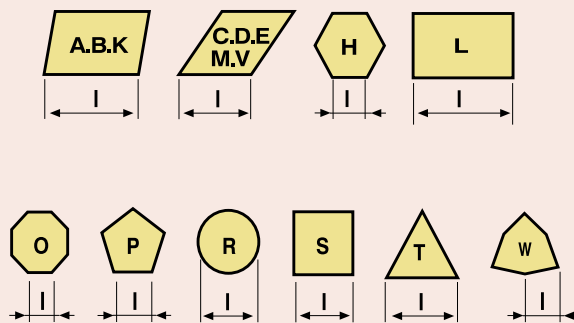

10 Baskı Pabucu / Wedge Clamp

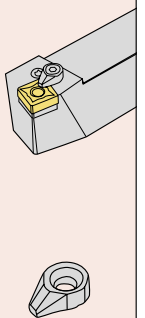



*konusulan
the spoken kalite...
quality...*

T-SİSTEM

T-SİSTEM DIŞ TORNA KATERLERİ

T-SYSTEM EXTERNAL TURNING TOOLHOLDERS



www.akkо.com.tr

Дистрибьютер ООО "Ресурс Плюс"
+7 (351) 247-74-40; info@rp-ural.ru

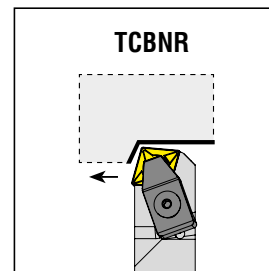
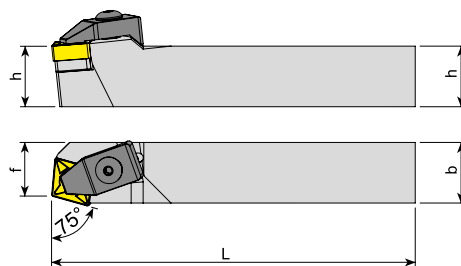

Takım Kodu Ordering Code	Stok Stock		Takım Ölçüleri (mm) Dimension (mm)				Kesici Uç Insert	Yedek Parçaları Spare Parts						
	R	L	h	b	L	f		Baskı Pabucu Wedge Clamp	Pabuç Vidası Clamp Screw	Altık Shim	Altık Vidası Shim Screw	Yay Spring	Pul Stamp	Anahtar Allen Key
TCBNR/L 2525 M16	●	●	25	25	150	22	CNM. 1606..	ATK-04	AKV-19-M7x25	AACN-3-0002	AAV-05-M6x15	-	ABPL-02	AAL-05-4

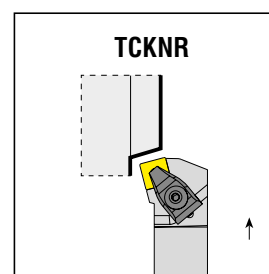
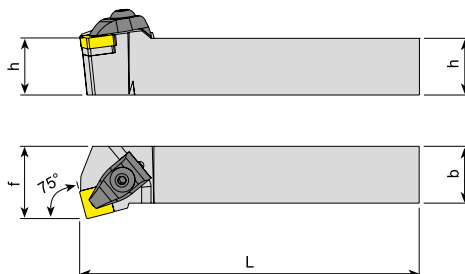

Takım Kodu Ordering Code	Stok Stock		Takım Ölçüleri (mm) Dimension (mm)				Kesici Uç Insert	Yedek Parçaları Spare Parts						
	R	L	h	b	L	f		Baskı Pabucu Wedge Clamp	Pabuç Vidası Clamp Screw	Altık Shim	Altık Vidası Shim Screw	Yay Spring	Pul Stamp	Anahtar Allen Key
TCKNR/L 2020 K12	●	●	20	20	125	25	CNM. 1204..	ATK-02	AKV-02-M6x22	AACN-3-0001	AAV-02-M5x12	AKY-01	ABPL-01	AAL-03-3
2525 M12	●	●	25	25	150	32								
3232 P12	●	●	32	32	170	40								
2525 M16	●	●	25	25	150	32	CNM. 1606..	ATK-04	AKV-19-M7x25	AACN-3-0002	AAV-05-M6x15	-	ABPL-02	AAL-05-4
3232 P16	●	●	32	32	170	40								

R: Sağ/Right L: Sol/Left ● Stokta/In Stock ○ Stokta Yok/Non Stock Item

Sipariş Örneği/Ordering Example : 1 ad./pcs. TCBNR 2525 M16

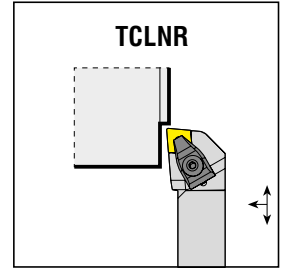
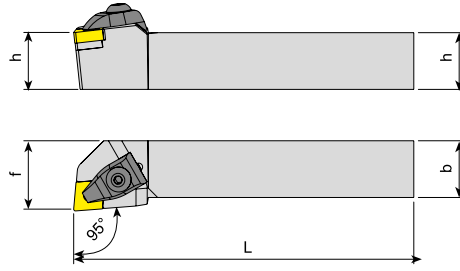

Takım Kodu Ordering Code	Stok Stock		Takım Ölçüleri (mm) Dimension (mm)				Kesici Uç Insert	Yedek Parçaları Spare Parts						
	R	L	h	b	L	f		Baskı Pabucu Wedge Clamp	Pabuç Vidası Clamp Screw	Altlık Shim	Altlık Vidası Shim Screw	Yay Spring	Pul Stamp	Anahtar Allen Key
TCLNR/L 2020 K12	●	●	20	20	125	25	CNM. 1204..							
2525 M12	●	●	25	25	150	32								
3232 P12	●	●	32	32	170	40								
4040 S12	●	●	40	40	250	50								
5050 S12	●	●	50	50	250	63	CNM. 1606..							
2525 M16	●	●	25	25	150	32								
3232 P16	●	●	32	32	170	40								

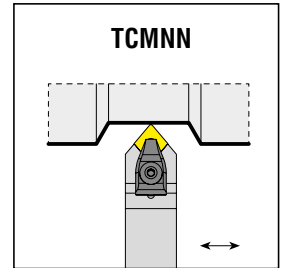
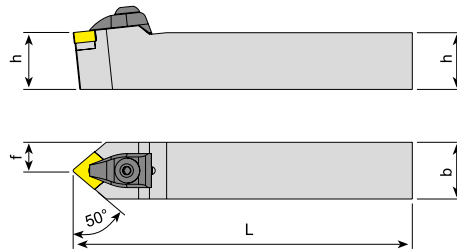

Takım Kodu Ordering Code	Stok Stock		Takım Ölçüleri (mm) Dimension (mm)				Kesici Uç Insert	Yedek Parçaları Spare Parts						
			h	b	L	f		Baskı Pabucu Wedge Clamp	Pabuç Vidası Clamp Screw	Altlık Shim	Altlık Vidası Shim Screw	Yay Spring	Pul Stamp	Anahtar Allen Key
TCMNN 1616 H12	●		16	16	100	8	CNM. 1204..							
2020 K12	●		20	20	125	10								
2525 M12	●		25	25	150	12.5								
3232 P12	●		32	32	170	16								
2525 M16	●		25	25	150	12.5	CNM. 1606..							
3232 P16	●		32	32	170	16								
4040 S16	○		40	40	250	20								

R: Sağ/Right L: Sol/Left ● Stokta/In Stock ○ Stokta Yok/Non Stock Item

Sipariş Örneği/Ordering Example : 1 ad./pcs. TCLNR 2020 K12

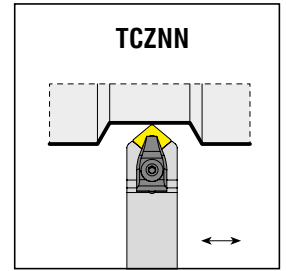
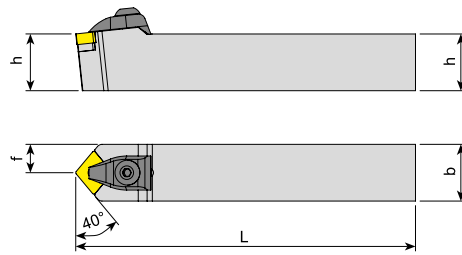

Takım Kodu Ordering Code	Stok Stock		Takım Ölçüleri (mm) Dimension (mm)				Kesici Uç Insert	Yedek Parçaları Spare Parts						
	R	L	h	b	L	f		Baskı Pabucu Wedge Clamp	Pabuç Vidası Clamp Screw	Altılık Shim	Altılık Vidası Shim Screw	Yay Spring	Pul Stamp	Anahtar Allen Key
TCZNN 2020 K12	●		20	20	125	10								
2525 M12	●		25	25	150	12.5								
3232 P12	●		32	32	170	16								
2525 M16	●		25	25	150	12.5								
3232 P16	●		32	32	170	16								

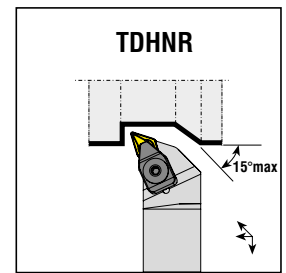
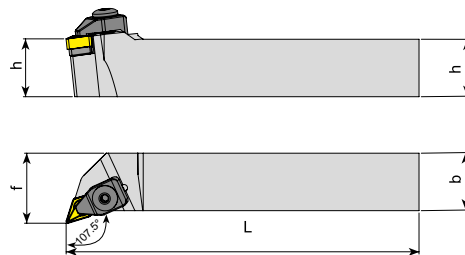

Takım Kodu Ordering Code	Stok Stock		Takım Ölçüleri (mm) Dimension (mm)				Kesici Uç Insert	Yedek Parçaları Spare Parts						
	R	L	h	b	L	f		Baskı Pabucu Wedge Clamp	Pabuç Vidası Clamp Screw	Altılık Shim	Altılık Vidası Shim Screw	Yay Spring	Pul Stamp	Anahtar Allen Key
TDHNR/L 2020 K15	●	●	20	20	125	25								
2525 M15	●	●	25	25	150	32								
3232 P15	●	●	32	32	170	40								

R: Sağ/Right L: Sol/Left ● Stokta/In Stock ○ Stokta Yok/Non Stock Item

Sipariş Örneği/Ordering Example : 1 ad./pcs. TCZNN 2020 K12

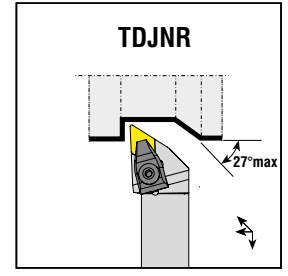
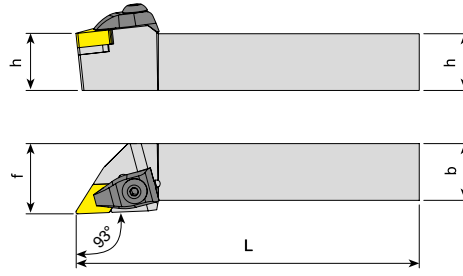

Takım Kodu Ordering Code	Stok Stock		Takım Ölçüleri (mm) Dimension (mm)				Kesici Uç Insert	Yedek Parçaları Spare Parts						
	R	L	h	b	L	f		Baskı Pabucu Wedge Clamp	Pabuç Vidası Clamp Screw	Altılık Shim	Altılık Vidası Shim Screw	Yay Spring	Pul Stamp	Anahtar Allen Key
TDJNR/L 1616 H11	●	●	16	16	100	20	DNM. 1104..							
2020 K11	●	●	20	20	125	25								
2525 M11	●	●	25	25	150	32								
2020 K15	●	●	20	20	125	25	DNM. 1506..							
2525 M15	●	●	25	25	150	32								
3232 P15	●	●	32	32	170	40								
4040 S15	●	●	40	40	250	50								
5050 S15	○	○	50	50	250	63	DNM. 1504..							
2020 K1504	●	●	20	20	125	25								
2525 M1504	●	●	25	25	150	32								
3232 P1504	●	●	32	32	170	40								
4040 S1504	●	●	40	40	250	50								

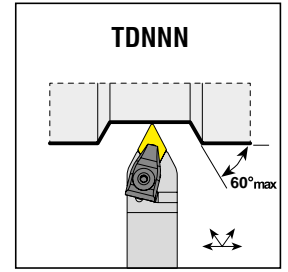
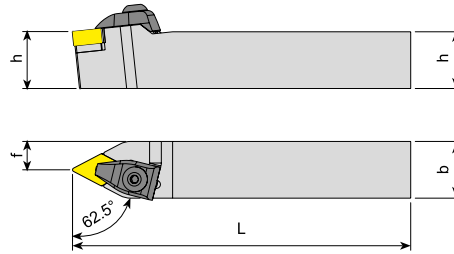

Takım Kodu Ordering Code	Stok Stock		Takım Ölçüleri (mm) Dimension (mm)				Kesici Uç Insert	Yedek Parçaları Spare Parts						
	R	L	h	b	L	f		Baskı Pabucu Wedge Clamp	Pabuç Vidası Clamp Screw	Altılık Shim	Altılık Vidası Shim Screw	Yay Spring	Pul Stamp	Anahtar Allen Key
TDNNN 1616 H11	●	●	16	16	100	8	DNM. 1104..							
2020 K11	●	●	20	20	125	10								
2525 M11	●	●	25	25	150	12.5								
2020 K15	●	●	20	20	125	10	DNM. 1506..							
2525 M15	●	●	25	25	150	12.5								
3232 P15	●	●	32	32	170	16								
4040 S15	○	○	40	40	250	20								
5050 S15	○	○	50	50	250	25								

R: Sağ/Right L: Sol/Left ● Stokta/In Stock ○ Stokta Yok/Non Stock Item

Sipariş Örneği/Ordering Example : 1 ad./pcs. TDJNR 1616 H11

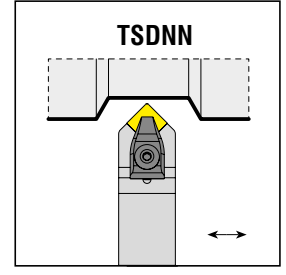
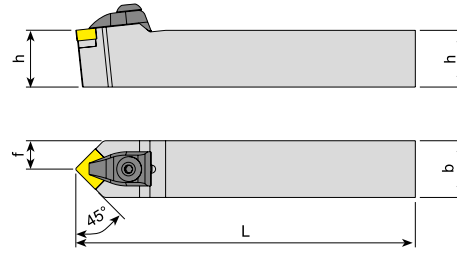

Takım Kodu Ordering Code	Stok Stock	Takım Ölçüleri (mm) Dimension (mm)				Kesici Uç Insert	Yedek Parçaları Spare Parts						
		h	b	L	f		Baskı Pabucu Wedge Clamp	Pabuç Vidası Clamp Screw	Altılık Shim	Altılık Vidası Shim Screw	Yay Spring	Pul Stamp	Anahtar Allen Key
TSDNN 1616 H12	●	16	16	100	8	SNM. 1204..							
2020 K12	●	20	20	125	10								
2525 M12	●	25	25	150	12.5								
3232 P12	●	32	32	170	16								
2525 M15	○	25	25	150	12.5	SNM. 1506..							
3232 P15	○	32	32	170	16								
4040 S15	○	40	40	250	20								

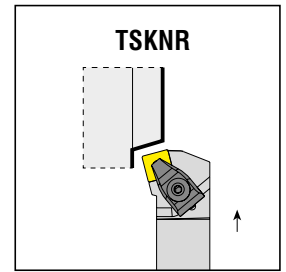
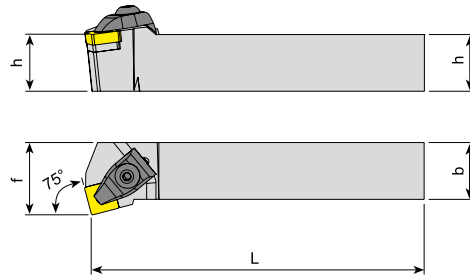

Takım Kodu Ordering Code	Stok Stock		Takım Ölçüleri (mm) Dimension (mm)				Kesici Uç Insert	Yedek Parçaları Spare Parts						
	R	L	h	b	L	f		Baskı Pabucu Wedge Clamp	Pabuç Vidası Clamp Screw	Altılık Shim	Altılık Vidası Shim Screw	Yay Spring	Pul Stamp	Anahtar Allen Key
TSKNR/L 2020 K12	●	●	20	20	125	25	SNM. 1204..							
2525 M12	●	●	25	25	150	32								
3232 P12	●	●	32	32	170	40								
3232 P15	●	●	32	32	170	40								
							SNM. 1506..							

R: Sağ/Right L: Sol/Left ● Stokta/In Stock ○ Stokta Yok/Non Stock Item

Sipariş Örneği/Ordering Example : 1 ad./pcs. TSDNN 1616 H12

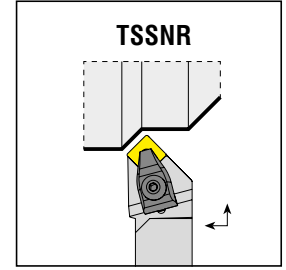
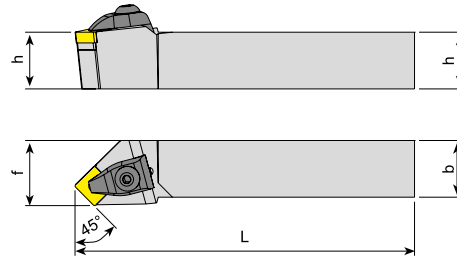

Takım Kodu Ordering Code	Stok Stock		Takım Ölçüleri (mm) Dimension (mm)				Kesici Uç Insert	Yedek Parçaları Spare Parts							
	R	L	h	b	L	f		Baskı Pabucu Wedge Clamp	Pabuç Vidası Clamp Screw	Altlık Shim	Altlık Vidası Shim Screw	Yay Spring	Pul Stamp	Anahtar Allen Key	
TSSNR/L 2020 K12	●	●	20	20	125	25									
2525 M12	●	●	25	25	150	32									SNM. 1204..
3232 P12	●	●	32	32	170	40									
2525 M15	●	●	25	25	150	32	SNM. 1506..					-			
3232 P15	●	●	32	32	170	40									

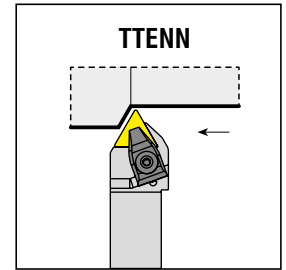
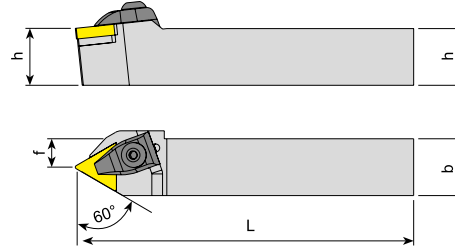

Takım Kodu Ordering Code	Stok Stock		Takım Ölçüleri (mm) Dimension (mm)				Kesici Uç Insert	Yedek Parçaları Spare Parts							
			h	b	L	f		Baskı Pabucu Wedge Clamp	Pabuç Vidası Clamp Screw	Altlık Shim	Altlık Vidası Shim Screw	Yay Spring	Pul Stamp	Anahtar Allen Key	
TTENN 2020 K16	●		20	20	125	10						-			
2525 M16	●		25	25	150	12.5									TNM. 1604..
3232 P16	●		32	32	170	16									
2525 M22	●		25	25	150	12.5	TNM. 2204..					AKY-01			
3232 P22	●		32	32	170	16									
4040 S22	○		40	40	250	20									

R: Sağ/Right L: Sol/Left ● Stokta/In Stock ○ Stokta Yok/Non Stock Item

Sipariş Örneği/Ordering Example : 1 ad./pcs. TSSNR 2020 K12

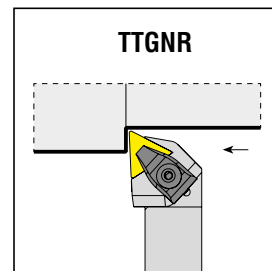
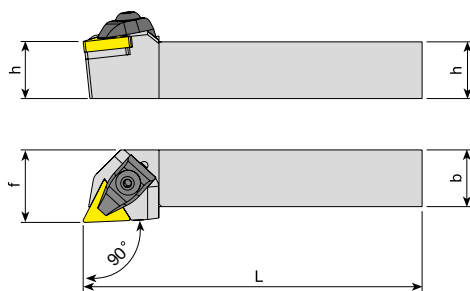

Takım Kodu Ordering Code	Stok Stock		Takım Ölçüleri (mm) Dimension (mm)				Kesici Uç Insert	Yedek Parçaları Spare Parts						
	R	L	h	b	L	f		Baskı Pabucu Wedge Clamp	Pabuç Vidası Clamp Screw	Aitlik Shim	Aitlik Vidası Shim Screw	Yay Spring	Pul Stamp	Anahtar Allen Key
TTGNR/L 2020 K16	●	●	20	20	125	25						-		
2525 M16	●	●	25	25	150	32								
3232 P16	●	●	32	32	170	40								
2525 M22	●	●	25	25	150	32								
3232 P22	●	●	32	32	170	40								
4040 S22	○	○	40	40	250	50								

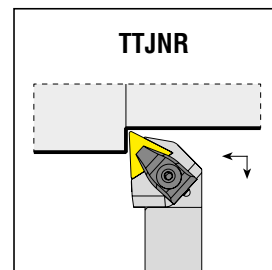
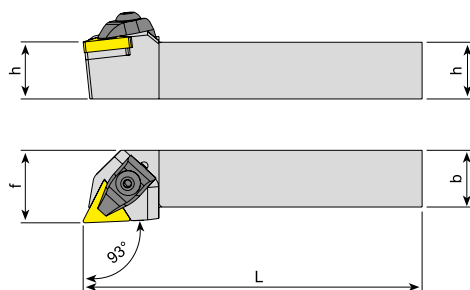

Takım Kodu Ordering Code	Stok Stock		Takım Ölçüleri (mm) Dimension (mm)				Kesici Uç Insert	Yedek Parçaları Spare Parts						
	R	L	h	b	L	f		Baskı Pabucu Wedge Clamp	Pabuç Vidası Clamp Screw	Aitlik Shim	Aitlik Vidası Shim Screw	Yay Spring	Pul Stamp	Anahtar Allen Key
TTJNR/L 2020 K16	●	●	20	20	125	25						-		
2525 M16	●	●	25	25	150	32								
3232 P16	●	●	32	32	170	40								
2525 M22	●	●	25	25	150	32								
3232 P22	●	●	32	32	170	40								
4040 S22	○	○	40	40	250	50								

R: Sağ/Right L: Sol/Left ●Stokta/In Stock ○Stokta Yok/Non Stock Item

Sipariş Örneği/Ordering Example : 1 ad./pcs. TTGNR 2020 K16

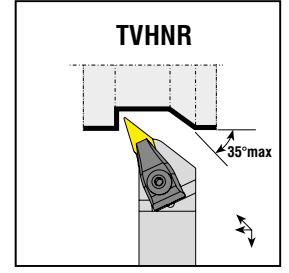
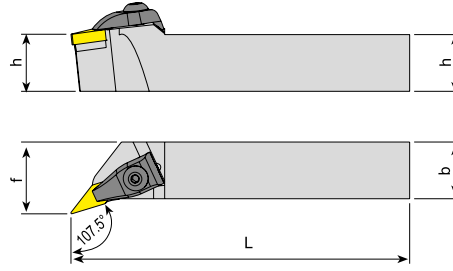

Takım Kodu Ordering Code	Stok Stock		Takım Ölçüleri (mm) Dimension (mm)				Kesici Uç Insert	Yedek Parçaları Spare Parts						
	R	L	h	b	L	f		Baskı Pabucu Wedge Clamp	Pabuç Vidası Clamp Screw	Altık Shim	Altık Vidası Shim Screw	Yay Spring	Pul Stamp	Anahtar Allen Key
TVHNR/L 2020 K16	●	●	20	20	125	25	VNM. 1604..							
2525 M16	●	●	25	25	150	32								
3232 P16	●	●	32	32	170	40								

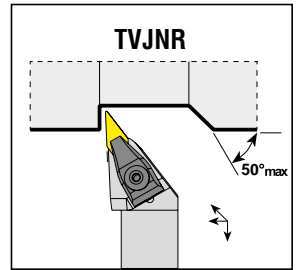
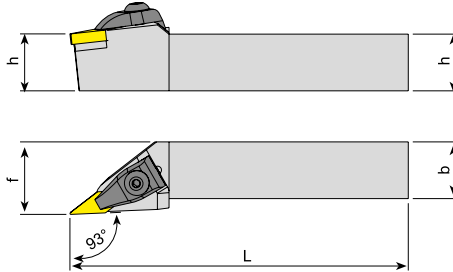

Takım Kodu Ordering Code	Stok Stock		Takım Ölçüleri (mm) Dimension (mm)				Kesici Uç Insert	Yedek Parçaları Spare Parts						
	R	L	h	b	L	f		Baskı Pabucu Wedge Clamp	Pabuç Vidası Clamp Screw	Altık Shim	Altık Vidası Shim Screw	Yay Spring	Pul Stamp	Anahtar Allen Key
TVJNR/L 2020 K16	●	●	20	20	125	25	VNM. 1604..							
2525 M16	●	●	25	25	150	32								
3232 P16	●	●	32	32	170	40								

R: Sağ/Right L: Sol/Left ● Stokta/In Stock ○ Stokta Yok/Non Stock Item

Sipariş Örneği/Ordering Example : 1 ad./pcs. TVHNR 2020 K16

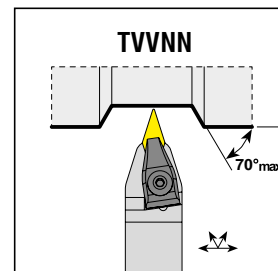
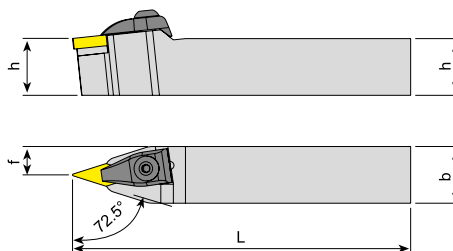

Takım Kodu Ordering Code	Stok Stock	Takım Ölçüleri (mm) Dimension (mm)				Kesici Uç Insert	Yedek Parçaları Spare Parts						
		h	b	L	f		Baskı Pabucu Wedge Clamp	Pabuç Vidası Clamp Screw	Altılık Shim	Altılık Vidası Shim Screw	Yay Spring	Pul Stamp	Anahtar Allen Key
TVVNN 2020 K16	●	20	20	125	10	VNM. 1604..	ATK-03	AKV-02-M6x22	AAVN-2-0002	AAV-04-M5x12	AKY-01	ABPL-01	AAL-03-3
2525 M16	●	25	25	150	12.5								
3232 P16	●	32	32	170	16								

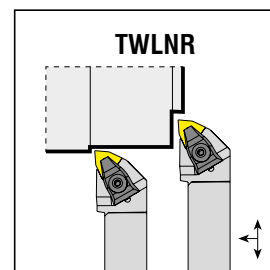
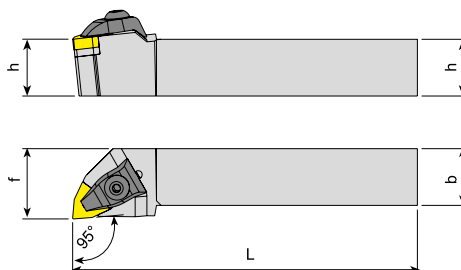

Takım Kodu Ordering Code	Stok Stock		Takım Ölçüleri (mm) Dimension (mm)				Kesici Uç Insert	Yedek Parçaları Spare Parts						
	R	L	h	b	L	f		Baskı Pabucu Wedge Clamp	Pabuç Vidası Clamp Screw	Altılık Shim	Altılık Vidası Shim Screw	Yay Spring	Pul Stamp	Anahtar Allen Key
TWLNR/L 1616 H06	●	●	16	16	100	20	WNM. 0604..	ATK-01	AKV-01-M5x22	AAWN-SW317	AAV-01-M3x10	-	ABPL-01	AAL-03-3
2020 K06	●	●	20	20	125	25								
2525 M06	●	●	25	25	150	32								
2020 K08	●	●	20	20	125	25	WNM. 0804..	ATK-02	AKV-02-M6x22	AAWN-3-0001	AAV-02-M5x12	AKY-01	ABPL-01	AAL-03-3
2525 M08	●	●	25	25	150	32								
3232 P08	●	●	32	32	170	40								
4040 S08	○	○	40	40	250	50								
5050 S08	○	○	50	50	250	63								

R: Sağ/Right L: Sol/Left ● Stokta/In Stock ○ Stokta Yok/Non Stock Item

Sipariş Örneği/Ordering Example : 1 ad./pcs. TVVNN 2020 K16



*konusulan
the spoken kalite...
quality...*

M-SİSTEM

M-SİSTEM DIŞ TORNA KATERLERİ

M-SYSTEM EXTERNAL TURNING TOOLHOLDERS



www.akkocom.tr

Дистрибьютер ООО "Ресурс Плюс"
+7 (351) 247-74-40; info@rp-ural.ru

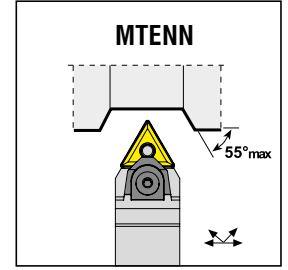
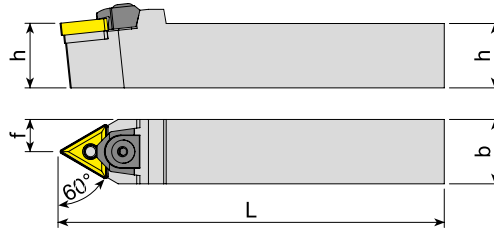

Takım Kodu Ordering Code	Stok Stock		Takım Ölçüleri (mm) Dimension (mm)				Kesici Uç Insert	Yedek Parçaları Spare Parts					
	R	L	h	b	L	f		Baskı Pabucu Wedge Clamp	Pabuç Vidası Clamp Screw	Altık Shim	Pim Pin	Pul Stamp	Anahtar Allen Key
MTENN 2020 K16	●		20	20	125	10	TNM. 1604..	AMK-04	AKV-02-M6x22	AATN-2-0002	APM-01	ABPL-01	AAL-03-3
2525 M16	●		25	25	150	12.5							
3232 P16	●		32	32	170	16	TNM. 2204..			AATN-3-0015	APM-02		
2525 M22	●		25	25	150	12.5							
3232 P22	●		32	32	170	16							
4040 S22	○		40	40	250	20							

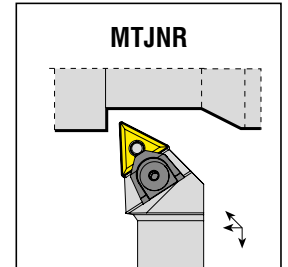
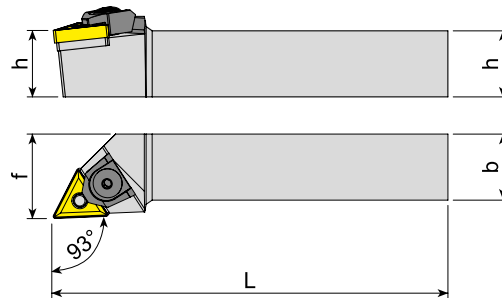

Takım Kodu Ordering Code	Stok Stock		Takım Ölçüleri (mm) Dimension (mm)				Kesici Uç Insert	Yedek Parçaları Spare Parts					
	R	L	h	b	L	f		Baskı Pabucu Wedge Clamp	Pabuç Vidası Clamp Screw	Altık Shim	Pim Pin	Pul Stamp	Anahtar Allen Key
MTJNR/L 2020 K16	●	●	20	20	125	25	TNM. 1604..	AMK-04	AKV-02-M6x22	AATN-2-0002	APM-01	ABPL-01	AAL-03-3
2525 M16	●	●	25	25	150	32							
3232 P16	●	●	32	32	170	40	TNM. 2204..			AATN-3-0015	APM-02		
2525 M22	●	●	25	25	150	32							
3232 P22	●	●	32	32	170	40							
4040 S22	●	●	40	40	250	50							

R: Sağ/Right L: Sol/Left ● Stokta/In Stock ○ Stokta Yok/Non Stock Item

Sipariş Örneği/Ordering Example : 1 ad./pcs. MTENN 2020 K16

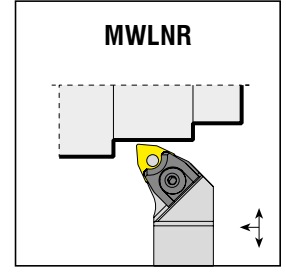
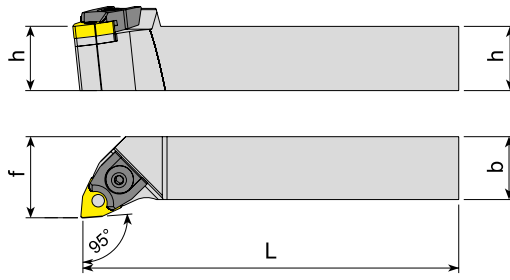

Takım Kodu Ordering Code	Stok Stock		Takım Ölçüleri (mm) Dimension (mm)				Kesici Uç Insert	Yedek Parçaları Spare Parts					
	R	L	h	b	L	f		Baskı Pabucu Wedge Clamp	Pabuç Vidası Clamp Screw	Altlık Shim	Pim Pin	Pul Stamp	Anahtar Allen Key
MWLNR/L 1616 H06	●	●	16	16	100	20				-		-	
2020 K06	●	●	20	20	125	25							
2525 M06	●	●	25	25	150	32							
2020 K08	●	●	20	20	125	25							
2525 M08	●	●	25	25	150	32							
3232 P08	●	●	32	32	170	40							

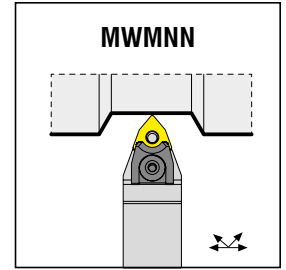
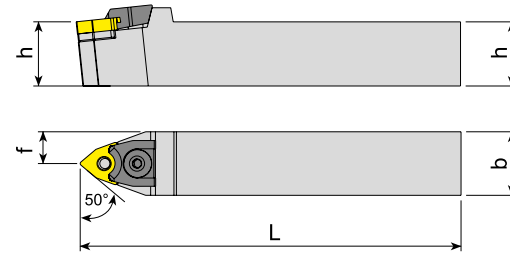

Takım Kodu Ordering Code	Stok Stock		Takım Ölçüleri (mm) Dimension (mm)				Kesici Uç Insert	Yedek Parçaları Spare Parts					
	R	L	h	b	L	f		Baskı Pabucu Wedge Clamp	Pabuç Vidası Clamp Screw	Altlık Shim	Pim Pin	Pul Stamp	Anahtar Allen Key
MWMNN 1616 H06	●	●	16	16	100	8				-		-	
2020 K06	●	●	20	20	125	10							
2525 M06	●	●	25	25	150	12.5							
2020 K08	●	●	20	20	125	10							
2525 M08	●	●	25	25	150	12.5							
3232 P08	●	●	32	32	170	16							

R: Sağ/Right L: Sol/Left ● Stokta/In Stock ○ Stokta Yok/Non Stock Item

Sipariş Örneği/Ordering Example : 1 ad./pcs. MWLNR 1616 H06

P-SİSTEM

P-SİSTEM DIŞ TORNA KATERLERİ

P-SYSTEM EXTERNAL TURNING TOOLHOLDERS

*konusulan
the spoken kalite...
quality...*



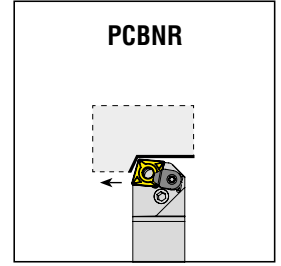
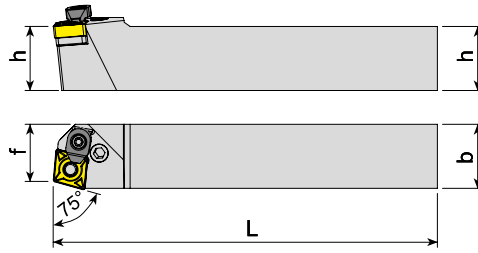

Takım Kodu Ordering Code	Stok Stock		Takım Ölçüleri (mm) Dimension (mm)				Kesici Uç Insert	Yedek Parçaları Spare Parts							
	R	L	h	b	L	f		Levyeye	Levyeye	Altılık	Altılık	Baskı	Baskı	Anahtar	
								Lever	Lever	Shim	Shim	Clamp	Clamp	Allen Key	
PCBNR/L 2020 K12C	●	●	20	20	125	17.5									
2525 M12C	●	●	25	25	150	22.5	CNM. 1204..	APL-02	ALV-03-M8x19	AACN-3-0001	AAY-02	ACK-05	1515-M4x11	AAL-03-3	
3232 P12C	●	●	32	32	170	29.5		CNM. 1606..	APL-04	ALV-04-M8x22	AACN-3-0002	AAY-03	ACK-09	AAV-05-M6x15	AAL-05-4
2525 M16C	●	●	25	25	150	22			APL-05	ALV-05-M10x27	AACN-3-0003	AAY-04			
3232 P16C	●	●	32	32	170	27	CNM. 1906..	APL-05	ALV-05-M10x27	AACN-3-0003	AAY-04	ACK-04	AKV-16-M6x16	AAL-07-5	
3232 P19C	●	●	32	32	170	27		APL-06	ALV-06-M12x36	AACN-3-0008	AAY-05				
4040 S19C	●	●	40	40	250	37	CNM. 2509..	APL-06	ALV-06-M12x36	AACN-3-0008	AAY-05	ACK-04	AKV-16-M6x16	AAL-07-5	
4040 S25C	●	●	40	40	250	37									
5050 S25C	○	○	50	50	250	47									

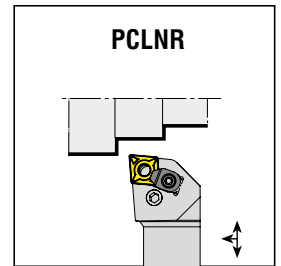
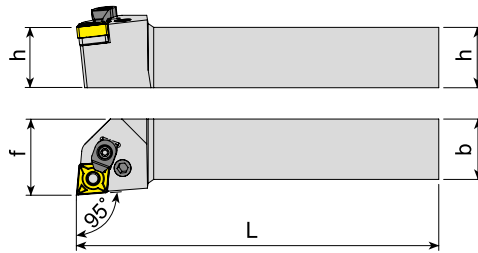

Takım Kodu Ordering Code	Stok Stock		Takım Ölçüleri (mm) Dimension (mm)				Kesici Uç Insert	Yedek Parçaları Spare Parts							
	R	L	h	b	L	f		Levyeye	Levyeye	Altılık	Altılık	Baskı	Baskı	Anahtar	
								Lever	Lever	Shim	Shim	Clamp	Clamp	Allen Key	
PCLNR/L 1616 H09	●	●	16	16	100	20	CNM. 0903..	APL-01	ALV-02-M6x17	AACN-2-0002	AAY-01	-	-	AAL-02-2.5	
2020 K09	●	●	20	20	125	25		CNM. 1204..	APL-02	ALV-03-M8x19	AACN-3-0001	AAY-02	ACK-05	1515-M4x11	AAL-03-3
2525 M09	●	●	25	25	150	32			APL-04	ALV-04-M8x22	AACN-3-0002	AAY-03	ACK-09	AAV-05-M6x15	AAL-05-4
1616 H12	●	●	16	16	100	20	CNM. 1906..	APL-05	ALV-05-M10x27	AACN-3-0003	AAY-04				
2020 K12C	●	●	20	20	125	25		CNM. 2509..	APL-06	ALV-06-M12x36	AACN-3-0008	AAY-05	ACK-04	AKV-16-M6x16	AAL-07-5
2525 M12C	●	●	25	25	150	32									
3232 P12C	●	●	32	32	170	40									
2525 M16C	●	●	25	25	150	32	CNM. 1606..	APL-04	ALV-04-M8x22	AACN-3-0002	AAY-03	ACK-09	AAV-05-M6x15	AAL-05-4	
3232 P16C	●	●	32	32	170	40									
2525 M19C	●	●	25	25	150	32	CNM. 1906..	APL-05	ALV-05-M10x27	AACN-3-0003	AAY-04	ACK-04	AKV-16-M6x16	AAL-07-5	
3232 P19C	●	●	32	32	170	40									
4040 S19C	●	●	40	40	250	50	CNM. 2509..	APL-06	ALV-06-M12x36	AACN-3-0008	AAY-05	ACK-04	AKV-16-M6x16	AAL-07-5	
4040 S25C	●	●	40	40	250	50									
5050 S25C	●	●	50	50	250	60									

R: Sağ/Right L: Sol/Left ● Stokta/In Stock ○ Stokta Yok/Non Stock Item

Sipariş Örneği/Ordering Example : 1 ad./pcs. PCBNR 2020 K12C

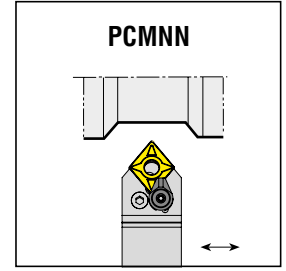
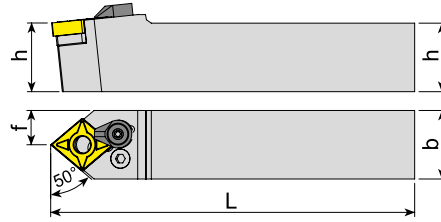

Takım Kodu Ordering Code	Stok Stock		Takım Ölçüleri (mm) Dimension (mm)				Kesici Uç Insert	Yedek Parçaları Spare Parts						
	R	L	h	b	L	f		Levyeye Lever	Levyeye Vidası Lever Screw	Altık Shim	Altık Yayı Shim Spring	Baskı Parçası Wedge Clamp	Baskı Vidası Clamp Screw	Anahtar Allen Key
PCMNN 2020 K12C	●		20	20	125	10	CNM. 1204..	APL-02	ALV-03-M8x19	AACN-3-0001	AAY-02	ACK-05	1515-M4x11	AAL-03-3
2525 M12C	●		25	25	150	12.5								
3232 P12C	○		32	32	170	16								
2525 M16C	○		25	25	150	12.5	CNM. 1606..	APL-04	ALV-04-M8x22	AACN-3-0002	AAY-03	ACK-09	AAV-05-M6x15	AAL-05-4
3232 P16C	○		32	32	170	16								
3232 P19C	●		32	32	170	16								
4040 S19C	○		40	40	250	20	CNM. 1906..	APL-05	ALV-05-M10x27	AACN-3-0003	AAY-04			
5050 S19C	○		50	50	250	25								
4040 S25C	●		40	40	250	20	CNM. 2509..	APL-06	ALV-06-M12x36	AACN-3-0008	AAY-05	ACK-04	AKV-16-M6x16	AAL-07-5

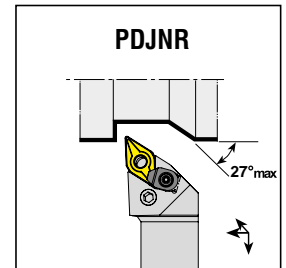
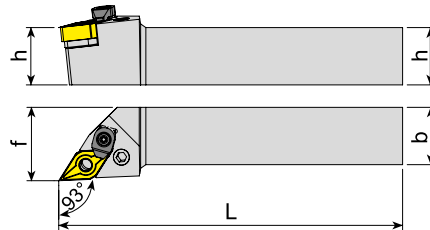

Takım Kodu Ordering Code	Stok Stock		Takım Ölçüleri (mm) Dimension (mm)				Kesici Uç Insert	Yedek Parçaları Spare Parts						
	R	L	h	b	L	f		Levyeye Lever	Levyeye Vidası Lever Screw	Altık Shim	Altık Yayı Shim Spring	Baskı Parçası Wedge Clamp	Baskı Vidası Clamp Screw	Anahtar Allen Key
PDJNR/L 1616 H11	●	●	16	16	100	20	DNM. 1104..	APL-01	ALV-02-M6x17	AADN-SD317	AAY-01	-	-	AAL-02-2.5
2020 K11	●	●	20	20	125	25								
2525 M11	●	●	25	25	150	32								
2020 K15C	●	●	20	20	125	25	DNM. 1506..	APL-03	ALV-03-M8x19	AADN-3-0001	AAY-02	ACK-05	1515-M4x11	AAL-03-3
2525 M15C	●	●	25	25	150	32								
3232 P15C	●	●	32	32	170	40								
4040 S15C	●	●	40	40	250	50								

R: Sağ/Right L: Sol/Left ● Stokta/In Stock ○ Stokta Yok/Non Stock Item

Sipariş Örneği/Ordering Example : 1 ad./pcs. PCMNN 2020 K12C

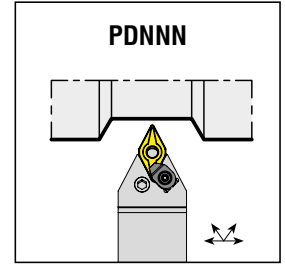
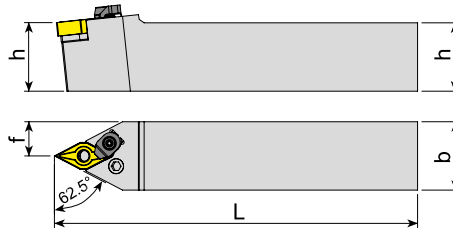

Takım Kodu Ordering Code	Stok Stock		Takım Ölçüleri (mm) Dimension (mm)				Kesici Uç Insert	Yedek Parçaları Spare Parts						
	R	L	h	b	L	f		Levye Lever	Levye Vidası Lever Screw	Altık Shim	Altık Yayı Shim Spring	Baskı Parçası Wedge Clamp	Baskı Vidası Clamp Screw	Anahtar Allen Key
PDN1616 H11	●		16	16	100	8	DNM. 1104..	APL-01	ALV-02-M6x17	AADN-SD317	AAY-01	-	-	AAL-02-2.5
2020 K11	●		20	20	125	10								
2525 M11	●		25	25	150	12.5								
2020 K15C	●		20	20	125	10	DNM. 1506..	APL-03	ALV-03-M8x19	AADN-3-0001	AAY-02	ACK-05	1515-M4x11	AAL-03-3
2525 M15C	●		25	25	150	12.5								
3232 P15C	●		32	32	170	16								

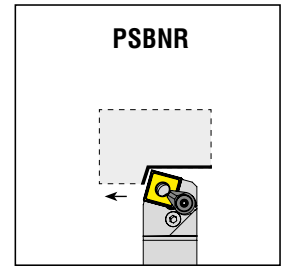
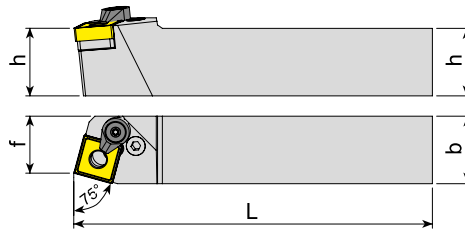
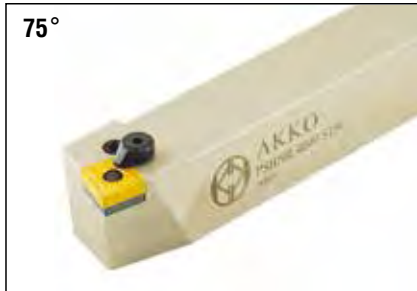

Takım Kodu Ordering Code	Stok Stock		Takım Ölçüleri (mm) Dimension (mm)				Kesici Uç Insert	Yedek Parçaları Spare Parts						
	R	L	h	b	L	f		Levye Lever	Levye Vidası Lever Screw	Altık Shim	Altık Yayı Shim Spring	Baskı Parçası Wedge Clamp	Baskı Vidası Clamp Screw	Anahtar Allen Key
PSB1616 H09	●	●	16	16	100	13	SNM. 0903..	APL-01	ALV-02-M6x17	AASN-2-0002	AAY-01	-	-	AAL-02-2.5
2020 K09	○	○	20	20	125	17								
2020 K12	●	●	20	20	125	17								
2525 M12C	●	●	25	25	150	22	SNM. 1204..	APL-02	ALV-03-M8x19	AASN-3-0004	AAY-02	ACK-05	1515-M4x11	AAL-03-3
3232 P12C	●	●	32	32	170	27								
2525 M15	○	●	25	25	150	22	SNM. 1506..	APL-04	ALV-04-M8x22	AASN-3-0023	AAY-03	-	-	-
3232 P15C	●	●	32	32	170	27								
3232 P19C	●	●	32	32	170	27	SNM. 1906..	APL-05	ALV-05-M10x27	AASN-3-0005	AAY-04	ACK-09	AAV-05-M6x15	AAL-05-4
4040 S19C	●	●	40	40	250	35								
4040 S25C	●	○	40	40	250	35	SNM. 2509..	APL-06	ALV-06-M12x36	AASN-3-0020	AAY-05	ACK-04	AKV-16-M6x16	AAL-07-5
5050 S25C	○	○	50	50	250	43								

R: Sağ/Right L: Sol/Left ● Stokta/In Stock ○ Stokta Yok/Non Stock Item

Sipariş Örneği/Ordering Example : 1 ad./pcs. PDN1616 H11

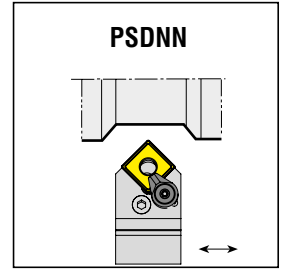
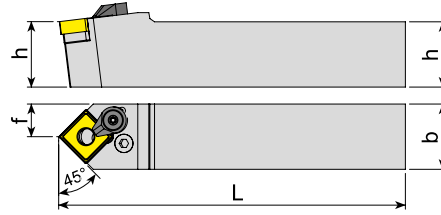

Takım Kodu Ordering Code	Stok Stock	Takım Ölçüleri (mm) Dimension (mm)				Kesici Uç Insert	Yedek Parçaları Spare Parts						
		h	b	L	f		Levyeye	Levyeye Vidası	Altılık	Altılık Yayı	Baskı Parçası	Baskı Vidası	Anahtar
							Lever	Lever Screw	Shim	Shim Spring	Wedge Clamp	Clamp Screw	Allen Key
PSDNN 1616 H09	●	16	16	100	8	SNM. 0903..	APL-01	ALV-02-M6x17	AASN-2-0002	AAY-01	-	-	AAL-02-2.5
2020 K12C	●	20	20	125	10	SNM. 1204..	APL-02	ALV-03-M8x19	AASN-3-0004	AAY-02	ACK-05	1515-M4x11	AAL-03-3
2525 M12C	●	25	25	150	12.5								
3232 P12C	●	32	32	170	16								
2020 K15C	○	20	20	125	10	SNM. 1506..	APL-04	ALV-04-M8x22	AASN-3-0023	AAY-03	ACK-09	AAV-05-M6x15	AAL-05-4
2525 M15C	●	25	25	150	12.5								
3232 P19C	●	32	32	170	16								
4040 S19C	○	40	40	250	20	SNM. 1906..	APL-05	ALV-05-M10x27	AASN-3-0005	AAY-04	ACK-09	AAV-05-M6x15	AAL-05-4
5050 S19C	○	50	50	250	25								
4040 S25C	●	40	40	250	20	SNM. 2509..	APL-06	ALV-06-M12x36	AASN-3-0020	AAY-05	ACK-04	AKV-16-M6x16	AAL-07-5
5050 S25C	○	50	50	250	25								

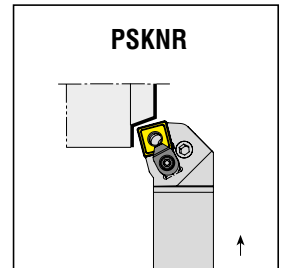
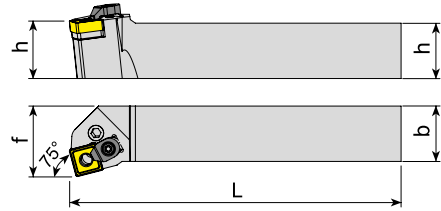

Takım Kodu Ordering Code	Stok Stock		Takım Ölçüleri (mm) Dimension (mm)				Kesici Uç Insert	Yedek Parçaları Spare Parts						
	R	L	h	b	L	f		Levyeye	Levyeye Vidası	Altılık	Altılık Yayı	Baskı Parçası	Baskı Vidası	Anahtar
								Lever	Lever Screw	Shim	Shim Spring	Wedge Clamp	Clamp Screw	Allen Key
PSKNR/L 2020 K09	●	○	20	20	125	25	SNM. 0903..	APL-01	ALV-02-M6x17	AASN-2-0002	AAY-01	-	-	AAL-02-2.5
2020 K12C	●	●	20	20	125	25	SNM. 1204..	APL-02	ALV-03-M8x19	AASN-3-0004	AAY-02	ACK-05	1515-M4x11	AAL-03-3
2525 M12C	●	●	25	25	150	32								
3232 P12C	●	●	32	32	170	40								
2525 M15C	●	●	25	25	150	32	SNM. 1506..	APL-04	ALV-04-M8x22	AASN-3-0023	AAY-03	ACK-09	AAV-05-M6x15	AAL-05-4
3232 P15C	●	○	32	32	170	40								
3232 P19C	●	○	32	32	170	40								
4040 S19C	●	○	40	40	250	50	SNM. 1906..	APL-05	ALV-05-M10x27	AASN-3-0005	AAY-04	ACK-09	AAV-05-M6x15	AAL-05-4
4040 S25C	●	○	40	40	250	50								
5050 S25C	●	○	50	50	250	60	SNM. 2509..	APL-06	ALV-06-M12x36	AASN-3-0020	AAY-05	ACK-04	AKV-16-M6x16	AAL-07-5

R: Sağ/Right L: Sol/Left ● Stokta/In Stock ○ Stokta Yok/Non Stock Item

Sipariş Örneği/Ordering Example : 1 ad./pcs. PSDNN 1616 H09

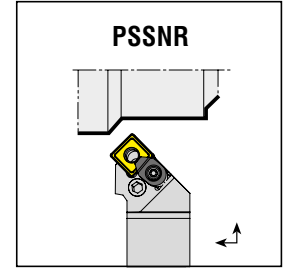
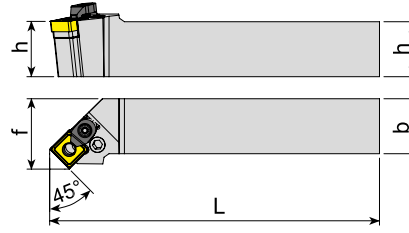

Takım Kodu Ordering Code	Stok Stock		Takım Ölçüleri (mm) Dimension (mm)				Kesici Uç Insert	Yedek Parçaları Spare Parts						
	R	L	h	b	L	f		Levye Lever	Levye Vidası Lever Screw	Altlık Shim	Altlık Yayı Shim Spring	Baskı Parçası Wedge Clamp	Baskı Vidası Clamp Screw	Anahtar Allen Key
PSSNR/L 1616 H09	●	●	16	16	100	20	SNM. 0903..	APL-01	ALV-02-M6x17	AASN-2-0002	AAV-01	-	-	AAL-02-2.5
2020 K09	●	○	20	20	125	25								
2020 K12C	●	●	20	20	125	25	SNM. 1204..	APL-02	ALV-03-M8x19	AASN-3-0004	AAV-02	ACK-05	1515-M4x11	AAL-03-3
2525 M12C	●	●	25	25	150	32								
3232 P12C	●	●	32	32	170	40	SNM. 1506..	APL-04	ALV-04-M8x22	AASN-3-0023	AAV-03	ACK-09	AAV-05-M6x15	AAL-05-4
3232 P15C	○	○	32	32	170	40								
3232 P19C	●	●	32	32	170	40	SNM. 1906..	APL-05	ALV-05-M10x27	AASN-3-0005	AAV-04	ACK-04	AKV-16-M6x16	AAL-07-5
4040 S19C	●	●	40	40	250	50								
4040 S25C	●	●	40	40	250	50	SNM. 2509..	APL-06	ALV-06-M12x36	AASN-3-0020	AAV-05	ACK-04	AKV-16-M6x16	AAL-07-5

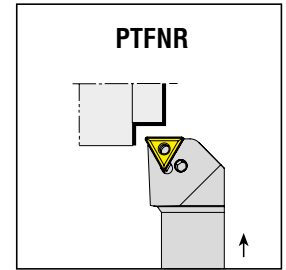
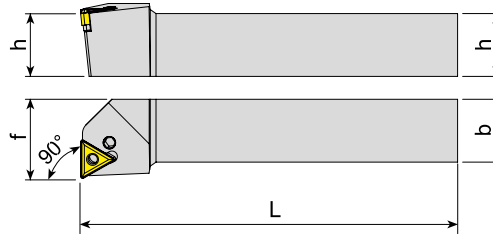

Takım Kodu Ordering Code	Stok Stock		Takım Ölçüleri (mm) Dimension (mm)				Kesici Uç Insert	Yedek Parçaları Spare Parts						
	R	L	h	b	L	f		Levye Lever	Levye Vidası Lever Screw	Altlık Shim	Altlık Yayı Shim Spring	Baskı Parçası Wedge Clamp	Baskı Vidası Clamp Screw	Anahtar Allen Key
PTFNR/L 1616 H16	●	●	16	16	100	20	TNM. 1604..	APL-01	ALV-02-M6x17	AATN-3-0025	AAV-01	-	-	AAL-02-2.5
2020 K16	●	●	20	20	125	25								
2525 M16	●	●	25	25	150	32								
3232 P16	●	●	32	32	170	40								
2525 M22C	●	●	25	25	150	32	TNM. 2204..	APL-02	ALV-03-M8x19	AATN-3-0015	AAV-02	ACK-05	1515-M4x11	AAL-03-3
3232 P22C	●	●	32	32	170	40								
4040 S27	○	○	40	40	250	50	TNM. 2706.	07042709	07042710	07042701	07042711	-	-	AAL-05-4

R: Sağ/Right L: Sol/Left ● Stokta/In Stock ○ Stokta Yok/Non Stock Item

Sipariş Örneği/Ordering Example : 1 ad./pcs. PSSNR 1616 H09

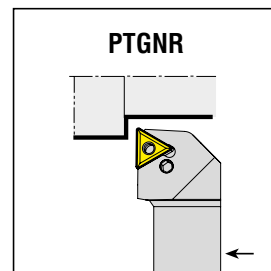
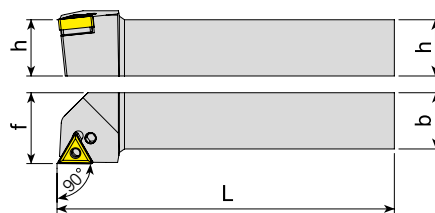

Takım Kodu Ordering Code	Stok Stock		Takım Ölçüleri (mm) Dimension (mm)				Kesici Uç Insert	Yedek Parçaları Spare Parts							
	R	L	h	b	L	f		Levyeye Lever	Levyeye Vidası Lever Screw	Altılık Shim	Altılık Yayı Shim Spring	Baskı Parçası Wedge Clamp	Baskı Vidası Clamp Screw	Anahtar Allen Key	
PTGNER/L 1010 E11	○	○	10	10	70	12			07041109	07041110	-	-	-	-	-
1212 F11	○	○	12	12	80	16									
1616 H11	○	○	16	16	100	20									
1616 H16	●	●	16	16	100	20	TNM. 1604..	APL-01	ALV-02-M6x17	AATN-3-0025	AAY-01	-	-	-	AAL-02-2.5
2020 K16	●	●	20	20	125	25									
2525 M16	●	●	25	25	150	32									
3232 P16	○	○	32	32	170	40	TNM. 2204..	APL-02	ALV-03-M8x19	AATN-3-0015	AAY-02	ACK-05	1515-M4x11	AAL-03-3	
2525 M22C	●	●	25	25	150	32									
3232 P22C	●	●	32	32	170	40									
4040 S27	○	○	40	40	250	50	TNM. 2706..	07042709	07042710	07042701	07042711	-	-	AAL-05-4	

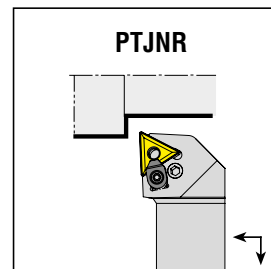
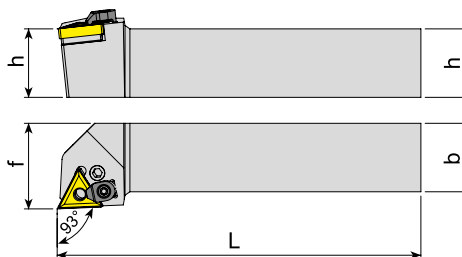

Takım Kodu Ordering Code	Stok Stock		Takım Ölçüleri (mm) Dimension (mm)				Kesici Uç Insert	Yedek Parçaları Spare Parts							
	R	L	h	b	L	f		Levyeye Lever	Levyeye Vidası Lever Screw	Altılık Shim	Altılık Yayı Shim Spring	Baskı Parçası Wedge Clamp	Baskı Vidası Clamp Screw	Anahtar Allen Key	
PTJNER/L 1010 E11	○	○	10	10	70	12			07041109	07041110	-	-	-	-	-
1212 F11	○	○	12	12	80	16									
1616 H11	○	○	16	16	100	20									
1616 H16	●	●	16	16	100	20	TNM. 1604..	APL-01	ALV-02-M6x17	AATN-3-0025	AAY-01	-	-	-	AAL-02-2.5
2020 K16	●	●	20	20	125	25									
2525 M16	●	●	25	25	150	32									
3232 P16	●	●	32	32	170	40	TNM. 2204..	APL-02	ALV-03-M8x19	AATN-3-0015	AAY-02	ACK-5	1515-M4x11	AAL-03-3	
2525 M22C	●	●	25	25	150	32									
3232 P22C	●	●	32	32	170	40									
4040 S27	○	○	40	40	250	50	TNM. 2706..	07042709	07042710	07042701	07042711	-	-	AAL-05-4	

R: Sağ/Right L: Sol/Left ● Stokta/In Stock ○ Stokta Yok/Non Stock Item

Sipariş Örneği/Ordering Example : 1 ad./pcs. PTGNER 1010 E11

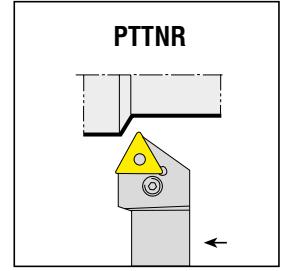
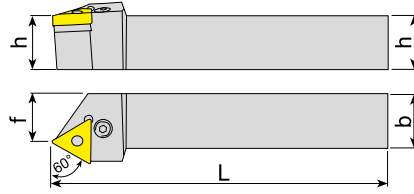

Takım Kodu Ordering Code	Stok Stock		Takım Ölçüleri (mm) Dimension (mm)				Kesici Uç Insert	Yedek Parçaları Spare Parts						
	R	L	h	b	L	f		Levyeye	Levyeye	Altılık	Altılık	Baskı	Baskı	Anahtar
								Lever	Lever Screw	Shim	Shim Spring	Wedge Clamp	Clamp Screw	Allen Key
PTTNR/L 1616 H16	●	●	16	16	100	13						-	-	AAL-02-2.5
2020 K16	●	●	20	20	125	17								
2525 M16	●	●	25	25	150	21.5								
3232 P16	●	●	32	32	170	31								
2525 M22C	●	●	25	25	150	20.5						ACK-05	1515-M4x11	AAL-03-3
3232 P22C	●	●	32	32	170	29								

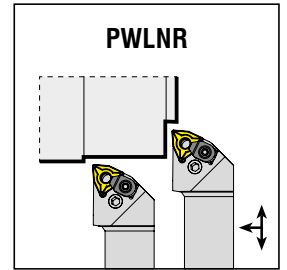
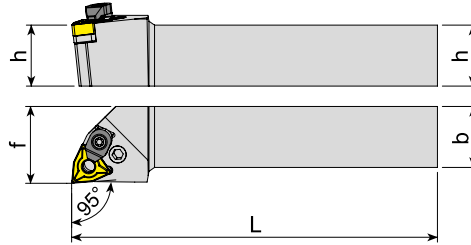

Takım Kodu Ordering Code	Stok Stock		Takım Ölçüleri (mm) Dimension (mm)				Kesici Uç Insert	Yedek Parçaları Spare Parts						
	R	L	h	b	L	f		Levyeye	Levyeye	Altılık	Altılık	Baskı	Baskı	Anahtar
								Lever	Lever Screw	Shim	Shim Spring	Wedge Clamp	Clamp Screw	Allen Key
PWLNR/L 1616 H06	●	●	16	16	100	20						-	-	AAL-02-2.5
2020 K06	●	●	20	20	125	25								
2525 M06	●	●	25	25	150	32								
3232 P06	○	○	32	32	170	40								
1616 H08	●	●	16	16	100	20						ACK-05	1515-M4x11	AAL-03-3
2020 K08C	●	●	20	20	125	25								
2525 M08C	●	●	25	25	150	32								
3232 P08C	●	●	32	32	170	40								

R: Sağ/Right L: Sol/Left ● Stokta/In Stock ○ Stokta Yok/Non Stock Item

Sipariş Örneği/Ordering Example : 1 ad./pcs. PTTNR 1616 H16

konusulan
the spoken kalite...
quality...





*konusulan
the spoken kalite...
quality...*

C-SİSTEM

C-SİSTEM DIŞ TORNA KATERLERİ

C-SYSTEM EXTERNAL TURNING TOOLHOLDERS



www.akkо.com.tr

Дистрибьютер ООО "Ресурс Плюс"
+7 (351) 247-74-40; info@rp-ural.ru

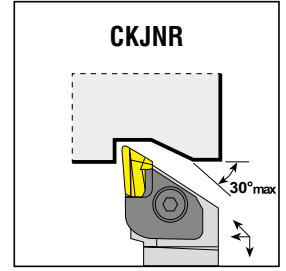
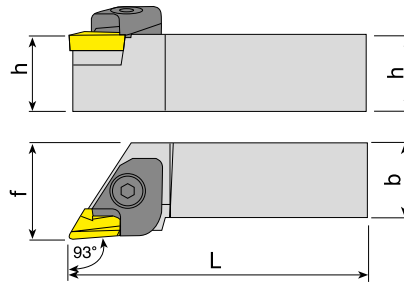

Takım Kodu Ordering Code	Stok Stock		Takım Ölçüleri (mm) Dimension (mm)				Kesici Uç Insert	Yedek Parçaları Spare Parts													
	R	L	h	b	L	f		Baskı Pabucu Wedge Clamp	Pabuç Vidası Clamp Screw	Altlık Shim	Altlık Vidası Shim Screw	Yay Spring	Pul Stamp	Anahtar Allen Key							
CKJNR/L 2020 K16	●	●	20	20	125	27.5	KNUX 1604..														
2525 M16	●	●	25	25	150	31.5									ACK-01-R	AKV-06-M6x20	AKS-16-R	AAV-01-M3x10	AKY-02	ABPL-01	AAL-05-4
3232 P16	●	●	32	32	170	40									ACK-02-L		AKS-16-L				
4040 S16	●	●	40	40	250	50															

C-SİSTEM SERAMİK UÇLAR İÇİN DIŞ TORNA KATERLERİ
C-SYSTEM EXTERNAL TURNING TOOLHOLDERS FOR CERAMIC INSERTS

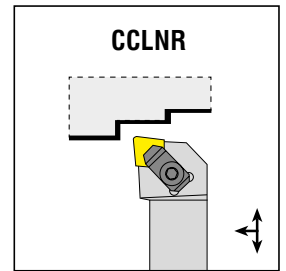
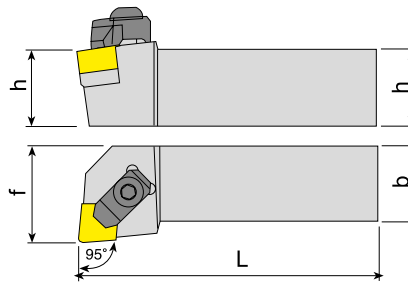

Takım Kodu Ordering Code	Stok Stock		Takım Ölçüleri (mm) Dimension (mm)				Kesici Uç Insert	Yedek Parçaları Spare Parts											
	R	L	h	b	L	f		Baskı Pabucu Wedge Clamp	Pabuç Vidası Clamp Screw	Altlık Shim	Altlık Vidası Shim Screw	Sekman Ring	Anahtar Allen Key						
CCLNR/L 2525 M1207C	●	●	25	25	150	32	CN.N 1207..												
3232 P1207C	●	●	32	32	170	40								ACK-13	AKV-11-M8x29	AACN-3-0001	AAV-02-M5x12	ACS-01	AAL-05-4
2525 M1607C	●	●	25	25	150	32								ACK-13	AKV-11-M8x29	AACN-3-0002	AAV-05-M6x15	ACS-01	AAL-05-4

R: Sağ/Right L: Sol/Left ● Stokta/In Stock ○ Stokta Yok/Non Stock Item

Sipariş Örneği/Ordering Example : 1 ad./pcs. CKJNR 2020 K16

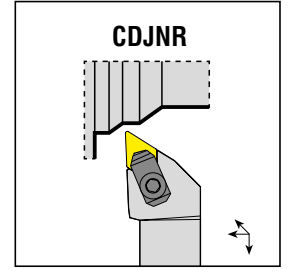
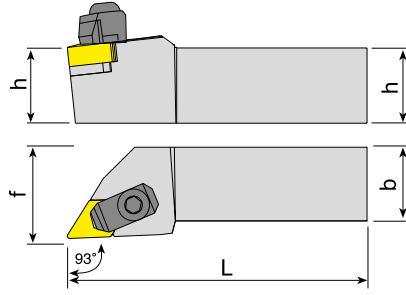

Takım Kodu Ordering Code	Stok Stock		Takım Ölçüleri (mm) Dimension (mm)				Kesici Uç Insert	Yedek Parçaları Spare Parts					
	R	L	h	b	L	f		Baskı Pabucu Wedge Clamp	Pabuç Vidası Clamp Screw	Altık Shim	Altık Vidası Shim Screw	Sekman Ring	Anahtar Allen Key
CDJNR/L 2525 M1107C	●	●	25	25	150	32	DN.N 1107..	ACK-22	AKV-11-M8x29	AADN-2-0001	AAV-04-M5x12	ACS-01	AAL-05-4
2525 M1507C	●	●	25	25	150	32	DN.N 1507..	ACK-13	AKV-11-M8x29	AADN-3-0001	AAV-02-M5x12	ACS-01	AAL-05-4
3232 P1507C	●	●	32	32	170	40							

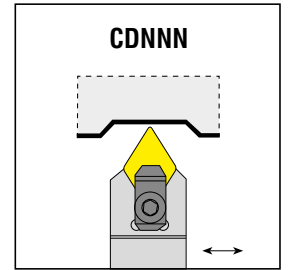
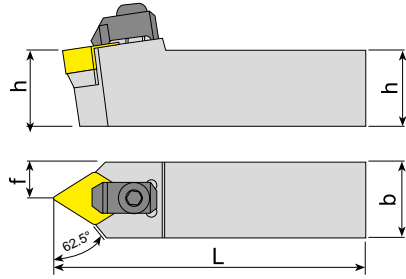

Takım Kodu Ordering Code	Stok Stock		Takım Ölçüleri (mm) Dimension (mm)				Kesici Uç Insert	Yedek Parçaları Spare Parts					
	R	L	h	b	L	f		Baskı Pabucu Wedge Clamp	Pabuç Vidası Clamp Screw	Altık Shim	Altık Vidası Shim Screw	Sekman Ring	Anahtar Allen Key
CDNNN 2525 M1107C	●		25	25	150	12.5	DN.N 1107..	ACK-22	AKV-11-M8x29	AADN-2-0001	AAV-04-M5x12	ACS-01	AAL-05-4

R: Sağ/Right L: Sol/Left ● Stokta/In Stock ○ Stokta Yok/Non Stock Item

Sipariş Örneği/Ordering Example : 1 ad./pcs. CDJNR 2525 M1507C

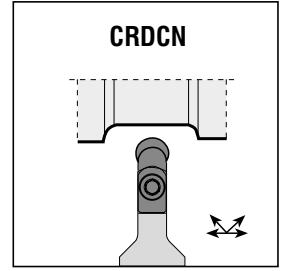
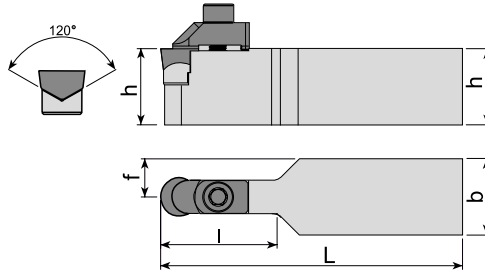

Takım Kodu Ordering Code	Stok Stock	Takım Ölçüleri (mm) Dimension (mm)					Kesici Uç Insert	Yedek Parçaları Spare Parts				
		h	b	L	l	f		Baskı Pabucu Wedge Clamp	Pabuç Vidası Clamp Screw	Altık Shim	Altık Vidası Shim Screw	Anahtar Allen Key
CRDCN 2525 M06CV	●	25	25	150	19	12.5	RCGX 060600					
3225 P06CV	●	32	25	170	19	12.5						
4040 S06CV	●	40	40	250	19	20						
2525 M09CV	●	25	25	150	29	12.5	RCGX 090700					
3225 P09CV	●	32	25	170	29	12.5						
4040 S09CV	●	40	40	250	29	20						
2525 M12CV	●	25	25	150	38	12.5	RCGX 120700					
3225 P12CV	●	32	25	170	38	12.5						
4040 S12CV	●	40	40	250	38	20						

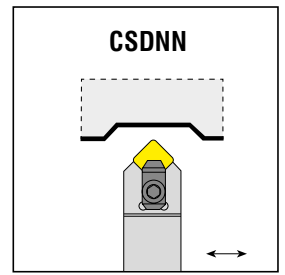
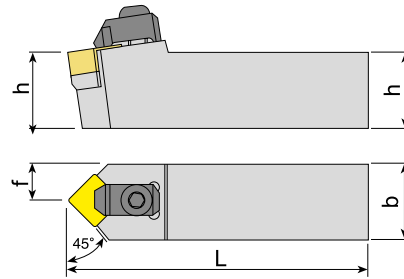

Takım Kodu Ordering Code	Stok Stock	Takım Ölçüleri (mm) Dimension (mm)				Kesici Uç Insert	Yedek Parçaları Spare Parts					
		h	b	L	f		Baskı Pabucu Wedge Clamp	Pabuç Vidası Clamp Screw	Altık Shim	Altık Vidası Shim Screw	Sekman Ring	Anahtar Allen Key
CSDNN 2525 M1207C	●	25	25	150	12.5	SN.N 1207..						
3232 P1207C	●	32	32	170	16							

R: Sağ/Right L: Sol/Left ● Stokta/In Stock ○ Stokta Yok/Non Stock Item

Sipariş Örneği/Ordering Example : 1 ad./pcs. CRDCN 2525 M06CV

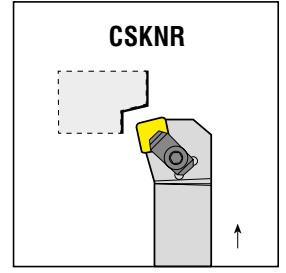
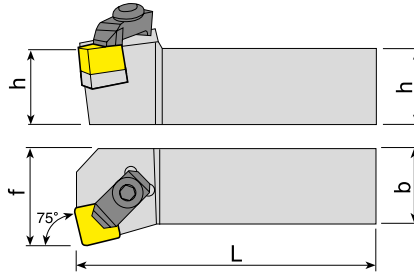
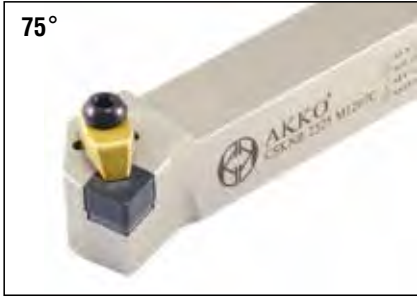

Takım Kodu Ordering Code	Stok Stock		Takım Ölçüleri (mm) Dimension (mm)				Kesici Uç Insert	Yedek Parçaları Spare Parts					
	R	L	h	b	L	f		Baskı Pabucu Wedge Clamp	Pabuç Vidası Clamp Screw	Altlık Shim	Altlık Vidası Shim Screw	Sekman Ring	Anahtar Allen Key
CSKNR/L 2525 M1207C	●	●	25	25	150	32	SN.N 1207..						
3232 P1207C	●	●	32	32	170	40							

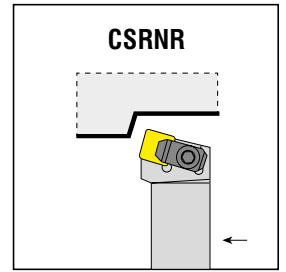
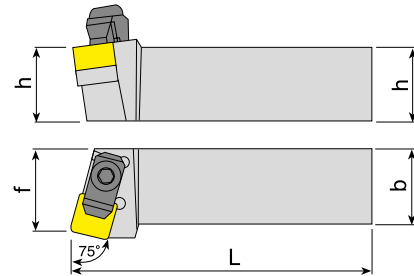

Takım Kodu Ordering Code	Stok Stock		Takım Ölçüleri (mm) Dimension (mm)				Kesici Uç Insert	Yedek Parçaları Spare Parts					
	R	L	h	b	L	f		Baskı Pabucu Wedge Clamp	Pabuç Vidası Clamp Screw	Altlık Shim	Altlık Vidası Shim Screw	Sekman Ring	Anahtar Allen Key
CSRNR/L 2525 M1207C	●	●	25	25	150	32	SN.N 1207..						
3232 P1207C	●	○	32	32	170	40							

R: Sağ/Right L: Sol/Left ● Stokta/In Stock ○ Stokta Yok/Non Stock Item

Sipariş Örneği/Ordering Example : 1 ad./pcs. CSKNR 2525 M1207C

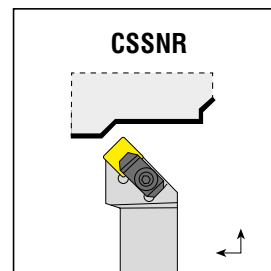
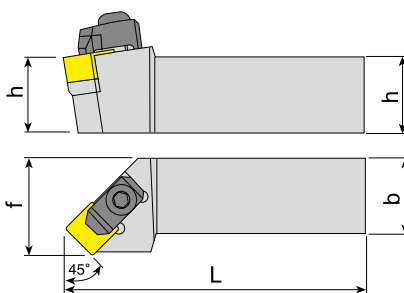

Takım Kodu Ordering Code	Stok Stock		Takım Ölçüleri (mm) Dimension (mm)				Kesici Uç Insert	Yedek Parçaları Spare Parts					
	R	L	h	b	L	f		Baskı Pabucu Wedge Clamp	Pabuç Vidası Clamp Screw	Altlık Shim	Altlık Vidası Shim Screw	Sekman Ring	Anahtar Allen Key
CSSNR/L 2525 M1207C	●	●	25	25	150	32	SN.N 1207..						
3232 P1207C	●	●	32	32	170	40							

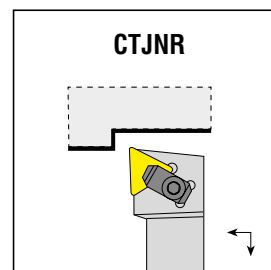
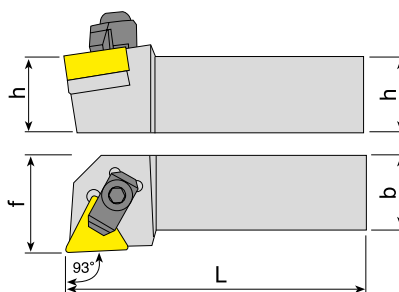

Takım Kodu Ordering Code	Stok Stock		Takım Ölçüleri (mm) Dimension (mm)				Kesici Uç Insert	Yedek Parçaları Spare Parts					
	R	L	h	b	L	f		Baskı Pabucu Wedge Clamp	Pabuç Vidası Clamp Screw	Altlık Shim	Altlık Vidası Shim Screw	Sekman Ring	Anahtar Allen Key
CTJNR/L 2525 M1607C	●	●	25	25	150	32	TN.N 1607..						
3232 P1607C	○	○	32	32	170	40							

R: Sağ/Right L: Sol/Left ● Stokta/In Stock ○ Stokta Yok/Non Stock Item

Sipariş Örneği/Ordering Example : 1 ad./pcs. CSSNR 2525 M1207C



*konusulan
the spoken kalite...
quality...*

S-SİSTEM

S-SİSTEM DIŞ TORNA KATERLERİ

S-SYSTEM EXTERNAL TURNING TOOLHOLDERS



www.akkо.com.tr

Дистрибьютер ООО "Ресурс Плюс"
+7 (351) 247-74-40; info@rp-ural.ru

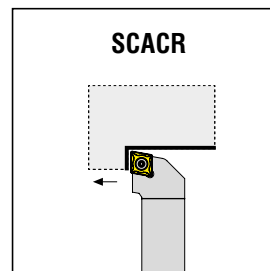
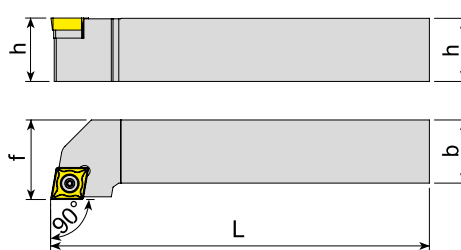

Takım Kodu Ordering Code	Stok Stock		Takım Ölçüleri (mm) Dimension (mm)				Kesici Uç Insert	Yedek Parçaları Spare Parts			
	R	L	h	b	L	f		Sıkma Vidası Screw	Altlık Shim	Altlık Vidası Shim Screw	Tork Anahtar Torx Key
SCACR/L 0808 E06	●	●	08	08	70	10	CCM. 0602..	4008-M2.5x6	-	-	80-T08
1010 E06	●	●	10	10	70	12					
1212 F09	●	●	12	12	80	16					
1616 H09	●	●	16	16	100	20	CCM. 09T3..	4015-M3.5x11	AACN-2-0001	AAV-06-M3.5x11	80-T15
2020 K09	●	●	20	20	125	25					
2020 K12	●	●	20	20	125	25	CCM. 1204..	1020-M4.5x16	AACN-2-0003	AAV-07-M4.5x13	80-T20
2525 M12	●	●	25	25	150	32					

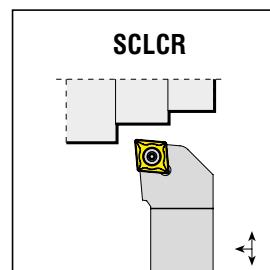
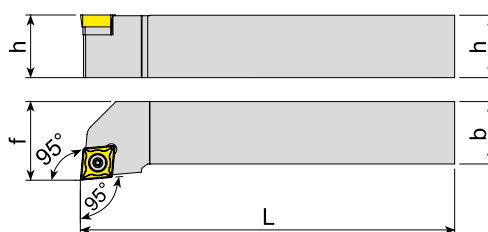

Takım Kodu Ordering Code	Stok Stock		Takım Ölçüleri (mm) Dimension (mm)				Kesici Uç Insert	Yedek Parçaları Spare Parts			
	R	L	h	b	L	f		Sıkma Vidası Screw	Altlık Shim	Altlık Vidası Shim Screw	Tork Anahtar Torx Key
SCLCR/L 0808 E06	●	●	08	08	70	10	CCM. 0602..	4008-M2.5x6	-	-	80-T08
1010 E06	●	●	10	10	70	12					
1212 F09	●	●	12	12	80	16					
1616 H09	●	●	16	16	100	20	CCM. 09T3..	4015-M3.5x11	AACN-2-0001	AAV-06-M3.5x11	80-T15
2020 K09	●	●	20	20	125	25					
2525 M09	●	●	25	25	150	32	CCM. 1204..	1020-M4.5x16	AACN-2-0003	AAV-07-M4.5x13	80-T20
2020 K12	●	●	20	20	125	25					
2525 M12	●	●	25	25	150	32					

R: Sağ/Right L: Sol/Left ● Stokta/In Stock ○ Stokta Yok/Non Stock Item

Sipariş Örneği/Ordering Example : 1 ad./pcs. SCACR 0808 E06

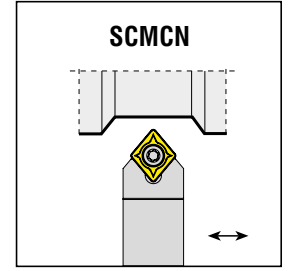
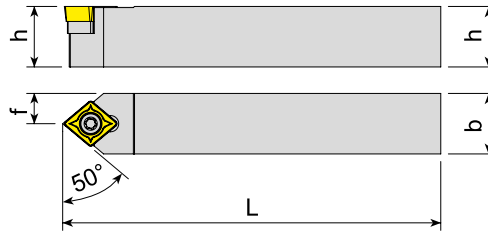

Takım Kodu Ordering Code	Stok Stock	Takım Ölçüleri (mm) Dimension (mm)				Kesici Uç Insert	Yedek Parçaları Spare Parts			
		h	b	L	f		Sıkma Vidası Screw	Aitlik Shim	Aitlik Vidası Shim Screw	Tork Anahtar Torx Key
SCMCN 0808 E06	●	08	08	70	04					
1010 E06	●	10	10	70	05					
1212 F06	●	12	12	80	06					
1212 F09	●	12	12	80	06	CCM. 09T3..	4015-M3.5x11	-	-	80-T15
1616 H09	●	16	16	100	08					
2020 K12	●	20	20	125	10	CCM. 1204..	1020-M4.5x16	AACN-2-0003	AAV-07-M4.5x13	80-T20
2525 M12	●	25	25	150	12.5					

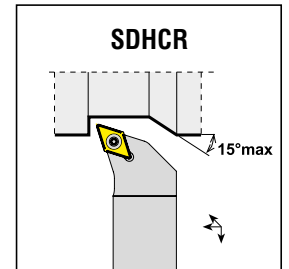
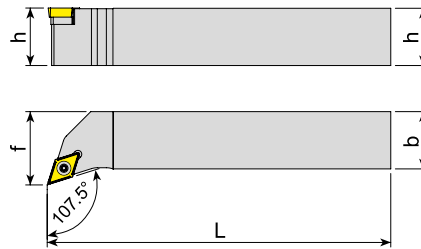

Takım Kodu Ordering Code	Stok Stock		Takım Ölçüleri (mm) Dimension (mm)				Kesici Uç Insert	Yedek Parçaları Spare Parts			
	R	L	h	b	L	f		Sıkma Vidası Screw	Aitlik Shim	Aitlik Vidası Shim Screw	Tork Anahtar Torx Key
SDHCR/L 0808 E07	●	●	08	08	70	11					
1010 E07	●	●	10	10	70	12					
1212 F07	●	●	12	12	80	16					
1616 H07	●	●	16	16	100	20					
1616 H11	●	●	16	16	100	20	DCM. 11T3..	4015-M3.5x14	AADN-2-0001	AAV-06-M3.5x11	80-T15
2020 K11	●	●	20	20	125	25					
2525 M11	●	●	25	25	150	32					
3232 P11	●	●	32	32	170	40					

R: Sağ/Right L: Sol/Left ● Stokta/In Stock ○ Stokta Yok/Non Stock Item

Sipariş Örneği/Ordering Example : 1 ad./pcs. SCMCN 0808 E06

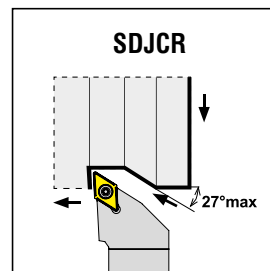
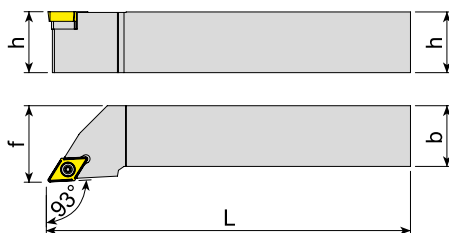

Takım Kodu Ordering Code	Stok Stock		Takım Ölçüleri (mm) Dimension (mm)				Kesici Uç Insert	Yedek Parçaları Spare Parts			
	R	L	h	b	L	f		Sıkma Vidası Screw	Aitlik Shim	Aitlik Vidası Shim Screw	Tork Anahtar Torx Key
SDJCR/L 0808 E07	●	●	08	08	70	10					
1010 E07	●	●	10	10	70	12					
1212 F07	●	●	12	12	80	16					
1616 H07	●	●	16	16	100	20					
1616 H11	●	●	16	16	100	20					
2020 K11	●	●	20	20	125	25					
2525 M11	●	●	25	25	150	32					
3232 P11	●	●	32	32	170	40					

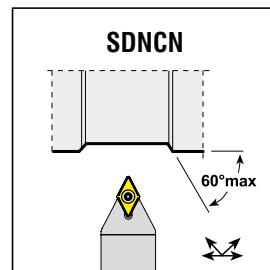
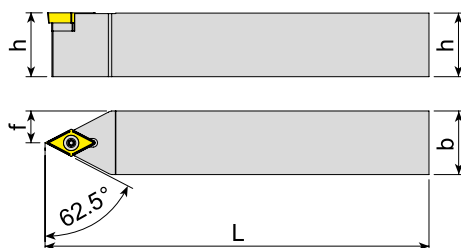

Takım Kodu Ordering Code	Stok Stock		Takım Ölçüleri (mm) Dimension (mm)				Kesici Uç Insert	Yedek Parçaları Spare Parts			
	R	L	h	b	L	f		Sıkma Vidası Screw	Aitlik Shim	Aitlik Vidası Shim Screw	Tork Anahtar Torx Key
SDNCN 0808 E07	●	●	08	08	70	4					
1010 E07	●	●	10	10	70	5					
1212 F07	●	●	12	12	80	6					
1616 H07	●	●	16	16	100	8					
1616 H11	●	●	16	16	100	8					
2020 K11	●	●	20	20	125	10					
2525 M11	●	●	25	25	150	12.5					
3232 P11	●	●	32	32	170	16					

R: Sağ/Right L: Sol/Left ● Stokta/In Stock ○ Stokta Yok/Non Stock Item

Sipariş Örneği/Ordering Example : 1 ad./pcs. SDJCR 0808 E07

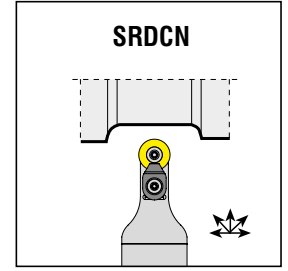
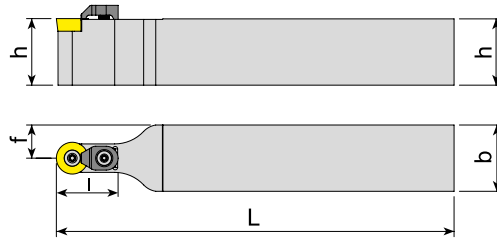

Takım Kodu Ordering Code	Stok Stock	Takım Ölçüleri (mm) Dimension (mm)					Kesici Uç Insert	Yedek Parçaları Spare Parts					
		h	b	L	l	f		Sıkma Vidası Screw	Altlık Shim	Altlık Vidası Shim Screw	Baskı Parçası Wedge Clamp	Baskı Vidası Clamp Screw	Tork Anahtar Torx Key
SRDCN 1616 H06	●	16	16	100	15	8							
2020 K06	●	20	20	125	17	10	RC.T 0602..	4008-M2.5x6	-	-	-	-	
2525 M06	●	25	25	150	17	12.5							80-T08
1616 H08C	●	16	16	100	15	8			-	-			
2020 K08C	●	20	20	125	20	10	RC.T 0803..	1008-M3x8	-	-			
2525 M08C	●	25	25	150	20	12.5							
1616 H10C	●	16	16	100	20	8			-	-	ACK-15	1015-M3.5x11	
2020 K10C	●	20	20	125	20	10	RC.T 10T3..	4015-M3.5x11	-	-			
2525 M10C	●	25	25	150	20	12.5							
3232 P10C	●	32	32	170	20	16							
2020 K12C	●	20	20	125	22	10			-	-			
2525 M12C	●	25	25	150	22	12.5	RC.T 1204..	4015-M3.5x11	-	-			
3232 P12C	●	32	32	170	22	16							
2525 M16C	●	25	25	150	32	12.5			-	-	ACK-05	1515-M4x11	
3232 P16C	●	32	32	170	35	16	RC.T 1605..	1020-M5x11	-	-			
2525 M20C	●	25	25	150	32	12.5			-	-			
3232 P20C	●	32	32	170	40	16	RC.T 2006..	1420-M6x16	-	-	ACK-09	AAV-05-M6x15	
3232 P25C	●	32	32	170	40	16	RC.T 2507..	1520-M6x16					
3232 P32C	●	32	32	170	45	16	RC.T 3209..	1904-M8x1x20					AAL-05-4

R: Sağ/Right L: Sol/Left ● Stokta/In Stock ○ Stokta Yok/Non Stock Item

Sipariş Örneği/Ordering Example : 1 ad./pcs. SRDCN 1616 H06



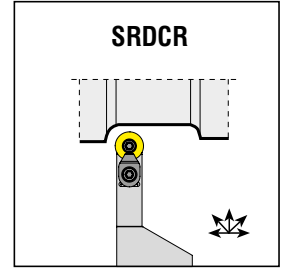
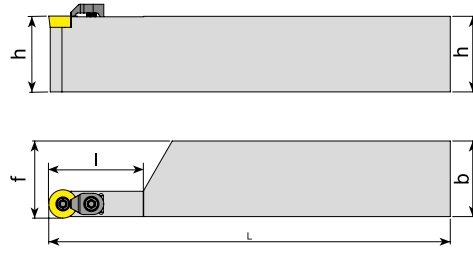

Takım Kodu Ordering Code	Stok Stock		Takım Ölçüleri (mm) Dimension (mm)					Kesici Uç Insert	Yedek Parçaları Spare Parts					
	R	L	h	b	L	l	f		Sıkma Vidası Screw	Altılık Shim	Altılık Vidası Shim Screw	Baskı Parçası Wedge Clamp	Baskı Vidası Clamp Screw	Tork Anahtar Torx Key
SRDCR/L 3232 P12C	●	●	32	32	170	40	32.6			-	-			

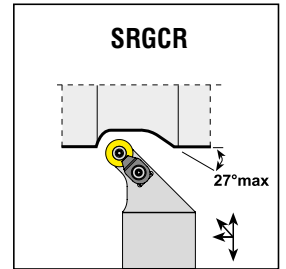
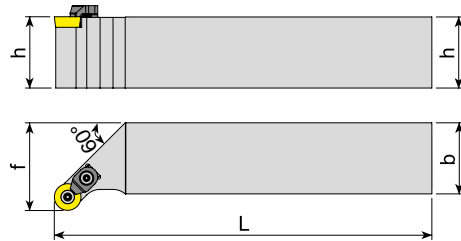

Takım Kodu Ordering Code	Stok Stock		Takım Ölçüleri (mm) Dimension (mm)					Kesici Uç Insert	Yedek Parçaları Spare Parts					
	R	L	h	b	L	f	Sıkma Vidası Screw		Altılık Shim	Altılık Vidası Shim Screw	Baskı Parçası Wedge Clamp	Baskı Vidası Clamp Screw	Tork Anahtar Torx Key	
SRGCR/L 1616 H06	●	●	16	16	100	20	RC.T 0602..	4008-M2.5x6	-	-	-	-	80-T08	
2020 K06	●	●	20	20	125	25								
1616 H08C	●	●	16	16	100	20	RC.T 0803..	1008-M3x8	-	-	ACK-15	1015-M3.5x11	80-T15	
2020 K08C	●	●	20	20	125	25								
2525 M08C	●	●	25	25	150	32	RC.T 10T3..	4015-M3.5x11	-	-	ACK-05	1515-M4x11	80-T15	
1616 H10C	●	●	16	16	100	20								
2020 K10C	●	●	20	20	125	25								
2525 M10C	●	●	25	25	150	32								
3232 P10C	●	●	32	32	170	40	RC.T 1204..	4015-M3.5x11	-	-	ACK-05	1515-M4x11	80-T15	
2020 K12C	●	●	20	20	125	25								
2525 M12C	●	●	25	25	150	32								
3232 P12C	●	●	32	32	170	40								

R: Sağ/Right L: Sol/Left ● Stokta/In Stock ○ Stokta Yok/Non Stock Item

Sipariş Örneği/Ordering Example : 1 ad./pcs. SRDCR 3232 P12C

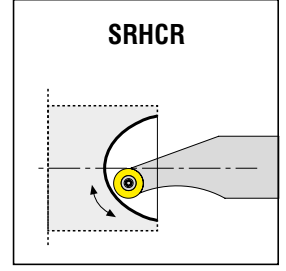
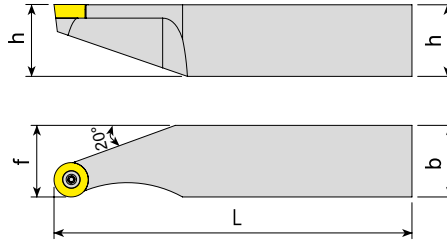

Takım Kodu Ordering Code	Stok Stock		Takım Ölçüleri (mm) Dimension (mm)				Kesici Uç Insert	Yedek Parçaları Spare Parts				
	R	L	h	b	L	f		min R	Sıkma Vidası Screw	Altık Shim	Altık Vidası Shim Screw	Tork Anahtar Torx Key
SRHCR/L 2525 K08	●	●	25	25	125	25	32.5	RCM. 0803..	1008-M3x8	-	-	80-T08
2525 K10	●	●	25	25	125	25	36	RCM. 10T3..	4015-M3.5x11	-	-	80-T15
2525 K12	●	●	25	25	125	25	40	RCM. 1204..		-	-	80-T15
2525 K16	●	●	25	25	125	25	47.5	RCM. 1606..	1020-M5x11	-	-	80-T20

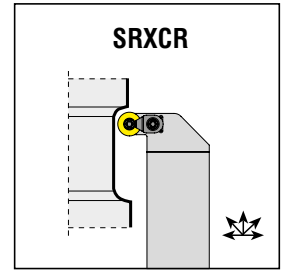
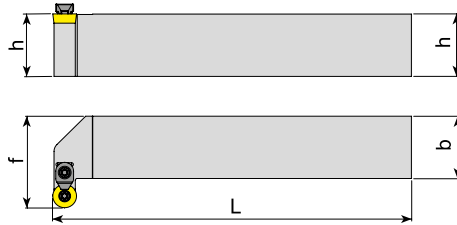

Takım Kodu Ordering Code	Stok Stock		Takım Ölçüleri (mm) Dimension (mm)				Kesici Uç Insert	Yedek Parçaları Spare Parts					
	R	L	h	b	L	f		Sıkma Vidası Screw	Altık Shim	Altık Vidası Shim Screw	Baskı Parçası Wedge Clamp	Baskı Vidası Clamp Screw	Tork Anahtar Torx Key
SRXCR/L 3232 X08C	●	●	32	32	220	47	RC.T 0803..	1008-M3x8	-	-	ACK-15	1015-M3.5x11	80-T08
3232 X10C	●	●	32	32	220	47	RC.T 10T3..	4015-M3.5x11	-	-	ACK-15	1015-M3.5x11	80-T15
3232 X12C	●	●	32	32	220	47	RC.T 1204..		-	-	ACK-05	1515-M4x11	80-T15

R: Sağ/Right L: Sol/Left ● Stokta/In Stock ○ Stokta Yok/Non Stock Item

Sipariş Örneği/Ordering Example : 1 ad./pcs. SRHCR 2525 K08

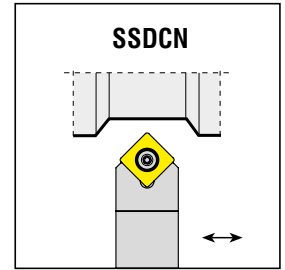
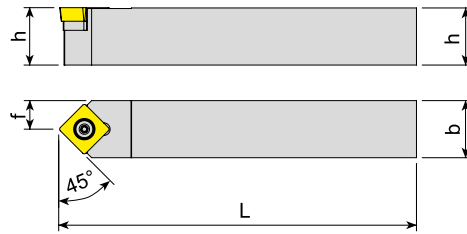

Takım Kodu Ordering Code	Stok Stock		Takım Ölçüleri (mm) Dimension (mm)				Kesici Uç Insert	Yedek Parçaları Spare Parts					
	R	L	h	b	L	f		Sıkma Vidası Screw	Altlık Shim	Altlık Vidası Shim Screw	Tork Anahtar Torx Key		
SSDCN 1212 F09	●		12	12	80	6			-	-			
1616 H09	●		16	16	100	8		SC.T 09T3..	4015-M3.5x14	AASN-2-0001		AAV-06-M3.5x11	80-T15
2020 K09	●		20	20	125	10		SC.T 1204..	4020-M4.5x12	AASN-2-0004		AAV-10-M4.5x8	80-T20
1616 H12	●		16	16	100	8	1020-M4.5x16		AAV-07-M4.5x13				
2020 K12	●		20	20	125	10							
2525 M12	●		25	25	150	12.5							

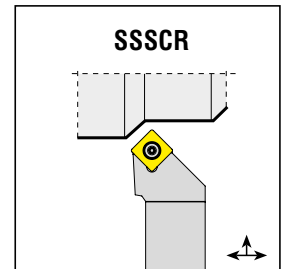
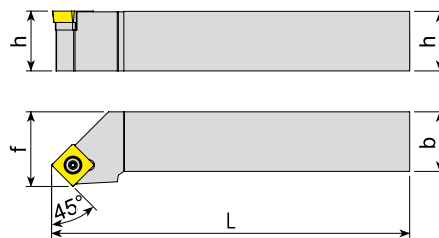

Takım Kodu Ordering Code	Stok Stock		Takım Ölçüleri (mm) Dimension (mm)				Kesici Uç Insert	Yedek Parçaları Spare Parts					
	R	L	h	b	L	f		Sıkma Vidası Screw	Altlık Shim	Altlık Vidası Shim Screw	Tork Anahtar Torx Key		
SSSCR/L 1212 F09	●	●	12	12	80	16			-	-			
1616 H09	●	●	16	16	100	20		SC.T 09T3..	4015-M3.5x14	AASN-2-0001		AAV-06-M3.5x11	80-T15
2020 K09	●	●	20	20	125	25		SC.T 1204..	4020-M4.5x12	AASN-2-0004		AAV-10-M4.5x8	80-T20
1616 H12	●	●	16	16	100	20	1020-M4.5x16		AAV-07-M4.5x13				
2020 K12	●	●	20	20	125	25							
2525 M12	●	●	25	25	150	32							

R: Sağ/Right L: Sol/Left ● Stokta/In Stock ○ Stokta Yok/Non Stock Item

Sipariş Örneği/Ordering Example : 1 ad./pcs. SSDCN 1212 F09

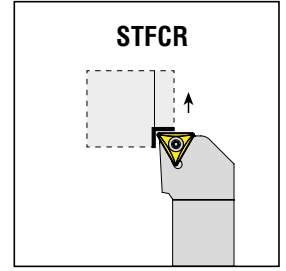
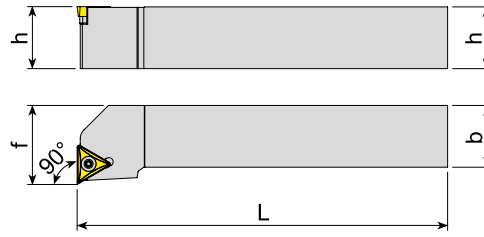

Takım Kodu Ordering Code	Stok Stock		Takım Ölçüleri (mm) Dimension (mm)				Kesici Uç Insert	Yedek Parçaları Spare Parts			
	R	L	h	b	L	f		Sıkma Vidası Screw	Altık Shim	Altık Vidası Shim Screw	Tork Anahtar Torx Key
STFCR/L 0808 E09	○	○	08	08	70	10					
1010 E09	●	●	10	10	70	12					
1212 F11	●	●	12	12	80	16					
1616 H11	●	●	16	16	100	20	TC.T 1102..	4008-M2.5x6			80-T08
1616 H16	●	●	16	16	100	20					
2020 K16	●	●	20	20	125	25	TC.T 16T3..	4015-M3.5x14	AATN-2-0001	AAV-06-M3.5x11	80-T15
2525 M16	●	●	25	25	150	32					
3232 P16	●	●	32	32	170	40					

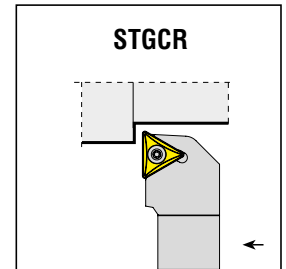
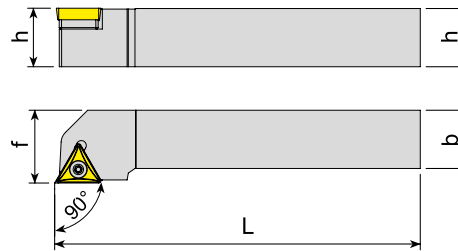

Takım Kodu Ordering Code	Stok Stock		Takım Ölçüleri (mm) Dimension (mm)				Kesici Uç Insert	Yedek Parçaları Spare Parts			
	R	L	h	b	L	f		Sıkma Vidası Screw	Altık Shim	Altık Vidası Shim Screw	Tork Anahtar Torx Key
STGCR/L 0808 E09	●	●	08	08	70	10					
1010 E09	●	●	10	10	70	12					
1212 F11	●	●	12	12	80	16					
1616 H11	●	●	16	16	100	20	TC.T 1102..	4008-M2.5x6			80-T08
1616 H16	○	○	16	16	100	20					
2020 K16	●	●	20	20	125	25	TC.T 16T3..	4015-M3.5x14	AATN-2-0001	AAV-06-M3.5x11	80-T15
2525 M16	●	●	25	25	150	32					
3232 P16	●	●	32	32	170	40					

R: Sağ/Right L: Sol/Left ● Stokta/In Stock ○ Stokta Yok/Non Stock Item

Sipariş Örneği/Ordering Example : 1 ad./pcs. STFCR 0808 E09

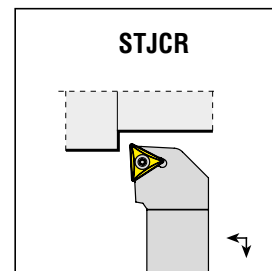
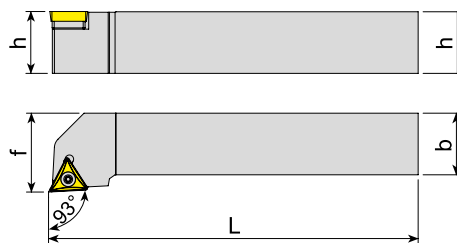

Takım Kodu Ordering Code	Stok Stock		Takım Ölçüleri (mm) Dimension (mm)				Kesici Uç Insert	Yedek Parçaları Spare Parts			
	R	L	h	b	L	f		Sıkma Vidası Screw	Altık Shim	Altık Vidası Shim Screw	Tork Anahtar Torx Key
STJCR/L 0808 E09	●	●	08	08	70	10	TC.T 0902..	3007-M2.2x5	-	-	80-T07
1010 E09	●	●	10	10	70	12					
1212 F11	●	●	12	12	80	16	TC.T 1102..	4008-M2.5x6	-	-	80-T08
1616 H11	●	●	16	16	100	20					
1616 H16	●	●	16	16	100	20	TC.T 16T3..	4015-M3.5x14	AATN-2-0001	AAV-06-M3.5x11	80-T15
2020 K16	●	●	20	20	125	25					
2525 M16	●	●	25	25	150	32					
3232 P16	●	●	32	32	170	40					

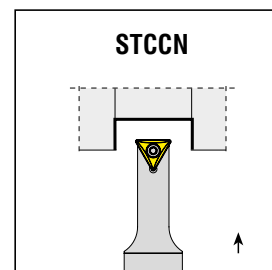
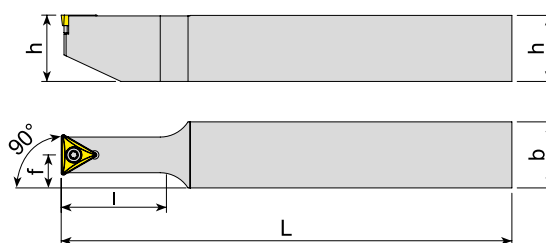

Takım Kodu Ordering Code	Stok Stock		Takım Ölçüleri (mm) Dimension (mm)					Kesici Uç Insert	Yedek Parçaları Spare Parts			
	R	L	h	b	L	f	l		Sıkma Vidası Screw	Altık Shim	Altık Vidası Shim Screw	Tork Anahtar Torx Key
STCCN 2020 L11	●		20	20	140	10	50	TC.T 1102..	4008-M2.5x6	-	-	80-T08
1616 K16	●		16	16	125	8	24					
2020 M16	●		20	20	150	10	30	TC.T 16T3..	4015-M3.5x14	AATN-2-0001	AAV-06-M3.5x11	80-T15
2525 P16	●		25	25	170	12.5	37.5					
3232 R16	●		32	32	200	16	48					
2525 P22	●		25	25	170	12.5	80					
								TC.T 2204..	4020-M4.5x12	-	-	80-T20

R: Sağ/Right L: Sol/Left ● Stokta/In Stock ○ Stokta Yok/Non Stock Item

Sipariş Örneği/Ordering Example : 1 ad./pcs. STJCR 0808 E09

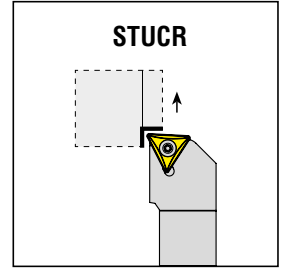
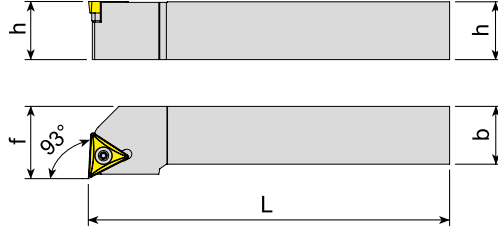

Takım Kodu Ordering Code	Stok Stock		Takım Ölçüleri (mm) Dimension (mm)				Kesici Uç Insert	Yedek Parçaları Spare Parts			
	R	L	h	b	L	f		Sıkma Vidası Screw	Altık Shim	Altık Vidası Shim Screw	Tork Anahtar Torx Key
	STUCR/L 0808 E09	●	●	08	08	70		10			
1010 E09	●	●	10	10	70	12					
1212 F11	●	●	12	12	80	16					
1616 H11	●	●	16	16	100	20	TC.T 1102..	4008-M2.5x6	-	-	80-T08
1616 H16	○	○	16	16	100	20					
2020 K16	●	●	20	20	125	25	TC.T 16T3..	4015-M3.5x14	AATN-2-0001	AAV-06-M3.5x11	80-T15
2525 M16	●	●	25	25	150	32					
3232 P16	●	●	32	32	170	40					

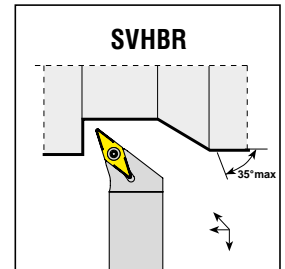
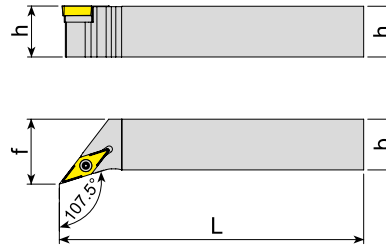

Takım Kodu Ordering Code	Stok Stock		Takım Ölçüleri (mm) Dimension (mm)				Kesici Uç Insert	Yedek Parçaları Spare Parts			
	R	L	h	b	L	f		Sıkma Vidası Screw	Altık Shim	Altık Vidası Shim Screw	Tork Anahtar Torx Key
	SVHBR/L 1212 F11	●	●	12	12	80		16			
1616 H11	●	●	16	16	100	20					
2020 K11	●	●	20	20	125	25					
2020 K16	●	●	20	20	125	25	VBM. 1604..	4015-M3.5x14	AAVN-2-0002	AAV-06-M3.5x11	80-T15
2525 M16	●	●	25	25	150	32					
3232 P16	●	●	32	32	170	40					

R: Sağ/Right L: Sol/Left ● Stokta/In Stock ○ Stokta Yok/Non Stock Item

Sipariş Örneği/Ordering Example : 1 ad./pcs. STUCR 0808 E09

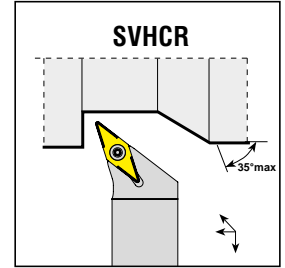
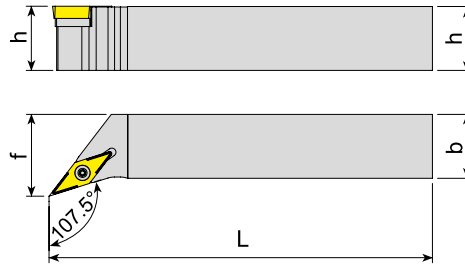

Takım Kodu Ordering Code	Stok Stock		Takım Ölçüleri (mm) Dimension (mm)				Kesici Uç Insert	Yedek Parçaları Spare Parts			
	R	L	h	b	L	f		Sıkma Vidası Screw	Altık Shim	Altık Vidası Shim Screw	Tork Anahtar Torx Key
SVHCR/L 1212 F11	●	●	12	12	80	16					
1616 H11	●	●	16	16	100	20					
2020 K11	●	●	20	20	125	25					
2020 K16	●	●	20	20	125	25					
2525 M16	●	●	25	25	150	32					
3232 P16	●	●	32	32	170	40					

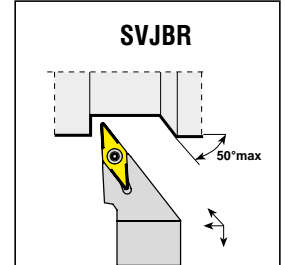
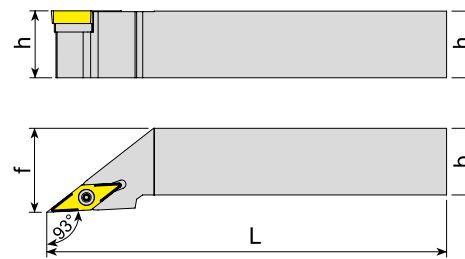

Takım Kodu Ordering Code	Stok Stock		Takım Ölçüleri (mm) Dimension (mm)				Kesici Uç Insert	Yedek Parçaları Spare Parts			
	R	L	h	b	L	f		Sıkma Vidası Screw	Altık Shim	Altık Vidası Shim Screw	Tork Anahtar Torx Key
SVJBR/L 1212 F11	●	●	12	12	80	16					
1616 H11	●	●	16	16	100	20					
2020 K11	●	●	20	20	125	25					
1616 H16	●	●	16	16	100	20					
2020 K16	●	●	20	20	125	25					
2525 M16	●	●	25	25	150	32					
3232 P16	●	●	32	32	170	40					

R: Sağ/Right L: Sol/Left ● Stokta/In Stock ○ Stokta Yok/Non Stock Item

Sipariş Örneği/Ordering Example : 1 ad./pcs. SVHCR 1212 F11

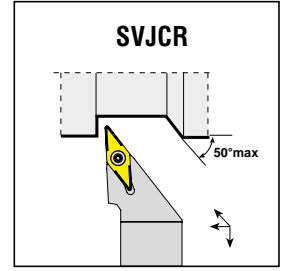
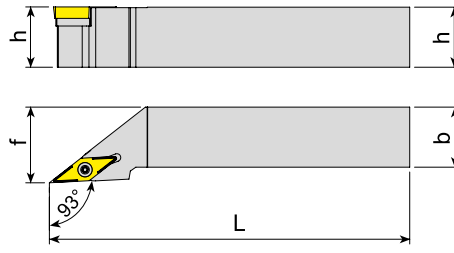

Takım Kodu Ordering Code	Stok Stock		Takım Ölçüleri (mm) Dimension (mm)				Kesici Uç Insert	Yedek Parçaları Spare Parts			
	R	L	h	b	L	f		Sıkma Vidası Screw	Altık Shim	Altık Vidası Shim Screw	Tork Anahtar Torx Key
SVJCR/L 1212 F11	●	●	12	12	80	16	VC.T 1103..	4008-M2.5x6	-	-	80-T08
1616 H11	●	●	16	16	100	20					
2020 K11	●	●	20	20	125	25					
1212 F16	●	○	12	12	80	16	VC.T 1604..	4015-M3.5x14	AAVN-2-0002	AAV-06-M3.5x11	80-T15
2020 K16	●	●	20	20	125	25					
2525 M16	●	●	25	25	150	32					
3232 P16	●	●	32	32	170	40					

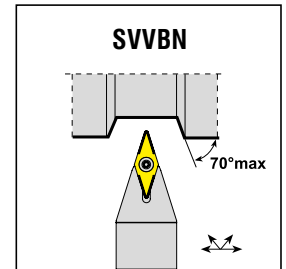
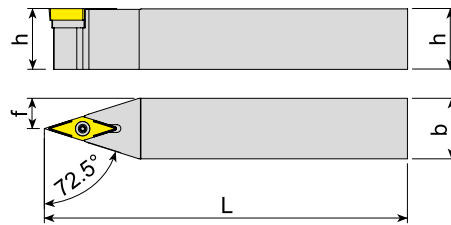

Takım Kodu Ordering Code	Stok Stock		Takım Ölçüleri (mm) Dimension (mm)				Kesici Uç Insert	Yedek Parçaları Spare Parts			
	R	L	h	b	L	f		Sıkma Vidası Screw	Altık Shim	Altık Vidası Shim Screw	Tork Anahtar Torx Key
SVVBN 1212 F11	●		12	12	80	06	VBM. 1103..	4008-M2.5x6	-	-	80-T08
1616 H11	●		16	16	100	08					
2020 K11	●		20	20	125	10					
2020 K16	●		20	20	125	10	VBM. 1604..	4015-M3.5x14	AAVN-2-0002	AAV-06-M3.5x11	80-T15
2525 M16	●		25	25	150	12.5					
3232 P16	●		32	32	170	16					

R: Sağ/Right L: Sol/Left ● Stokta/In Stock ○ Stokta Yok/Non Stock Item

Sipariş Örneği/Ordering Example : 1 ad./pcs. SVJCR 1212 F11

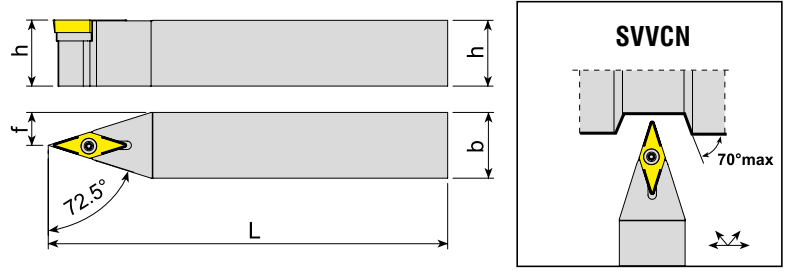

Takım Kodu Ordering Code	Stok Stock	Takım Ölçüleri (mm) Dimension (mm)				Kesici Uç Insert	Yedek Parçaları Spare Parts			
		h	b	L	f		Sıkma Vidası Screw	Altılık Shim	Altılık Vidası Shim Screw	Tork Anahtar Torx Key
SVVCN 1212 F11	●	12	12	80	06	VC.T 1103..	4008-M2.5x6	-	-	80-T08
1616 H11	●	16	16	100	08					
2020 K11	●	20	20	125	10					
2020 K16	●	20	20	125	10					
2525 M16	●	25	25	150	12.5	VC.T 1604..	4015-M3.5x14	AAVN-2-0002	AAV-06-M3.5x11	80-T15
3232 P16	●	32	32	170	16					

S-SİSTEM İSVİÇRE TİPİ KAYAR OTOMAT MAKİNA TAKIMLARI
S-SYSTEM TOOLS FOR SWISS TYPE SLIDING AUTOMATIC LATHES

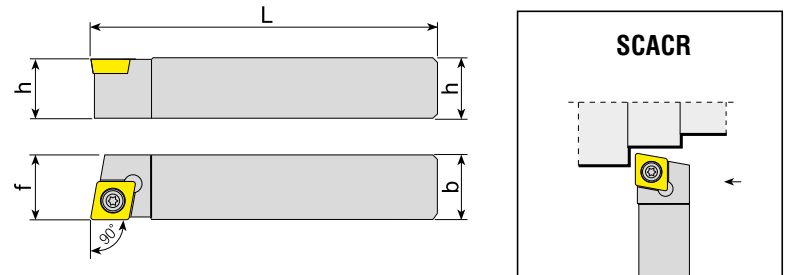

Takım Kodu Ordering Code	Stok Stock		Takım Ölçüleri (mm) Dimension (mm)				Kesici Uç Insert	Yedek Parçaları Spare Parts			
	R	L	h	b	L	f		Sıkma Vidası Screw	Altılık Shim	Altılık Vidası Shim Screw	Tork Anahtar Torx Key
SCACR/L 0808 X06-S	●	●	08	08	115	08	CCM. 0602..	4008-M2.5x6	-	-	80-T08
1010 K06-S	●	○	10	10	125	10					
1212 G06-S	●	○	12	12	90	12					
1212 K06-S	●	○	12	12	125	12					
1616 F06-S	○	○	16	16	75	16					
1616 K06-S	○	○	16	16	125	16					
1212 G09-S	○	○	12	12	90	12	CCM. 09T3..	4015-M3.5x11	-	-	80-T15
1212 K09-S	●	●	12	12	125	12					
1616 F09-S	○	○	16	16	75	16					
1616 K09-S	●	●	16	16	125	16					
2020 K09-S	●	●	20	20	125	20					

R: Sağ/Right L: Sol/Left ● Stokta/In Stock ○ Stokta Yok/Non Stock Item

Sipariş Örneği/Ordering Example : 1 ad./pcs. SVVCN 1212 F11

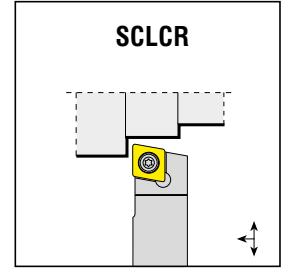
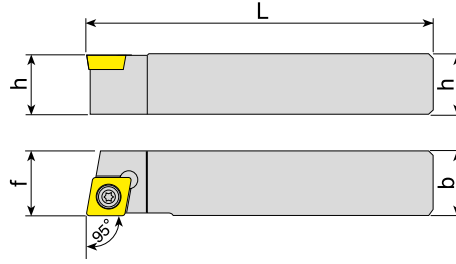

Takım Kodu Ordering Code	Stok Stock		Takım Ölçüleri (mm) Dimension (mm)				Kesici Uç Insert	Yedek Parçaları Spare Parts			
	R	L	h	b	L	f		Sıkma Vidası Screw	Altık Shim	Altık Vidası Shim Screw	Tork Anahtar Torx Key
	SCLCR/L 0808 X06-S	●	●	08	08	115		08	CCM. 0602..	4008-M2.5x6	-
1010 X06-S	●	○	10	10	115	10					
1212 G06-S	●	○	12	12	90	12					
1212 X06-S	●	○	12	12	130	12					
1616 F06-S	●	○	16	16	75	16					
1616 X06-S	●	○	16	16	130	16					
1212 G09-S	●	○	12	12	90	12	CCM. 09T3..	4015-M3.5x11	-	-	80-T15
1212 X09-S	●	○	12	12	130	12					
1616 F09-S	●	○	16	16	75	16					
1616 G09-S	●	○	16	16	90	16					
1616 X09-S	●	○	16	16	130	16					
2020 X09-S	●	○	20	20	120	20					

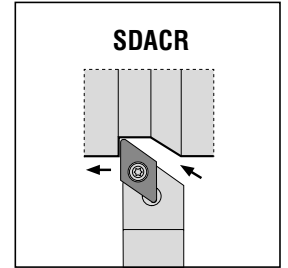
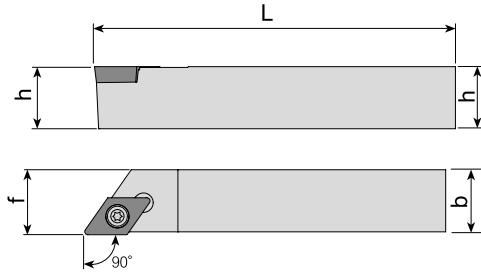

Takım Kodu Ordering Code	Stok Stock		Takım Ölçüleri (mm) Dimension (mm)				Kesici Uç Insert	Yedek Parçaları Spare Parts			
	R	L	h	b	L	f		Sıkma Vidası Screw	Altık Shim	Altık Vidası Shim Screw	Tork Anahtar Torx Key
	SDACR/L 0808 X07-S	●	●	08	08	115		08	DC.T 0702..	4008-M2.5x6	-
1010 K07-S	●	●	10	10	125	10					
1212 G07-S	○	○	12	12	90	12					
1212 K07-S	●	●	12	12	125	12					
1616 F07-S	○	○	16	16	75	16					
1616 K07-S	●	●	16	16	125	16					
1212 G11-S	○	○	12	12	90	12	DC.T 11T3..	4015-M3.5x11	-	-	80-T15
1212 K11-S	●	●	12	12	125	12					
1616 F11-S	●	○	16	16	75	16					
1616 K11-S	●	●	16	16	125	16					
2020 K11-S	●	●	20	20	125	20					

R: Sağ/Right L: Sol/Left ● Stokta/In Stock ○ Stokta Yok/Non Stock Item

Sipariş Örneği/Ordering Example : 1 ad./pcs. SCLCR 0808 X06-S



www.akkocom.tr

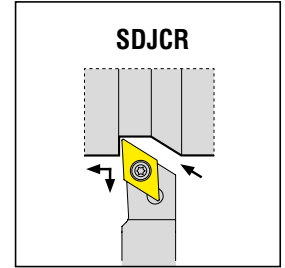
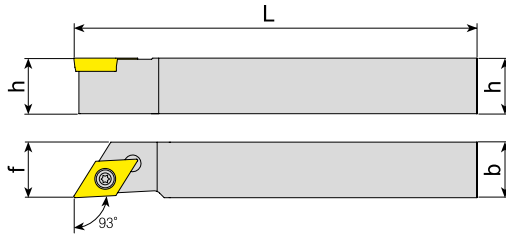

Takım Kodu Ordering Code	Stok Stock		Takım Ölçüleri (mm) Dimension (mm)				Kesici Uç Insert	Yedek Parçaları Spare Parts			
	R	L	h	b	L	f		Sıkma Vidası Screw	Altık Shim	Altık Vidası Shim Screw	Tork Anahtar Torx Key
SDJCR/L 0808 X07-S	●	○	08	08	115	08	DC.T 0702..				80-T08
1010 X07-S	●	●	10	10	115	10					
1212 G07-S	●	○	12	12	90	12					
1212 X07-S	●	○	12	12	130	12					
1616 F07-S	●	○	16	16	75	16					
1616 X07-S	●	○	16	16	130	16					
2020 X07-S	●	○	20	20	120	20					
1212 G11-S	●	○	12	12	90	12	DC.T 11T3..				80-T15
1212 X11-S	●	●	12	12	130	12					
1212 K11-S	●	●	12	12	125	12					
1616 F11-S	●	○	16	16	75	16					
1616 X11-S	●	○	16	16	130	16					
1616 K11-S	●	●	16	16	125	16					
2020 X11-S	●	○	20	20	120	20					

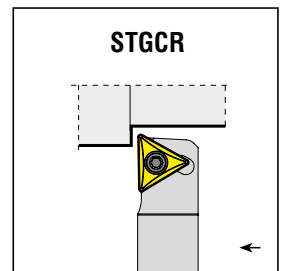
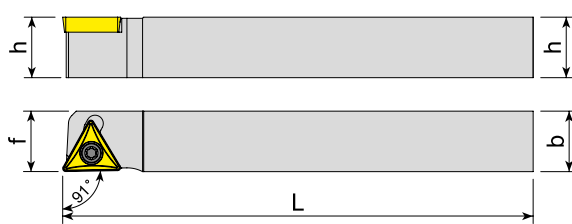



Takım Kodu Ordering Code	Stok Stock		Takım Ölçüleri (mm) Dimension (mm)				Kesici Uç Insert	Yedek Parçaları Spare Parts			
	R	L	h	b	L	f		Sıkma Vidası Screw	Altık Shim	Altık Vidası Shim Screw	Tork Anahtar Torx Key
STGCR/L 1216 K11-S	●	○	12	16	125	16	TC.T 1102..				80-T08
1616 K11-S	●	○	16	16	125	16					
1216 K16-S	●	○	12	16	125	16	TC.T 16T3..				80-T15
1616 K16-S	●	○	16	16	125	16					



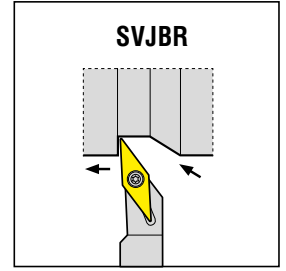
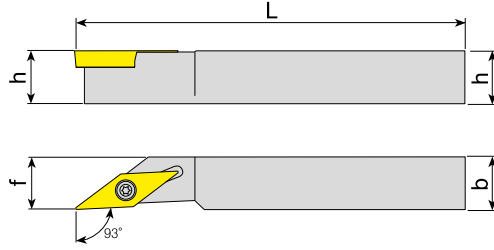

R: Sağ/Right L: Sol/Left ● Stokta/In Stock ○ Stokta Yok/Non Stock Item

Sipariş Örneği/Ordering Example : 1 ad./pcs. SDJCR 1212 K11-S

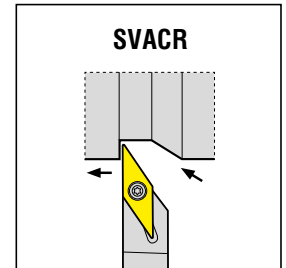
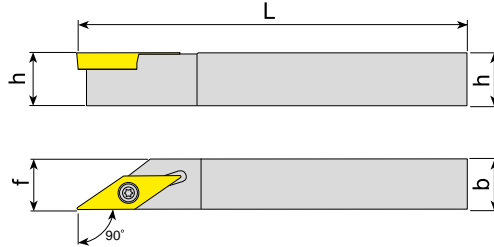

Takım Kodu Ordering Code	Stok Stock		Takım Ölçüleri (mm) Dimension (mm)				Kesici Uç Insert	Yedek Parçaları Spare Parts			
	R	L	h	b	L	f		Sıkma Vidası Screw	Altık Shim	Altık Vidası Shim Screw	Tork Anahtar Torx Key
SVJBR/L 1616 K11-S	●	●	16	16	125	16			-	-	

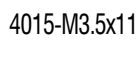
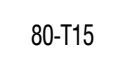

Takım Kodu Ordering Code	Stok Stock		Takım Ölçüleri (mm) Dimension (mm)				Kesici Uç Insert	Yedek Parçaları Spare Parts			
	R	L	h	b	L	f		Sıkma Vidası Screw	Altık Shim	Altık Vidası Shim Screw	Tork Anahtar Torx Key
SVACR/L 0808 X11-S	○	○	08	08	115	08			-	-	
1010 K11-S	●	○	10	10	125	10					
1212 G11-S	○	○	12	12	90	12					
1212 K11-S	●	●	12	12	125	12					
1616 F11-S	○	○	16	16	75	16					
1616 K11-S	●	●	16	16	125	16					
2020 K11-S	●	●	20	20	125	20					
1212 K16-S	●	●	12	12	125	12			-	-	
1616 K16-S	●	●	16	16	125	16					

R: Sağ/Right L: Sol/Left ● Stokta/In Stock ○ Stokta Yok/Non Stock Item

Sipariş Örneği/Ordering Example : 1 ad./pcs. SVJBR 1616 K11-S

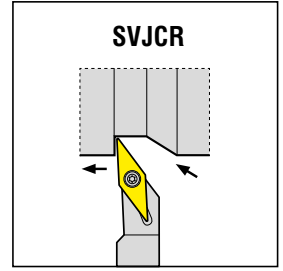
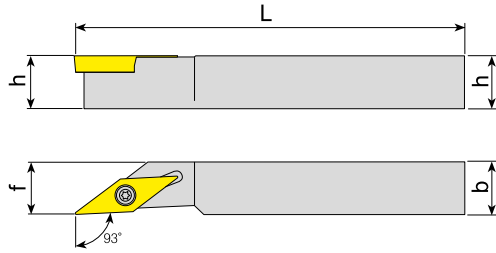

Takım Kodu Ordering Code	Stok Stock		Takım Ölçüleri (mm) Dimension (mm)				Kesici Uç Insert	Yedek Parçaları Spare Parts			
	R	L	h	b	L	f		Sıkma Vidası Screw	Aıtlık Shim	Aıtlık Vidası Shim Screw	Tork Anahtar Torx Key
SVJCR/L 0808 X11-S	●	○	08	08	115	08	VC.T 1103..	4008-M2.5x6	-	-	80-T08
1010 K11-S	○	○	10	10	125	10					
1212 G11-S	○	○	12	12	90	12					
1212 K11-S	●	●	12	12	125	12					
1616 F11-S	○	○	16	16	75	16					
1616 K11-S	○	○	16	16	125	16					
2020 K11-S	○	○	20	20	125	20					

R: Sağ/Right L: Sol/Left ● Stokta/In Stock ○ Stokta Yok/Non Stock Item

Sipariş Örneği/Ordering Example : 1 ad./pcs. SVJCR 0808 X11-S



DELİK TORNA TAKIMLARI
INTERNAL TURNING TOOLHOLDERS





1 Takım Malzemesi / Type of Boring Bar

"A" Yekpare çelik gövde soğutma suyu kanallı / "A" Solid steel with coolant hole
 "E" Çelik başlıkla sert metal gövde ve soğutma suyu kanallı /
 "E" Carbide bar with fixed steel head and coolant hole
 "C" Karbür Şaft / "C" Carbide shank
 "S" Çelik Şaft / "S" Steel shank

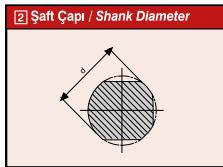

3 Şaft Boyu / Shank Length

A - 32	H - 100	Q - 180	x-special
B - 40	J - 110	R - 200	
C - 50	K - 125	S - 250	
D - 60	L - 140	T - 300	
E - 70	M - 150	U - 350	
F - 80	N - 160	V - 400	
G - 90	P - 170	W - 450	

(mm)

4 Sıkma Tipi / Method of Mounting of Insert

C Deliksiz Üstten Sıkma / Top clamping without hole
 T Üstten Delikle Sıkma / Top and Hole Clamping
 M Üstten ve Delikten Sıkma / Top and Hole Clamping
 P Delikten Laye ile Sıkma / Hole Clamping (Lever Lock)
 S Vida ile Sıkma / Screw on

5 Uç Tipi / Insert Shape

C 80°
 D 55°
 E 75°
 V 35°
 R
 S
 W 80°
 K 55°
 T

6 Yanaşma Açısı / Tool Holder Shape Bar Geometry

L 95°
 F 90°
 S 45°
 X 93°
 J 93°
 U 93°
 K 75°
 Q 107.5°
 P 117.5°
 (-)

7 Serbest Uç Açısı / Insert Clearance Angle

B 5°
 C 7°
 N 0°
 P 11°

8 Kesme Yönü / Cutting Direction

R
 L

9 Kesme Kenar Uzunluğu / Cutting Edge Length

T
 S
 C
 D
 l

10 Baskı Pabucu / Wedge Clamp



T&C-SİSTEM

T&C SİSTEM DELİK TORNA KATERLERİ
T&C SYSTEM BORING BARS

konusulan
the spoken kalite...
quality...



www.akkо.com.tr

Дистрибьютер ООО "Ресурс Плюс"
+7 (351) 247-74-40; info@rp-ural.ru

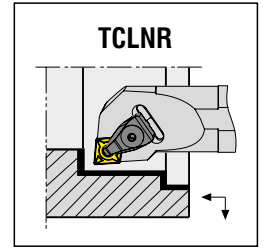
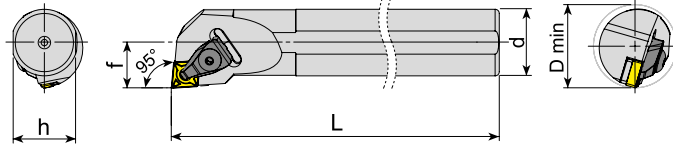

Takım Kodu Ordering Code	Stok Stock		Takım Ölçüleri (mm) Dimension (mm)				Kesici Uç Insert	Yedek Parçaları Spare Parts							
	R	L	d	h	L	f		D min	Baskı Pabucu Wedge Clamp	Pabuç Vidası Clamp Screw	Altık Shim	Altık Vidası Shim Screw	Yay Spring	Pul Stamp	Anahtar Allen Key
S25S TCLNR/L 09	●	●	25	23	250	17	≥32	CNM. 0903..	ATK-01	AKV-01-M5x22	AACN-2-0001	AAV-09-M5x9	-		
S25S TCLNR/L 12	●	●	25	23	250	17	≥32					AAV-13-M5x8			
S32T TCLNR/L 12	●	●	32	30	300	22	≥40	CNM. 1204..	ATK-02	AKV-02-M6x22	AACN-3-0001	AAV-02-M5x12	AKY-01	ABPL-01	AAL-03-3
S40U TCLNR/L 12	●	●	40	37.5	350	27	≥50								
S50V TCLNR/L 12	●	●	50	47	400	35	≥63								
S32T TCLNR/L 16	●	●	32	30	300	22	≥40	CNM. 1606..	ATK-04	AKV-19-M7x25	AACN-3-0002	AAV-05-M6x15	-	ABPL-02	AAL-05-4
S40U TCLNR/L 16	●	●	40	37.5	350	27	≥50								
S50V TCLNR/L 16	●	●	50	47	400	35	≥63								

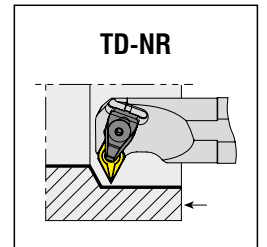
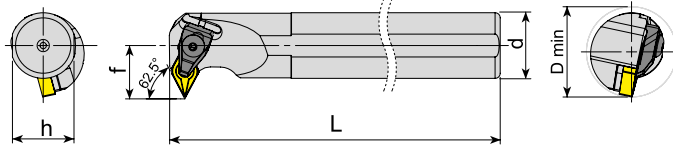

Takım Kodu Ordering Code	Stok Stock		Takım Ölçüleri (mm) Dimension (mm)				Kesici Uç Insert	Yedek Parçaları Spare Parts							
	R	L	d	h	L	f		D min	Baskı Pabucu Wedge Clamp	Pabuç Vidası Clamp Screw	Altık Shim	Altık Vidası Shim Screw	Yay Spring	Pul Stamp	Anahtar Allen Key
S32T TD-NR/L 15	●	●	32	30	300	26	≥44	DNM. 1506..	ATK-02	AKV-02-M6x22	AADN-3-0001	AAV-02-M5x12	AKY-01	ABPL-01	AAL-03-3
S40U TD-NR/L 15	●	●	40	37.5	350	29	≥52								
S50V TD-NR/L 15	●	●	50	47	400	35	≥63								

R: Sağ/Right L: Sol/Left ● Stokta/In Stock ○ Stokta Yok/Non Stock Item

Sipariş Örneği/Ordering Example : 1 ad./pcs. S25S TCLNR 09

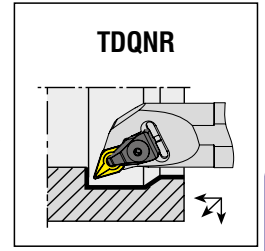
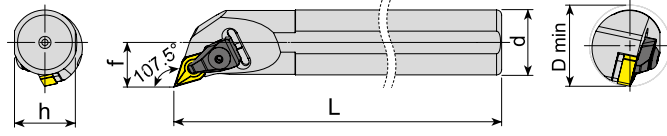

Takım Kodu Ordering Code	Stok Stock		Takım Ölçüleri (mm) Dimension (mm)				Kesici Uç Insert	Yedek Parçaları Spare Parts							
	R	L	d	h	L	f		D min	Baskı Pabucu Wedge Clamp	Pabuç Vidası Clamp Screw	Altlık Shim	Altlık Vidası Shim Screw	Yay Spring	Pul Stamp	Anahtar Allen Key
S25S TDQNR/L 11	●	●	25	23	250	17	≥32	DNM. 1104..	ATK-01	AKV-01-M5x22	AADN-2-0001	AAV-09-M5x9	-	ABPL-01	AAL-03-3
S32T TDQNR/L 11	●	●	32	30	300	22	≥40					AAV-04-M5x12			
S25S TDQNR/L 15	●	○	25	23	250	17	≥32	DNM. 1506..	ATK-02	AKV-02-M6x22	AADN-3-0001	AAV-13-M5x8	AKY-01	ABPL-01	AAL-03-3
S32T TDQNR/L 15	●	●	32	30	300	22	≥40					AAV-02-M5x12			
S40U TDQNR/L 15	●	●	40	37.5	350	27	≥50								
S50V TDQNR/L 15	●	●	50	47	400	35	≥63								

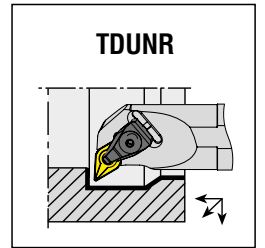
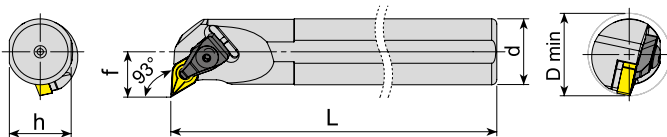

Takım Kodu Ordering Code	Stok Stock		Takım Ölçüleri (mm) Dimension (mm)				Kesici Uç Insert	Yedek Parçaları Spare Parts							
	R	L	d	h	L	f		D min	Baskı Pabucu Wedge Clamp	Pabuç Vidası Clamp Screw	Altlık Shim	Altlık Vidası Shim Screw	Yay Spring	Pul Stamp	Anahtar Allen Key
S25S TDUNR/L 11	●	●	25	23	250	17	≥32	DNM. 1104..	ATK-01	AKV-01-M5x22	AADN-2-0001	AAV-09-M5x9	-	ABPL-01	AAL-03-3
S32T TDUNR/L 11	●	●	32	30	300	22	≥40					AAV-04-M5x12			
S25S TDUNR/L 15	●	●	25	23	250	17	≥34	DNM. 1506..	ATK-02	AKV-02-M6x22	AADN-3-0001	AAV-13-M5x8	AKY-01	ABPL-01	AAL-03-3
S32T TDUNR/L 15	●	●	32	30	300	22	≥40					AAV-02-M5x12			
S40U TDUNR/L 15	●	●	40	37.5	350	27	≥50								
S50V TDUNR/L 15	●	●	50	47	400	35	≥63								

R: Sağ/Right L: Sol/Left ●Stokta/In Stock ○Stokta Yok/Non Stock Item

Sipariş Örneği/Ordering Example : 1 ad./pcs. S25S TDQNR 11

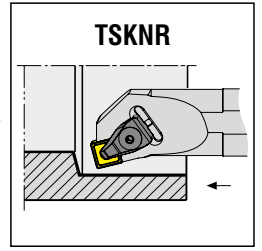
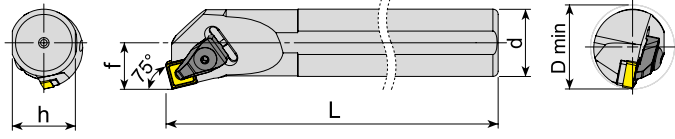

Takım Kodu Ordering Code	Stok Stock		Takım Ölçüleri (mm) Dimension (mm)				Kesici Uç Insert	Yedek Parçaları Spare Parts							
	R	L	d	h	L	f		D min	Baskı Pabucu Wedge Clamp	Pabuç Vidası Clamp Screw	Altılık Shim	Altılık Vidası Shim Screw	Yay Spring	Pul Stamp	Anahtar Allen Key
S25S TSKNR/L 12	●	●	25	23	250	17	≥32	SNM. 1204..	ATK-02	AKV-02-M6x22	AASN-3-0004	AAV-13-M5x8	AKY-01	ABPL-01	AAL-03-3
S32T TSKNR/L 12	●	●	32	30	300	22	≥40					AAV-02-M5x12			
S40U TSKNR/L 12	●	●	40	37.5	350	27	≥50								

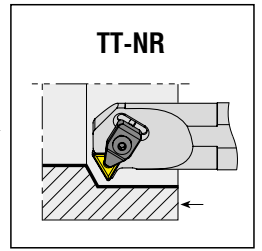
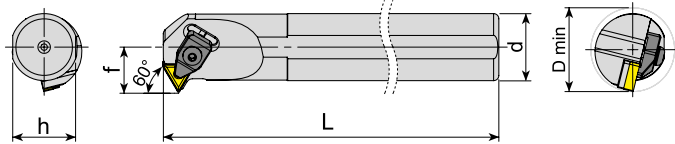

Takım Kodu Ordering Code	Stok Stock		Takım Ölçüleri (mm) Dimension (mm)				Kesici Uç Insert	Yedek Parçaları Spare Parts							
	R	L	d	h	L	f		D min	Baskı Pabucu Wedge Clamp	Pabuç Vidası Clamp Screw	Altılık Shim	Altılık Vidası Shim Screw	Yay Spring	Pul Stamp	Anahtar Allen Key
S25S TT-NR/L 16	●	●	25	23	250	17	≥32	TNM. 1604..	ATK-01	AKV-01-M5x22	AATN-2-0002	AAV-03-M5x12	-	ABPL-01	AAL-03-3
S32T TT-NR/L 16	●	●	32	30	300	22	≥40					AAV-03-M5x12			

R: Sağ/Right L: Sol/Left ● Stokta/In Stock ○ Stokta Yok/Non Stock Item

Sipariş Örneği/Ordering Example : 1 ad./pcs. S25S TSKNR 12

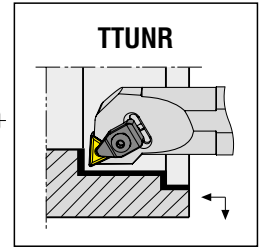
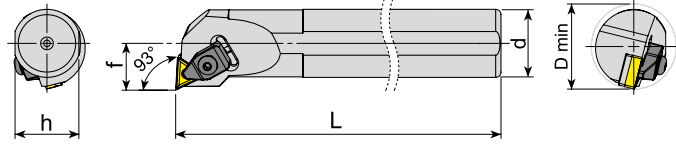

Takım Kodu Ordering Code	Stok Stock		Takım Ölçüleri (mm) Dimension (mm)				Kesici Uç Insert	Yedek Parçaları Spare Parts							
	R	L	d	h	L	f		D min	Baskı Pabucu Wedge Clamp	Pabuç Vidası Clamp Screw	Altlık Shim	Altlık Vidası Shim Screw	Yay Spring	Pul Stamp	Anahtar Allen Key
S25S TTUNR/L 16	●	●	25	23	250	17	≥32	TNM. 1604..	ATK-01	AKV-01-M5x22	AATN-2-0002	AAV-03-M5x12	-	ABPL-01	AAL-03-3
S32T TTUNR/L 16	●	●	32	30	300	22	≥40								
S25S TTUNR/L 22	●	●	25	23	250	17	≥32	TNM. 2204..	ATK-02	AKV-02-M6x22	AATN-3-0015	AAV-02-M5x12	AKY-01	ABPL-01	AAL-03-3
S32T TTUNR/L 22	●	●	32	30	300	22	≥40								
S40U TTUNR/L 22	●	●	40	37.5	350	27	≥50								
S50V TTUNR/L 22	●	●	50	47	400	35	≥63								

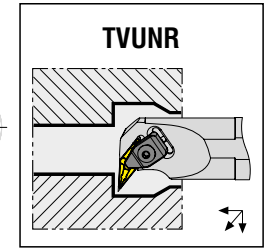
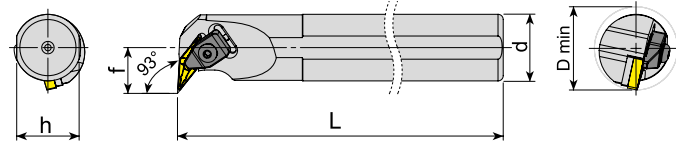

Takım Kodu Ordering Code	Stok Stock		Takım Ölçüleri (mm) Dimension (mm)				Kesici Uç Insert	Yedek Parçaları Spare Parts							
	R	L	d	h	L	f		D min	Baskı Pabucu Wedge Clamp	Pabuç Vidası Clamp Screw	Altlık Shim	Altlık Vidası Shim Screw	Yay Spring	Pul Stamp	Anahtar Allen Key
S25S TVUNR/L 16	●	●	25	23	250	20	≥36	VNM. 1604..	ATK-01	AKV-01-M5x22	AAVN-2-0002	AAV-04-M5x12	-	ABPL-01	AAL-03-3
S32T TVUNR/L 16	●	●	32	30	300	22	≥40								
S40U TVUNR/L 16	●	●	40	37.5	350	27	≥50								

R: Sağ/Right L: Sol/Left ● Stokta/In Stock ○ Stokta Yok/Non Stock Item

Sipariş Örneği/Ordering Example : 1 ad./pcs. S25S TTUNR 16

➤ T-SİSTEM DELİK TORNA KATERLERİ
T-SYSTEM BORING BARS

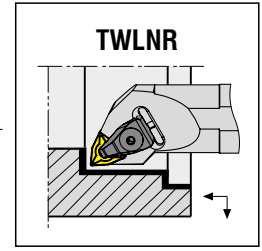
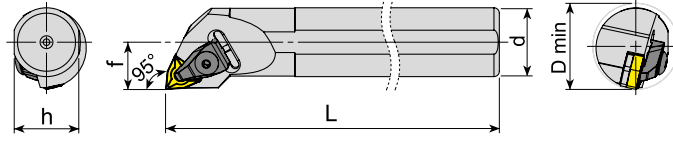

Takım Kodu Ordering Code	Stok Stock		Takım Ölçüleri (mm) Dimension (mm)				Kesici Uç Insert	Yedek Parçaları Spare Parts							
	R	L	d	h	L	f		D min	Baskı Pabucu Wedge Clamp	Pabuç Vidası Clamp Screw	Altılık Shim	Altılık Vidası Shim Screw	Yay Spring	Pul Stamp	Anahtar Allen Key
S25S TWLNR/L 06	●	●	25	23	250	17	≥32	WNM. 0604..	ATK-01	AKV-01-M5x22	AAWN-SW317	AAV-01-M3x10	-	ABPL-01	AAL-03-3
S32T TWLNR/L 06	●	●	32	30	300	22	≥40					AAV-13-M5x8			
S25S TWLNR/L 08	●	●	25	23	250	17	≥32	WNM. 0804..	ATK-02	AKV-02-M6x22	AAWN-3-0001	AAV-02-M5x12	AKY-01	ABPL-01	AAL-03-3
S32T TWLNR/L 08	●	●	32	30	300	22	≥40								
S40U TWLNR/L 08	●	●	40	37.5	350	27	≥50								
S50V TWLNR/L 08	●	●	50	47	400	35	≥63								

➤ C-SİSTEM DELİK TORNA KATERLERİ
C-SYSTEM BORING BARS

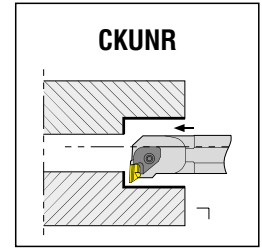
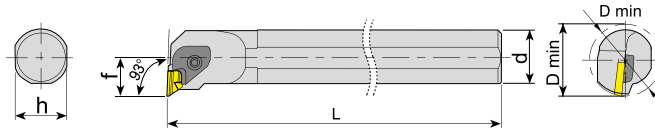

Takım Kodu Ordering Code	Stok Stock		Takım Ölçüleri (mm) Dimension (mm)				Kesici Uç Insert	Yedek Parçaları Spare Parts							
	R	L	d	h	L	f		D min	Baskı Pabucu Wedge Clamp	Pabuç Vidası Clamp Screw	Altılık Shim	Altılık Vidası Shim Screw	Yay Spring	Pul Stamp	Anahtar Allen Key
S25S CKUNR/L 16	●	●	25	23	250	19	≥38	KNUX 1604..	ACK-01-R ACK-02-L	AKV-06-M6x20	AKS-16-R AKS-16-L	AAV-01-M3x10	AKY-02	ABPL-01	AAL-05-4
S32T CKUNR/L 16	●	●	32	30	300	22	≥40								
S40U CKUNR/L 16	●	●	40	37.5	350	27	≥50								
S50V CKUNR/L 16	●	●	50	47	400	35	≥63								

R: Sağ/Right L: Sol/Left ● Stokta/In Stock ○ Stokta Yok/Non Stock Item

Sipariş Örneği/Ordering Example : 1 ad./pcs. S25S TWLNR 06

M-SİSTEM

M-SİSTEM DELİK TORNA KATERLERİ
M-SYSTEM BORING BARS

*konusulan
the spoken kalite...
quality...*



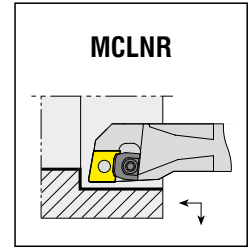
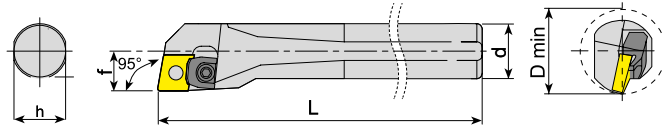

Takım Kodu Ordering Code	Stok Stock		Takım Ölçüleri (mm) Dimension (mm)					Kesici Uç Insert	Yedek Parçaları Spare Parts						
	R	L	d	h	L	f	D min		Baskı Pabucu Wedge Clamp	Pabuç Vidası Clamp Screw	Altlık Shim	Pim Pin	Pul Stamp	Anahtar Allen Key	
S20R MCLNR/L 12	●	●	20	18.3	200	13	≥25	CNM. 1204..	AMK-07	AKV-04-M5x17	-	APM-12	-	AAL-03-3	
S25S MCLNR/L 12	●	●	25	23	250	17	≥32		AMK-03		AACN-3-0001	APM-13			
S32T MCLNR/L 12	●	●	32	30	300	22	≥40					APM-04			

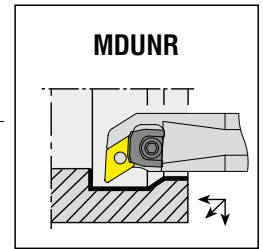
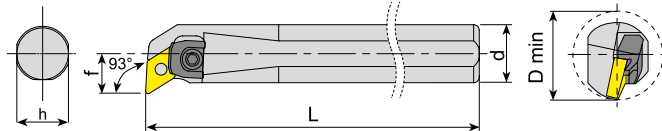

Takım Kodu Ordering Code	Stok Stock		Takım Ölçüleri (mm) Dimension (mm)					Kesici Uç Insert	Yedek Parçaları Spare Parts						
	R	L	d	h	L	f	D min		Baskı Pabucu Wedge Clamp	Pabuç Vidası Clamp Screw	Altlık Shim	Pim Pin	Pul Stamp	Anahtar Allen Key	
S20R MDUNR/L 11	●	●	20	18.3	200	13	≥25	DNM. 1104..	AMK-03	AKV-17-M5x15	-	APM-03	-	AAL-03-3	
S25S MDUNR/L 11	●	●	25	23	250	17	≥32			AKV-04-M5x17					
S32T MDUNR/L 11	○	○	32	30	300	22	≥40								
S25S MDUNR/L 15	●	●	25	23	250	17	≥32	DNM. 1506..	AMK-04	AKV-20-M6x19	AADN-3-0001	APM-04	ABPL-01	AAL-03-3	
S32T MDUNR/L 15	●	●	32	30	300	22	≥40			AKV-02-M6x22					
S40U MDUNR/L 15	●	●	40	37.5	350	27	≥50								
S50V MDUNR/L 15	●	●	50	47	400	35	≥63								

R: Sağ/Right L: Sol/Left ● Stokta/In Stock ○ Stokta Yok/Non Stock Item

Sipariş Örneği/Ordering Example : 1 ad./pcs. S20R MCLNR 12

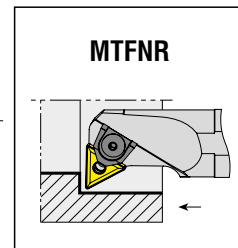
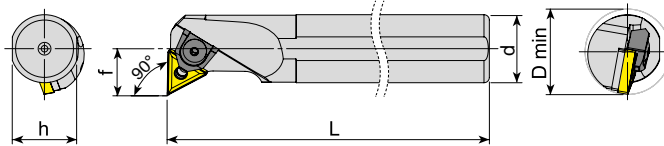

Takım Kodu Ordering Code	Stok Stock		Takım Ölçüleri (mm) Dimension (mm)					Kesici Uç Insert	Yedek Parçaları Spare Parts							
	R	L	d	h	L	f	D min		Baskı Pabucu Wedge Clamp	Pabuç Vidası Clamp Screw	Altlık Shim	Pim Pin	Pul Stamp	Anahtar Allen Key		
S20R MTFNR/L 16	●	●	20	18.3	200	14	≥25	TNM. 1604..	AMK-02	AKV-17-M5x15	-	APM-03	-	ABPL-01	AAL-03-3	
S25S MTFNR/L 16	●	●	25	23	250	17	≥32		AMK-04	AKV-02-M6x22	AATN-2-0002	APM-14				
S32T MTFNR/L 16	●	●	32	30	300	22	≥40									APM-01
S40U MTFNR/L 16	●	●	40	37.5	350	27	≥50									
S32T MTFNR/L 22	●	●	32	30	300	22	≥40	TNM. 2204..	AMK-04	AKV-02-M6x22	AATN-3-0015	APM-02				
S40U MTFNR/L 22	●	○	40	37.5	350	27	≥50									
S50V MTFNR/L 22	●	○	50	47	400	35	≥63									

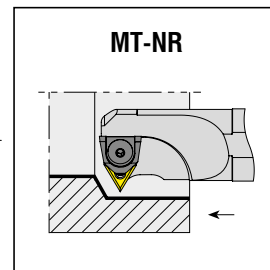
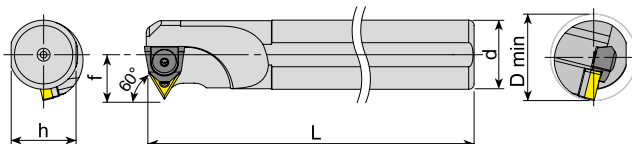

Takım Kodu Ordering Code	Stok Stock		Takım Ölçüleri (mm) Dimension (mm)					Kesici Uç Insert	Yedek Parçaları Spare Parts									
	R	L	d	h	L	f	D min		Baskı Pabucu Wedge Clamp	Pabuç Vidası Clamp Screw	Altlık Shim	Pim Pin	Pul Stamp	Anahtar Allen Key				
S20R MT-NR/L 16	●	●	20	18.3	200	16	≥26	TNM. 1604..	AMK-02	AKV-04-M5x17	AATN-2-0002	APM-03	-	ABPL-01	AAL-03-3			
S25S MT-NR/L 16	●	●	25	23	250	17	≥32										APM-14	
S32T MT-NR/L 16	●	●	32	30	300	22	≥40										APM-01	
S40U MT-NR/L 16	●	●	40	37.5	350	27	≥50											
S32T MT-NR/L 22	●	●	32	30	300	24	≥40	TNM. 2204..	AMK-04	AKV-02-M6x22	AATN-3-0015	APM-02						
S40U MT-NR/L 22	●	●	40	37.5	350	27	≥50											
S50U MT-NR/L 22	●	○	50	47	350	35	≥63											

R: Sağ/Right L: Sol/Left ● Stokta/In Stock ○ Stokta Yok/Non Stock Item

Sipariş Örneği/Ordering Example : 1 ad./pcs. S20R MTFNR 16

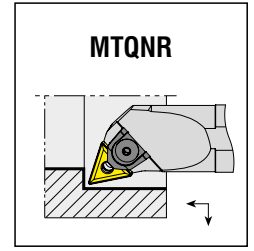
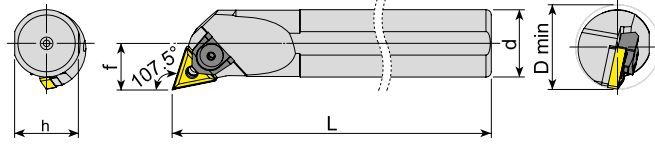

Takım Kodu Ordering Code	Stok Stock		Takım Ölçüleri (mm) Dimension (mm)					Kesici Uç Insert	Yedek Parçaları Spare Parts							
	R	L	d	h	L	f	D min		Baskı Pabucu Wedge Clamp	Pabuç Vidası Clamp Screw	Aitlik Shim	Pim Pin	Pul Stamp	Anahtar Allen Key		
S20R MTQNR/L 16	●	●	20	18.3	200	13	≥25	TNM. 1604..	AMK-02	AKV-17-M5x15	-	APM-11	-	ABPL-01	AAL-03-3	
S25S MTQNR/L 16	●	●	25	23	250	17	≥32		AMK-04	AKV-02-M6x22	AATN-2-0002	APM-14	-			
S32T MTQNR/L 16	●	●	32	30	300	22	≥40				AMK-04	AKV-02-M6x22				AATN-2-0002
S40U MTQNR/L 16	●	●	40	37.5	350	27	≥50		AMK-04	AKV-02-M6x22			AATN-3-0015			APM-02
S32T MTQNR/L 22	●	●	32	30	300	22	≥40	TNM. 2204..			AMK-04	AKV-02-M6x22	AATN-3-0015	APM-02	ABPL-01	AAL-03-3
S40U MTQNR/L 22	●	●	40	37.5	350	27	≥50		AMK-04	AKV-02-M6x22			AATN-3-0015	APM-02		
S50V MTQNR/L 22	●	●	50	47	400	35	≥63						AMK-04	AKV-02-M6x22		

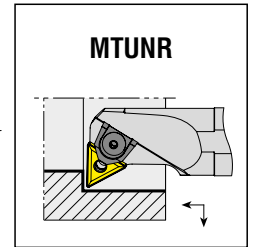
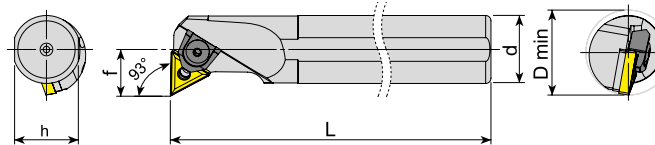

Takım Kodu Ordering Code	Stok Stock		Takım Ölçüleri (mm) Dimension (mm)					Kesici Uç Insert	Yedek Parçaları Spare Parts							
	R	L	d	h	L	f	D min		Baskı Pabucu Wedge Clamp	Pabuç Vidası Clamp Screw	Aitlik Shim	Pim Pin	Pul Stamp	Anahtar Allen Key		
S20R MTUNR/L 16	●	●	20	18.3	200	13	≥25	TNM. 1604..	AMK-02	AKV-17-M5x15	-	APM-03	-	ABPL-01	AAL-03-3	
S25S MTUNR/L 16	●	●	25	23	250	17	≥32		AMK-04	AKV-02-M6x22	AATN-2-0002	APM-14	-			
S32T MTUNR/L 16	●	●	32	30	300	22	≥40				AMK-04	AKV-02-M6x22				AATN-2-0002
S40U MTUNR/L 16	●	●	40	37.5	350	27	≥50		AMK-04	AKV-02-M6x22			AATN-3-0015			APM-02
S50V MTUNR/L 16	●	○	50	47	400	35	≥63	TNM. 2204..			AMK-04	AKV-02-M6x22	AATN-3-0015	APM-02	ABPL-01	AAL-03-3
S32T MTUNR/L 22	●	●	32	30	300	22	≥40		AMK-04	AKV-02-M6x22			AATN-3-0015	APM-02		
S40U MTUNR/L 22	●	●	40	37.5	350	27	≥50						AMK-04	AKV-02-M6x22		
S50V MTUNR/L 22	●	●	50	47	400	35	≥63		AMK-04	AKV-02-M6x22						

R: Sağ/Right L: Sol/Left ● Stokta/In Stock ○ Stokta Yok/Non Stock Item

Sipariş Örneği/Ordering Example : 1 ad./pcs. S20R MTQNR 16

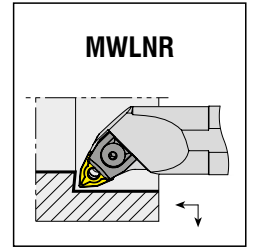
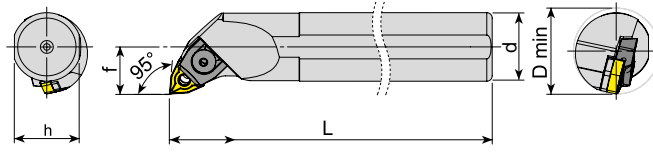

Takım Kodu Ordering Code	Stok Stock		Takım Ölçüleri (mm) Dimension (mm)					Kesici Uç Insert	Yedek Parçaları Spare Parts						
	R	L	d	h	L	f	D min		Baskı Pabucu Wedge Clamp	Pabuç Vidası Clamp Screw	Altlık Shim	Pim Pin	Pul Stamp	Anahtar Allen Key	
S16P MWLNR/L 06	●	●	16	14.8	170	11	≥20	WNM. 0604..			-	APM-09	-	AAL-03-3	
S20R MWLNR/L 06	●	●	20	18.3	200	13	≥25					AKV-04-M5x17			APM-10
S25S MWLNR/L 06	●	●	25	23	250	17	≥32					AKV-27-M6x20			APM-08
S25S MWLNR/L 08	●	●	25	23	250	17	≥32	WNM. 0804..			AAWN-3-0001	APM-04	ABPL-01		
S32T MWLNR/L 08	●	●	32	30	300	22	≥40					APM-02			
S40U MWLNR/L 08	●	●	40	37.5	350	27	≥50								

R: Sağ/Right L: Sol/Left ● Stokta/In Stock ○ Stokta Yok/Non Stock Item

Sipariş Örneği/Ordering Example : 1 ad./pcs. S16P MWLNR 06





*konusulan
the spoken kalite...
quality...*

P-SİSTEM

P-SİSTEM DELİK TORNA KATERLERİ
P-SYSTEM BORING BARS



www.akkо.com.tr

Дистрибьютер ООО "Ресурс Плюс"
+7 (351) 247-74-40; info@rp-ural.ru

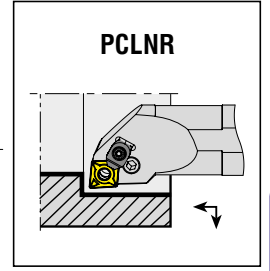
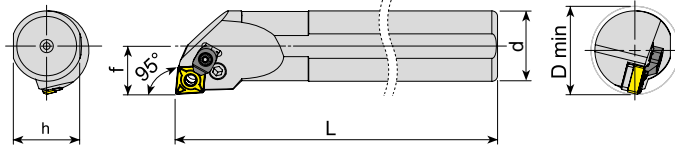

Takım Kodu Ordering Code	Stok Stock		Takım Ölçüleri (mm) Dimension (mm)				Kesici Uç Insert	Yedek Parçaları Spare Parts								
	R	L	d	h	L	f		D min	Levye Lever	Levye Vidası Lever Screw	Altlık Shim	Altlık Yayı Shim Spring	Baskı Parçası Wedge Clamp	Baskı Vidası Clamp Screw	Anahtar Allen Key	
S16P PCLNR/L 09	●	●	16	14.8	170	11	≥20	CNM. 0903..	APL-07	ALV-07-M6x13	-	-	-	-	-	-
S20R PCLNR/L 09	●	●	20	18.3	200	13	≥25		APL-01	ALV-01-M6x14	AACN-2-0002	AAY-01	-	-	-	-
S25S PCLNR/L 09	○	○	25	23	250	17	≥32	CNM. 1204..	APL-02	ALV-08-M8x16	AACN-3-0001	AAY-02	ACK-05	1515-M4x11	AAL-03-3	
S25S PCLNR/L 12C	●	●	25	23	250	17	≥32			ALV-03-M8x19						
S32T PCLNR/L 12C	●	●	32	30	300	22	≥40	CNM. 1606..	APL-04	ALV-04-M8x22	AACN-3-0002	AAY-03	ACK-09	AAV-05-M6x15	AAL-05-4	
S40U PCLNR/L 12C	●	●	40	37.5	350	27	≥50									
S50V PCLNR/L 12C	●	●	50	47	400	35	≥63	CNM. 1906..	APL-05	ALV-05-M10x27	AACN-3-0003	AAY-04	ACK-09	AAV-05-M6x15	AAL-05-4	
S32T PCLNR/L 16C	●	●	32	30	300	22	≥40									
S40U PCLNR/L 16C	●	●	40	37.5	350	27	≥50	CNM. 1204..	APL-02	ALV-03-M8x19	AACN-3-0001	AAY-02	ACK-05	1515-M4x11	AAL-03-3	
S50V PCLNR/L 16C	●	●	50	47	400	35	≥63									
S40U PCLNR/L 19C	●	●	40	37.5	350	27	≥50	CNM. 1606..	APL-04	ALV-04-M8x22	AACN-3-0002	AAY-03	ACK-09	AAV-05-M6x15	AAL-05-4	
S50V PCLNR/L 19C	●	●	50	47	400	35	≥63									
A25R PCLNR/L 12C	●	●	25	23	200	17	≥32	CNM. 1906..	APL-05	ALV-05-M10x27	AACN-3-0003	AAY-04	ACK-09	AAV-05-M6x15	AAL-05-4	
A32S PCLNR/L 12C	●	●	32	30	250	22	≥40									
A40T PCLNR/L 12C	●	●	40	37.5	300	27	≥50	CNM. 1204..	APL-02	ALV-03-M8x19	AACN-3-0001	AAY-02	ACK-05	1515-M4x11	AAL-03-3	
A50U PCLNR/L 12C	●	●	50	47	350	35	≥63									
A32S PCLNR/L 16C	●	●	32	30	250	22	≥40	CNM. 1606..	APL-04	ALV-04-M8x22	AACN-3-0002	AAY-03	ACK-09	AAV-05-M6x15	AAL-05-4	
A40T PCLNR/L 16C	●	●	40	37.5	300	27	≥50									
A50U PCLNR/L 16C	●	●	50	47	350	35	≥63	CNM. 1906..	APL-05	ALV-05-M10x27	AACN-3-0003	AAY-04	ACK-09	AAV-05-M6x15	AAL-05-4	
A40T PCLNR/L 19C	●	●	40	37.5	300	27	≥50									
A50U PCLNR/L 19C	●	●	50	47	350	35	≥63									

R: Sağ/Right L: Sol/Left ● Stokta/In Stock ○ Stokta Yok/Non Stock Item

Sipariş Örneği/Ordering Example : 1 ad./pcs. S16P PCLNR 09

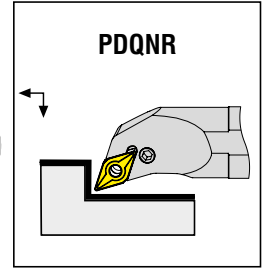
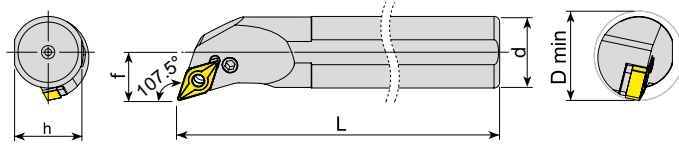

Takım Kodu Ordering Code	Stok Stock		Takım Ölçüleri (mm) Dimension (mm)					Kesici Uç Insert	Yedek Parçaları Spare Parts						
	R	L	d	h	L	f	D min		Levyeye Lever	Levyeye Vidası Lever Screw	Altılık Shim	Altılık Yayı Shim Spring	Baskı Parçası Wedge Clamp	Baskı Vidası Clamp Screw	Anahtar Allen Key
	●	○													
S20R PDQNR/L 11	○	○	20	18.3	200	13	≥25	DNM. 1104..	APL-01	ALV-01-M6x14 ALV-02-M6x17	AADN-SD317	AAAY-01			AAL-02-2.5
S25S PDQNR/L 11	●	●	25	23	250	17	≥32								
S32T PDQNR/L 15	●	●	32	30	300	22	≥40	DNM. 1506..	APL-03	ALV-03-M8x19	AADN-3-0001	AAAY-02	-	-	AAL-03-3
S40U PDQNR/L 15	●	●	40	37.5	350	27	≥50								
S50V PDQNR/L 15	●	●	50	47	400	35	≥63	DNM. 1504..	APL-03	ALV-03-M8x19	AADN-2-0003	AAAY-02	-	-	AAL-03-3
S32T PDQNR/L 1504	●	●	32	30	300	22	≥40								
S40U PDQNR/L 1504	●	●	40	37.5	350	27	≥50	DNM. 1506..	APL-03	ALV-03-M8x19	AADN-3-0001	AAAY-02	-	-	AAL-03-3
S50V PDQNR/L 1504	●	●	50	47	400	35	≥63								
A20P PDQNR/L 11	●	●	20	18.3	170	13	≥25	DNM. 1104..	APL-01	ALV-01-M6x14 ALV-02-M6x17	AADN-SD317	AAAY-01	-	-	AAL-02-2.5
A25R PDQNR/L 11	●	●	25	23	200	17	≥32								
A32S PDQNR/L 15	●	●	32	30	250	22	≥40	DNM. 1506..	APL-03	ALV-03-M8x19	AADN-3-0001	AAAY-02	-	-	AAL-03-3
A40T PDQNR/L 15	●	●	40	37.5	300	27	≥50								
A50U PDQNR/L 15	●	●	50	47	350	35	≥63	DNM. 1504..	APL-03	ALV-03-M8x19	AADN-2-0003	AAAY-02	-	-	AAL-03-3
A32S PDQNR/L 1504	●	○	32	30	250	22	≥40								
A40T PDQNR/L 1504	●	○	40	37.5	300	27	≥50								

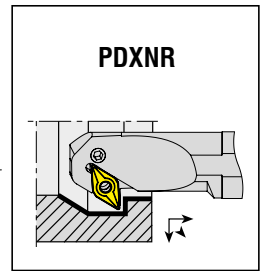
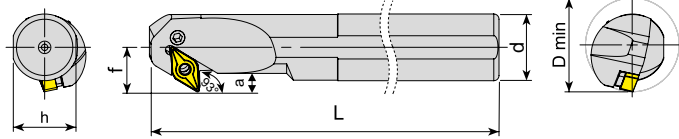

Takım Kodu Ordering Code	Stok Stock		Takım Ölçüleri (mm) Dimension (mm)						Kesici Uç Insert	Yedek Parçaları Spare Parts						
	R	L	d	h	L	f	a	D min		Levyeye Lever	Levyeye Vidası Lever Screw	Altılık Shim	Altılık Yayı Shim Spring	Baskı Parçası Wedge Clamp	Baskı Vidası Clamp Screw	Anahtar Allen Key
	●	○														
S32T PDXNR/L 15	●	●	32	30	300	25	12	≥45	DNM. 1506..	APL-03	ALV-08-M8x16 ALV-03-M8x19	AADN-3-0001	AAAY-02	-	-	AAL-03-3
S40U PDXNR/L 15	●	●	40	37.5	350	27	14	≥50								
S50V PDXNR/L 15	●	●	50	47	400	35	19	≥63								

R: Sağ/Right L: Sol/Left ● Stokta/In Stock ○ Stokta Yok/Non Stock Item
Not: "a" ölçüleri R0.8'e göre verilmiştir.
Note: Dimensions of "a" are given according to R.08.

Sipariş Örneği/Ordering Example : 1 ad./pcs. S20R PDQNR 11

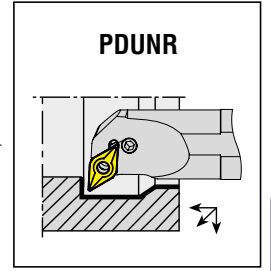
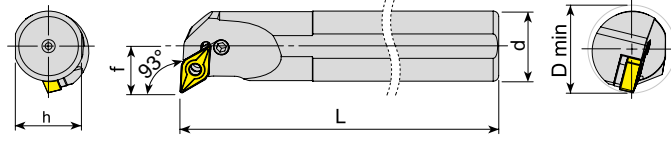

Takım Kodu Ordering Code	Stok Stock		Takım Ölçüleri (mm) Dimension (mm)				Kesici Uç Insert	Yedek Parçaları Spare Parts							
	R	L	d	h	L	f		D min	Levyeye Lever	Levyeye Vidası Lever Screw	Altılık Shim	Altılık Yayı Shim Spring	Baskı Parçası Wedge Clamp	Baskı Vidası Clamp Screw	Anahtar Allen Key
S20R PDUNR/L 11	●	●	20	18.3	200	13	≥25	DNM. 1104..	APL-01	ALV-01-M6x14	AADN-SD317	AAY-01	-	-	AAL-02-2.5
S25S PDUNR/L 11	●	●	25	23	250	17	≥32			ALV-02-M6x17					
S25S PDUNR/L 15	●	●	25	23	250	19	≥32	DNM. 1506..	APL-03	ALV-08-M8x16	AADN-3-0001	AAY-02	-	-	AAL-03-3
S32T PDUNR/L 15	●	●	32	30	300	22	≥40			ALV-03-M8x19					
S40U PDUNR/L 15	●	●	40	37.5	350	27	≥50	DNM. 1104..	APL-01	ALV-01-M6x14	AADN-SD317	AAY-01	-	-	AAL-02-2.5
S50V PDUNR/L 15	●	●	50	47	400	35	≥63			ALV-02-M6x17					
A20P PDUNR/L 11	●	○	20	18.3	170	13	≥25	DNM. 1506..	APL-03	ALV-03-M8x19	AADN-3-0001	AAY-02	-	-	AAL-03-3
A25R PDUNR/L 11	●	○	25	23	200	17	≥32			ALV-03-M8x19					
A32S PDUNR/L 11	●	○	32	30	250	22	≥40	DNM. 1104..	APL-01	ALV-01-M6x14	AADN-SD317	AAY-01	-	-	AAL-02-2.5
A32S PDUNR/L 15	●	○	32	30	250	22	≥40			ALV-02-M6x17					
A40T PDUNR/L 15	●	○	40	37.5	300	27	≥50	DNM. 1506..	APL-03	ALV-03-M8x19	AADN-3-0001	AAY-02	-	-	AAL-03-3
A50U PDUNR/L 15	●	○	50	47	350	35	≥63			ALV-03-M8x19					

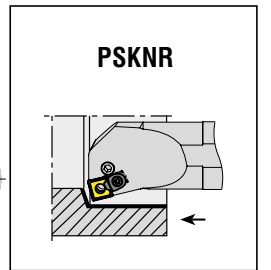
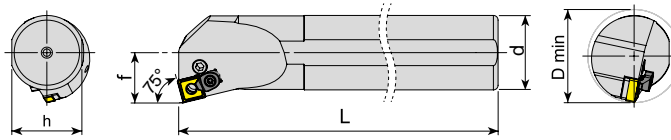

Takım Kodu Ordering Code	Stok Stock		Takım Ölçüleri (mm) Dimension (mm)				Kesici Uç Insert	Yedek Parçaları Spare Parts							
	R	L	d	h	L	f		D min	Levyeye Lever	Levyeye Vidası Lever Screw	Altılık Shim	Altılık Yayı Shim Spring	Baskı Parçası Wedge Clamp	Baskı Vidası Clamp Screw	Anahtar Allen Key
S25S PSKNR/L 12C	●	●	25	23	250	17	≥32	SNM. 1204..	APL-02	ALV-08-M8x16	AASN-3-0004	AAY-02	ACK-05	1515-M4x11	AAL-03-3
S32T PSKNR/L 12C	●	●	32	30	300	22	≥40			ALV-03-M8x19					
S40U PSKNR/L 12C	●	●	40	37.5	350	27	≥50			ALV-03-M8x19					
S50V PSKNR/L 12C	●	●	50	47	400	35	≥63	SNM. 1506..	APL-04	ALV-04-M8x22	AASN-3-0023	AAY-03	-	-	AAL-05-4
S32T PSKNR/L 15	○	○	32	30	300	22	≥40			ALV-04-M8x22					
S40U PSKNR/L 15	○	○	40	37.5	350	27	≥50			ALV-04-M8x22					
S50V PSKNR/L 15	○	○	50	47	400	35	≥63			ALV-04-M8x22					

R: Sağ/Right L: Sol/Left ● Stokta/In Stock ○ Stokta Yok/Non Stock Item

Sipariş Örneği/Ordering Example : 1 ad./pcs. S20R PDUNR 11

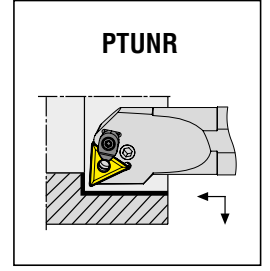
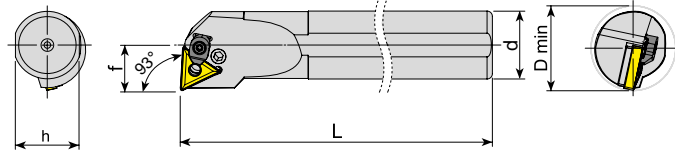

Takım Kodu Ordering Code	Stok Stock		Takım Ölçüleri (mm) Dimension (mm)				Kesici Uç Insert	Yedek Parçaları Spare Parts														
	R	L	d	h	L	f		D min	Levye Lever	Levye Vidası Lever Screw	Altık Shim	Altık Yayı Shim Spring	Baskı Parçası Wedge Clamp	Baskı Vidası Clamp Screw	Anahtar Allen Key							
S16P PTUNR/L 16	●	●	16	14.8	170	11	≥20	TNM. 1604..	APL-08	ALV-07-M6x13	-	-	-	-	AAL-02-2.5							
S20R PTUNR/L 16	●	●	20	18.3	200	13	≥25		APL-01	ALV-01-M6x14	AATN-3-0025	AAY-01										
S25S PTUNR/L 16C	●	●	25	23	250	17	≥32			ALV-02-M6x17												
S32T PTUNR/L 16C	●	●	32	30	300	22	≥40											ALV-03-M8x19	AATN-3-0015	AAY-02	ACK-05	1515-M4x11
S40U PTUNR/L 16C	●	●	40	37.5	350	27	≥50															
S32T PTUNR/L 22C	●	●	32	30	300	22	≥40	TNM. 2204..					AAL-03-3									
S40U PTUNR/L 22C	●	●	40	37.5	350	27	≥50							ALV-03-M8x19	AATN-3-0015	AAY-02	ACK-05	1515-M4x11				
S50V PTUNR/L 22C	●	●	50	47	400	35	≥63												APL-02			

R: Sağ/Right L: Sol/Left ● Stokta/In Stock ○ Stokta Yok/Non Stock Item

Sipariş Örneği/Ordering Example : 1 ad./pcs. S16P PTUNR 16



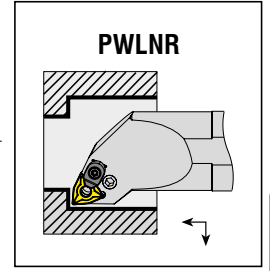
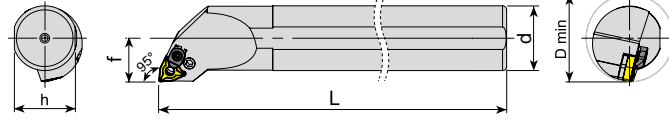

Takım Kodu Ordering Code	Stok Stock		Takım Ölçüleri (mm) Dimension (mm)				Kesici Uç Insert	Yedek Parçaları Spare Parts							
	R	L	d	h	L	f		D min	Levyeye Lever	Levyeye Vidası Lever Screw	Altılık Shim	Altılık Yayı Shim Spring	Baskı Parçası Wedge Clamp	Baskı Vidası Clamp Screw	Anahtar Allen Key
S20R PWLNR/L 06	●	●	20	18.3	200	13	≥25	WNM. 0604..	APL-01	ALV-01-M6x14 ALV-02-M6x17	AAWN-SW317	AAY-01	-	-	AAL-02-2.5
S25S PWLNR/L 06	●	●	25	23	250	17	≥32								
S32T PWLNR/L 06	●	●	32	30	300	22	≥40								
S25S PWLNR/L 08C	●	●	25	23	250	17	≥32	WNM. 0804..	APL-02	ALV-03-M8x19	AAWN-3-0001	AAY-02	ACK-05	1515-M4x11	AAL-03-3
S32T PWLNR/L 08C	●	●	32	30	300	22	≥40								
S40U PWLNR/L 08C	●	●	40	37.5	350	27	≥50								
S50V PWLNR/L 08C	●	●	50	47	400	35	≥63	WNM. 0604..	APL-01	ALV-01-M6x14 ALV-02-M6x17	AAWN-SW317	AAY-01	-	-	AAL-02-2.5
A20P PWLNR/L 06	●	●	20	18.3	170	13	≥25								
A25R PWLNR/L 06	●	●	25	23	200	17	≥32								
A32S PWLNR/L 06	●	●	32	30	250	22	≥40	WNM. 0804..	APL-02	ALV-03-M8x19	AAWN-3-0001	AAY-02	ACK-05	1515-M4x11	AAL-03-3
A25R PWLNR/L 08C	●	●	25	23	200	17	≥32								
A32S PWLNR/L 08C	●	●	32	30	250	22	≥40								
A40T PWLNR/L 08C	●	●	40	37.5	300	27	≥50	WNM. 0804..	APL-02	ALV-03-M8x19	AAWN-3-0001	AAY-02	ACK-05	1515-M4x11	AAL-03-3
A50U PWLNR/L 08C	●	●	50	47	350	35	≥63								

R: Sağ/Right L: Sol/Left ● Stokta/In Stock ○ Stokta Yok/Non Stock Item

Sipariş Örneği/Ordering Example : 1 ad./pcs. S20R PWLNR 06





*konusulan
the spoken kalite...
quality...*

S-SİSTEM

S-SİSTEM DELİK TORNA KATERLERİ
S-SYSTEM BORING BARS



www.akkо.com.tr

Дистрибутор ООО "Ресурс Плюс"
+7 (351) 247-74-40; info@rp-ural.ru

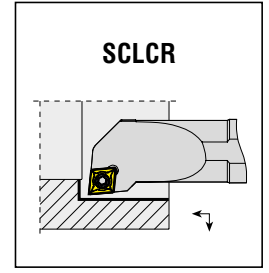
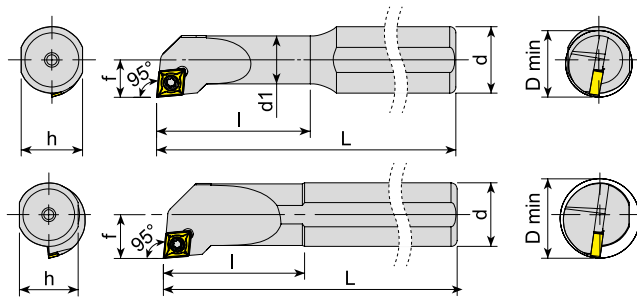

Takım Kodu Ordering Code	Stok Stock		Takım Ölçüleri (mm) Dimension (mm)						Kesici Uç Insert	Yedek Parçaları Spare Parts				
	R	L	d	d1	h	l	L	f		D min	Sıkma Vidası Screw	Aitlik Shim	Aitlik Vidası Shim Screw	Tork Anahtar Torx Key
S0608H SCLCR/L 03	●	○	08	5	7.3	18	100	3	≥6	CC.T 030102	4006-M1.6x3.2			80-T06
S0608H SCLCR/L 06	●	●	08	6	7.3	25	100	4.5	≥8		4008-M2.5x4.5			
S08H SCLCR/L 06	●	●	08	8	7.3	20	100	06	≥11	CC.T 0602..	4008-M2.5x6	-	-	80-T08
S10K SCLCR/L 06	●	●	10	10	09	25	125	07	≥13					
S12K SCLCR/L 06	●	●	12	12	11	25	125	09	≥16					
S1216P SCLCR/L 06	●	○	16	11.5	14.8	37	170	09	≥16	CC.T 09T3..	4015-M3.5x8			80-T15
S16P SCLCR/L 06	●	●	16	16	14.8	35	170	11	≥20		4015-M3.5x9	-	-	
S12K SCLCR/L 09	●	●	12	12	11	30	125	09	≥16	CC.T 1204..	4015-M3.5x12	AACN-2-0001	AAV-08-M3.5x8	80-T20
S1416P SCLCR/L 09	●	●	16	14	14.8	45	170	9.5	≥17		4020-M4.5x12	AACN-2-0003	AAV-10-M4.5x8	
S16P SCLCR/L 09	●	●	16	16	14.8	35	170	11	≥20		1020-M4.5x16		AAV-07-M4.5x13	
S1620R SCLCR/L 09	●	●	20	16	18.3	50	200	11	≥20	CC.T 0602..	4008-M2.5x6	-	-	80-T08
S20R SCLCR/L 09	●	●	20	20	18.3	40	200	13	≥25					
S25S SCLCR/L 09	●	●	25	25	23	50	250	17	≥32	CC.T 09T3..	4015-M3.5x9	-	-	80-T15
S32T SCLCR/L 09	●	●	32	32	30	60	300	22	≥40		4015-M3.5x12	AACN-2-0001	AAV-08-M3.5x8	
S25S SCLCR/L 12	●	●	25	25	23	50	250	17	≥32	CC.T 1204..	4020-M4.5x12	AACN-2-0003	AAV-10-M4.5x8	80-T20
S32T SCLCR/L 12	●	●	32	32	30	60	300	22	≥40					
S40U SCLCR/L 12	●	●	40	40	37.5	70	350	27	≥50					
A08H SCLCR/L 06	●	●	08	8	7.3	20	100	06	≥11	CC.T 0602..	4008-M2.5x6	-	-	80-T08
A10H SCLCR/L 06	●	●	10	10	09	25	100	07	≥13					
A12H SCLCR/L 06	●	●	12	12	11	25	100	09	≥16					
A16M SCLCR/L 09	●	●	16	16	14.8	35	150	11	≥20	CC.T 09T3..	4015-M3.5x9	-	-	80-T15
A20P SCLCR/L 09	●	●	20	20	18.3	40	170	13	≥25		4015-M3.5x12	AACN-2-0001	AAV-08-M3.5x8	
A25R SCLCR/L 09	●	●	25	25	23	50	200	17	≥32	CC.T 1204..	4020-M4.5x12	AACN-2-0003	AAV-10-M4.5x8	80-T20
A32S SCLCR/L 09	●	●	32	32	30	60	250	22	≥40					
A25R SCLCR/L 12	●	●	25	25	23	50	200	17	≥32					

R: Sağ/Right L: Sol/Left ● Stokta/In Stock ○ Stokta Yok/Non Stock Item

Sipariş Örneği/Ordering Example : 1 ad./pcs. S0608H SCLCR 06

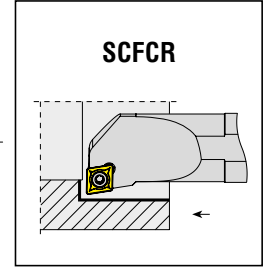
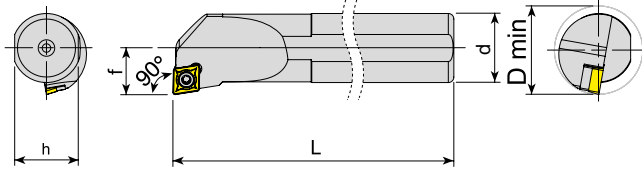

Takım Kodu Ordering Code	Stok Stock		Takım Ölçüleri (mm) Dimension (mm)					Kesici Uç Insert	Yedek Parçaları Spare Parts			
	R	L	d	h	L	f	D min		Sıkma Vidası Screw	Altlık Shim	Altlık Vidası Shim Screw	Tork Anahtar Torx Key
S08H SCFCR/L 06	●	●	08	7.3	100	06	≥11	CC.T 0602..	4008-M2.5x6	-	-	80-T08
S10K SCFCR/L 06	●	●	10	09	125	07	≥13					
S12K SCFCR/L 06	●	●	12	11	125	09	≥16					
S12K SCFCR/L 09	●	●	12	11	125	09	≥16	CC.T 09T3..	4015-M3.5x8	-	-	80-T15
S16P SCFCR/L 09	●	●	16	14.8	170	11	≥20					
S20R SCFCR/L 09	●	●	20	18.3	200	13	≥25					
S25S SCFCR/L 09	●	●	25	23	250	17	≥32	CC.T 1204..	4015-M3.5x12	AACN-2-0001	AAV-08-M3.5x8	80-T20
S25S SCFCR/L 12	○	○	25	23	250	17	≥32					
S32T SCFCR/L 12	○	○	32	30	300	22	≥40					
S40U SCFCR/L 12	○	○	40	37.5	350	27	≥50		1020-M4.5x16		AAV-07-M4.5x13	

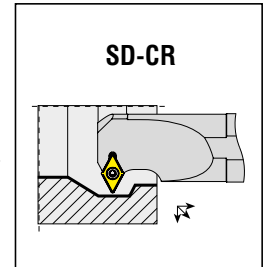
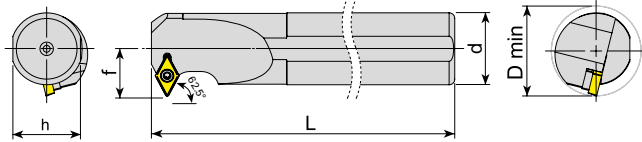

Takım Kodu Ordering Code	Stok Stock		Takım Ölçüleri (mm) Dimension (mm)					Kesici Uç Insert	Yedek Parçaları Spare Parts			
	R	L	d	h	L	f	D min		Sıkma Vidası Screw	Altlık Shim	Altlık Vidası Shim Screw	Tork Anahtar Torx Key
S10K SD-CR/L 07	●	●	10	9	125	07	≥13	DC.T 0702..	4008-M2.5x6	-	-	80-T08
S12K SD-CR/L 07	●	●	12	11	125	09	≥16					
S16P SD-CR/L 07	●	●	16	14.8	170	11	≥20					
S20R SD-CR/L 07	○	○	20	18.3	200	13	≥25	DC.T 11T3..	4015-M3.5x11	-	-	80-T15
S16P SD-CR/L 11	●	●	16	14.8	170	14	≥22					
S20R SD-CR/L 11	●	●	20	18.3	200	15	≥25					
S25S SD-CR/L 11	●	●	25	23	250	18	≥32	AACN-2-0001	4015-M3.5x14	AADN-2-0001	AAV-06-M3.5x11	80-T15
S32T SD-CR/L 11	●	●	32	30	300	22	≥40					
S40U SD-CR/L 11	●	●	40	37.5	350	27	≥50					

R: Sağ/Right L: Sol/Left ● Stokta/In Stock ○ Stokta Yok/Non Stock Item

Sipariş Örneği/Ordering Example : 1 ad./pcs. S08H SCFCR 06

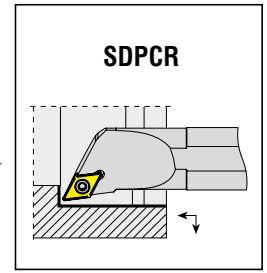
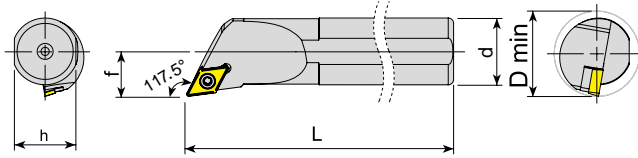

Takım Kodu Ordering Code	Stok Stock		Takım Ölçüleri (mm) Dimension (mm)				Kesici Uç Insert	Yedek Parçaları Spare Parts				
	R	L	d	h	L	f		D min	Sıkma Vidası Screw	Altılık Shim	Altılık Vidası Shim Screw	Tork Anahtar Torx Key
S10K SDPCR/L 07	●	●	10	09	125	07	≥13	DC.T 0702..	4008-M2.5x6	-	-	80-T08
S12K SDPCR/L 07	●	●	12	11	125	09	≥16					
S16P SDPCR/L 11	●	●	16	14.8	170	11	≥20	DC.T 11T3..	4015-M3.5x9	-	-	80-T15
S20R SDPCR/L 11	●	●	20	18.3	200	13	≥25		4015-M3.5x11			
S25S SDPCR/L 11	●	●	25	23	250	17	≥32		4015-M3.5x12			

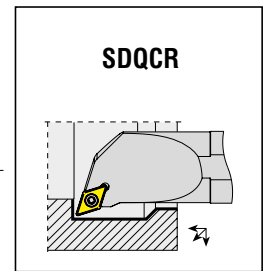
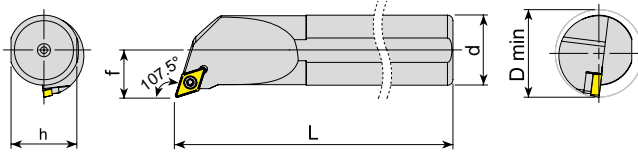

Takım Kodu Ordering Code	Stok Stock		Takım Ölçüleri (mm) Dimension (mm)				Kesici Uç Insert	Yedek Parçaları Spare Parts					
	R	L	d	h	L	f		D min	Sıkma Vidası Screw	Altılık Shim	Altılık Vidası Shim Screw	Tork Anahtar Torx Key	
S10K SDQCR/L 07	●	●	10	09	125	07	≥13	DC.T 0702..	4008-M2.5x6	-	-	80-T08	
S12K SDQCR/L 07	●	●	12	11	125	09	≥16						
S16P SDQCR/L 07	●	●	16	14.8	170	11	≥20	DC.T 11T3..	4015-M3.5x9	-	-	80-T15	
S20R SDQCR/L 07	●	●	20	18.3	200	13	≥25		4015-M3.5x11				
S16P SDQCR/L 11	●	●	16	14.8	170	11	≥20		4015-M3.5x12				AADN-2-0001
S20R SDQCR/L 11	●	●	20	18.3	200	13	≥25	4015-M3.5x14	-	-	80-T15		
S25S SDQCR/L 11	●	●	25	23	250	17	≥32						
S32T SDQCR/L 11	●	●	32	30	300	22	≥40	DC.T 0702..	4008-M2.5x6	-	-	80-T08	
S40U SDQCR/L 11	●	●	40	37.5	350	27	≥50						
A10H SDQCR/L 07	●	●	10	09	100	07	≥13	DC.T 0702..	4008-M2.5x6	-	-	80-T08	
A12H SDQCR/L 07	●	●	12	11	100	09	≥16						
A16M SDQCR/L 07	●	●	16	14.8	150	11	≥20	DC.T 11T3..	4015-M3.5x9	-	-	80-T15	
A20P SDQCR/L 07	●	●	20	18.3	170	13	≥25						4015-M3.5x11
A16M SDQCR/L 11	●	●	16	14.8	150	11	≥20						4015-M3.5x12
A20P SDQCR/L 11	●	●	20	18.3	170	13	≥25	4015-M3.5x14	-	-	80-T15		
A25R SDQCR/L 11	●	●	25	23	200	17	≥32						
A32S SDQCR/L 11	●	●	32	30	250	22	≥40	AADN-2-0001	AAV-06-M3.5x11				

R: Sağ/Right L: Sol/Left ● Stokta/In Stock ○ Stokta Yok/Non Stock Item

Sipariş Örneği/Ordering Example : 1 ad./pcs. S10K SDPCR 07

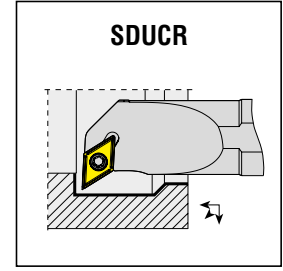
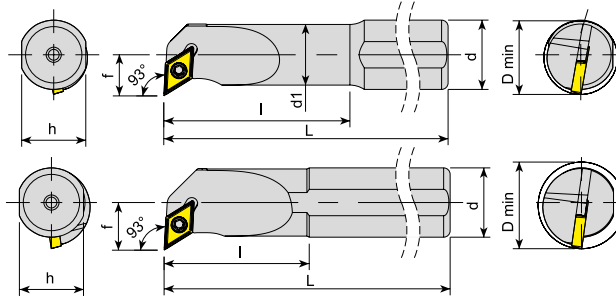

Takım Kodu Ordering Code	Stok Stock		Takım Ölçüleri (mm) Dimension (mm)						Kesici Uç Insert	Yedek Parçaları Spare Parts				
	R	L	d	d1	h	l	L	f		D min	Sıkma Vidası Screw	Altık Shim	Altık Vidası Shim Screw	Tork Anahtar Torx Key
S0810K SDUCR/L 07	●	●	10	8	09	30	125	08	≥13	DC.T 0702..	4008-M2.5x6	-	-	80-T08
S10K SDUCR/L 07	●	●	10	10	09	25	125	08	≥13					
S12K SDUCR/L 07	●	●	12	12	11	25	125	09	≥16					
S1216P SDUCR/L 07	●	○	16	11.5	14.8	37	170	09	≥16					
S1416P SDUCR/L 07	●	●	16	14	14.8	45	170	9.5	≥17					
S16P SDUCR/L 07	●	●	16	16	14.8	35	170	11	≥20					
S20R SDUCR/L 07	●	●	20	20	18.3	40	200	13	≥25					
S1416P SDUCR/L 11	●	○	16	14	14.8	45	170	11	≥18	DC.T 11T3..	4015-M3.5x9	-	-	80-T15
S16P SDUCR/L 11	●	●	16	16	14.8	35	170	11	≥20					
S1620R SDUCR/L 11	●	○	20	16	18.3	50	200	11	≥20					
S20R SDUCR/L 11	●	●	20	20	18.3	40	200	13	≥25					
S25S SDUCR/L 11	●	●	25	25	23	50	250	17	≥32					
S32T SDUCR/L 11	●	●	32	32	30	60	300	22	≥40					
S40U SDUCR/L 11	●	●	40	40	37.5	70	350	27	≥50					
S50V SDUCR/L 11	●	○	50	50	47	80	400	35	≥63					
A0810H SDUCR/L 07	●	○	10	8	09	30	100	08	≥13	DC.T 0702..	4008-M2.5x6	-	-	80-T08
A10H SDUCR/L 07	●	●	10	10	09	25	100	08	≥13					
A12H SDUCR/L 07	●	●	12	12	11	25	100	09	≥16					
A16M SDUCR/L 07	●	●	16	16	14.8	35	150	11	≥20					
A20P SDUCR/L 07	●	●	20	20	18.3	40	170	13	≥25					
A16M SDUCR/L 11	●	●	16	16	14.8	35	150	11	≥20					
A20P SDUCR/L 11	●	●	20	20	18.3	40	170	13	≥25					
A25R SDUCR/L 11	●	●	25	25	23	50	200	17	≥32	DC.T 11T3..	4015-M3.5x9 4015-M3.5x11 4015-M3.5x12 4015-M3.5x14	-	-	80-T15
A32S SDUCR/L 11	●	●	32	32	30	60	250	22	≥40					

R: Sağ/Right L: Sol/Left ● Stokta/In Stock ○ Stokta Yok/Non Stock Item

Sipariş Örneği/Ordering Example : 1 ad./pcs. S0810K SDUCR 07



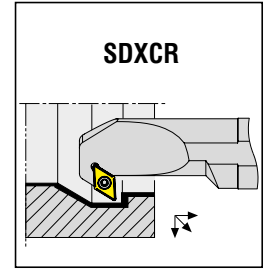
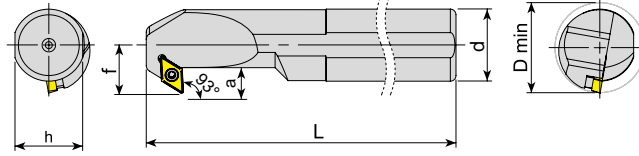

Takım Kodu Ordering Code	Stok Stock		Takım Ölçüleri (mm) Dimension (mm)						Kesici Uç Insert	Yedek Parçaları Spare Parts				
	R	L	d	h	L	f	a	D min		Sıkma Vidası Screw	Altlık Shim	Altlık Vidası Shim Screw	Tork Anahtar Torx Key	
S12K SDXCR/L 07	●	●	12	11	125	09	4.5	≥16	DC.T 0702..			-	-	80-T08
S16P SDXCR/L 07	●	●	16	14.8	170	11	6.5	≥20						
S20R SDXCR/L 07	○	○	20	18.3	200	13	6.5	≥25						
S16P SDXCR/L 11	○	○	16	14.8	170	11	7.5	≥20	DC.T 11T3..			-	-	80-T15
S20R SDXCR/L 11	●	●	20	18.3	200	14	7.5	≥25						
S25S SDXCR/L 11	●	●	25	23	250	17	9	≥32						
S32T SDXCR/L 11	●	●	32	30	300	22	12.5	≥40						
S40U SDXCR/L 11	●	●	40	37.5	350	27	14.5	≥50						

Not: "a" ölçüleri R0.4'e göre verilmiştir.

Note: Dimensions of "a" are given according to R.04.

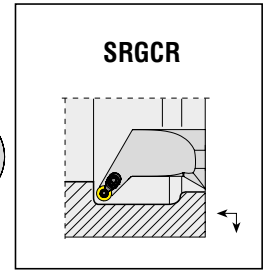
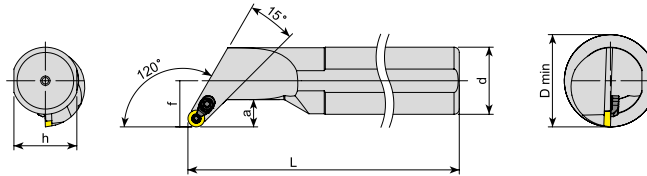

Takım Kodu Ordering Code	Stok Stock		Takım Ölçüleri (mm) Dimension (mm)						Kesici Uç Insert	Yedek Parçaları Spare Parts					
	R	L	d	h	L	f	a	D min		Sıkma Vidası Screw	Altlık Shim	Altlık Vidası Shim Screw	Baskı Pabucu Shim Screw	Pabuç Vidası Shim Screw	Anahtar Allen Key
S16P SRGCR/L 08	●	○	16	14.8	170	11	7	≥22	RCM. 0803..			-	-	-	80-T08
S20R SRGCR/L 08	●	○	20	18.3	200	13	7	≥26							
S25S SRGCR/L 08C	●	○	25	23	250	17	9.5	≥34							
S32T SRGCR/L 08C	●	○	32	30	300	22	13	≥44							
S40U SRGCR/L 08C	●	○	40	37.5	350	27	15	≥54							

R: Sağ/Right L: Sol/Left ● Stokta/In Stock ○ Stokta Yok/Non Stock Item

Sipariş Örneği/Ordering Example : 1 ad./pcs. S12K SDXCR 07

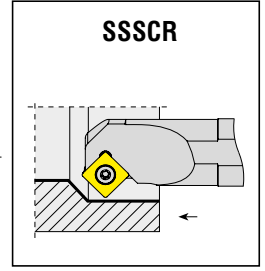
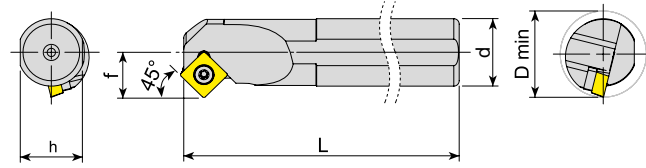

Takım Kodu Ordering Code	Stok Stock		Takım Ölçüleri (mm) Dimension (mm)					Kesici Uç Insert	Yedek Parçaları Spare Parts			
	R	L	d	h	L	f	D min		Sıkma Vidası Screw	Altık Shim	Altık Vidası Shim Screw	Tork Anahtar Torx Key
S16P SSSCR/L 09	●	●	16	14.8	170	11	≥20	SC.T 09T3..	4015-M3.5x9	-	-	80-T15
S20R SSSCR/L 09	●	●	20	18.3	200	13	≥25		4015-M3.5x11	-	-	
S25S SSSCR/L 09	●	●	25	23	250	17	≥32		4015-M3.5x12	AASN-2-0001	AAV-08-M3.5x8	
S25S SSSCR/L 12	●	○	25	23	250	17	≥32	SC.T 1204..	4020-M4.5x12	AASN-2-0004	AAV-10-M4.5x8	80-T20
S32T SSSCR/L 12	●	○	32	30	300	22	≥40		1020-M4.5x16	-	AAV-07-M4.5x13	
S40U SSSCR/L 12	●	○	40	37.5	350	27	≥50		-	-	-	

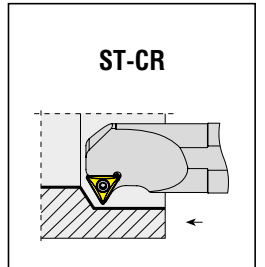
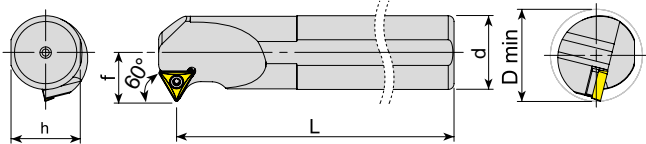

Takım Kodu Ordering Code	Stok Stock		Takım Ölçüleri (mm) Dimension (mm)					Kesici Uç Insert	Yedek Parçaları Spare Parts			
	R	L	d	h	L	f	D min		Sıkma Vidası Screw	Altık Shim	Altık Vidası Shim Screw	Tork Anahtar Torx Key
S12K ST-CR/L 11	●	●	12	11	125	09	≥17	TC.T 1102..	4008-M2.5x6	-	-	80-T08
S16P ST-CR/L 11	●	○	16	14.8	170	11	≥20		-	-	-	
S20R ST-CR/L 11	●	○	20	18.3	200	13	≥25		-	-	-	
S16P ST-CR/L 16	●	●	16	14.8	170	11	≥20	TC.T 16T3..	4015-M3.5x9	-	-	80-T15
S20R ST-CR/L 16	●	●	20	18.3	200	13	≥25		4015-M3.5x11	-	-	
S25S ST-CR/L 16	●	●	25	23	250	17	≥32		-	-	AAV-08-M3.5x8	
S32T ST-CR/L 16	●	●	32	30	300	22	≥40		4015-M3.5x14	AATN-2-0001	AAV-06-M3.5x11	
S40U ST-CR/L 16	●	●	40	37.5	350	27	≥50		-	-	-	

R: Sağ/Right L: Sol/Left ● Stokta/In Stock ○ Stokta Yok/Non Stock Item

Sipariş Örneği/Ordering Example : 1 ad./pcs. S16P SSSCR 09

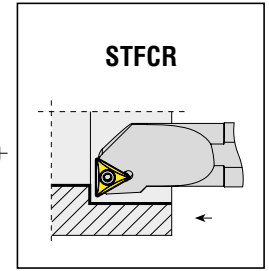
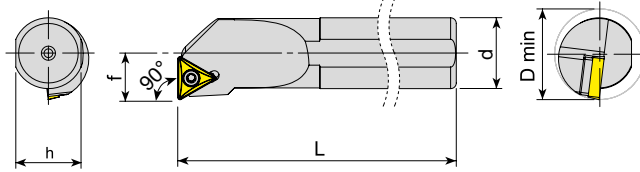

Takım Kodu Ordering Code	Stok Stock		Takım Ölçüleri (mm) Dimension (mm)					Kesici Uç Insert	Yedek Parçaları Spare Parts			
	R	L	d	h	L	f	D min		Sıkma Vidası Screw	Altılık Shim	Altılık Vidası Shim Screw	Tork Anahtar Torx Key
S0610F STFCR/L 06	●	●	10	09	80	4.5	≥08	TC.T 06T1..	3006-M2x4			80-T06
S08H STFCR/L 06	●	●	08	7.3	100	06	≥11					
S10K STFCR/L 09	●	●	10	09	125	07	≥13	TC.T 0902..	3007-M2.2x5	-	-	80-T07
S12K STFCR/L 09	●	●	12	11	125	09	≥17					
S12K STFCR/L 11	●	●	12	11	125	09	≥17	TC.T 1102..	4008-M2.5x6			80-T08
S16P STFCR/L 11	●	●	16	14.8	170	11	≥20					
S20R STFCR/L 11	●	●	20	18.3	200	13	≥25	TC.T 16T3..	4015-M3.5x9 4015-M3.5x11	-	-	80-T15
S16P STFCR/L 16	●	●	16	14.8	170	11	≥20					
S20R STFCR/L 16	●	●	20	18.3	200	13	≥25					
S25S STFCR/L 16	●	●	25	23	250	17	≥32					
S32T STFCR/L 16	●	●	32	30	300	22	≥40	4015-M3.5x14	AATN-2-0001	AAV-08-M3.5x8 AAV-06-M3.5x11	80-T15	
S40U STFCR/L 16	○	○	40	37.5	350	27	≥50					

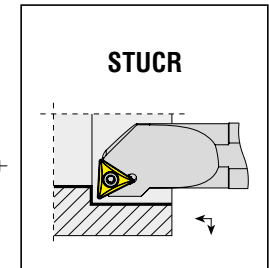
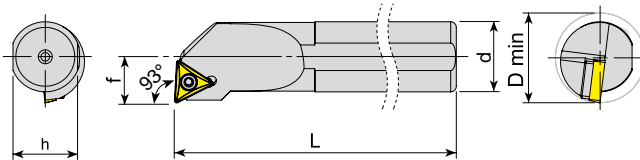





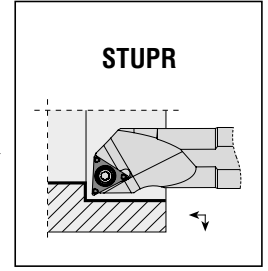
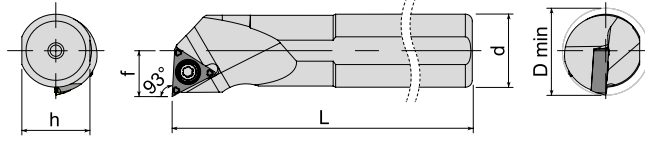

Takım Kodu Ordering Code	Stok Stock		Takım Ölçüleri (mm) Dimension (mm)					Kesici Uç Insert	Yedek Parçaları Spare Parts			
	R	L	d	h	L	f	D min		Sıkma Vidası Screw	Altılık Shim	Altılık Vidası Shim Screw	Tork Anahtar Torx Key
S10K STUCR/L 09	●	●	10	09	125	07	≥13	TC.T 0902..	3007-M2.2x5			80-T07
S12K STUCR/L 09	●	●	12	11	125	09	≥16					
S12K STUCR/L 11	●	●	12	11	125	09	≥17	TC.T 1102..	4008-M2.5x6			80-T08
S16P STUCR/L 11	●	●	16	14.8	170	11	≥20					
S20R STUCR/L 11	●	●	20	18.3	200	13	≥25	TC.T 16T3..	4015-M3.5x9 4015-M3.5x11	-	-	80-T15
S16P STUCR/L 16	●	●	16	14.8	170	11	≥20					
S20R STUCR/L 16	●	●	20	18.3	200	13	≥25					
S25S STUCR/L 16	●	●	25	23	250	17	≥32					
S32T STUCR/L 16	●	●	32	30	300	22	≥40	4015-M3.5x14	AATN-2-0001	AAV-08-M3.5x8 AAV-06-M3.5x11	80-T15	
S40U STUCR/L 16	●	●	40	37.5	350	27	≥50					





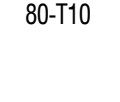

R: Sağ/Right L: Sol/Left ● Stokta/In Stock ○ Stokta Yok/Non Stock Item

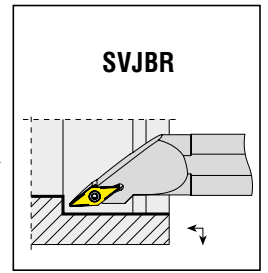
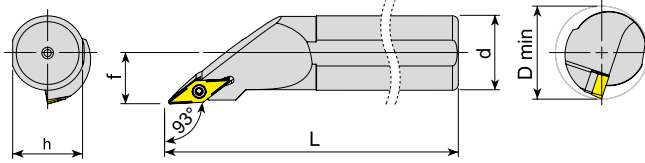
Sipariş Örneği/Ordering Example : 1 ad./pcs. S0610F STFCR 06



Takım Kodu Ordering Code	Stok Stock		Takım Ölçüleri (mm) Dimension (mm)					Kesici Uç Insert	Yedek Parçaları Spare Parts			
	R	L	d	h	L	f	D min		Sıkma Vidası Screw	Altık Shim	Altık Vidası Shim Screw	Tork Anahtar Torx Key
S08H STUPR/L 0802	●	○	08	7.3	100	05	≥10	 TP.. 0802..	 3006-M2x4			 80-T06
S10K STUPR/L 1103	●	○	10	09	125	06	≥12					
S12K STUPR/L 1103	●	○	12	11	125	09	≥16					
S12M STUPR/L 1103	●	○	12	11	150	08	≥16					
S16P STUPR/L 1103	●	○	16	14.8	170	10	≥20					
S16R STUPR/L 1103	●	○	16	14.8	200	10	≥20					
								 4010-M3x6  4010-M3x8	-	-	 80-T10	



Takım Kodu Ordering Code	Stok Stock		Takım Ölçüleri (mm) Dimension (mm)					Kesici Uç Insert	Yedek Parçaları Spare Parts			
	R	L	d	h	L	f	D min		Sıkma Vidası Screw	Altık Shim	Altık Vidası Shim Screw	Tork Anahtar Torx Key
S25S SVJBR/L 16	●	●	25	23	250	17	≥32	 VBM. 1604..	 4015-M3.5x12  4015-M3.5x14		 AAV-08-M3.5x8  AAV-06-M3.5x11	 80-T15
S32T SVJBR/L 16	●	●	32	30	300	22	≥40					
S40U SVJBR/L 16	●	●	40	37.5	350	27	≥50					

R: Sağ/Right L: Sol/Left ● Stokta/In Stock ○ Stokta Yok/Non Stock Item

Sipariş Örneği/Ordering Example : 1 ad./pcs. S08H STUPR 0802

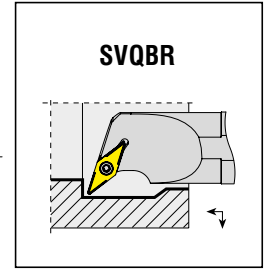
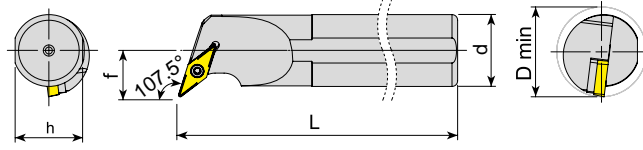

Takım Kodu Ordering Code	Stok Stock		Takım Ölçüleri (mm) Dimension (mm)				Kesici Uç Insert	Yedek Parçaları Spare Parts				
	R	L	d	h	L	f		D min	Sıkma Vidası Screw	Altılık Shim	Altılık Vidası Shim Screw	Tork Anahtar Torx Key
S16P SVQBR/L 11	●	●	16	14.8	170	11	≥20	VBM. 1103..	4008-M2.5x6	-	-	80-T08
S20R SVQBR/L 11	●	●	20	18.3	200	13	≥25					
S25S SVQBR/L 16	●	●	25	23	250	17	≥32	VBM. 1604..	4015-M3.5x14	AAVN-2-0002	AAV-08-M3.5x8	80-T15
S32T SVQBR/L 16	●	●	32	30	300	22	≥40				AAV-06-M3.5x11	
S40U SVQBR/L 16	●	●	40	37.5	350	27	≥50					

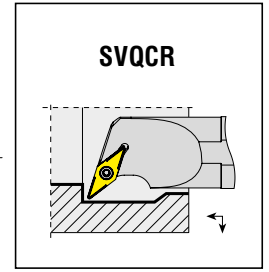
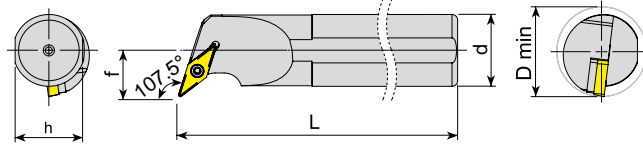

Takım Kodu Ordering Code	Stok Stock		Takım Ölçüleri (mm) Dimension (mm)				Kesici Uç Insert	Yedek Parçaları Spare Parts				
	R	L	d	h	L	f		D min	Sıkma Vidası Screw	Altılık Shim	Altılık Vidası Shim Screw	Tork Anahtar Torx Key
S16P SVQCR/L 11	●	●	16	14.8	170	11	≥20	VC.T 1103..	4008-M2.5x6	-	-	80-T08
S20R SVQCR/L 11	●	●	20	18.3	200	13	≥25					
S25S SVQCR/L 16	●	●	25	23	250	17	≥32	VC.T 1604..	4015-M3.5x14	AAVN-2-0002	AAV-08-M3.5x8	80-T15
S32T SVQCR/L 16	●	●	32	30	300	22	≥40				AAV-06-M3.5x11	
S40U SVQCR/L 16	●	●	40	37.5	350	27	≥50					

R: Sağ/Right L: Sol/Left ● Stokta/In Stock ○ Stokta Yok/Non Stock Item

Sipariş Örneği/Ordering Example : 1 ad./pcs. S16P SVQBR 11

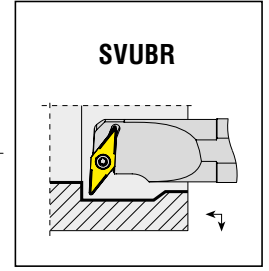
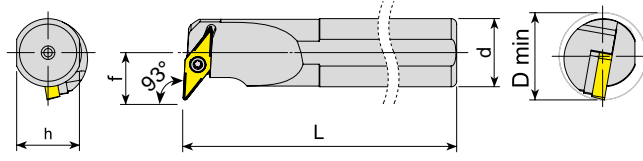

Takım Kodu Ordering Code	Stok Stock		Takım Ölçüleri (mm) Dimension (mm)					Kesici Uç Insert	Yedek Parçaları Spare Parts			
	R	L	d	h	L	f	D min		Sıkma Vidası Screw	Altık Shim	Altık Vidası Shim Screw	Tork Anahtar Torx Key
S16P SVUBR/L 11	●	●	16	14.8	170	12.5	≥20	VBM. 1103..	4008-M2.5x6	-	-	80-T08
S20R SVUBR/L 11	●	●	20	18.3	200	13	≥25					
S25S SVUBR/L 16	●	●	25	23	250	19	≥32	VBM. 1604..	4015-M3.5x14	AAVN-2-0002	AAV-06-M3.5x11	80-T15
S32T SVUBR/L 16	●	●	32	30	300	22	≥40					
S40U SVUBR/L 16	●	●	40	37.5	350	27	≥50					

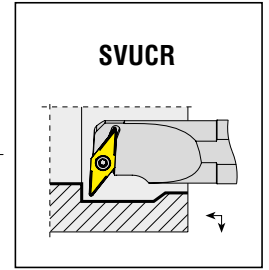
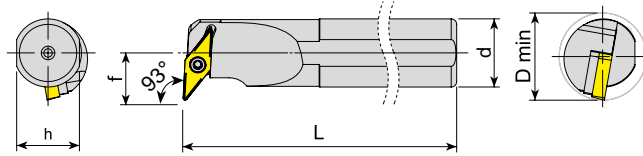

Takım Kodu Ordering Code	Stok Stock		Takım Ölçüleri (mm) Dimension (mm)					Kesici Uç Insert	Yedek Parçaları Spare Parts			
	R	L	d	h	L	f	D min		Sıkma Vidası Screw	Altık Shim	Altık Vidası Shim Screw	Tork Anahtar Torx Key
S16P SVUCR/L 11	●	●	16	14.8	170	12.5	≥20	VC.T 1103..	4008-M2.5x6	-	-	80-T08
S20R SVUCR/L 11	●	●	20	18.3	200	13	≥25					
S25S SVUCR/L 16	●	●	25	23	250	19	≥32	VC.T 1604..	4015-M3.5x14	AAVN-2-0002	AAV-06-M3.5x11	80-T15
S32T SVUCR/L 16	●	●	32	30	300	22	≥40					
S40U SVUCR/L 16	●	●	40	37.5	350	27	≥50					

R: Sağ/Right L: Sol/Left ● Stokta/In Stock ○ Stokta Yok/Non Stock Item

Sipariş Örneği/Ordering Example : 1 ad./pcs. S16P SVUBR 11

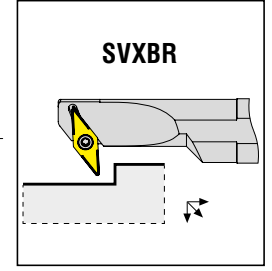
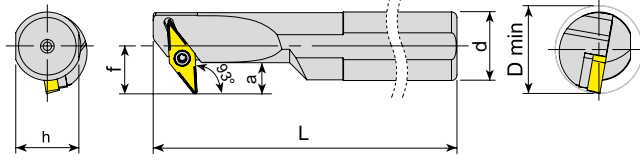

Takım Kodu Ordering Code	Stok Stock		Takım Ölçüleri (mm) Dimension (mm)					Kesici Uç Insert	Yedek Parçaları Spare Parts				
	R	L	d	h	L	f	a		D min	Sıkma Vidası Screw	Altlık Shim	Altlık Vidası Shim Screw	Tork Anahtar Torx Key
S16P SVXBR/L 1102	●	○	16	14.8	170	12.5	7.2	≥20	VBM. 1102..	4008-M2.5x6	-	-	80-T08
S20R SVXBR/L 1102	●	○	20	18.3	200	13	5.7	≥25					
S16P SVXBR/L 11	●	●	16	14.8	170	12.5	7.2	≥20	VBM. 1103..	-	-	80-T08	
S20R SVXBR/L 11	●	●	20	18.3	200	13	5.7	≥25					
S25S SVXBR/L 16	●	●	25	23	250	19	10.2	≥32	VBM. 1604..	4015-M3.5x14	AAVN-2-0002	AAV-06-M3.5x11	80-T15
S32T SVXBR/L 16	●	●	32	30	300	22	11.7	≥40					
S40U SVXBR/L 16	●	●	40	37.5	350	27	14.3	≥50					

Not: "a" ölçüleri R0.4'e göre verilmiştir.

Note: Dimensions of "a" are given according to R.04.

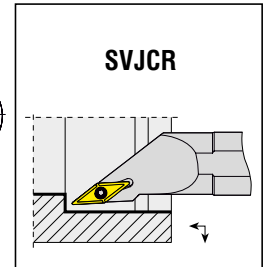
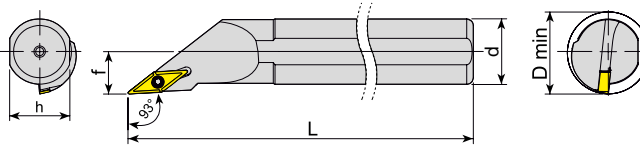

Takım Kodu Ordering Code	Stok Stock		Takım Ölçüleri (mm) Dimension (mm)					Kesici Uç Insert	Yedek Parçaları Spare Parts			
	R	L	d	h	L	f	D min		Sıkma Vidası Screw	Altlık Shim	Altlık Vidası Shim Screw	Tork Anahtar Torx Key
S12K SVJCR/L 11	●	●	12	11	125	7	13	VC.T 1103..	4008-M2.5x6	-	-	80-T08
S16P SVJCR/L 11	●	●	16	14.8	170	11	20					
S20R SVJCR/L 11	●	●	20	18.3	200	13	25					

R: Sağ/Right L: Sol/Left ● Stokta/In Stock ○ Stokta Yok/Non Stock Item

Sipariş Örneği/Ordering Example : 1 ad./pcs. S16P SVXBR 1102

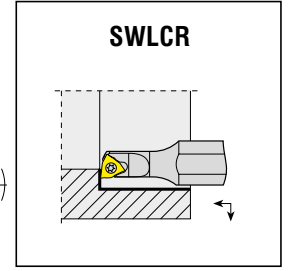
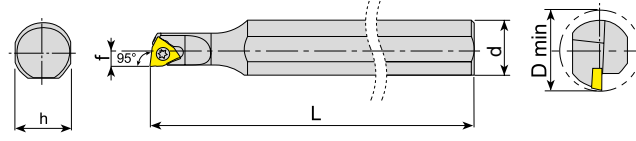

Takım Kodu Ordering Code	Stok Stock	Takım Ölçüleri (mm) Dimension (mm)					Kesici Uç Insert	Yedek Parçaları Spare Parts			
		d	h	L	f	D min		Sıkma Vidası Screw	Altık Shim	Altık Vidası Shim Screw	Tork Anahtar Torx Key
S0608H SWLCR 03	●	08	7.3	100	04	≥08	WC.. 0302..	4008-M2.5x4	-	-	80-T08
S0810K SWLCR 03	●	10	09	125	06	≥10					

R: Sağ/Right L: Sol/Left ● Stokta/In Stock ○ Stokta Yok/Non Stock Item

Sipariş Örneği/Ordering Example : 1 ad./pcs. S16P SVXBR 11

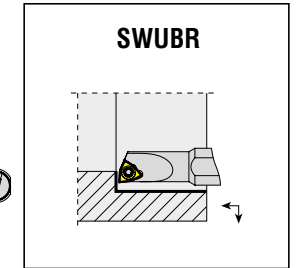
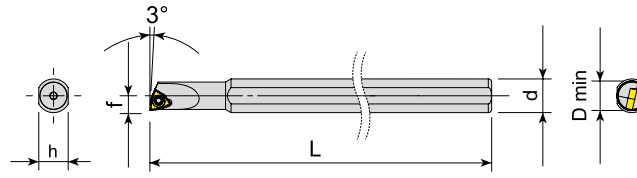

Takım Kodu Ordering Code	Stok Stock	Takım Ölçüleri (mm) Dimension (mm)					Kesici Uç Insert	Yedek Parçaları Spare Parts			
		d	h	L	f	D min		Sıkma Vidası Screw	Altık Shim	Altık Vidası Shim Screw	Tork Anahtar Torx Key
S08H SWUBR 06-5.5	●	08	7.3	100	2.75	≥5.5	WBGT 060102-L	3006-M2x3.6	-	-	80-T06
S08H SWUBR 06-7	●	08	7.3	100	3.5	≥7		3006-M2x4			

R: Sağ/Right L: Sol/Left ● Stokta/In Stock ○ Stokta Yok/Non Stock Item
KYCR Ucuna Uygundur. / Compatible with KYCR Insert.

Sipariş Örneği/Ordering Example : 1 ad./pcs. S0608H SWLCR 03

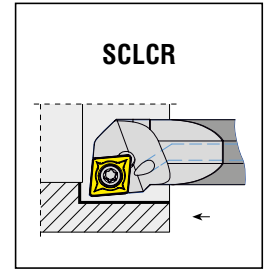
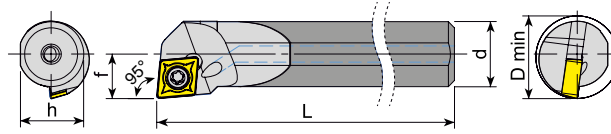

Takım Kodu Ordering Code	Stok Stock		Takım Ölçüleri (mm) Dimension (mm)				Kesici Uç Insert	Yedek Parçaları Spare Parts				
	R	L	d	h	L	f		D min	Sıkma Vidası Screw	Altık Shim	Altık Vidası Shim Screw	Anahtar Allen Key
E08K SCLCR/L 06	●	○	8	7.5	125	6	≥11	CC.T 0602..	4008-M2.5x6	-	-	80-T08
E10M SCLCR/L 06	●	○	10	9.5	150	7	≥13					
E12Q SCLCR/L 06	●	○	12	11	180	9	≥16	CC.T 09T3..	4015-M3.5x9	-	-	80-T15
E16R SCLCR/L 09	●	○	16	15	200	11	≥20					

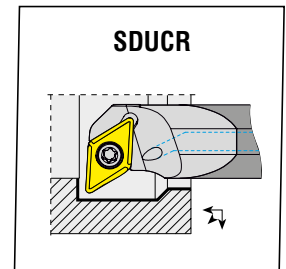
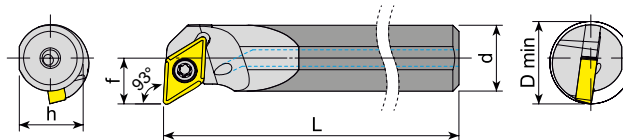

Takım Kodu Ordering Code	Stok Stock		Takım Ölçüleri (mm) Dimension (mm)				Kesici Uç Insert	Yedek Parçaları Spare Parts				
	R	L	d	h	L	f		D min	Sıkma Vidası Screw	Altık Shim	Altık Vidası Shim Screw	Anahtar Allen Key
E10M SDUCR/L 07	●	○	10	9.5	150	8	≥13	DC.T 0702..	4008-M2.5x6	-	-	80-T08
E12Q SDUCR/L 07	●	○	12	11	180	9	≥16					
E16R SDUCR/L 11	●	○	16	15	200	11	≥20	DC.T 11T3..	4015-M3.5x9	-	-	80-T15

R: Sağ/Right L: Sol/Left ● Stokta/In Stock ○ Stokta Yok/Non Stock Item

Sipariş Örneği/Ordering Example : 1 ad./pcs. E08K SCLCR 06

SET-A/SCLCR/L

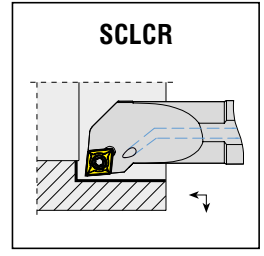
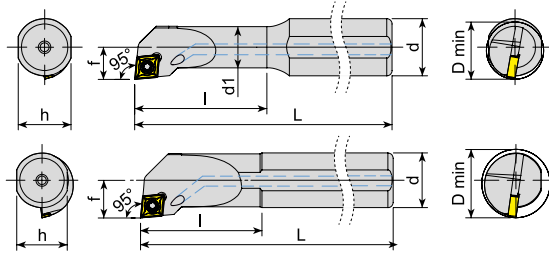

Takım Kodu
Ordering Code

Stok
Stock

Takım Ölçüleri (mm)
Dimension (mm)

Kesici Uç
Insert

Yedek Parçaları
Spare Parts

Sıkma Vidası
Screw

Altık
Shim

Altık Vidası
Shim Screw

Tork Anahtar
Torx Key

R L

d

d1

h

l

L

f

D min

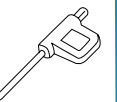
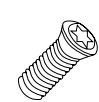

A08H SCLCR/L 06	●●	8	8	7.3	20	100	6	≥11	CC.T 0602..	4008-M2.5x6	-	-	80-T08
A10H SCLCR/L 06	●●	10	10	9	25	100	7	≥13					
A12H SCLCR/L 06	●●	12	12	11	25	100	9	≥16					
A16M SCLCR/L 09	●●	16	16	14.8	35	150	11	≥20					

SET-E/SCLCR/L

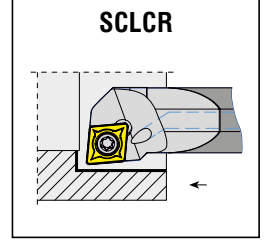
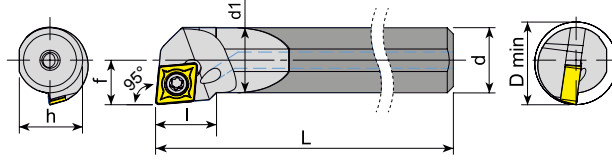

Takım Kodu
Ordering Code

Stok
Stock

Takım Ölçüleri (mm)
Dimension (mm)

Kesici Uç
Insert

Yedek Parçaları
Spare Parts

Sıkma Vidası
Screw

Altık
Shim

Altık Vidası
Shim Screw

Tork Anahtar
Torx Key

R L

d

d1

h

l

L

f

D min

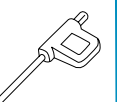
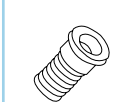
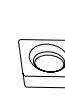
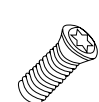

E08K SCLCR/L 06	●○	8	8	7.5	10	125	6	≥11	CC.T 0602..	4008-M2.5x6	-	-	80-T08
E10M SCLCR/L 06	●○	10	10	9.5	10	150	7	≥13					
E12Q SCLCR/L 06	●○	12	12	11	12	180	9	≥16					
E16R SCLCR/L 09	●○	16	16	15	15	200	11	≥20					

SET-S/SCLCR/L

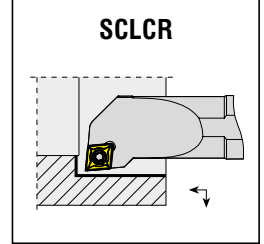
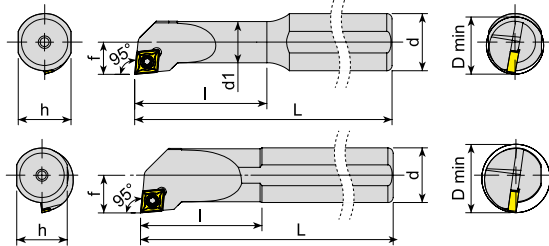

Takım Kodu
Ordering Code

Stok
Stock

Takım Ölçüleri (mm)
Dimension (mm)

Kesici Uç
Insert

Yedek Parçaları
Spare Parts

Sıkma Vidası
Screw

Altık
Shim

Altık Vidası
Shim Screw

Tork Anahtar
Torx Key

R L

d

d1

h

l

L

f

D min

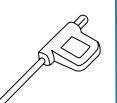
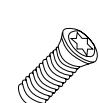

S08H SCLCR/L 06	●●	8	8	7.3	20	100	6	≥11	CC.T 0602..	4008-M2.5x6	-	-	80-T08
S10K SCLCR/L 06	●●	10	10	9	25	125	7	≥13					
S12K SCLCR/L 06	●●	12	12	11	25	125	9	≥16					
S16P SCLCR/L 09	●●	16	16	14.8	35	170	11	≥20					

R: Sağ/Right L: Sol/Left ● Stokta/In Stock ○ Stokta Yok/Non Stock Item

Sipariş Örneği/Ordering Example : 1 ad./pcs. SET-A/SCLCR

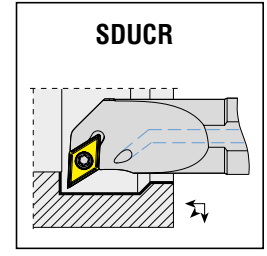
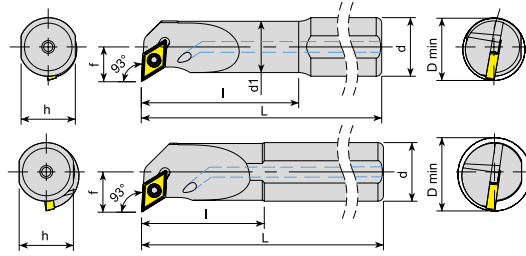

Takım Kodu Ordering Code	Stok Stock	Takım Ölçüleri (mm) Dimension (mm)								Kesici Uç Insert	Yedek Parçaları Spare Parts						
		R	L	d	d1	h	l	L	f		D min	Sıkma Vidası Screw	Altlık Shim	Altlık Vidası Shim Screw	Tork Anahtar Torx Key		
A10H SDUCR/L 07	●●	10	10	09	25	100	08	≥13	DC.T 0702..		4008-M2.5x6						
A12H SDUCR/L 07	●●	12	12	11	25	100	09	≥16							-	-	80-T08
A16M SDUCR/L 11	●●	16	16	14.8	35	150	11	≥20							DC.T 11T3..	4015-M3.5x9	-

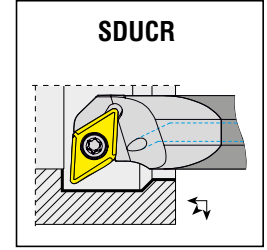
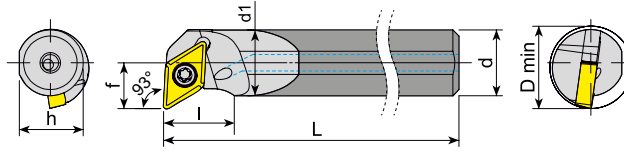

Takım Kodu Ordering Code	Stok Stock	Takım Ölçüleri (mm) Dimension (mm)								Kesici Uç Insert	Yedek Parçaları Spare Parts						
		R	L	d	d1	h	l	L	f		D min	Sıkma Vidası Screw	Altlık Shim	Altlık Vidası Shim Screw	Tork Anahtar Torx Key		
E10M SDUCR/L 07	●○	10	10	9.5	09	150	8	≥13	DC.T 0702..		4008-M2.5x6						
E12Q SDUCR/L 07	●○	12	12	11	10	180	9	≥16							-	-	80-T08
E16R SDUCR/L 11	●○	16	16	15	12	200	11	≥20							DC.T 11T3..	4015-M3.5x9	-

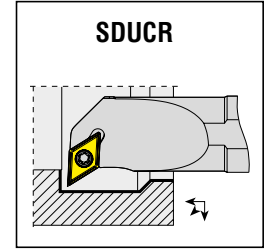
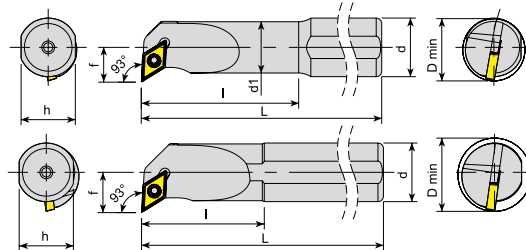

Takım Kodu Ordering Code	Stok Stock	Takım Ölçüleri (mm) Dimension (mm)								Kesici Uç Insert	Yedek Parçaları Spare Parts						
		R	L	d	d1	h	l	L	f		D min	Sıkma Vidası Screw	Altlık Shim	Altlık Vidası Shim Screw	Tork Anahtar Torx Key		
S10K SDUCR/L 07	●●	10	10	9	25	125	8	≥13	DC.T 0702..		4008-M2.5x6						
S12K SDUCR/L 07	●●	12	12	11	25	125	9	≥16							-	-	80-T08
S16P SDUCR/L 11	●●	16	16	14.8	35	170	11	≥20							DC.T 11T3..	4015-M3.5x9	-

R: Sağ/Right L: Sol/Left ● Stokta/In Stock ○ Stokta Yok/Non Stock Item

Sipariş Örneği/Ordering Example : 1 ad./pcs. SET-A/SDUCR



konusulan
the spoken kalite...
quality...

KARTUŞLAR

KARTUŞLAR
CARTRIDGE



www.akkо.com.tr

Дистрибьютер ООО "Ресурс Плюс"
+7 (351) 247-74-40; info@rp-ural.ru



S

1

T

2

F

3

C

4

R

5

12

6

C

7

A

8

16

9

1 Sıkma Tipi / Method of Mounting of Insert

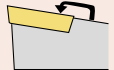

Deliksiz Üstten Sıkma
Top clamping without hole

C

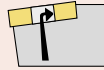

Delikten Laveyle Sıkma
Hole Clamping (Lever Lock)

P

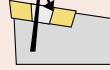

Vida ile Sıkma
Screw on

S

2 Uç Tipi / Insert Shape



C



S



T

3 Yanaşma Açısı / ToolHolder Shape

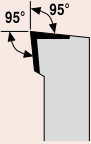

L

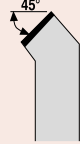

S



F

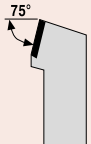

R



K

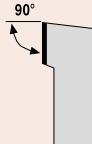

G

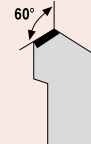

W

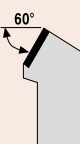

T

4 Serbest Uç Açısı / Clearance angle of Insert



C



P



N

5 Kesme Yönü / Cutting Direction

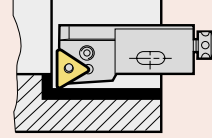

R

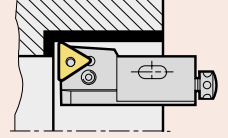

L

6 Kesme Kenar Yüksekliği / Cutting Edge Height

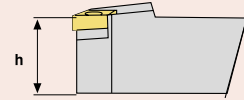

7 Kartuş Kodu / Cartridge Code

C
(Kartuş / Cartridge)

8 Kartuş Tipi / Type of Cartridge

A
(ISO 5611)

9 Kesme Kenar Uzunluğu / Cutting Edge Length

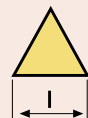
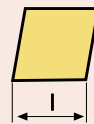

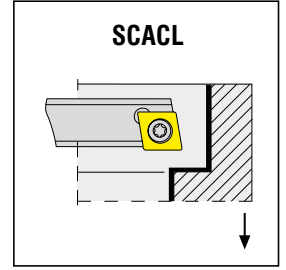
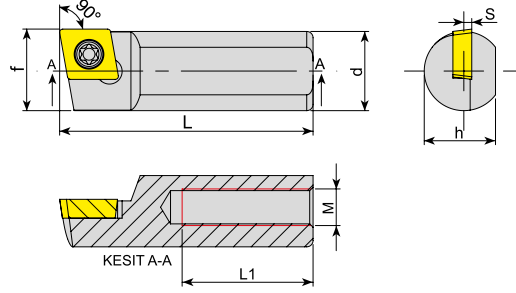

Takım Kodu Ordering Code	Stok Stock		Takım Ölçüleri (mm) Dimension (mm)							Kesici Uç Insert	Yedek Parçaları Spare Parts	
	R	L	d	h	L	L1	S	f	M		Sıkma Vidası Screw	Tork Anahtar Torx Key
S10X SCACR/L 06	●	●	10	9	25	10	1	10.3	M5x0.8	CC.. 0602..	4008-M2.5x6	80-T08
S10A SCACR/L 06	●	●	10	9	32	15	1	10.3	M5x0.8			
S10C SCACR/L 06	●	●	10	9	50	25	1	10.3	M5x0.8			
S12B SCACR/L 06	●	●	12	11	40	25	1	12.3	M5x0.8			
S12D SCACR/L 06	●	●	12	11	60	25	1	12.3	M5x0.8			
S12D SCACR/L 09	●	●	12	11	60	25	2	12.2	M5x0.8	CC.. 09T3..	4015-M3.5x8	80-T15
S12H SCACR/L 09	●	●	12	11	100	25	2	12.2	M5x0.8			
S15C SCACR/L 09	○	●	15	14	50	25	2	15.3	M8x1.25			
S1554 SCACR/L 09	○	●	15	14	54	25	2	15.3	M8x1.25			
S15E SCACR/L 09	○	●	15	14	70	45	2	15.3	M8x1.25			
S15D SCACR/L 09	○	●	15	14	60	30	2	15.3	M8x1.25			
S16A SCACR/L 09	●	●	16	15	32	15	2	16.5	M6x1			
S16B SCACR/L 09	●	●	16	15	40	20	2	16.5	M6x1			
S16C SCACR/L 09	○	●	16	15	50	25	2	16.5	M6x1			
S16D SCACR/L 09	●	●	16	15	60	30	2	16.5	M6x1			
S16E SCACR/L 09	○	●	16	15	70	30	2	16.5	M6x1			
S16G SCACR/L 09	●	●	16	15	90	30	2	16.5	M6x1			
S16H SCACR/L 09	○	●	16	15	100	35	4	16.5	M6x1			
S1868 SCACR/L 09	○	●	18	17	68	30	2	18.5	M8x1.25			
S18E SCACR/L 09	○	●	18	17	70	30	2	18.5	M8x1.25			
S1888 SCACR/L 09	○	●	18	17	88	30	2	18.5	M8x1.25			
S18105 SCACR/L 09	○	●	18	17	105	30	2	18.5	M8x1.25			
S18175 SCACR/L 09	○	●	18	17	175	30	2	18.5	M8x1.25			
S20E SCACR/L 09	●	●	20	18.3	70	30	2	20.5	M6x1	CC.. 1204..	1020-M5x11	80-T20
S20E SCACR/L 12	●	●	20	18.3	70	30	2	20.5	M6x1			
S20H SCACR/L 12	●	●	20	18.3	100	30	2	20.5	M6x1			

R: Sağ/Right L: Sol/Left ● Stokta/In Stock ○ Stokta Yok/Non Stock Item

Sipariş Örneği/Ordering Example : 1 ad./pcs. S10X SCACR 06

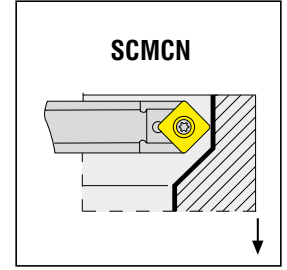
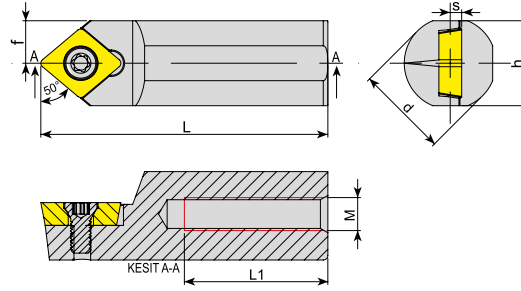

Takım Kodu Ordering Code	Stok Stock	Takım Ölçüleri (mm) Dimension (mm)						Kesici Uç Insert	Yedek Parçaları Spare Parts		
		d	h	L	L1	S	f		M	Sıkma Vidası Screw	Tork Anahtar Torx Key
S10X SCMCN 06	●	10	9	25	10	1	5	M5x0.8		4008-M2.5x6	80-T08
S16C SCMCN 09	●	16	15	50	25	2	8	M6x1		4015-M3.5x11	80-T15
S16D SCMCN 09	●	16	15	60	25	4	8	M6x1		4015-M3.5x11	80-T15

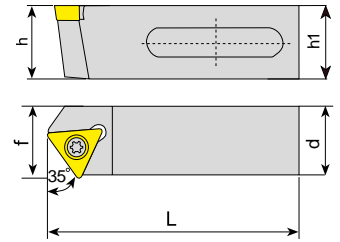

Takım Kodu Ordering Code	Stok Stock		Takım Ölçüleri (mm) Dimension (mm)					Kesici Uç Insert	Yedek Parçaları Spare Parts	
	R	L	d	h	h1	L	f		Sıkma Vidası Screw	Tork Anahtar Torx Key
STXCR/L 2020 B16	○	●	20	20	20	45	20			
STXCR/L 2020 E16	○	●	20	20	20	70	20			
STXCR/L 2020 B16-SA	○	●	20	10	20	45	20			
STXCR/L 2020 E16-SA	○	●	20	10	20	70	20			
STXCR/L 2020 B16-PL	○	●	20	10	20	45	20			
STXCR/L 2020 E16-PL	○	●	20	10	20	70	20			
STXCR/L 2020 H16-PL	○	●	20	10	20	100	20			
								TC.. 16T3..	4015-M3.5x11	80-T15

R: Sağ/Right L: Sol/Left ● Stokta/In Stock ○ Stokta Yok/Non Stock Item

Sipariş Örneği/Ordering Example : 1 ad./pcs. S10X SCMCN 06

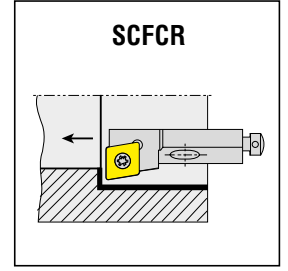
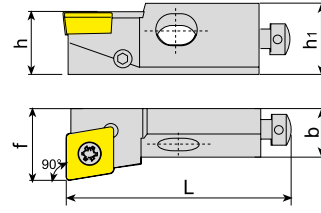
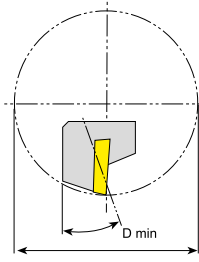

Takım Kodu Ordering Code	Stok Stock		Takım Ölçüleri (mm) Dimension (mm)					Kesici Uç Insert	Yedek Parçaları Spare Parts				
	R	L	h	h1	b	L	f		D min	Altık Shim	Altık Vidası Shim Screw	Sıkma Vidası Screw	Tork Anahtar Torx Key
SCFCR/L 06CA 06	●	●	6	8.5	6	25	8	≥20	CC.T 060204	-	-	4008-M2.5x6	80-T08
SCFCR/L 08CA 06	●	●	8	11	8	32	10	≥25		-	-	4015-M3.5x11	80-T15
SCFCR/L 10CA 09	●	●	10	15	11	50	14	≥40		-	-	4020-M4.5x12	80-T20
SCFCR/L 12CA 12	●	○	12	20	15	55	20	≥50		AACN-2-0003	AAV-10-M4.5x8		
SCFCR/L 16CA 12	●	●	16	21	20	63	25	≥60					

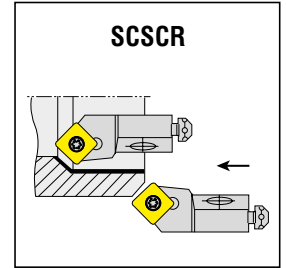
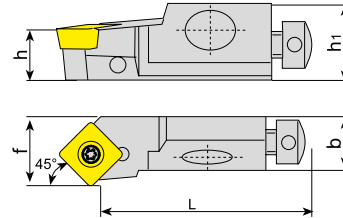
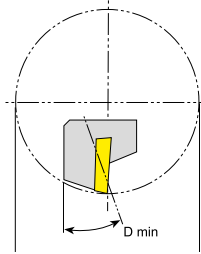

Takım Kodu Ordering Code	Stok Stock		Takım Ölçüleri (mm) Dimension (mm)					Kesici Uç Insert	Yedek Parçaları Spare Parts				
	R	L	h	h1	b	L	f		D min	Altık Shim	Altık Vidası Shim Screw	Sıkma Vidası Screw	Tork Anahtar Torx Key
SCSCR/L 06CA 06	○	○	6	8	6	21	8	≥20	CC.T 060204	-	-	4008-M2.5x6	80-T08
SCSCR/L 10CA 09	●	○	10	15	11	44	14	≥40		-	-	4015-M3.5x14	80-T15
SCSCR/L 12CA 12	○	○	12	20	15	47	20	≥50		-	-	1020-M4.5x16	80-T20

R: Sağ/Right L: Sol/Left ● Stokta/In Stock ○ Stokta Yok/Non Stock Item

Sipariş Örneği/Ordering Example : 1 ad./pcs. SCFCR 06CA 06

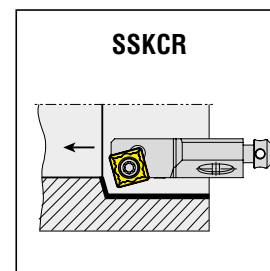
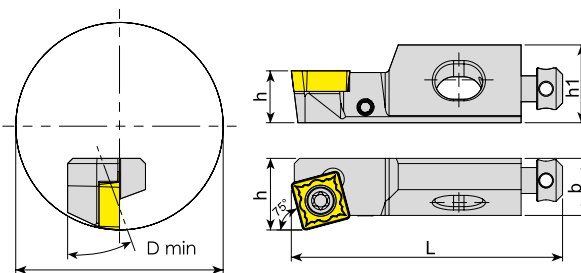

Takım Kodu Ordering Code	Stok Stock		Takım Ölçüleri (mm) Dimension (mm)						Kesici Uç Insert	Yedek Parçaları Spare Parts			
	R	L	h	h1	b	L	f	D min		Altık Shim	Altık Vidası Shim Screw	Sıkma Vidası Screw	Tork Anahtar Torx Key
SSKCR/L 10CA 09	●	○	10	15	11	40	14	≥40		-	-	4015-M3.5x11	80-T15

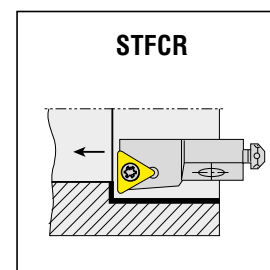
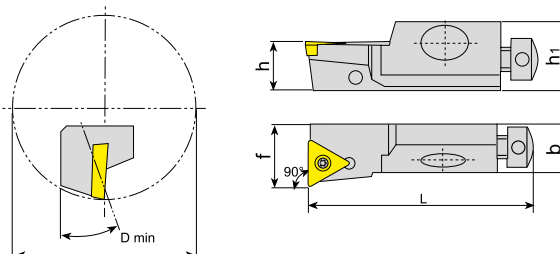

Takım Kodu Ordering Code	Stok Stock		Takım Ölçüleri (mm) Dimension (mm)						Kesici Uç Insert	Yedek Parçaları Spare Parts			
	R	L	h	h1	b	L	f	D min		Altık Shim	Altık Vidası Shim Screw	Sıkma Vidası Screw	Tork Anahtar Torx Key
STFRCR/L 08CA 09	●	○	8	11	8	32	10	≥25		-	-	3007-M2.2x5	80-T07
STFRCR/L 10CA 11	●	●	10	15	11	50	14	≥40		-	-	4008-M2.5x6	80-T08
STFRCR/L 12CA 16	●	○	12	20	15	47	20	≥50		-	-	4015-M3.5x11	80-T15
STFRCR/L 16CA 16	●	●	16	21	20	63	25	≥60		AATN-2-0001	AAV-06-M3.5x11	4015-M3.5x14	80-T15

R: Sağ/Right L: Sol/Left ● Stokta/In Stock ○ Stokta Yok/Non Stock Item

Sipariş Örneği/Ordering Example : 1 ad./pcs. SSKCR 10CA 09

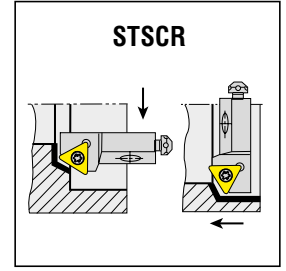
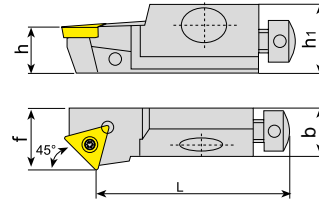
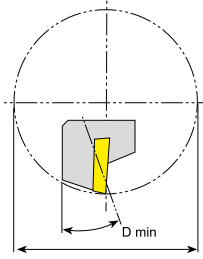

Takım Kodu Ordering Code	Stok Stock		Takım Ölçüleri (mm) Dimension (mm)						Kesici Uç Insert	Yedek Parçaları Spare Parts			
	R	L	h	h1	b	L	f	D min		Altık Shim	Altık Vidası Shim Screw	Sıkma Vidası Screw	Tork Anahtar Torx Key
STSCR/L 08CA 09	●	○	8	11	8	28	10	≥25	TC.T 090204	-	-	3007-M2.2x5	80-T07
STSCR/L 10CA 11	●	●	10	15	11	44	14	≥40	TC.T 110204	-	-	4008-M2.5x6	80-T08
STSCR/L 12CA 16	●	○	12	20	15	47	20	≥50	TC.T 16T308	-	-	4015-M3.5x11	80-T15

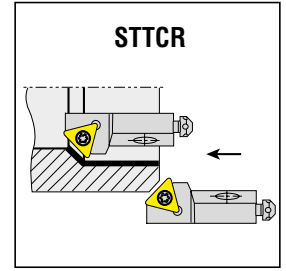
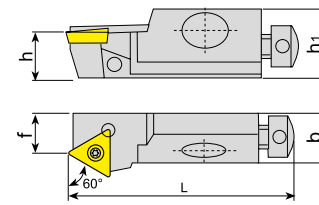
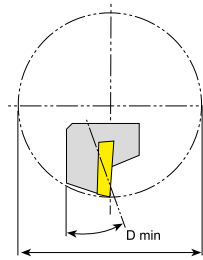

Takım Kodu Ordering Code	Stok Stock		Takım Ölçüleri (mm) Dimension (mm)						Kesici Uç Insert	Yedek Parçaları Spare Parts			
	R	L	h	h1	b	L	f	D min		Altık Shim	Altık Vidası Shim Screw	Sıkma Vidası Screw	Tork Anahtar Torx Key
STTCR/L 08CA 09	●	○	8	11	8	32	6	≥25	TC.T 090204	-	-	3007-M2.2x5	80-T07
STTCR/L 10CA 11	●	○	10	15	11	50	9	≥40	TC.T 110204	-	-	4008-M2.5x6	80-T08

R: Sağ/Right L: Sol/Left ● Stokta/In Stock ○ Stokta Yok/Non Stock Item

Sipariş Örneği/Ordering Example : 1 ad./pcs. STSCR 08CA 09



75°

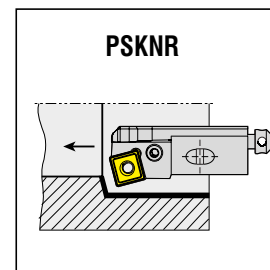
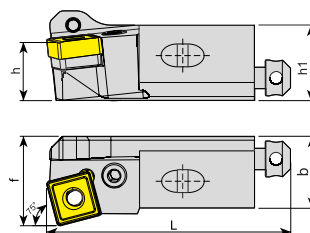
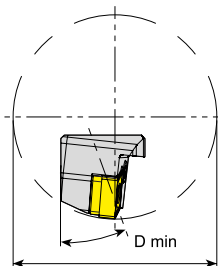

Takım Kodu Ordering Code	Stok Stock		Takım Ölçüleri (mm) Dimension (mm)						Kesici Uç Insert	Yedek Parçaları Spare Parts					
	R	L	h	h1	b	L	f	D min		Levye Lever	Levye Vidası Lever Screw	Altlık Shim	Altlık Yayı Shim Spring	Anahtar Allen Key	
	●	○													
PSKNR/L 16CA 12	●	○	16	21	20	55	25	≥60		SNM.120408	APL-02	ALV-03-M8x19	AASN-3-0004	AAAY-02	AAL-03-3



90°

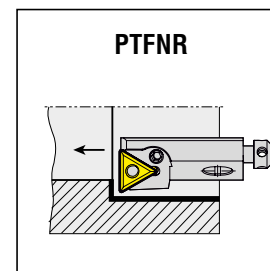
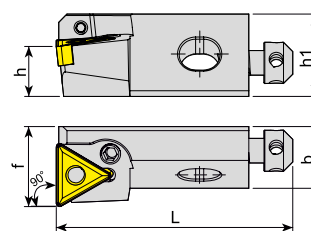
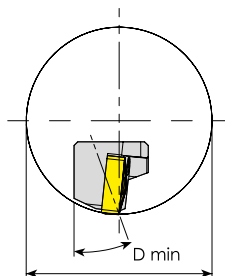

Takım Kodu Ordering Code	Stok Stock		Takım Ölçüleri (mm) Dimension (mm)						Kesici Uç Insert	Yedek Parçaları Spare Parts					
	R	L	h	h1	b	L	f	D min		Levye Lever	Levye Vidası Lever Screw	Altlık Shim	Altlık Yayı Shim Spring	Anahtar Allen Key	
	●	○													
PTFNR/L 12CA 16	●	○	12	20	15	47	20	≥50		TNM.160408	APL-01	ALV-02-M6x17	-	-	AAL-03-3

R: Sağ/Right L: Sol/Left ● Stokta/In Stock ○ Stokta Yok/Non Stock Item

Sipariş Örneği/Ordering Example : 1 ad./pcs. PSKNR 16CA 12

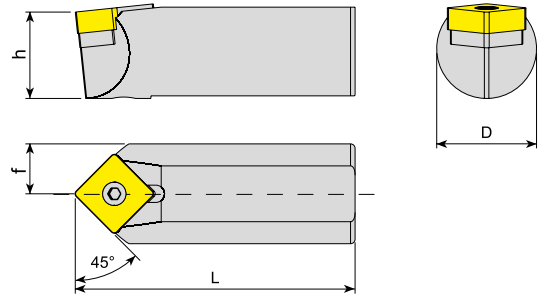

Takım Kodu Ordering Code	Stok Stock	Takım Ölçüleri (mm) Dimension (mm)				Kesici Uç Insert	Yedek Parçaları Spare Parts				
		d	h	L	f		Altık Shim	Sıkma Vidası Clamp Screw	Baskı Parçası Wedge Clamp	Baskı Vidası Clamp Screw	Anahtar Allen Key
S22D PSDNN 12C	●	22	19.5	60	11						

R: Sağ/Right L: Sol/Left ● Stokta/In Stock ○ Stokta Yok/Non Stock Item

Sipariş Örneği/Ordering Example : 1 ad./pcs. S22D PSDNN 12C

KARTUŞLARIN YEDEK PARÇALARI
SPARE PARTS OF CARTRIDGE

Takım Kodu Ordering Code	Yedek Parçaları Spare Parts					
	Eksenel Ayar Vida Axial Adj. Screw	Radyal Ayar Vida Radial Adj. Screw	Radyal Ayar Vida Anahtar Radial Adj. Screw Allen Key	Montaj Vida Mounting Screw	Montaj Vida Anahtar Mounting Screw Allen Key	
SCFCR/L	06CA 06	2600-M4x9.5	2715-M3x5	AAL-09-1.5	AKV-23-M4x10	AAL-03-3
SCSCR/L	08CA 06	2600-M4x9.5	2715-M3x5	AAL-09-1.5	AKV-23-M4x10	AAL-03-3
	10CA 09	2600-M5x13	2702-M4x10	AAL-01-2	AKV-02-M6x22	AAL-07-5
	12CA 12	2600-M5x13	2702-M4x10	AAL-01-2	AKV-02-M6x22	AAL-07-5
	16CA 12	2600-M6x18	2725-M5x12	AAL-02-2.5	2005-M8x25	AAL-08-6
STSCR/L	08CA 09	2600-M4x9.5	2715-M3x5	AAL-09-1.5	AKV-23-M4x10	AAL-03-3
STTCR/L	10CA 11	2600-M5x13	2702-M4x10	AAL-01-2	AKV-02-M6x22	AAL-07-5
STFCR/L	12CA 16	2600-M5x13	2702-M4x10	AAL-01-2	AKV-02-M6x22	AAL-07-5
	16CA 16	2600-M6x18	2725-M5x12	AAL-02-2.5	2005-M8x25	AAL-08-6



Takım Kodu Ordering Code	Stok Stock	Ölçü Aralığı (mm) Boring Range (mm)					Kartuşlar Cartridge	Gövde Takım Kodu Body Tool Code	Teknik Çizim Technical Draw
		D max		D min		Max (D dış-D iç) (D out-D in)			
		D iç D in	D dış D out	D iç D in	D dış D out				
ACPBT-1	●	27-52	52	18-36	36	27	ÖTG-K-120-20		
ACPBT-2	●	27-49	52	25-36	36	27			
ACPBT-3	●	48-75	75	41	42	27			
ACPBT-4	●	51-75	75	51	52	27			
ACPBT-5	●	22-35	35	22	23	27			
ACPBT-6	●	15-35	35	15	16	27			
ACPBT-7	●	49-53	75	32-36	36	27			
ACPBT-8	●	49	75	33-37	37	27			

Takım Kodu Ordering Code	Stok Stock	Ölçü Aralığı (mm) Boring Range (mm)					Kartuşlar Cartridge	Gövde Takım Kodu Body Tool Code	Teknik Çizim Technical Draw
		D1		D2		Max (D dış-D iç) (D out-D in)			
		D max	D min	D max	D min				
ACPBT-9	●	38	24	15	1	-	ÖTG-K-120-20		
ACPBT-10	●	78	64	43	29	-			

R: Sağ/Right L: Sol/Left ● Stokta/In Stock ○ Stokta Yok/Non Stock Item

Sipariş Örneği/Ordering Example : 1 ad./pcs. ACPBT-1



*konusulan
the spoken kalite...
quality...*

DİŞ AÇMA

DİŞ AÇMA TAKIMLARI
THREADING TOOLHOLDERS



www.akkо.com.tr

Дистрибьютер ООО "Ресурс Плюс"
+7 (351) 247-74-40; info@rp-ural.ru



S **E** **R** **25 25** **M** **16** **C**

1 Sıkma Tipi
Method of Mounting of Insert

S: Vida Sıkmalı
S: Screw Clamping
T: Vida Sıkmalı Helis Açılı
T: Screw Clamping with Helix Angle

2 İşlem Tipi
Application

E: Dış / External
I: İç / Internal

3 Kesme Yönü
Cutting Direction

R: Sağ Yan / Right - Hand
L: Sol Yan / Left - Hand

4 Takım Malzemesi / Type of Boring Bar

"A" Yekpare çelik gövde soğutma suyu kanallı / "A" Solid steel with coolant hole
 "E" Çelik başlıkla sert metal gövde ve soğutma suyu kanallı /
 "E" Carbide bar with fixed steel head and coolant hole
 "C" Karbür Şaft / "C" Carbide shank
 "S" Çelik Şaft / "S" Steel shank

4-5 Dış Çap Şaft Ölçüleri
External Shank Size

Şaft : hxb / Shank : hxb
2525 - 25 x 25 mm

5 Şaft Çapı / Shank Diameter

6 Şaft Boyu / Shank Length

A - 32	H - 100	Q - 180	x-special
B - 40	J - 110	R - 200	
C - 50	K - 125	S - 250	
D - 60	L - 140	T - 300	
E - 70	M - 150	U - 350	
F - 80	N - 160	V - 400	
G - 90	P - 170	W - 450	

7 Elmas Ölçüsü
Insert Size

l (mm)	d
06	5/32"
08	3/16"
11	1/4"
16	3/8"
22	1/2"
27	5/8"

8 Baskı Pabucu
Wedge Clamp

S **I** **R** **S** **25** **R** **16** **C**

DIŞ ÇAP DIŞ AÇMA KATERLERİ
EXTERNAL THREADING TOOLHOLDERS

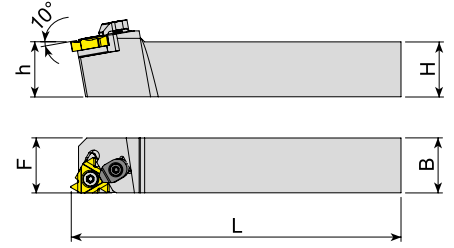
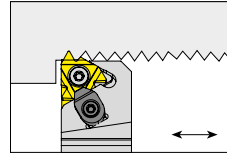

Takım Kodu Ordering Code	Stok Stock		Takım Ölçüleri (mm) Dimension (mm)				Kesici Uç Insert	Yedek Parçaları Spare Parts					
	R	L	h=H	B	L	F		Sıkma Vidası Screw	Altık Shim	Altık Vidası Shim Screw	Baskı Parçası Wedge Clamp	Baskı Vidası Clamp Screw	Tork Anahtar Torx Key
SER/L 0808 E11	●	●	08	08	70	11	11 ER/EL	4008-M2.5x6	-	-	-	-	80-T08
SER/L 1010 E11	●	●	10	10	70	11							
SER/L 1212 F11	●	●	12	12	80	12							
SER/L 1616 H11	●	●	16	16	100	16	16 ER/EL (0.35 - 3) ISO METRIC	4015-M3.5x14	AATN-2-0020	AAV-06-M3.5x11	-	-	80-T15
SER/L 1616 H16C	●	●	16	16	100	16							
SER/L 2020 K16C	●	●	20	20	125	20							
SER/L 2525 M16C	●	●	25	25	150	25	22 ER/EL (3.5 - 4.5) ISO METRIC	1020-M4.5x16	AATN-2-0004	AAV-07-M4.5x13	ACK-05	1515 M4x11	80-T20
SER/L 3232 P16C	●	●	32	32	170	32							
SER/L 2525 M22C	●	●	25	25	150	25							
SER/L 3232 P22C	●	●	32	32	170	32	16 ER/L (1.5-3 TR)	4015-M3.5x14	-	-	-	-	80-T15
SER/L 4040 S22C	●	●	40	40	250	40							
SER/L 2525 M16C-T	●	●	25	25	150	25							
SER/L 2020 K16C-S	●	●	20	20	125	25	22 ER/L (4-6 TR)	1020-M4.5x16	-	-	-	-	80-T20
SER/L 2525 M16C-S	●	●	25	25	150	31							
SER/L 3232 P16C-S	●	●	32	32	170	38.5							
SER/L 2525 M16C-S	●	●	25	25	150	31	SNDVK 166 ER/L16	4015-M3.5x14	AATN-2-0020	AAV-06-M3.5x11	-	-	80-T15

DIŞ ÇAP DIŞ AÇMA İSVİÇRE TİPİ KAYAR OTOMAT MAKİNA KATERLERİ
EXTERNAL THREADING TOOLHOLDERS FOR SWISS TYPE SLIDING AUTOMATIC LATHES

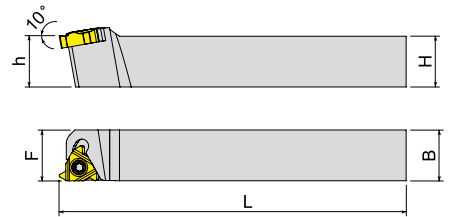
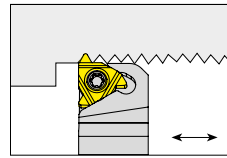

Takım Kodu Ordering Code	Stok Stock		Takım Ölçüleri (mm) Dimension (mm)				Kesici Uç Insert	Yedek Parçaları Spare Parts					
	R	L	h=H	B	L	F		Sıkma Vidası Screw	Altık Shim	Altık Vidası Shim Screw	Baskı Parçası Wedge Clamp	Baskı Vidası Clamp Screw	Tork Anahtar Torx Key
SER/L 1010 K11-S	●	●	10	10	125	10	11 ER/EL	4008-M2.5x6	-	-	-	-	80-T08
SER/L 1212 K11-S	●	●	12	12	125	12							

R: Sağ/Right L: Sol/Left ● Stokta/In Stock ○ Stokta Yok/Non Stock Item / Takımlar standart 1.5° helis açılı olarak üretilir. / The tools have a built in 1.5° helix angle.
UYARI / WARNING : Sayfa 106'deki B ve D figürleri uygulanamaz. / The operation for B and D on page 106 can not be applied.

Sipariş Örneği/Ordering Example : 1 ad./pcs. SER 0808 E11



www.akkocom.tr

Дистрибьютер ООО "Ресурс Плюс"
+7 (351) 247-74-40; info@rp-ural.ru

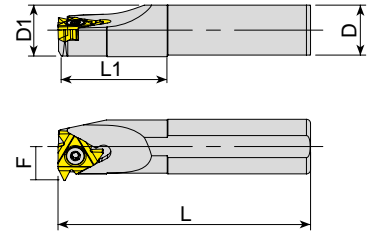
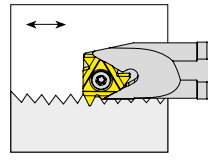

Takım Kodu Ordering Code	Stok Stock		Takım Ölçüleri (mm) Dimension (mm)					Kesici Uç Insert	Yedek Parçaları Spare Parts						
	R	L	D	D1	L	L1	F		D min	Sıkma Vidası Screw	Aftlık Shim	Aftlık Vidası Shim Screw	Baskı Parçası Wedge Clamp	Baskı Vidası Clamp Screw	Tork Anahtar Torx Key
SIR/L S12X05H 06	●	○	12	05	100	15	4.3	6.4	06 IR/L	3006-M2x4	-	-	-	-	80-T06
SIR/L S16X07M 08	●	●	16	07	150	18	5.3	7.8	08 IR/L	3007-M2.2x5	-	-	-	-	80-T07
SIR/L S10H 11	●	●	10	10	100	-	7.4	12	11 IR/L	4008-M2.5x6	-	-	-	-	80-T08
SIR/L S12K 11	●	●	12	12	125	-	8.4	16							
SIR/L S16X10M 11	●	●	16	10	150	25	7.4	12							
SIR/L S16X13M 11	●	●	16	13	150	32	8.9	15							
SIR/L S16M 11	●	●	16	16	150	-	11.7	19	16 IR/L (0.35 - 3) ISO METRIC	4015-M3.5x9	-	-	-	-	80-T15
SIR/L S16X13M 16	●	●	16	13	150	32	10.2	16		4015-M3.5x11					
SIR/L S16M 16	●	●	16	16	150	-	11.7	19							
SIR/L S20X16P 16	●	●	20	16	170	40	11.7	19							
SIR/L S20P 16	●	●	20	20	170	-	13.7	24							
SIR/L S25R 16C	●	●	25	25	200	-	16.2	29		4015-M3.5x14					
SIR/L S32S 16C	●	●	32	32	250	-	19.7	36	16 IR/L (1.5-3 TR)	4015-M3.5x14	AATN-2-0020	AAV-06-M3.5x11	ACK-05	1515-M4x11	80-T20
SIR/L S40T 16C	●	●	40	40	300	-	23.7	44							
SIR/L S50U 16C	●	●	50	50	350	-	28.7	54							
SIR/L S20P 22	●	●	20	20	170	-	14	24		4020-M4.5x12	-	-	-	-	
SIR/L S25R 22C	●	●	25	25	200	-	18.1	29	22 IR/L (3.5 - 4.5) ISO METRIC			AAV-10-M4.5x8			80-T20
SIR/L S32S 22C	●	●	32	32	250	-	21.6	38							
SIR/L S40T 22C	●	●	40	40	300	-	25.6	46	1020-M4.5x16	AATN-2-0004	AAV-07-M4.5x13	ACK-05	1515-M4x11	80-T15	
SIR/L S50U 22C	●	●	50	50	350	-	30.6	58							
SIR/L S25R 16C-T	●	●	25	25	200	-	16.2	29	16 IR/L (1.5-3 TR)	4015-M3.5x14	-	-			80-T15
SIR/L S32S 16C-T	●	●	32	32	250	-	19.7	36							
SIR/L S25R 22C-T	●	●	25	25	200	-	18.1	29	22 IR/L (4-6 TR)	1020-M4.5x16	-	-			80-T20
SIR/L S32S 22C-T	●	●	32	32	250	-	21.6	38							

R: Sağ/Right L: Sol/Left ● Stokta/In Stock ○ Stokta Yok/Non Stock Item

Takımlar standart 1.5° helis açılı olarak üretilir. / The tools have a built in 1.5° helix angle.

UYARI / WARNING

Sayfa 107'deki B ve D figürleri uygulanamaz. / The operation for B and D on page 107 can not be applied.

Sipariş Örneği/Ordering Example : 1 ad./pcs. SIR S12X05H 06

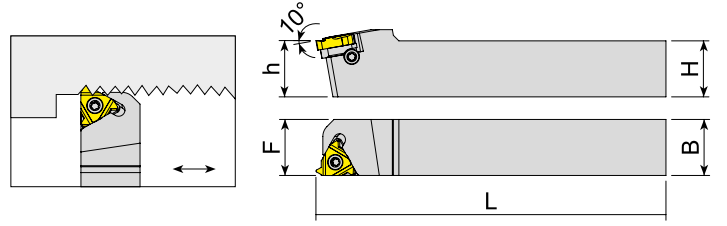

Takım Kodu Ordering Code	Stok Stock		Takım Ölçüleri (mm) Dimension (mm)				Kesici Uç Insert	Yedek Parçaları Spare Parts						
	R	L	h=H	B	L	F		Sıkma Vidası Screw	Sağ Altlık Right Shim	Sol Altlık Left Shim	Altık Vidası Shim Screw	Baskı Parçası Wedge Clamp	Baskı Vidası Clamp Screw	Tork Anahtar Torx Key
TER/L 1616 H16	●	●	16	16	100	16	16 ER/EL	1710-U5-40x12.2	ATS-16E	ATS-16I	AAV-11-U5-40x4.5	-	-	80-T10
TER/L 2020 K16	●	●	20	20	125	20								
TER/L 2525 M16	●	●	25	25	150	25								
TER/L 3232 P16	●	●	32	32	170	32								
TER/L 2525 M22	●	●	25	25	150	25	22 ER/EL	1720-U8-32x15	ATS-22E	ATS-22I	AAV-12-U8-32x5.5	-	-	80-T20
TER/L 3232 P22	●	●	32	32	170	32								
TER/L 4040 S22	●	●	40	40	250	40								
TER/L 2525 M27	●	●	25	25	150	25	27 ER/EL	1620-M5x22	ATS-27E	ATS-27I	AAV-15-M5x5.7	-	-	80-T20
TER/L 3232 P27	●	●	32	32	170	32								
TER/L 4040 S27	●	●	40	40	250	40								

R: Sağ/Right L: Sol/Left ● Stokta/In Stock ○ Stokta Yok/Non Stock Item
Takımlar standart 1.5° helis açılı olarak üretilir. / The tools have a built in 1.5° helix angle.

Sipariş Örneği/Ordering Example : 1 ad./pcs. TER 1616 H16

DIŞ ÇAP SAĞ YÖNDE VİDA AÇMA
EXTERNAL RIGHT HAND THREADING OPERATION

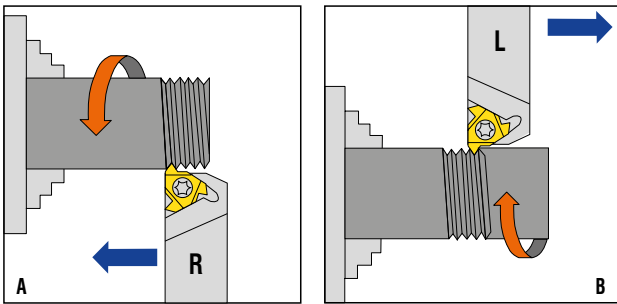

DIŞ ÇAP SOL YÖNDE VİDA AÇMA
EXTERNAL LEFT HAND THREADING OPERATION

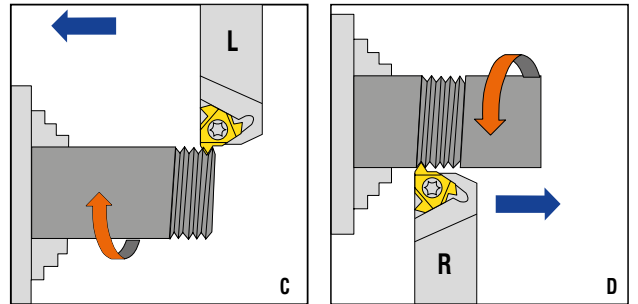

UYARI / WARNING

Figür B ve D için; negatif açılı altlık kullanılmalıdır. / For figure B and D; negative shim must be used.
Altıksız katerlerde B ve D figürü uygulanamaz. / B and D figures can not be applied on tools without shim.

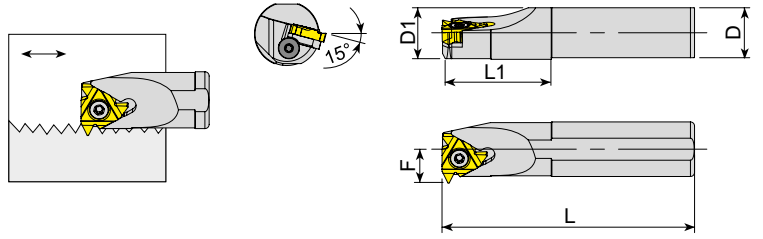

Takım Kodu Ordering Code	Takım Ölçüleri (mm) Dimension (mm)								Kesici Uç Insert	Yedek Parçaları Spare Parts						
	Stok Stock		D	D1	L	L1	F	D min		Sıkma Vidası Screw	Sol Altlık Left Shim	Sağ Altlık Right Shim	Altlık Vidası Shim Screw	Baskı Parçası Wedge Clamp	Baskı Vidası Clamp Screw	Tork Anahtar Torx Key
	R	L														
TIR/L S25R 16	●	●	25	25	200	-	16.2	29	16 IR/L	1710-U5-40x12.2	ATS-16E	ATS-16I	AAV-11-U5-40x4.5	-	-	80-T10
TIR/L S32S 16	●	●	32	32	250	-	19.7	36								
TIR/L S40T 16	●	●	40	40	300	-	23.7	44								
TIR/L S50U 16	●	●	50	50	350	-	28.7	54								
TIR/L S25R 22	●	●	25	25	200	-	18.1	29	22 IR/L	1720-U8-32x15	ATS-22E	ATS-22I	AAV-12-U8-32x5.5	-	-	80-T20
TIR/L S32S 22	●	●	32	32	250	-	21.6	38								
TIR/L S40T 22	●	●	40	40	300	-	25.6	46								
TIR/L S50U 22	●	●	50	50	350	-	30.6	58								
TIR/L S32S 27	●	●	32	32	250	-	22.6	40	27 IR/L	1620-M5x18	ATS-27E	ATS-27I	AAV-15-M5x5.7	-	-	80-T20
TIR/L S40T 27	●	●	40	40	300	-	26.6	48		1620-M5x22						
TIR/L S50U 27	●	●	50	50	350	-	31.6	58								

R: Sağ/Right L: Sol/Left ● Stokta/In Stock ○ Stokta Yok/Non Stock Item
Takımlar standart 1.5° helis açılı olarak üretilir. / The tools have a built in 1.5° helix angle.

Sipariş Örneği/Ordering Example : 1 ad./pcs. TIR S25R 16

DELİK İÇİ SAĞ YÖNDE VİDA AÇMA
INTERNAL RIGHT HAND THREADING OPERATION

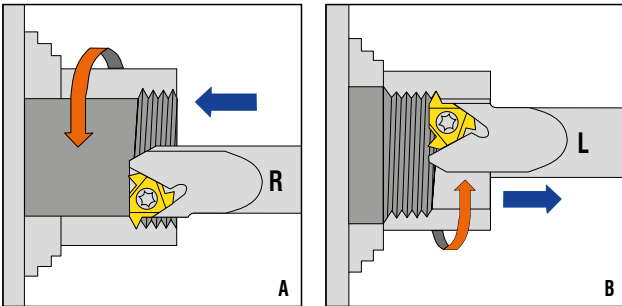

DELİK İÇİ SOL YÖNDE VİDA AÇMA
INTERNAL LEFT HAND THREADING OPERATION

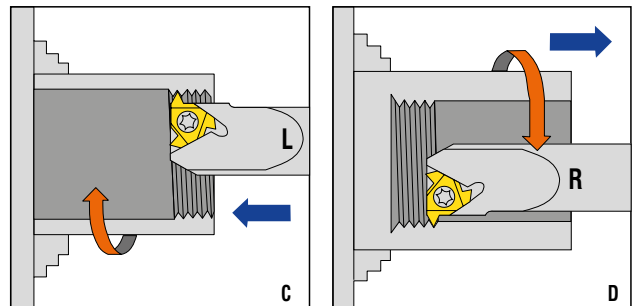

UYARI / WARNING

Figür B ve D için; negatif açılı altlık kullanılmalıdır. / For figure B and D; negative shim must be used.
Altıksız katerlerde B ve D figürü uygulanamaz. / B and D figures can not be applied on tools without shim.

Diş Helis Açısı Thread Helix Angle

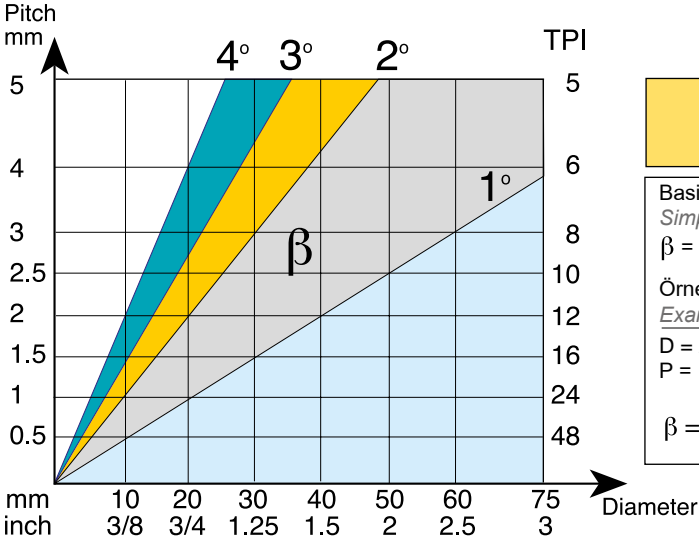

$$\tan \beta = \frac{P}{\pi \times D}$$

Basitleştirilmiş formül
Simplified formula

$$\beta = 20 P/D$$

Örnek :

Example:

$$D = 25 \text{ mm (0.98")}$$

$$P = 1.5 \text{ mm (16 TPI)}$$

$$\beta = \frac{25 \times 1.5}{40} = 1.25^\circ$$

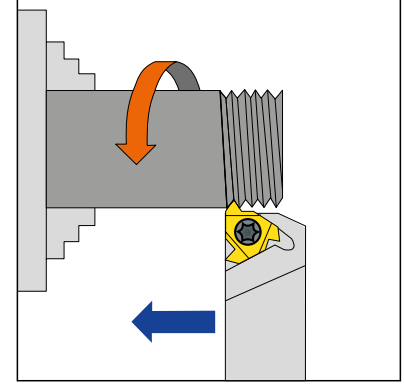

Standart ve Eğik Altlıklar Standard and Slanted Shim

Akko diş açma takımlarının, uç yuvaları 1.5° helis açılı olarak üretilir. Farklı helis açılı diş açmak isteyenler altlığı değiştirerek istedikleri dereceyi elde edebilirler.

Negatif helis genellikle sol katerde sağ diş çekmek için kullanılır ya da sağ katerde sol diş çekmek için kullanılır.

Akko Toolholders Pockets have a built in 1.5° helix angle. This angle may be adjusted to better match the thread helix angle by simply changing the shim.

Negative helix is usually used when threading RH thread with LH Holder or LH thread with RH Holder.

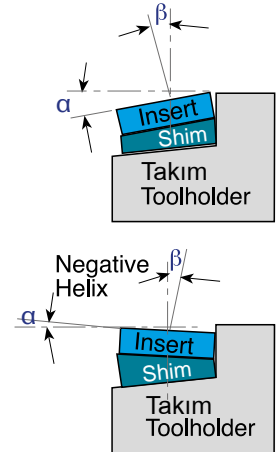

L	IC	Takım Tipi Tool Type	Uç Yuvasının Açısı (α) Pocket's Angle (α)						
			4.5°	3.5°	2.5°	1.5°	0.5°	-0.5°	-1.5°
16	3/8	EX-RH or IN-LH	ATS-16E+4.5	ATS-16E+3.5	ATS-16E+2.5	ATS-16E	ATS-16E+0.5	ATS-16E-0.5	ATS-16E-1.5
16	3/8	EX-LH or IN-RH	ATS-16I+4.5	ATS-16I+3.5	ATS-16I+2.5	ATS-16I	ATS-16I+0.5	ATS-16I-0.5	ATS-16I-1.5
22	1/2	EX-RH or IN-LH	ATS-22E+4.5	ATS-22E+3.5	ATS-22E+2.5	ATS-22E	ATS-22E+0.5	ATS-22E-0.5	ATS-22E-1.5
22	1/2	EX-LH or IN-RH	ATS-22I+4.5	ATS-22I+3.5	ATS-22I+2.5	ATS-22I	ATS-22I+0.5	ATS-22I-0.5	ATS-22I-1.5
27	5/8	EX-RH or IN-LH	ATS-27E+4.5	ATS-27E+3.5	ATS-27E+2.5	ATS-27E	ATS-27E+0.5	ATS-27E-0.5	ATS-27E-1.5
27	5/8	EX-LH or IN-RH	ATS-27I+4.5	ATS-27I+3.5	ATS-27I+2.5	ATS-27I	ATS-27I+0.5	ATS-27I-0.5	ATS-27I-1.5

Altılık Değişirme Öneri Tablosu / Shim Change Recommendation

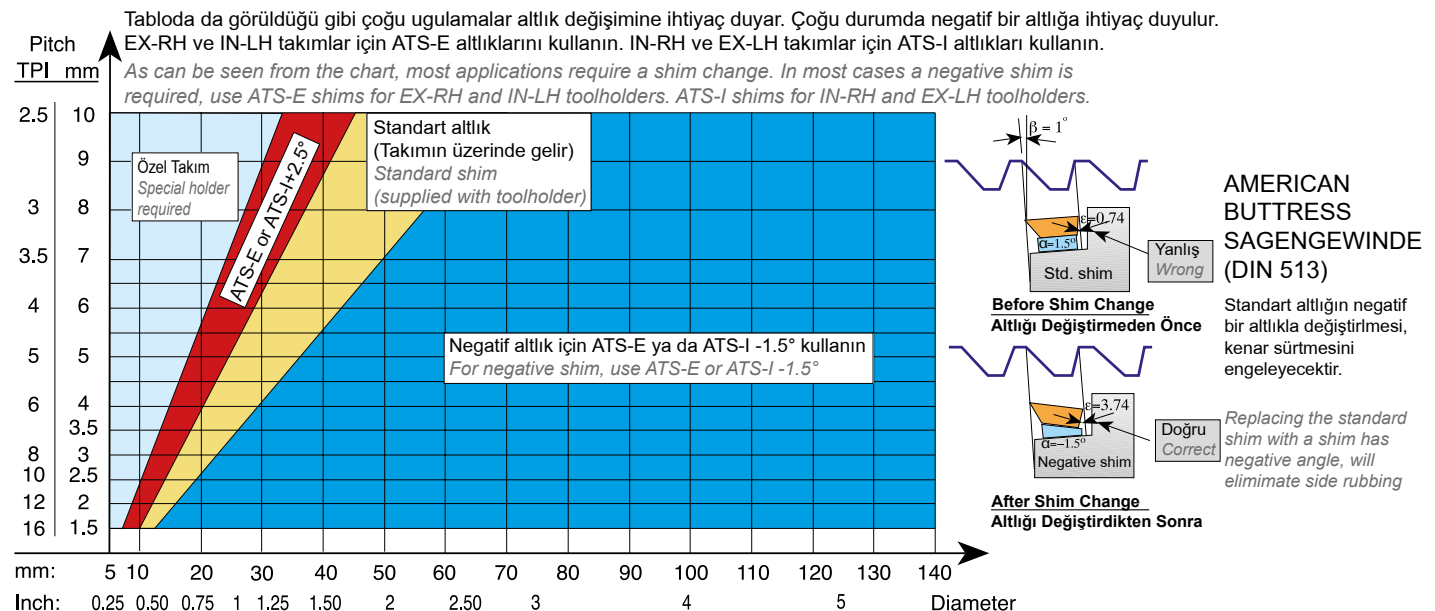
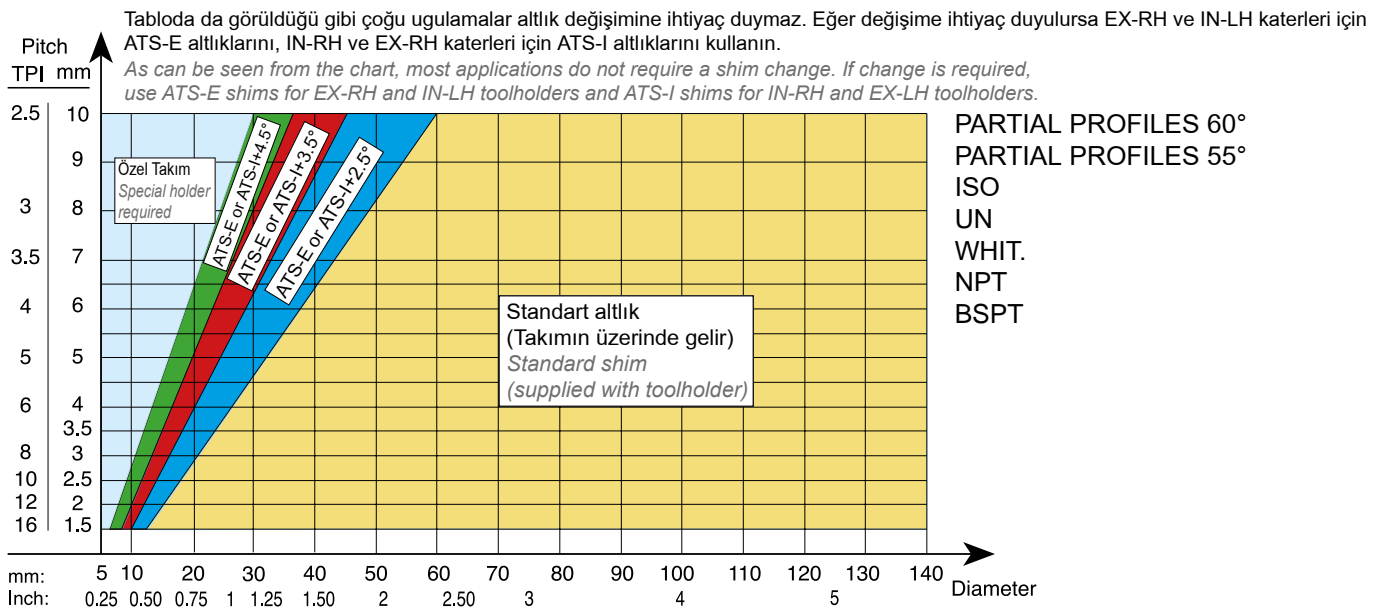
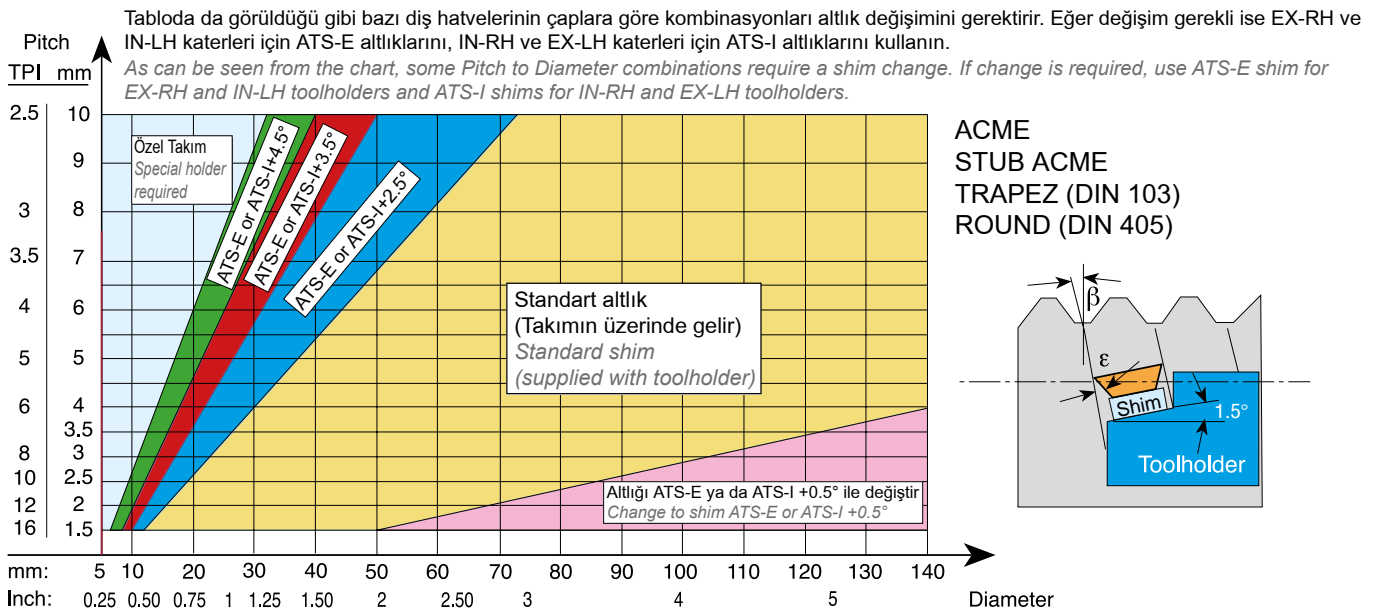



konusulan
the spoken kalite...
quality...

KANAL AÇMA

KANAL AÇMA TAKIMLARI
GROOVING TOOLHOLDERS



www.akkо.com.tr

Дистрибьютер ООО "Ресурс Плюс"
+7 (351) 247-74-40; info@rp-ural.ru

AKKO **A** **AKT** - **K** - **R** - **2525**

100 - 150 - **4** - **T22**

2 Kesiş Stili / Cutter Style

DKT : Dış Çap Kanal Açma Takımı - *External Grooving Toolholders*
IKT : Delik İçi Kanal Açma Takımı - *Internal Grooving Toolholders*
AKT : Dış Çap Alın Kanal Açma Takımı - *Face Grooving Toolholders*
LKT : L Tip Alın Kanal Açma Takımları - *L Type Face Grooving Toolholders*

3 Uç Tipi / Insert Type

KRLY / MGM.
HRN / S312, S229, S224, S223
ISCR / DGN, GI, GTN
SNDVK / 123, 151, 154.91
ZCC
KM / A4.
ARN / LOMR.

TGTC / TD.

4 Kesme Yönü / Cutting Direction

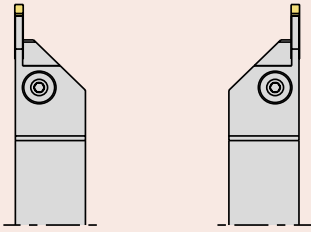

R

L

5 Kesme Kenar Yüksekliği ve Şaft Geniřlięi Cutting Edge Height and Shank Width

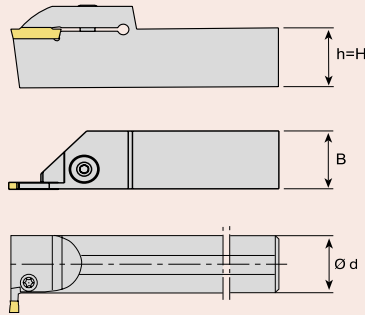

6 Kesme Aralıęı / Cutting Diameter

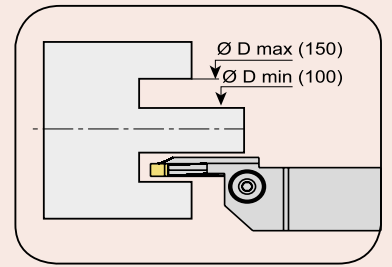

7 Kesme Kenar Geniřlięi / Cutting Width Edge

ÖR/E.G. :
2 = 2.0 mm
3 = 3.0 mm
4 = 4.0 mm
5 = 5.0 mm
6 = 6.0 mm
8 = 8.0 mm

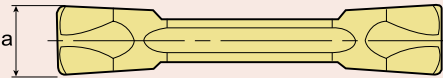

8 Kesme Derinlięi / Cutting Depth

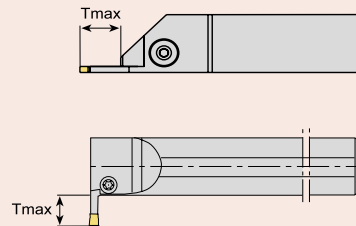

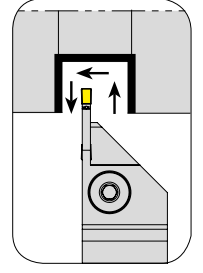
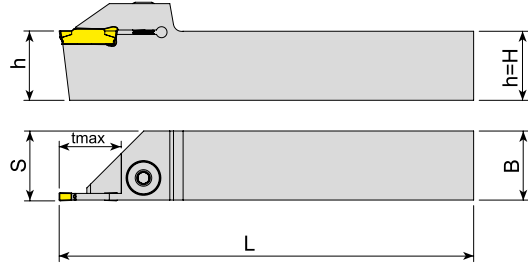

Takım Kodu Ordering Code	Stok Stock		Takım Ölçüleri (mm) Dimension (mm)					Kesici Uç Insert	Yedek Parçaları Spare Parts		
	R	L	h=H	B	L	S	t _{max}		Sıkma Vidası Clamp Screw	Pul Stamp	Anahtar Allen Key
ADKT-K-R/L-1212-2-T15	●	●	12	12	100	16.3	15	MGM. - 2	AKV-02-M6x22	ABPL-01	AAL-03-3
ADKT-K-R/L-1616-2-T15	●	●	16	16	125	16.3	15				
ADKT-K-R/L-2020-2-T15	●	●	20	20	125	20.3	15				
ADKT-K-R/L-2525-2-T15	●	●	25	25	150	25.3	15				
ADKT-K-R/L-3232-2-T15	●	●	32	32	170	32.3	15				
ADKT-K-R/L-1212-3-T15	●	●	12	12	100	16.3	15	MGM. - 3			
ADKT-K-R/L-1616-3-T15	●	●	16	16	125	16.4	15				
ADKT-K-R/L-2020-3-T20	●	●	20	20	125	20.4	20				
ADKT-K-R/L-2020-3-R28	●	○	20	20	125	20.3	28				
ADKT-K-R/L-2525-3-R15	●	○	25	25	150	25.4	15				
ADKT-K-R/L-2525-3-T22	●	●	25	25	150	25.4	22				
ADKT-K-R/L-3232-3-T22	●	●	32	32	170	32.4	22	MGM. - 4	2004-M8x1x20	-	AAL-05-4
ADKT-K-R/L-2020-4-T20	●	●	20	20	125	20.4	20				
ADKT-K-R/L-2020-4-R25	●	○	20	20	125	20.4	25				
ADKT-K-R/L-2525-4-T18	●	●	25	25	150	25.4	18				
ADKT-K-R/L-2525-4-T22	●	●	25	25	150	25.4	22				
ADKT-K-R/L-3232-4-T22	●	●	32	32	170	32.4	22	MGM. - 5			
ADKT-K-R/L-2020-5-T20	●	●	20	20	125	20.5	20				
ADKT-K-R/L-2525-5-T18	●	●	25	25	150	25.5	18				
ADKT-K-R/L-2525-5-T25	●	●	25	25	150	25.5	25				
ADKT-K-R/L-3232-5-T25	●	●	32	32	170	32.5	25	MGM. - 6			
ADKT-K-R/L-2525-6-T25	●	●	25	25	150	25.6	25				
ADKT-K-R/L-3232-6-T25	●	●	32	32	170	32.6	25	MGM. - 8			
ADKT-K-R/L-3232-8-T32	●	●	32	32	170	32.8	32				

R: Sağ/Right L: Sol/Left ● Stokta/In Stock ○ Stokta Yok/Non Stock Item
KRLY - JD Ucuna Uygundur. / Compatiple with KRLY - JD Insert.

Sipariş Örneği/Ordering Example : 1 ad./pcs. ADKT-K-R-1212-2-T15

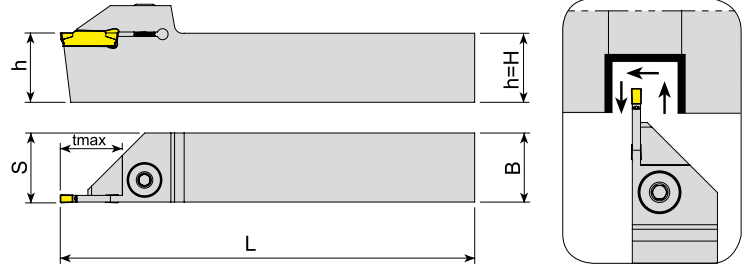

Takım Kodu Ordering Code	Stok Stock		Takım Ölçüleri (mm) Dimension (mm)					Kesici Uç Insert	Yedek Parçaları Spare Parts		
	R	L	h=H	B	L	S	t max		Sıkma Vidası Clamp Screw	Pul Stamp	Anahtar Allen Key
ADKT-KG-R/L-2020-2-T15	●	○	20	20	125	20.2	15	KG.. - 2	AKV-02-M6x22	ABPL-01	AAL-03-3
ADKT-KG-R/L-2525-2-T15	●	○	25	25	150	25.2	15				
ADKT-KG-R/L-2525-2-T17	●	○	25	25	150	25.2	17	KG.. - 3	2004-M8x1x20	-	AAL-05-4
ADKT-KG-R/L-1616-3-T20	●	●	16	16	125	16.3	20				
ADKT-KG-R/L-2020-3-T20	●	●	20	20	125	20.3	20	KG.. - 4	2004-M8x1x20	-	AAL-05-4
ADKT-KG-R/L-2525-3-T22	●	●	25	25	150	25.3	22				
ADKT-KG-R/L-2020-4-T20	●	○	20	20	125	20.4	20	KG.. - 5	2004-M8x1x20	-	AAL-05-4
ADKT-KG-R/L-2525-4-T22	●	○	25	25	150	25.4	22				
ADKT-KG-R/L-2525-5-T25	○	○	25	25	150	25.5	25	KG.. - 6	2004-M8x1x20	-	AAL-05-4
ADKT-KG-R/L-2525-6-T25	○	○	25	25	150	25.6	25				

KRLY Ucuna Uygundur. / Compatible with KRLY Insert.

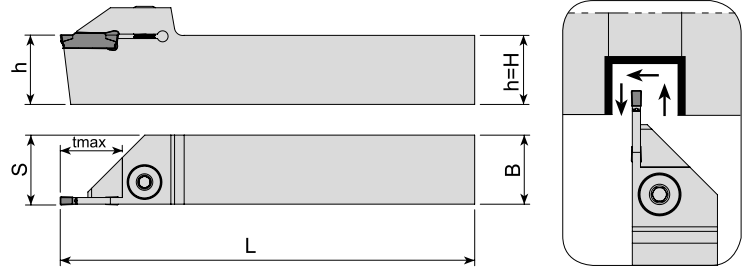

Takım Kodu Ordering Code	Stok Stock		Takım Ölçüleri (mm) Dimension (mm)					Kesici Uç Insert	Yedek Parçaları Spare Parts		
	R	L	h=H	B	L	S	t max		Sıkma Vidası Clamp Screw	Pul Stamp	Anahtar Allen Key
ADKT-SGC-R/L-1212-2-R15	●	●	12	12	100	16.2	15	GCM N20	AKV-02-M6x22	ABPL-01	AAL-03-3
ADKT-SGC-R/L-1616-2-R15	●	●	16	16	125	16.2	15				
ADKT-SGC-R/L-2020-2-R20	●	●	20	20	125	20.2	20	GCM N30	2004-M8x1x20	-	AAL-05-4
ADKT-SGC-R/L-2525-2-R20	●	●	25	25	150	25.2	20				
ADKT-SGC-R/L-1212-3-R15	●	●	12	12	100	16.3	15	GCM N40	2004-M8x1x20	-	AAL-05-4
ADKT-SGC-R/L-1616-3-R15	●	●	16	16	125	16.3	15				
ADKT-SGC-R/L-2020-3-R22	●	○	20	20	125	20.3	22	GCM N40	2004-M8x1x20	-	AAL-05-4
ADKT-SGC-R/L-2525-3-R15	●	○	25	25	150	25.3	15				
ADKT-SGC-R/L-2525-3-R22	●	●	25	25	150	25.3	22	GCM N40	2004-M8x1x20	-	AAL-05-4
ADKT-SGC-R/L-2525-4-R25	●	○	25	25	150	25.4	25				

R: Sağ/Right L: Sol/Left ● Stokta/In Stock ○ Stokta Yok/Non Stock Item
SMTM Ucuna Uygundur. / Compatible with SMTM Insert.

Sipariş Örneği/Ordering Example : 1 ad./pcs. ADKT-KG-R-2020-2-T15

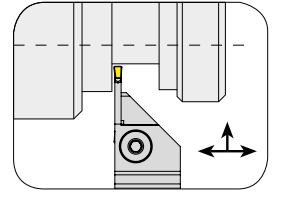
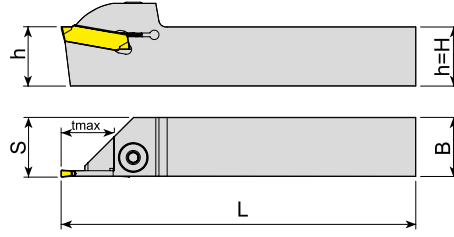

Takım Kodu Ordering Code	Stok Stock		Takım Ölçüleri (mm) Dimension (mm)					Kesici Uç Insert	Yedek Parçaları Spare Parts		
	R	L	h=H	B	L	S	t _{max}		Sıkma Vidası Clamp Screw	Pul Stamp	Anahtar Allen Key
ADKT-H-R/L-2020-3-T20	●	●	20	20	125	20.5	20	S229 - 3	2004-M8x1x20	-	AAL-05-4
ADKT-H-R/L-2525-3-T22	●	●	25	25	150	25.5	22				
ADKT-H-R/L-2020-4-T20	●	●	20	20	125	20.5	20	S229 - 4	2004-M8x1x20	-	AAL-05-4
ADKT-H-R/L-2525-4-T22	●	●	25	25	150	25.5	22				
ADKT-H-R/L-3232-4-T22	●	●	32	32	170	32.5	22	S229 - 5	2004-M8x1x20	-	AAL-05-4
ADKT-H-R/L-2020-5-T20	●	●	20	20	125	20.5	20				
ADKT-H-R/L-2525-5-T25	●	●	25	25	150	25.5	25	S229 - 6	2004-M8x1x20	-	AAL-05-4
ADKT-H-R/L-2525-6-T25	●	●	25	25	150	25.6	25				

HRN Ucuna Uygundur. / Compatible with HRN Insert.

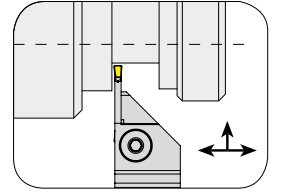
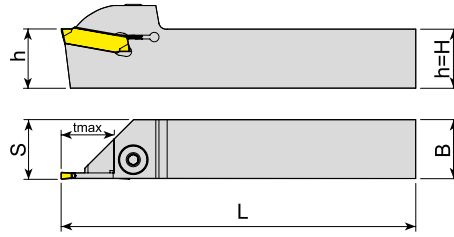

Takım Kodu Ordering Code	Stok Stock		Takım Ölçüleri (mm) Dimension (mm)					Kesici Uç Insert	Yedek Parçaları Spare Parts		
	R	L	h=H	B	L	S	t _{max}		Sıkma Vidası Clamp Screw	Pul Stamp	Anahtar Allen Key
ADKT-HK-R/L-1616-2-T15	●	●	16	16	125	16.3	15	S224 - 2	AKV-02-M6x22	ABPL-01	AAL-03-3
ADKT-HK-R/L-2020-2-T15	●	●	20	20	125	20.3	15				
ADKT-HK-R/L-2525-2-T15	●	●	25	25	150	25.3	15	S224 - 3	2004-M8x1x20	-	AAL-05-4
ADKT-HK-R/L-1616-3-T15	○	○	16	16	125	16.3	15				
ADKT-HK-R/L-2020-3-T20	●	●	20	20	125	20.4	20	S224 - 4	2004-M8x1x20	-	AAL-05-4
ADKT-HK-R/L-2525-3-T22	●	●	25	25	150	25.4	22				
ADKT-HK-R/L-2020-4-T20	●	●	20	20	125	20.4	20	S223 - 2	AKV-02-M6x22	ABPL-01	AAL-03-3
ADKT-HK-R/L-2525-4-T22	●	●	25	25	150	25.4	22				
ADKT-HS223-R/L-2020-2-T15	●	○	20	20	125	20.4	15				

R: Sağ/Right L: Sol/Left ● Stokta/In Stock ○ Stokta Yok/Non Stock Item
HRN Ucuna Uygundur. / Compatible with HRN Insert.

Sipariş Örneği/Ordering Example : 1 ad./pcs. ADKT-H-R-2020-3-T20

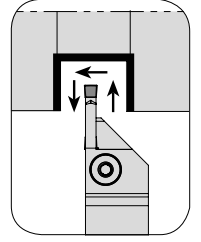
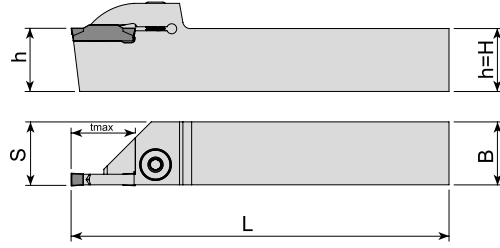

Takım Kodu Ordering Code	Stok Stock		Takım Ölçüleri (mm) Dimension (mm)				Kesici Uç Insert	Yedek Parçaları Spare Parts			
	R	L	h=H	B	L	S		t max	Sıkma Vidası Clamp Screw	Pul Stamp	Anahtar Allen Key
ADKT-ZCC2-R/L-1616-2-T15	●	●	16	16	125	16.3	15	Z.BD - 2	AKV-02-M6x22	ABPL-01	AAL-03-3
ADKT-ZCC2-R/L-2020-2-T15	●	●	20	20	125	20.3	15				
ADKT-ZCC2-R/L-2525-2-T15	●	●	25	25	150	25.3	15				
ADKT-ZCC2-R/L-2525-2.5-T15	●	●	25	25	150	25.3	15	Z.ED - 2.5			
ADKT-ZCC2-R/L-1616-3-T15	●	○	16	16	125	16.3	15	Z.FD - 3	2004-M8x1x20	-	AAL-05-4
ADKT-ZCC2-R/L-2020-3-T12	●	○	20	20	125	20.3	12				
ADKT-ZCC2-R/L-2020-3-T20	●	●	20	20	125	20.3	20				
ADKT-ZCC2-R/L-2525-3-T12	●	○	25	25	150	25.3	12				
ADKT-ZCC2-R/L-2525-3-T22	●	●	25	25	150	25.3	22				
ADKT-ZCC2-R/L-2525-3-R30	●	●	25	25	150	25.3	30				
ADKT-ZCC2-R/L-2020-4-T12	●	○	20	20	125	20.5	12	Z.GD - 4	2004-M8x1x20	-	AAL-05-4
ADKT-ZCC2-R/L-2020-4-T20	●	●	20	20	125	20.5	20				
ADKT-ZCC2-R/L-2525-4-T12	●	○	25	25	150	25.5	12				
ADKT-ZCC2-R/L-2525-4-T22	●	●	25	25	150	25.5	22	Z.HD - 5	2004-M8x1x20	-	AAL-05-4
ADKT-ZCC2-R/L-2020-5-T12	●	○	20	20	125	20.5	12				
ADKT-ZCC2-R/L-2020-5-T20	●	●	20	20	125	20.5	20				
ADKT-ZCC2-R/L-2525-5-T12	●	○	25	25	150	25.5	12	Z.KD - 6	2004-M8x1x20	-	AAL-05-4
ADKT-ZCC2-R/L-2525-5-T25	●	●	25	25	150	25.5	25				
ADKT-ZCC2-R/L-2020-6-T20	●	●	20	20	125	20.6	20				
ADKT-ZCC2-R/L-2525-6-T25	●	●	25	25	150	25.6	25	Z.KD - 6	2004-M8x1x20	-	AAL-05-4
ADKT-ZCC2-R/L-3232-6-T25	●	●	32	32	170	32.6	25				
ADKT-ZCC2-R/L-3232-6-T30	●	●	32	32	170	32.6	30				

R: Sağ/Right L: Sol/Left ● Stokta/In Stock ○ Stokta Yok/Non Stock Item
ZCC Ucuna Uygunudur. / Compatible with ZCC Insert.

Sipariş Örneği/Ordering Example : 1 ad./pcs. ADKT-ZCC2-R-1616-2-T15



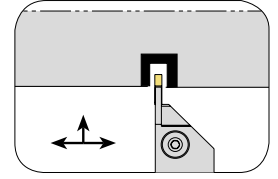
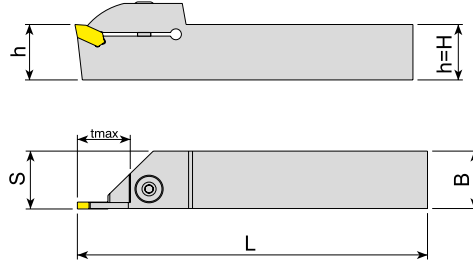

Takım Kodu Ordering Code	Stok Stock		Takım Ölçüleri (mm) Dimension (mm)					Kesici Uç Insert	Yedek Parçaları Spare Parts		
	R	L	h=H	B	L	S	t _{max}		Sıkma Vidası Clamp Screw	Pul Stamp	Anahtar Allen Key
ADKT-ZCC1-R/L-2020-3-T20	●	○	20	20	125	20.3	20	ZQMX - 3	2004-M8x1x20	-	AAL-05-4
ADKT-ZCC1-R/L-2525-3-T22	●	○	25	25	150	25.3	22				
ADKT-ZCC1-R/L-2020-4-T20	●	○	20	20	125	20.4	20	ZQMX - 4	2004-M8x1x20	-	AAL-05-4
ADKT-ZCC1-R/L-2525-4-T22	●	○	25	25	150	25.4	22				

ZCC Ucuna Uygun. / Compatible with ZCC Insert.

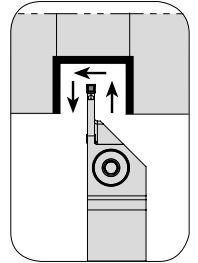
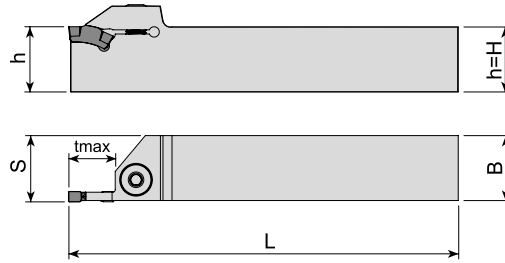

Takım Kodu Ordering Code	Stok Stock		Takım Ölçüleri (mm) Dimension (mm)					Kesici Uç Insert	Yedek Parçaları Spare Parts		
	R	L	h=H	B	L	S	t _{max}		Sıkma Vidası Clamp Screw	Pul Stamp	Anahtar Allen Key
ADKT-ITG-R/L-2020-3-T8	●	●	20	20	125	20.3	8	TGM. - 3	2004-M8x1x20	-	AAL-05-4
ADKT-ITG-R/L-2525-3-T8	●	●	25	25	150	25.3	8				
ADKT-ITG-R/L-3232-3-T8	●	○	32	32	170	32.3	8				
ADKT-ITG-R/L-2020-4-T9	●	●	20	20	125	20.4	9	TGM. - 4	2004-M8x1x20	-	AAL-05-4
ADKT-ITG-R/L-2525-4-T17	●	●	25	25	150	25.4	17				
ADKT-ITG-R/L-3232-4-T17	●	●	32	32	170	32.4	17				
ADKT-ITG-R/L-3232-5-T25	●	○	32	32	170	32.5	25	TGM. - 5	2004-M8x1x20	-	AAL-05-4

R: Sağ/Right L: Sol/Left ● Stokta/In Stock ○ Stokta Yok/Non Stock Item
ISCR Ucuna Uygun. / Compatible with ISCR Insert.

Sipariş Örneği/Ordering Example : 1 ad./pcs. ADKT-ZCC1-R-2020-3-T20

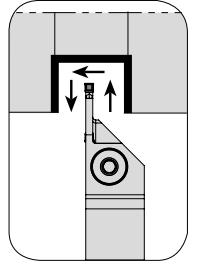
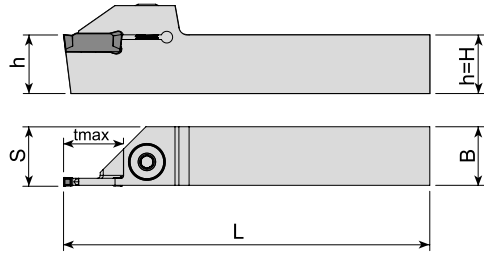

Takım Kodu Ordering Code	Stok Stock		Takım Ölçüleri (mm) Dimension (mm)					Kesici Uç Insert	Yedek Parçaları Spare Parts		
	R	L	h=H	B	L	S	t max		Sıkma Vidası Clamp Screw	Pul Stamp	Anahtar Allen Key
ADKT-I-R/L-1212-2-T15	●	●	12	12	125	16.3	15	DGN - 2	AKV-02-M6x22	ABPL-01	AAL-03-3
ADKT-I-R/L-1616-2-T15	●	●	16	16	100	16.3	15				
ADKT-I-R/L-2020-2-T15	●	●	20	20	125	20.3	15				
ADKT-I-R/L-2525-2-T15	●	●	25	25	150	25.3	15				
ADKT-I-R/L-3232-2-T15	●	●	32	32	170	32.3	15				
ADKT-I-R/L-1212-3-T15	●	●	12	12	100	16.3	15	DGN - 3			
ADKT-I-R/L-1616-3-T15	●	●	16	16	125	16.4	15				
ADKT-I-R/L-2020-3-T20	●	●	20	20	125	20.4	20				
ADKT-I-R/L-2525-3-T22	●	●	25	25	150	25.4	22				
ADKT-I-R/L-3232-3-T22	●	●	32	32	170	32.4	22				
ADKT-I-R/L-2020-4-T20	●	●	20	20	125	20.4	20	DGN / GRP - 4	2004-M8x1x20	-	AAL-05-4
ADKT-I-R/L-2525-4-T22	●	●	25	25	150	25.4	22				
ADKT-I-R/L-3232-4-T25	●	●	32	32	170	32.4	25	DGN / GRP - 5			
ADKT-I-R/L-2020-5-T20	●	●	20	20	125	20.5	20				
ADKT-I-R/L-2525-5-T25	●	●	25	25	150	25.5	25				
ADKT-IG-R/L-2020-3-R20	●	●	20	20	125	20.4	20	GRP - 3			
ADKT-IG-R/L-2525-3-T22	●	●	25	25	150	25.4	22				
ADKT-IGI-R/L-2020-2-T15	●	●	20	20	125	20.3	15	GIM / GIP - 2	AKV-02-M6x22	ABPL-01	AAL-03-3
ADKT-IGI-R/L-2525-2-T15	●	○	25	25	150	25.4	15				
ADKT-IGI-R/L-1616-3-T15	●	●	16	16	125	16.4	15	GIM / GIP - 3			
ADKT-IGI-R/L-2020-3-T20	●	●	20	20	125	20.4	20				
ADKT-IGI-R/L-2525-3-T22	●	●	25	25	150	25.4	22				
ADKT-IGI-R/L-2525-4-T22	●	●	25	25	150	25.5	22				
ADKT-IGI-R/L-2525-5-T25	●	●	25	25	150	25.6	25				
ADKT-IGI-R/L-2525-8-T30	●	○	25	25	150	25.8	30	GIM / GIP - 8	2004-M8x1x20	-	AAL-05-4
ADKT-IGI-R/L-2525-5-T25	●	●	25	25	150	25.6	25				
ADKT-IGTN-R/L-2525-5-T25	●	●	25	25	150	25.6	25	GTN - 5			
ADKT-IDC-R/L-2525-3-T21	●	○	25	25	150	25.4	21	DCE - 3			

R: Sağ/Right L: Sol/Left ● Stokta/In Stock ○ Stokta Yok/Non Stock Item
ISCR Ucuna Uygun. / Compatible With ISCR Insert

Sipariş Örneği/Ordering Example : 1 ad./pcs. ADKT-I-R-1212-2-T15

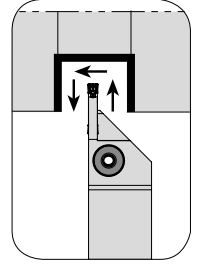
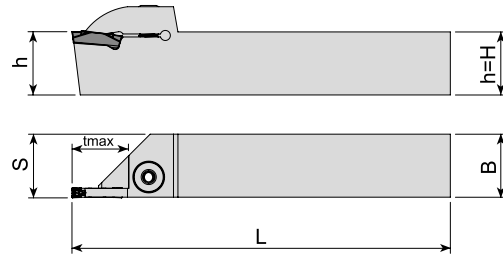

Takım Kodu Ordering Code	Stok Stock		Takım Ölçüleri (mm) Dimension (mm)					Kesici Uç Insert	Yedek Parçaları Spare Parts		
	R	L	h=H	B	L	S	t _{max}		Sıkma Vidası Clamp Screw	Pul Stamp	Anahtar Allen Key
ADKT-KM-R/L-2020-2-T15	●	●	20	20	125	20.3	15	A4. - 2	AKV-02-M6x22	ABPL-01	AAL-03-3
ADKT-KM-R/L-2525-2-T15	●	●	25	25	150	25.3	15				
ADKT-KM-R/L-2020-3-T20	●	●	20	20	125	20.4	20	A4. - 3	2004-M8x1x20	-	AAL-05-4
ADKT-KM-R/L-2525-3-T22	●	●	25	25	150	25.4	22				
ADKT-KM-R/L-2525-4-T22	●	●	25	25	150	25.5	22	A4. - 4			

KNMNTL Ucuna Uygun. / Compatible with KNMNTL Insert.

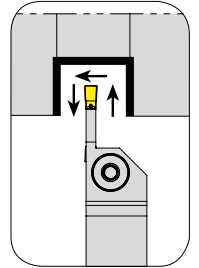
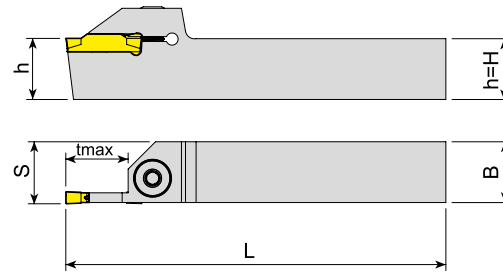

Takım Kodu Ordering Code	Stok Stock		Takım Ölçüleri (mm) Dimension (mm)					Kesici Uç Insert	Yedek Parçaları Spare Parts		
	R	L	h=H	B	L	S	t _{max}		Sıkma Vidası Clamp Screw	Pul Stamp	Anahtar Allen Key
ADKT-123-R/L-1212-1.5-R15	●	●	12	12	100	16.2	15	123 - 1.5	AKV-02-M6x22	ABPL-01	AAL-03-3
ADKT-123-R/L-1616-1.5-R15	●	●	16	16	125	16.3	15				
ADKT-123-R/L-1616-2-T15	●	○	16	16	125	16.3	15	123 - 2	AKV-02-M6x22	ABPL-01	AAL-03-3
ADKT-123-R/L-2020-2-T8	●	○	20	20	125	20.2	8				
ADKT-123-R/L-2020-2-T15	●	●	20	20	125	20.3	15	123 - 3	2004-M8x1x20	-	AAL-05-4
ADKT-123-R/L-2525-2-T15	●	●	25	25	150	25.3	15				
ADKT-123-R/L-3232-2-T15	●	●	32	32	170	32.3	15	123 - 4	2004-M8x1x20	-	AAL-05-4
ADKT-123-R/L-1616-3-T15	●	●	16	16	125	16.4	15				
ADKT-123-R/L-2020-3-T20	●	●	20	20	125	20.4	20	123 - 5	2004-M8x1x20	-	AAL-05-4
ADKT-123-R/L-2525-3-T22	●	●	25	25	150	25.4	22				
ADKT-123-R/L-2020-4-T20	●	●	20	20	125	20.4	20	123 - 6	2004-M8x1x20	-	AAL-05-4
ADKT-123-R/L-2525-4-T22	●	●	25	25	150	25.4	22				
ADKT-123-R/L-3232-4-T25	●	●	32	32	170	32.4	25	123 - 5	2004-M8x1x20	-	AAL-05-4
ADKT-123-R/L-2020-5-T20	●	●	20	20	125	20.5	20				
ADKT-123-R/L-2525-5-T25	●	●	25	25	150	25.5	25	123 - 6	2004-M8x1x20	-	AAL-05-4
ADKT-123-R/L-3232-6-T15	●	○	32	32	170	32.5	15				

R: Sağ/Right L: Sol/Left ● Stokta/In Stock ○ Stokta Yok/Non Stock Item
SNDVK Ucuna Uygun. / Compatible with SNDVK Insert.

Sipariş Örneği/Ordering Example : 1 ad./pcs. ADKT-KM-R-2020-2-T15

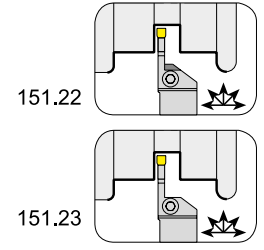
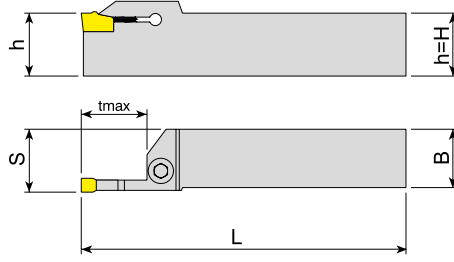

Takım Kodu Ordering Code	Stok Stock		Takım Ölçüleri (mm) Dimension (mm)					Kesici Uç Insert	Yedek Parçaları Spare Parts		
	R	L	h=H	B	L	S	t max		Sıkma Vidası Clamp Screw	Pul Stamp	Anahtar Allen Key
ADKT-151.22-R/L-1616-2-T15	●	●	16	16	125	16.3	15	151.2 - 2	AKV-02-M6x22	ABPL-01	AAL-03-3
ADKT-151.22-R/L-2020-2-T15	●	●	20	20	125	20.3	15				
ADKT-151.22-R/L-2525-2-T15	●	●	25	25	150	25.3	15				
ADKT-151.22-R/L-1616-3-T15	●	●	16	16	125	16.4	15	151.2 - 3	2004-M8x1x20	-	AAL-05-4
ADKT-151.22-R/L-2020-3-T20	●	●	20	20	125	20.4	20				
ADKT-151.22-R/L-2525-3-T22	●	●	25	25	150	25.4	22				
ADKT-151.22-R/L-1616-4-T15	●	●	16	16	125	16.4	15	151.2 - 4	2004-M8x1x20	-	AAL-05-4
ADKT-151.22-R/L-2020-4-T20	●	●	20	20	125	20.4	20				
ADKT-151.22-R/L-2525-4-T22	●	●	25	25	150	25.4	22				
ADKT-151.22-R/L-2020-5-T20	●	●	20	20	125	20.5	20	151.2 - 5	2004-M8x1x20	-	AAL-05-4
ADKT-151.22-R/L-2525-5-T25	●	●	25	25	150	25.5	25				
ADKT-151.23-R/L-1616-2-T15	●	●	16	16	125	16.3	15	151.2 - 2	AKV-02-M6x22	ABPL-01	AAL-03-3
ADKT-151.23-R/L-2020-2-T15	●	●	20	20	125	20.3	15				
ADKT-151.23-R/L-2525-2-T15	●	●	25	25	150	25.3	15				
ADKT-151.23-R/L-1616-2.5-T15	●	●	16	16	125	16.3	15	151.2 - 2.5	2004-M8x1x20	-	AAL-05-4
ADKT-151.23-R/L-2020-2.5-T15	●	●	20	20	125	20.3	15				
ADKT-151.23-R/L-2525-2.5-T15	●	●	25	25	150	25.3	15				
ADKT-151.23-R/L-1212-3-T15	●	●	12	12	100	16.4	15	151.2 - 3	2004-M8x1x20	-	AAL-05-4
ADKT-151.23-R/L-1616-3-T15	●	●	16	16	125	16.4	15				
ADKT-151.23-R/L-2020-3-T20	●	●	20	20	125	20.4	20				
ADKT-151.23-R/L-2525-3-T20	●	●	25	25	150	25.4	20	151.2 - 4	2004-M8x1x20	-	AAL-05-4
ADKT-151.23-R/L-2525-3-T22	●	●	25	25	150	25.4	22				
ADKT-151.23-R/L-1616-4-T15	●	●	16	16	125	16.4	15				
ADKT-151.23-R/L-2020-4-T20	●	●	20	20	125	20.4	20	151.2 - 5	2004-M8x1x20	-	AAL-05-4
ADKT-151.23-R/L-2525-4-T22	●	●	25	25	150	25.4	22				
ADKT-151.23-R/L-2020-5-T20	●	●	20	20	125	20.5	20	151.2 - 5	2004-M8x1x20	-	AAL-05-4
ADKT-151.23-R/L-2525-5-T25	●	●	25	25	150	25.5	25				

R: Sağ/Right L: Sol/Left ● Stokta/In Stock ○ Stokta Yok/Non Stock Item
SNDVK Ucuna Uygundur. / Compatible with SNDVK Insert.

Sipariş Örneği/Ordering Example : 1 ad./pcs. ADKT-151.22-R-1616-2-T15

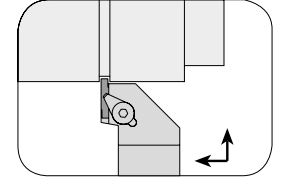
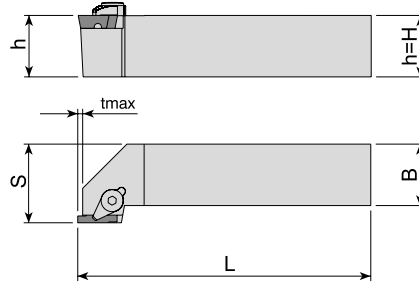

Takım Kodu Ordering Code	Stok Stock		Takım Ölçüleri (mm) Dimension (mm)					Kesici Uç Insert	Yedek Parçaları Spare Parts			
	R	L	h=H	B	L	S	t _{max}		Baskı Parçası Wedge Clamp	Sıkma Vidası Clamp Screw	Pim Pin	Anahtar Allen Key
ADKT-154.91-R/L-2020-3-T4	●	●	20	20	125	25	4			AKV-07-M6x22	APM-06	
ADKT-154.91-R/L-2525-3-T4	●	●	25	25	150	30.5	4					
ADKT-154.91-R/L-2020-5-T5	●	●	20	20	125	25	5		ACK-03	AKV-07-M6x22	APM-06	AAL-03-3
ADKT-154.91-R/L-2525-5-T5	●	●	25	25	150	30.5	5					

SNDVK Ucuna Uygundur. / Compatible with SNDVK Insert.

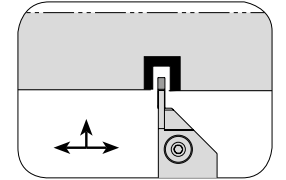
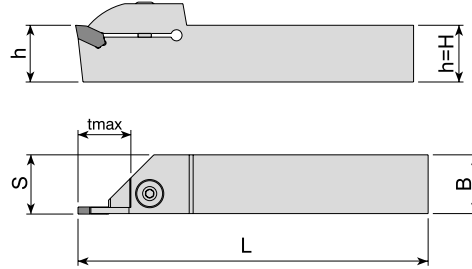

Takım Kodu Ordering Code	Stok Stock		Takım Ölçüleri (mm) Dimension (mm)					Kesici Uç Insert	Yedek Parçaları Spare Parts		
	R	L	h=H	B	L	S	t _{max}		Sıkma Vidası Clamp Screw	Pul Stamp	Anahtar Allen Key
ADKT-ARN-R/L-2020-2-T15	●	●	20	20	125	20.3	15		AKV-02-M6x22	ABPL-01	
ADKT-ARN-R/L-2525-2-T15	●	●	25	25	150	25.3	15				
ADKT-ARN-R/L-2020-3-T20	●	●	20	20	125	20.4	20		2004-M8x1x20	-	AAL-05-4
ADKT-ARN-R/L-2525-3-T22	●	●	25	25	150	25.4	22				

R: Sağ/Right L: Sol/Left ● Stokta/In Stock ○ Stokta Yok/Non Stock Item
ARN Ucuna Uygundur. / Compatible with ARN Insert.

Sipariş Örneği/Ordering Example : 1 ad./pcs. ADKT-154.91-R-2020-3-T4

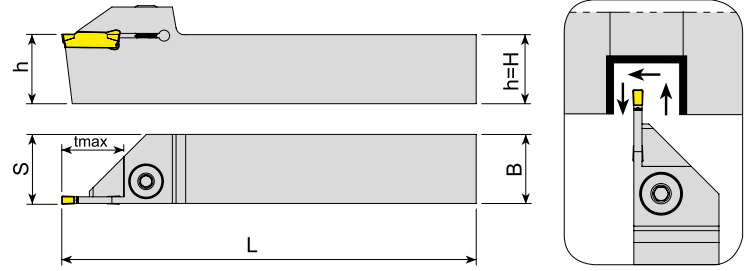

Takım Kodu Ordering Code	Stok Stock		Takım Ölçüleri (mm) Dimension (mm)					Kesici Uç Insert	Yedek Parçaları Spare Parts		
	R	L	h=H	B	L	S	t max		Sıkma Vidası Clamp Screw	Pul Stamp	Anahtar Allen Key
ADKT-TD-R/L-1212-2-T15	●	●	12	12	100	16.3	15	TD. - 2	AKV-02-M6x22	ABPL-01	AAL-03-3
ADKT-TD-R/L-1616-2-T15	●	●	16	16	125	16.3	15				
ADKT-TD-R/L-2020-2-T15	●	●	20	20	125	20.3	15				
ADKT-TD-R/L-2525-2-T17	●	●	25	25	150	25.3	17				
ADKT-TD-R/L-1212-3-T15	●	○	12	12	100	16.3	15	TD. - 3	2004-M8x1x20	-	AAL-05-4
ADKT-TD-R/L-1616-3-T15	●	●	16	16	125	16.4	15				
ADKT-TD-R/L-2020-3-T20	●	●	20	20	125	20.4	20				
ADKT-TD-R/L-2525-3-T9	●	●	25	25	150	25.4	9				
ADKT-TD-R/L-2525-3-T22	●	●	25	25	150	25.4	22	TD. - 4			
ADKT-TD-R/L-2525-4-T22	●	●	25	25	150	25.5	22				
ADKT-TD-R/L-2525-5-T25	○	○	25	25	150	25.5	25	TD. - 5			

TGTC Ucuna Uygun. / Compatible With TGTC Insert.

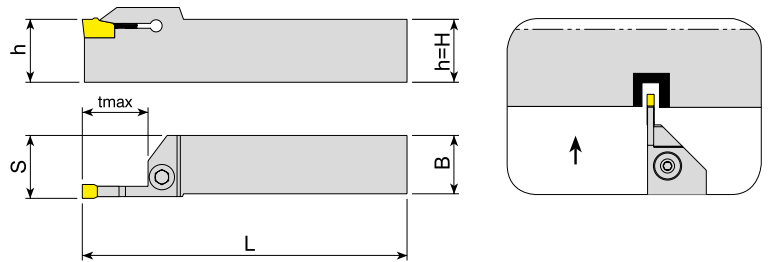

Takım Kodu Ordering Code	Stok Stock		Takım Ölçüleri (mm) Dimension (mm)					Kesici Uç Insert	Yedek Parçaları Spare Parts		
	R	L	h=H	B	L	S	t max		Sıkma Vidası Clamp Screw	Pul Stamp	Anahtar Allen Key
ADKT-SWC-R/L-2020-2-T25	●	○	20	20	125	20.3	25	WCF. - 2	AKV-02-M6x22	ABPL-01	AAL-03-3
ADKT-SWC-R/L-2020-3-T25	●	○	20	20	125	20.4	25	WCF. - 3	2004-M8x1x20	-	AAL-05-4

R: Sağ/Right L: Sol/Left ● Stokta/In Stock ○ Stokta Yok/Non Stock Item
SMTM Ucuna Uygun. / Compatible with SMTM Insert.

Sipariş Örneği/Ordering Example : 1 ad./pcs. ADKT-TD-R-1212-2-T15

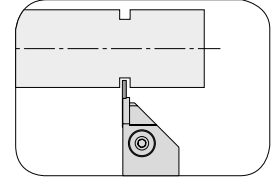
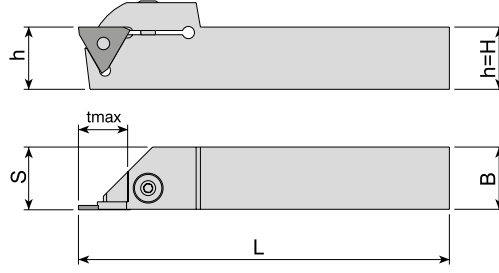

Takım Kodu Ordering Code	Stok Stock		Takım Ölçüleri (mm) Dimension (mm)					Kesici Uç Insert	Yedek Parçaları Spare Parts			
	R	L	h=H	B	L	S	t _{max}		Sıkma Vidası Clamp Screw	Pul Stamp	Anahtar Allen Key	
ADKT-H22-R/L-1616-(0.5-2)-T6	●	●	16	16	125	16.2	6				-	AAL-05-4
ADKT-H22-R/L-2020-(0.5-2)-T6	●	●	20	20	125	20.2	6					
ADKT-H22-R/L-2525-(0.5-2)-T6	●	●	25	25	150	25.2	6					

HRN Ucuna Uygunudur. / Compatible with HRN Insert.

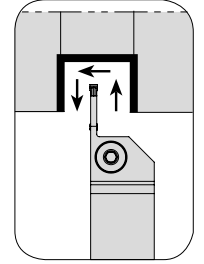
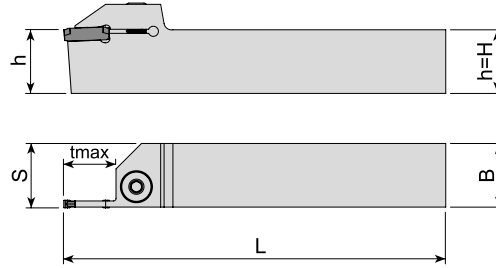

Takım Kodu Ordering Code	Stok Stock		Takım Ölçüleri (mm) Dimension (mm)					Kesici Uç Insert	Yedek Parçaları Spare Parts			
	R	L	h=H	B	L	S	t _{max}		Sıkma Vidası Clamp Screw	Pul Stamp	Anahtar Allen Key	
ADKT-LGC-R/L-1616-2-D40	●	●	16	16	125	16.2	20		AKV-02-M6x22	ABPL-01	-	AAL-03-3
ADKT-LGC-R/L-2020-2-D40	●	●	20	20	125	20.2	20					
ADKT-LGC-R/L-2525-2-D40	●	●	25	25	150	25.2	20					
ADKT-LGC-R/L-1616-3-T20	●	●	16	16	125	16.3	20		2004-M8x1x20	-	-	AAL-05-4
ADKT-LGC-R/L-2020-3-T20	●	●	20	20	125	20.3	20					
ADKT-LGC-R/L-2525-3-T20	●	●	25	25	150	25.3	20					

R: Sağ/Right L: Sol/Left ● Stokta/In Stock ○ Stokta Yok/Non Stock Item
LMN Ucuna Uygunudur. / Compatible with LMN Insert.

Sipariş Örneği/Ordering Example : 1 ad./pcs. ADKT-H22-R-1616-(0.5-2)T16

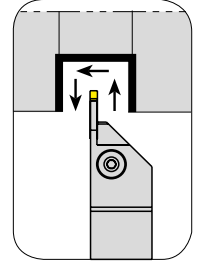
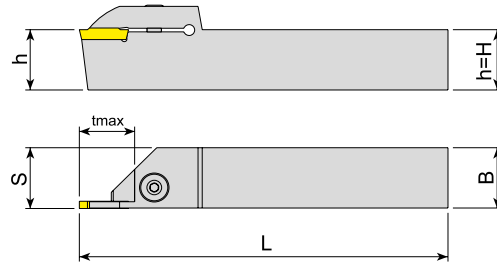

Takım Kodu Ordering Code	Stok Stock		Takım Ölçüleri (mm) Dimension (mm)					Kesici Uç Insert	Yedek Parçaları Spare Parts		
	R	L	h=H	B	L	S	t max		Sıkma Vidası Clamp Screw	Pul Stamp	Anahtar Allen Key
	ADKT-WGX24-R/L-2525-3-T22	●	○	25	25	150	25.3		22	GX24. - 3	2004-M8x1x20
ADKT-WGX24-R/L-2525-4-T22	●	●	25	25	150	25.4	22	GX24. - 4			
ADKT-WGX24-R/L-2525-5-T25	●	●	25	25	150	25.5	25	GX24. - 5			
ADKT-WGX24-R/L-3232-5-T25	●	○	32	32	170	32.5	25				

WLTR Ucuna Uygundur. / Compatible with WLTR Insert.

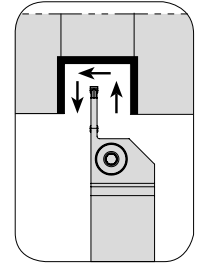
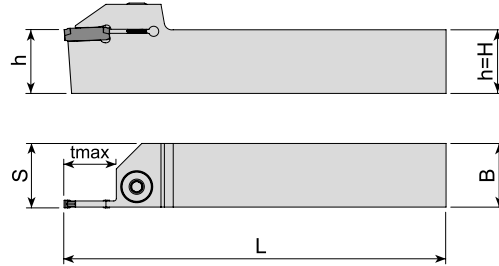

Takım Kodu Ordering Code	Stok Stock		Takım Ölçüleri (mm) Dimension (mm)					Kesici Uç Insert	Yedek Parçaları Spare Parts		
	R	L	h=H	B	L	S	t max		Sıkma Vidası Clamp Screw	Pul Stamp	Anahtar Allen Key
	ADKT-GP-R/L-2020-3-T20	●	●	20	20	125	20.3		20	GP - 3	2004-M8x1x20
ADKT-GP-R/L-2525-3-T22	●	●	25	25	150	25.3	22	GP - 4			
ADKT-GP-R/L-2525-4-T22	●	●	25	25	150	25.4	22				
ADKT-GP-R/L-2525-5-T25	●	●	25	25	150	25.5	25	GP - 5			

R: Sağ/Right L: Sol/Left ● Stokta/In Stock ○ Stokta Yok/Non Stock Item
PLBT Ucuna Uygundur. / Compatible with PLBT Insert.

Sipariş Örneği/Ordering Example : 1 ad./pcs. ADKT-WGX24-R-2525-3-T22

DIŞ ÇAP KANAL AÇMA TAKIMLARI EXTERNAL GROOVING TOOLHOLDERS

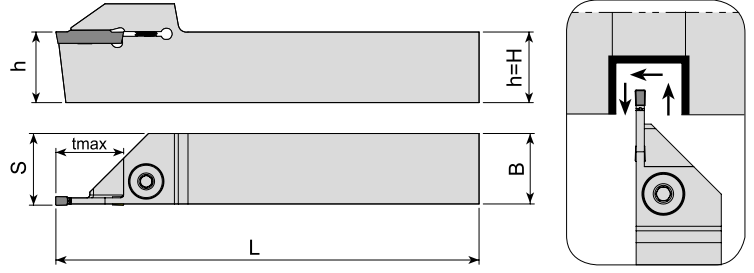

Takım Kodu Ordering Code	Stok Stock		Takım Ölçüleri (mm) Dimension (mm)				Kesici Uç Insert	Yedek Parçaları Spare Parts			
	R	L	h=H	B	L	S		t _{max}	Sıkma Vidası Clamp Screw	Pul Stamp	Anahtar Allen Key
ADKT-CD-R/L-2020-3-R20	●	○	20	20	125	20.3	20				
ADKT-CD-R/L-2525-3-R23	●	○	25	25	150	25.3	23	GX24 0300	2004-M8x1x20	-	AAL-05-4

CRTZT Ucuna Uygundur. / Compatible with CRTZT Insert.

DIŞ ÇAP KANAL AÇMA İSVİÇRE TİPİ KAYAR OTOMAT MAKİNA TAKIMLARI EXTERNAL GROOVING TOOLHOLDERS FOR SWISS TYPE SLIDING AUTOMATIC LATHES

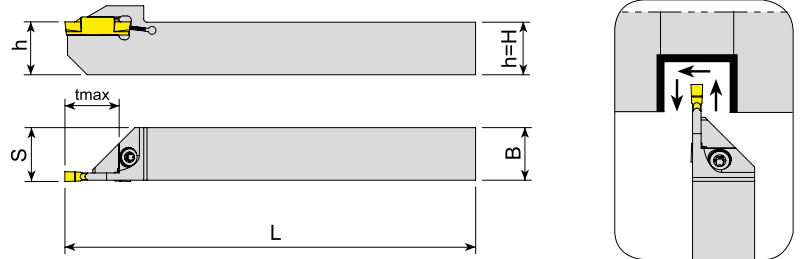

Takım Kodu Ordering Code	Stok Stock		Takım Ölçüleri (mm) Dimension (mm)				Kesici Uç Insert	Yedek Parçaları Spare Parts			
	R	L	h=H	B	L	S		t _{max}	Sıkma Vidası Clamp Screw	Pul Stamp	Tork Anahtar Torx Key
ADKT-TD-R/L-1212-2-T12-K-S	●	●	12	12	125	12.2	12				
ADKT-TD-R/L-1616-2-T16-K-S	●	●	16	16	125	16.2	16	TD.-3	1515-M4x11	-	80-T15
ADKT-TD-R/L-1212-3-T12-K-S	●	●	12	12	125	12.3	12				
ADKT-TD-R/L-1616-3-T16-K-S	●	●	16	16	125	16.3	16				

R: Sağ/Right L: Sol/Left ● Stokta/In Stock ○ Stokta Yok/Non Stock Item
TGTC Ucuna Uygundur. / Compatible with TGTC Insert.

Sipariş Örneği/Ordering Example : 1 ad./pcs. ADKT-CD-R-2020-3-R20



www.akkо.com.tr

Дистрибьютер ООО "Ресурс Плюс"
+7 (351) 247-74-40; info@rp-ural.ru

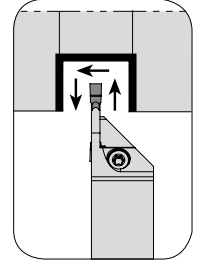
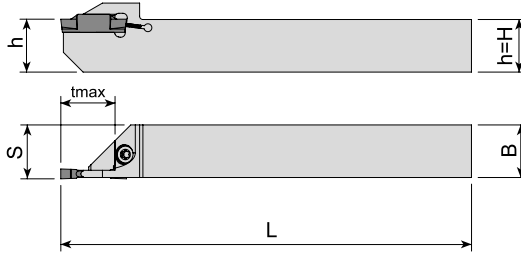

Takım Kodu Ordering Code	Stok Stock		Takım Ölçüleri (mm) Dimension (mm)					Kesici Uç Insert	Yedek Parçaları Spare Parts		
	R	L	h=H	B	L	S	t max		Sıkma Vidası Clamp Screw	Pul Stamp	Tork Anahtar Torx Key
ADKT-ZCC2-R/L-1010-2-T12-K-S	●	●	10	10	125	10.2	12	Z.BD - 2	1515-M4x11	-	80-T15
ADKT-ZCC2-R/L-1212-2-T12-K-S	●	●	12	12	125	12.2	12				
ADKT-ZCC2-R/L-1616-2-R16-K-S	●	●	16	16	125	16.2	16	Z.FD - 3			
ADKT-ZCC2-R/L-1212-3-T12-K-S	●	●	12	12	125	12.3	12				

ZCC Ucuna Uygundur. / Compatible with ZCC Insert.

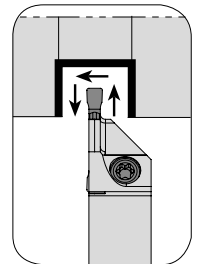
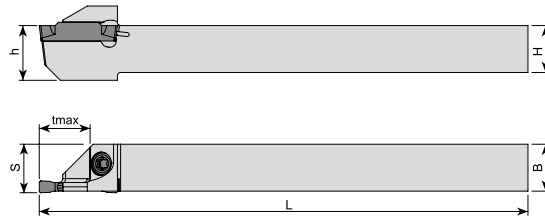

Takım Kodu Ordering Code	Stok Stock		Takım Ölçüleri (mm) Dimension (mm)					Kesici Uç Insert	Yedek Parçaları Spare Parts		
	R	L	h=H	B	L	S	t max		Sıkma Vidası Clamp Screw	Pul Stamp	Tork Anahtar Torx Key
ADKT-KG-R/L-1212-2-R12-K-S	●	●	12	12	125	12.2	12	KG. - 2	1515-M4x11	-	80-T15
ADKT-KG-R/L-1212-3-R12-K-S	●	●	12	12	125	12.4	12	KG. - 3			

R: Sağ/Right L: Sol/Left ● Stokta/In Stock ○ Stokta Yok/Non Stock Item
KRLY Ucuna Uygundur. / Compatible with KRLY Insert.

Sipariş Örneği/Ordering Example : 1 ad./pcs. ADKT-ZCC2-R-1010-2-T12-K-S

DIŞ ÇAP KANAL AÇMA İSVİÇRE TİPİ KAYAR OTOMAT MAKİNA TAKIMLARI
EXTERNAL GROOVING TOOLHOLDERS FOR SWISS TYPE SLIDING AUTOMATIC LATHES

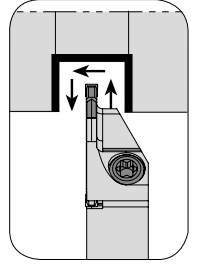
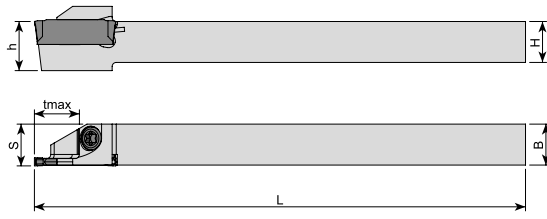

Takım Kodu Ordering Code	Stok Stock		Takım Ölçüleri (mm) Dimension (mm)					Kesici Uç Insert	Yedek Parçaları Spare Parts		
	R	L	h=H	B	L	S	t max		Sıkma Vidası Clamp Screw	Pul Stamp	Tork Anahtar Torx Key
ADKT-I-R/L-0808-2-R10-S	●	●	08	08	100	8.2	10				
ADKT-I-R/L-1010-2-R10-K-S	●	●	10	10	120	10.2	10	DGN - 2	1515-M4x11	-	80-T15
ADKT-I-R/L-1212-2-R12-K-S	●	●	12	12	125	12.2	12				
ADKT-I-R/L-1616-3-R16-S	○	●	16	16	120	16.3	16	DGN - 3	2004-M8x1x20	-	AAL-05-4

ISCR Ucuna Uygundur. / Compatible with ISCR Insert.

DIŞ ÇAP ALIN KANAL AÇMA TAKIMLARI
FACE EXTERNAL GROOVING TOOLHOLDERS

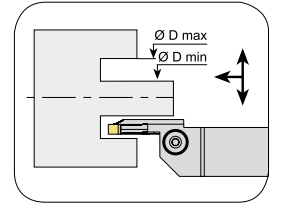
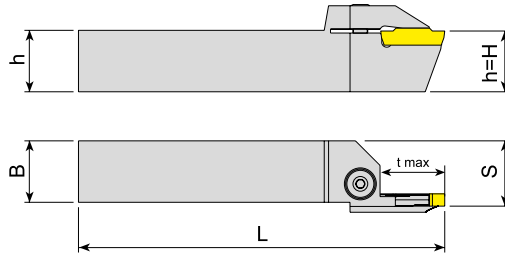

Takım Kodu Ordering Code	Stok Stock		Takım Ölçüleri (mm) Dimension (mm)							Kesici Uç Insert	Yedek Parçaları Spare Parts		
	R	L	h=H	B	L	S	t max	Ø D min	Ø D max		Sıkma Vidası Clamp Screw	Pul Stamp	Anahtar Allen Key
AAKT-KG-R/L-2525-44-70-4-T22	○	○	25	25	150	26.5	22	44	70				
AAKT-KG-R/L-2525-60-120-4-T22	○	○	25	25	150	26.5	22	60	120	KG.. - 4	2004-M8x1x20	-	AAL-05-4
AAKT-KG-R/L-2525-112-200-4-T22	○	○	25	25	150	26.5	22	112	200				

R: Sağ/Right L: Sol/Left ● Stokta/In Stock ○ Stokta Yok/Non Stock Item
KRLY Ucuna Uygundur. / Compatible with KRLY Insert.

Sipariş Örneği/Ordering Example : 1 ad./pcs. ADKT-I-R-0808-2-R10-S

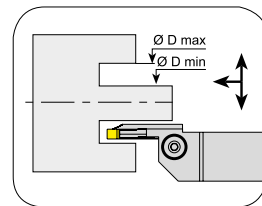
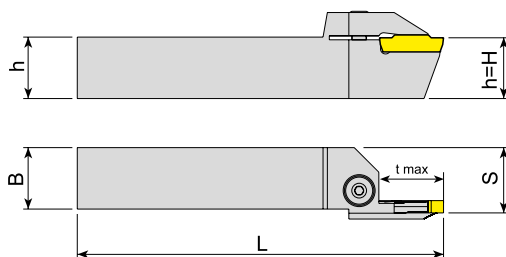

Takım Kodu Ordering Code	Stok Stock		Takım Ölçüleri (mm) Dimension (mm)							Kesici Uç Insert	Yedek Parçaları Spare Parts		
	R	L	h=H	B	L	S	t max	Ø D min	Ø D max		Sıkma Vidası Clamp Screw	Pul Stamp	Anahtar Allen Key
AAKT-K-R/L-2525-34-45-3-T17	●	●	25	25	150	26.5	17	34	45	MGM. - 3			
AAKT-K-R/L-2525-39-55-3-T17	●	●	25	25	150	26.5	17	39	55				
AAKT-K-R/L-2525-49-80-3-T17	●	●	25	25	150	26.5	17	49	80				
AAKT-K-R/L-2525-70-110-3-T17	●	●	25	25	150	26.5	17	70	110				
AAKT-K-R/L-2525-100-150-3-T17	●	●	25	25	150	26.5	17	100	150				
AAKT-K-R/L-2525-80-180-3-T32	●	●	25	25	150	26.5	32	80	180				
AAKT-K-R/L-2525-175-215-3-T22	●	●	25	25	150	26.5	22	175	215	MGM. - 4	2004-M8x1x20	-	AAL-05-4
AAKT-K-R/L-2525-50-85-4-T22	●	●	25	25	150	26.5	22	50	85				
AAKT-K-R/L-2525-70-110-4-T22	●	●	25	25	150	26.5	22	70	110				
AAKT-K-R/L-2525-100-150-4-T22	●	●	25	25	150	26.5	22	100	150				
AAKT-K-R/L-2525-80-180-4-T32	●	●	25	25	150	26.5	32	80	180				
AAKT-K-R/L-2525-180-800-4-T32	●	●	25	25	150	26.5	32	180	800				
AAKT-K-R/L-2525-70-110-5-T25	●	●	25	25	150	26.5	25	70	110	MGM. - 5			
AAKT-K-R/L-2525-100-150-5-T25	●	●	25	25	150	26.5	25	100	150				
AAKT-K-R/L-2525-80-180-5-T32	●	●	25	25	150	26.5	32	80	180				
AAKT-K-R/L-2525-140-200-5-T25	●	●	25	25	150	26.5	25	140	200				
AAKT-K-R/L-2525-180-800-5-T32	●	●	25	25	150	26.5	32	180	800	MGM. - 6			
AAKT-K-R/L-2525-60-100-6-T25	●	●	25	25	150	26.5	25	60	100				
AAKT-K-R/L-2525-60-100-6-T35	●	○	25	25	150	26.5	35	60	100				
AAKT-K-R/L-2525-100-200-6-T25	●	○	25	25	150	26.5	25	100	200				
AAKT-K-R/L-2525-100-200-6-T35	●	○	25	25	150	26.5	35	100	200	MGM. - 8			
AAKT-K-R/L-2525-140-300-6-T35	●	●	25	25	150	26.5	35	140	300				
AAKT-K-R/L-2525-140-300-8-T35	●	○	25	25	150	26.5	35	140	300	MGM. - 8			
AAKT-K-R/L-3232-140-350-8-T35	●	○	32	32	150	33.5	35	140	350				

R: Sağ/Right L: Sol/Left ● Stokta/In Stock ○ Stokta Yok/Non Stock Item
KRLY Ucuna Uygunudur. / Compatiple with KRLY Insert.

Sipariş Örneği/Ordering Example : 1 ad./pcs. AAKT-K-R-2525-34-45-3-T17

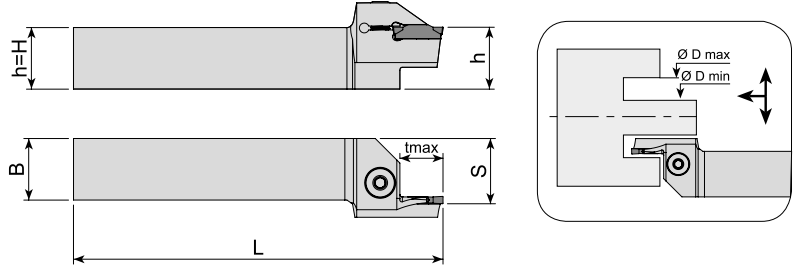

Takım Kodu Ordering Code	Stok Stock		Takım Ölçüleri (mm) Dimension (mm)						Kesici Uç Insert	Yedek Parçaları Spare Parts			
	R	L	h=H	B	L	S	t max	Ø D min		Ø D max	Sıkma Vidası Clamp Screw	Pul Stamp	Anahtar Allen Key
AAKT-ZCC2-R/L-2525-140-180-2-T4	●	○	25	25	150	26.5	4	140	180	Z.BD - 2	2004-M8x1x20	-	AAL-05-4
AAKT-ZCC2-R/L-2525-35-45-3-T17	●	●	25	25	150	26.5	17	35	45	Z.FD - 3			
AAKT-ZCC2-R/L-2525-39-55-3-T17	●	○	25	25	150	26.5	17	39	55				
AAKT-ZCC2-R/L-2525-49-80-3-T17	●	●	25	25	150	26.5	17	49	80				
AAKT-ZCC2-R/L-2525-70-110-3-T17	●	●	25	25	150	26.5	17	70	110	Z.GD - 4			
AAKT-ZCC2-R/L-2525-100-150-3-T17	●	○	25	25	150	26.5	17	100	150				
AAKT-ZCC2-R/L-2525-40-60-4-T22	●	○	25	25	150	26.5	22	40	60				
AAKT-ZCC2-R/L-2525-52-80-4-T22	●	●	25	25	150	26.5	22	52	80				
AAKT-ZCC2-R/L-2525-72-110-4-T22	●	●	25	25	150	26.5	22	72	110	Z.HD - 5			
AAKT-ZCC2-R/L-2525-100-150-4-T22	●	●	25	25	150	26.5	22	100	150				
AAKT-ZCC2-R/L-2525-140-200-4-T22	●	●	25	25	150	26.5	22	140	200				
AAKT-ZCC2-R/L-2525-55-95-5-T25	●	○	25	25	150	26.5	25	55	95	Z.KD - 6			
AAKT-ZCC2-R/L-2525-85-140-5-T25	●	●	25	25	150	26.5	25	85	140				
AAKT-ZCC2-R/L-2525-130-200-5-T25	●	○	25	25	150	26.5	25	130	200				
AAKT-ZCC2-R/L-2525-190-400-5-T25	●	●	25	25	150	26.5	25	190	400				
AAKT-ZCC2-R/L-2525-200-500-5-T17	●	●	25	25	150	26.5	25	200	500				
AAKT-ZCC2-R/L-2525-60-110-6-T15	●	○	25	25	150	26.5	15	60	110				

R: Sağ/Right L: Sol/Left ● Stokta/In Stock ○ Stokta Yok/Non Stock Item
ZCC Ucuna Uygundur. / Compatible with ZCC Insert.

Sipariş Örneği/Ordering Example : 1 ad./pcs. AAKT-ZCC2-R-2525-140-180-2-T4



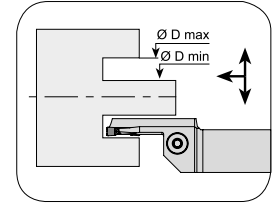
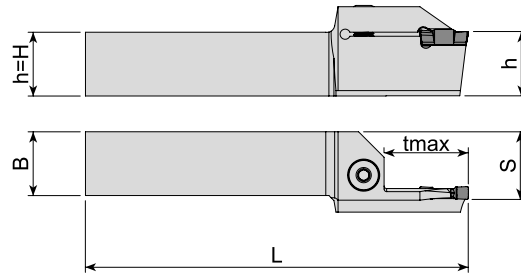

Takım Kodu Ordering Code	Stok Stock		Takım Ölçüleri (mm) Dimension (mm)							Kesici Uç Insert	Yedek Parçaları Spare Parts		
	R	L	h=H	B	L	S	t max	Ø D min	Ø D max		Sıkma Vidası Clamp Screw	Pul Stamp	Anahtar Allen Key
AAKT-IG-R/L-2525-40-60-4-T25	●	○	25	25	150	26.5	25	40	60	DGN / GRP - 4	2004-M8x1x20	-	AAL-05-4
AAKT-IG-R/L-2525-52-80-4-T25	●	●	25	25	150	26.5	25	52	80				
AAKT-IG-R/L-2525-70-110-4-T28	●	●	25	25	150	26.5	28	70	110				
AAKT-IG-R/L-2525-72-110-4-T25	○	○	25	25	150	26.5	25	72	110				
AAKT-IG-R/L-2525-100-150-4-T25	○	○	25	25	150	26.5	25	100	150				
AAKT-IG-R/L-2525-110-200-4-T28	●	○	25	25	150	26.5	28	110	200				
AAKT-IG-R/L-2525-110-200-4-T32	●	●	25	25	150	26.5	32	110	200				
AAKT-IG-R/L-2525-140-200-4-T25	○	○	25	25	150	26.5	25	140	200				
AAKT-IG-R/L-2525-180-800-4-T28	●	●	25	25	150	26.5	28	180	800				
AAKT-IG-R/L-2525-200-800-4-T25	○	○	25	25	150	26.5	25	200	800				
AAKT-IG-R/L-2525-70-110-5-T32	●	○	25	25	150	26.5	32	70	110	DGN / GRP - 5			
AAKT-IG-R/L-2525-110-200-5-T32	●	●	25	25	150	26.5	32	110	200				
AAKT-IG-R/L-2525-180-800-5-T32	●	●	25	25	150	26.5	32	180	800				
AAKT-IG-R/L-2525-58-100-6-T32	●	○	25	25	150	26.5	32	58	100	DGN / GRP - 6			
AAKT-IG-R/L-2525-88-180-6-T32	●	○	25	25	150	26.5	32	88	180				

R: Sağ/Right L: Sol/Left ● Stokta/In Stock ○ Stokta Yok/Non Stock Item
ISCR Ucuna Uygunudur. / Compatiple with ISCR Insert.

Sipariş Örneği/Ordering Example : 1 ad./pcs. AAKT-IG-R-2525-40-60-4-T25



➤ L TİP ALIN KANAL AÇMA TAKIMLARI
L TYPE FACE EXTERNAL GROOVING TOOLHOLDERS

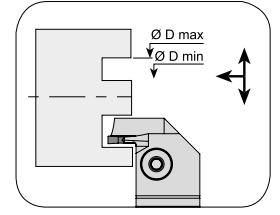
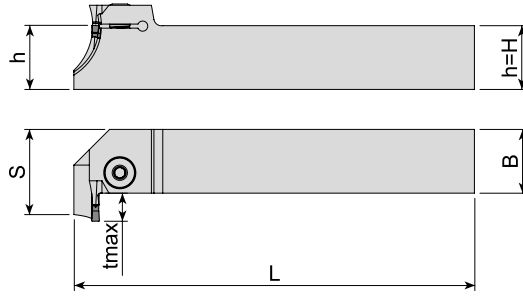

Takım Kodu Ordering Code	Stok Stock		Takım Ölçüleri (mm) Dimension (mm)							Kesici Uç Insert	Yedek Parçaları Spare Parts		
	R	L	h=H	B	L	S	t max	Ø D min	Ø D max		Sıkma Vidası Clamp Screw	Pul Stamp	Anahtar Allen Key
ALKT-ZCC2-R/L-2525-35-45-3-T10	●	○	25	25	150	36	10	35	45	Z.FD - 3	2004-M8x1x20	-	AAL-05-4
ALKT-ZCC2-R/L-2525-39-55-3-T10	●	○	25	25	150	36	10	39	55				
ALKT-ZCC2-R/L-2525-35-∞-3-T4	●	●	25	25	150	30	4	35	∞				
ALKT-ZCC2-R/L-2525-40-60-4-T14	●	○	25	25	150	40	14	40	60				
ALKT-ZCC2-R/L-2525-52-80-4-T14	●	○	25	25	150	40	14	52	80				
ALKT-ZCC2-R/L-2525-72-110-4-T14	●	○	25	25	150	40	14	72	110				
ALKT-ZCC2-R/L-2525-100-230-4-T14	●	○	25	25	150	40	14	100	230				
ALKT-ZCC2-R/L-2525-40-∞-4-T4	●	○	25	25	150	30	4	40	∞				

ZCC Ucuna Uygundur. / Compatible with ZCC Insert.

➤ KESME VE DERİN KANAL AÇMA LAMALARI
BLADES FOR PARTING AND DEEP GROOVING

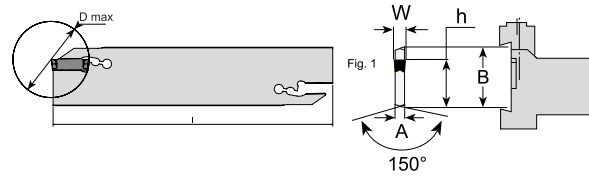
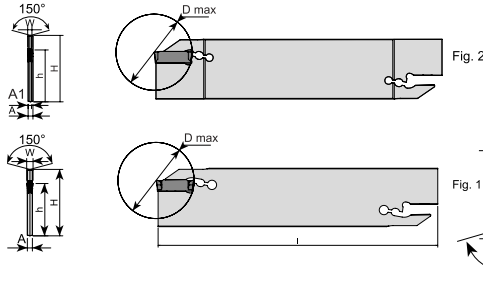

Takım Kodu Ordering Code	Stok Stock	Takım Ölçüleri (mm) Dimension (mm)							Kesici Uç Insert	Yedek Parçaları Spare Parts	
		B	W	A	A1	l	h	D max		Fig.	Anahtar Key
AKL-I-26-2	●	26	1.9-2.5	1.6	-	110	21.4	39	1	DGN - 2	ALA-01
AKL-I-32-2	●	32	1.9-2.5	2.4	1.8	150	25	39	2		
AKL-I-26-3	●	26	3-3.18	2.4	-	110	21.4	39	1		
AKL-I-32-3	●	32	3-3.18	2.4	-	150	25	39	1		
AKL-I-26-4	●	26	4	3.2	-	110	21.4	80	1		
AKL-I-32-4	●	32	4	3.2	-	150	25	100	1		
										DGN / GRP - 4	

R: Sağ/Right L: Sol/Left ● Stokta/In Stock ○ Stokta Yok/Non Stock Item
ISCR Ucuna Uygundur. / Compatible with ISCR Insert.

Sipariş Örneği/Ordering Example : 1 ad./pcs. ALKT-ZCC2-R-2525-35-45-3-T10



www.akko.com.tr

Дистрибьютер ООО "Ресурс Плюс"
+7 (351) 247-74-40; info@rp-ural.ru

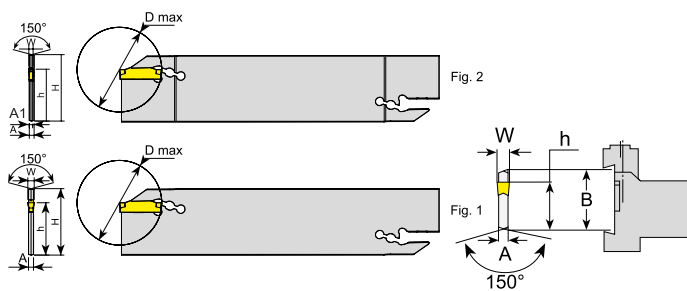

Takım Kodu Ordering Code	Stok Stock	Takım Ölçüleri (mm) Dimension (mm)								Kesici Uç Insert	Yedek Parçaları Spare Parts	
		B	W	A	A1	l	h	D max	Fig.		Anahtar Key	
AKL-123-32-3	●	32	3	2.4	-	150	25	39	1		ALA-01	
AKL-123-32-4	●	32	4	3.2	-	150	25	39	1			

SNDVK Ucuna Uygunudur. / Compatiple with SNDVK Insert.

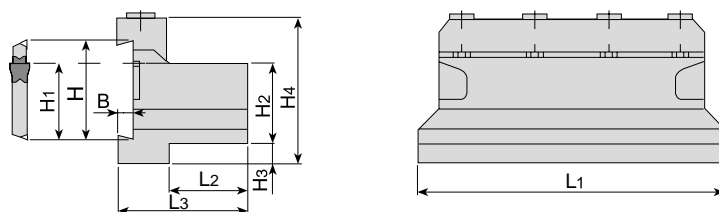

Takım Kodu Ordering Code	Stok Stock	Takım Ölçüleri (mm) Dimension (mm)									Yedek Parçaları Spare Parts		
		H	H1	H2	H3	H4	B	L1	L2	L3	Pabuç Clamp	Pabuç Vidası Clamp Screw	Anahtar Allen Key
ALBU-20-26	●	26	21.4	20	8	38	4	87	19	33		2505-M6x25	
ALBU-25-26	●	26	21.4	25	3	38	4	110	20	34			
ALBU-20-32	●	32	25	20	13	48	5.5	100	19	35		2505-M6x30	AAL-07-5
ALBU-25-32	●	32	25	25	8	48	5.5	110	20	36			
ALBU-32-32	●	32	25	32	3	48	5.5	120	28	44			

R: Sağ/Right L: Sol/Left ● Stokta/In Stock ○ Stokta Yok/Non Stock Item

Sipariş Örneği/Ordering Example : 1 ad./pcs. AKL-123-32-3

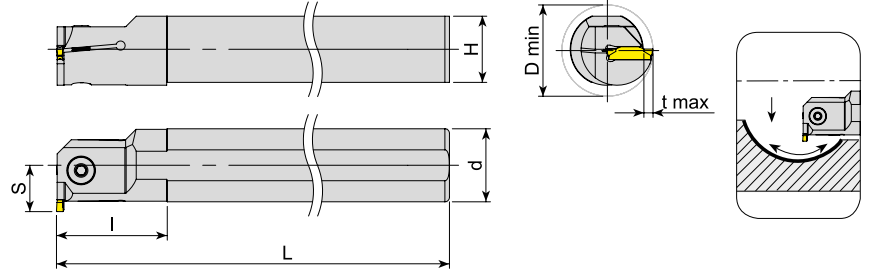

Takım Kodu Ordering Code	Stok Stock		Takım Ölçüleri (mm) Dimension (mm)							Kesici Uç Insert	Yedek Parçaları Spare Parts	
	R	L	d	D min	L	l	t max	H	S		Sıkma Vidası Clamp Screw	Anahtar Allen Key
AIKT-K-R/L-16-2-T4	●	●	16	21	150	28	4	14.8	12	MGM. - 2	2503-M4x10	AAL-03-3
AIKT-K-R/L-20-2-T4	●	●	20	25	170	30	4	18.3	14		2503-M4x12	
AIKT-K-R/L-25-2-T6	●	●	25	32	200	40	6	23	18.5		2504-M5x12	
AIKT-K-R/L-20-3-T6	●	●	20	27	170	30	6	18.3	16	MGM. - 3	2504-M5x12	AAL-05-4
AIKT-K-R/L-20-3-T7	●	●	20	25	170	38	7	18.3	13		2504-M5x12	
AIKT-K-R/L-25-3-T6	●	●	25	32	200	40	6	23	18.5		2504-M5x16	
AIKT-K-R/L-25-3-T10	●	●	25	32	200	48	10	23	17		2004-M8x1x20	
AIKT-K-R/L-32-3-T6	●	●	32	39	250	50	6	30	22		2504-M5x12	
AIKT-K-R/L-32-3-T12	●	●	32	39	250	53	12	30	22		2504-M5x16	
AIKT-K-R/L-40-3-T6	●	●	40	47	300	55	6	37.5	26		2004-M8x1x20	
AIKT-K-R/L-40-3-T12	●	○	40	48	300	63	12	37.5	27		2504-M5x12	
AIKT-K-R/L-20-4-T6	●	●	20	27	170	30	6	18.3	16		MGM. - 4	
AIKT-K-R/L-20-4-T7	●	○	20	25	170	38	7	18.3	13	2504-M5x16		
AIKT-K-R/L-25-4-T6	●	●	25	32	200	40	6	23	18.5	2504-M5x16		
AIKT-K-R/L-25-4-T10	●	●	25	32	200	49	10	23	17	2004-M8x1x20		
AIKT-K-R/L-32-4-T6	●	●	32	39	250	50	6	30	22	2504-M5x12		
AIKT-K-R/L-32-4-T12	●	●	32	39	250	53	12	30	22	2504-M5x16		
AIKT-K-R/L-40-4-T6	●	●	40	47	300	55	6	37.5	26	2004-M8x1x20		
AIKT-K-R/L-40-4-T12	●	●	40	48	300	63	12	37.5	27	2504-M5x16		
AIKT-K-R/L-25-5-T7	●	●	25	33	200	40	7	23	19.5	MGM. - 5		2504-M5x16
AIKT-K-R/L-32-5-T7	●	●	32	40	250	50	7	30	23		2004-M8x1x20	
AIKT-K-R/L-40-5-T7	●	●	40	48	300	55	7	37.5	27		2004-M8x1x20	

R: Sağ/Right L: Sol/Left ● Stokta/In Stock ○ Stokta Yok/Non Stock Item
KRLY Ucuna Uygunudur. / Compatiple with KRLY Insert.

Sipariş Örneği/Ordering Example : 1 ad./pcs. AIKT-K-R-16-2-T4

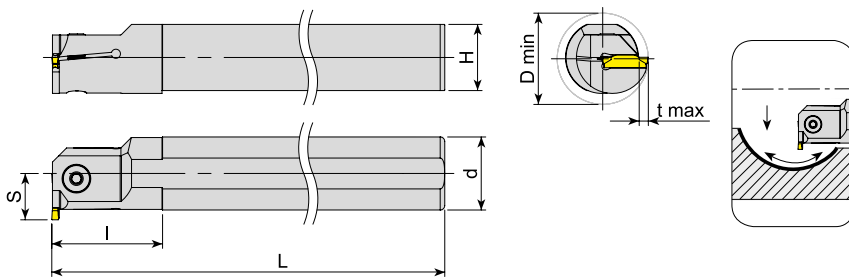

Takım Kodu Ordering Code	Stok Stock		Takım Ölçüleri (mm) Dimension (mm)							Kesici Uç Insert	Yedek Parçaları Spare Parts	
	R	L	d	D min	L	I	t max	H	S		Sıkma Vidası Clamp Screw	Anahtar Allen Key
AIKT-KG-R/L-25-2-T7	●	●	25	33	200	40	7	23	19.5	KG.. - 2	2504-M5x12	AAL-05-4
AIKT-KG-R/L-25-3-T7	○	○	25	33	200	40	7	23	19.5			
AIKT-KG-R/L-40-3-T8	●	○	40	50	300	55	8	37.5	28	KG.. - 3	2504-M5x16	AAL-05-4
AIKT-KG-R/L-25-4-T8	●	●	25	34	200	40	8	23	20.5			

KRLY Ucuna Uygundur. / Compatible with KRLY Insert.

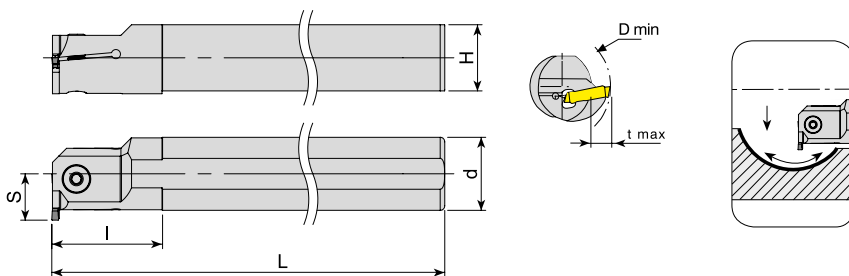

Takım Kodu Ordering Code	Stok Stock		Takım Ölçüleri (mm) Dimension (mm)							Kesici Uç Insert	Yedek Parçaları Spare Parts	
	R	L	d	D min	L	I	t max	H	S		Sıkma Vidası Clamp Screw	Anahtar Allen Key
AIKT-H-R/L-25-3-T8	●	●	25	34	200	40	8	23	20.5	S229 - 3	2504-M5x16	AAL-05-4
AIKT-H-R/L-32-3-T7	●	●	32	40	250	50	7	30	23			
AIKT-H-R/L-40-3-T7	●	●	40	48	300	55	7	37.5	27			
AIKT-H-R/L-25-4-T8	●	●	25	34	200	40	8	23	20.5	S229 - 4	2504-M5x16	AAL-05-4
AIKT-H-R/L-32-4-T7	●	●	32	40	250	50	7	30	23			
AIKT-H-R/L-40-4-T7	●	○	40	48	300	55	7	37.5	27			
AIKT-H-R/L-25-5-T8	●	●	25	34	200	40	8	23	20.5	S229 - 5	2504-M5x16	AAL-05-4
AIKT-H-R/L-32-5-T7	●	○	32	40	250	50	7	30	23			
AIKT-H-R/L-40-5-T7	●	○	40	48	300	55	7	37.5	27			

R: Sağ/Right L: Sol/Left ● Stokta/In Stock ○ Stokta Yok/Non Stock Item
HRN Ucuna Uygundur. / Compatible with HRN Insert.

Sipariş Örneği/Ordering Example : 1 ad./pcs. AIKT-KG-R-25-2-T7

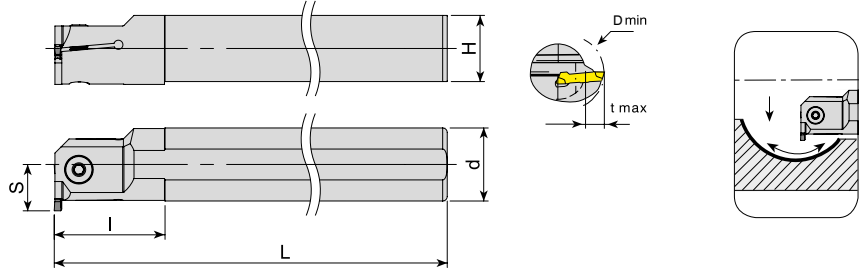

Takım Kodu Ordering Code	Stok Stock		Takım Ölçüleri (mm) Dimension (mm)							Kesici Uç Insert	Yedek Parçaları Spare Parts	
	R	L	d	D min	L	l	t max	H	S		Sıkma Vidası Clamp Screw	Anahtar Allen Key
AIKT-HK-R/L-20-2-T6	●	○	20	26	170	30	6	18.3	16	S224 - 2	2503-M4x12	AAL-03-3
AIKT-HK-R/L-25-2-T6	●	○	25	32	200	40	6	23	18.5		2504-M5x16	
AIKT-HK-R/L-20-3-T6	●	○	20	27	170	30	6	18.3	16	S224 - 3	2504-M5x12	AAL-05-4
AIKT-HK-R/L-25-3-T6	●	○	25	32	200	40	6	23	18.5		2504-M5x16	
AIKT-HK-R/L-32-3-T6	●	○	32	39	250	50	6	30	22	S224 - 4	2004-M8x1x20	AAL-05-4
AIKT-HK-R/L-20-4-T6	●	○	20	27	170	30	6	18.3	16		2504-M5x12	
AIKT-HK-R/L-25-4-T6	●	○	25	32	200	40	6	23	18.5	S224 - 4	2504-M5x16	AAL-05-4
AIKT-HK-R/L-32-4-T6	●	○	32	39	250	50	6	30	22		2004-M8x1x20	
AIKT-HS223-R/L-20-2-T5	●	○	20	26	170	33	5	18.3	15	S223 - 2	2503-M4x12	AAL-03-3
AIKT-HS223-R/L-25-2-T5	●	○	25	31	200	40	5	23	17.5		2504-M5x16	
AIKT-HS223-R/L-20-3-T6	●	○	20	27	170	33	6	18.3	16	S223 - 3	2504-M5x12	AAL-05-4
AIKT-HS223-R/L-25-3-T6	●	○	25	32	200	40	6	23	18.5		2504-M5x16	

HRN Ucuna Uygun. / Compatible with HRN Insert.

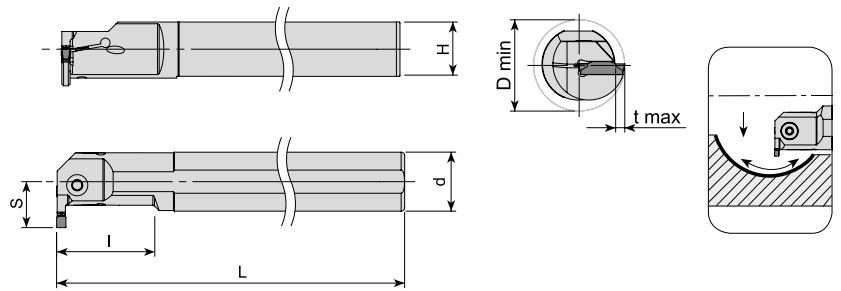

Takım Kodu Ordering Code	Stok Stock		Takım Ölçüleri (mm) Dimension (mm)							Kesici Uç Insert	Yedek Parçaları Spare Parts	
	R	L	d	D min	L	l	t max	H	S		Sıkma Vidası Clamp Screw	Anahtar Allen Key
AIKT-KM-R/L-20-2-T7	●	○	20	25	170	40	7	18.3	13	A4. - 2	2503-M4x12	AAL-03-3
AIKT-KM-R/L-20-3-T7	●	○	20	25	170	40	7	18.3	13		2504-M5x12	
AIKT-KM-R/L-25-3-T10	●	○	25	32	200	50	10	23	17	A4. - 3	2505-M6x16	AAL-07-5
AIKT-KM-R/L-32-3-T12	●	○	32	40	250	64	12	30	22		2505-M6x20	
AIKT-KM-R/L-40-3-T12	●	○	40	48	300	80	12	37.5	27	A4. - 4	2504-M5x12	AAL-05-4
AIKT-KM-R/L-20-4-T7	●	○	20	25	170	40	7	18.3	13		2504-M5x12	

R: Sağ/Right L: Sol/Left ● Stokta/In Stock ○ Stokta Yok/Non Stock Item

KNMTL Ucuna Uygun. / Compatible with KNMTL Insert.

Sipariş Örneği/Ordering Example : 1 ad./pcs. AIKT-HK-R-20-2-T6

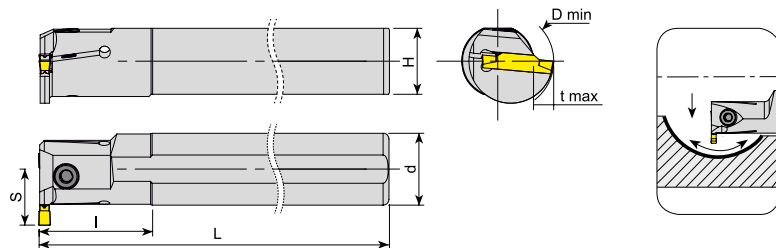

Takım Kodu Ordering Code	Stok Stock		Takım Ölçüleri (mm) Dimension (mm)							Kesici Uç Insert	Yedek Parçaları Spare Parts		
	R	L	d	D _{min}	L	l	t _{max}	H	S		Sıkma Vidası Clamp Screw	Anahtar Allen Key	
AIKT-123-R/L-32-2-T7	●	○	32	41	250	45	7	30	23	123 - 2	2004-M8x1x20	AAL-05-4	
AIKT-123-R/L-20-3-T6	●	○	20	32	170	30	6	18.3	16		2504-M5x16		
AIKT-123-R/L-25-3-T7	●	○	25	32	200	40	7	23	19.5	123 - 3	2004-M8x1x20		
AIKT-123-R/L-32-3-T9	●	○	32	41	250	50	9	30	25		2504-M5x16		
AIKT-123-R/L-20-4-T8	●	○	20	29	170	30	8	18.3	18	123 - 4	2504-M5x16		
AIKT-123-R/L-25-4-T7	●	○	25	32	200	40	7	23	19.5		2004-M8x1x20		
AIKT-123-R/L-32-4-T7	●	○	32	41	250	45	7	30	23	123 - 5	2504-M5x16		
AIKT-123-R/L-32-4-T10	●	○	32	43	250	50	10	30	26		2004-M8x1x20		
AIKT-123-R/L-25-5-T8	●	○	25	34	200	40	8	23	20.5	2504-M5x16			
AIKT-123-R/L-32-5-T11	●	○	32	43	250	50	11	30	27	2004-M8x1x20			

SNDVK Ucuna Uygundur. / Compatible with SNDVK Insert.

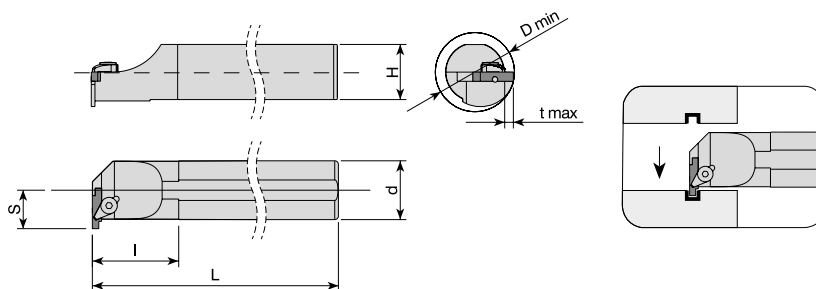

Takım Kodu Ordering Code	Stok Stock		Takım Ölçüleri (mm) Dimension (mm)							Kesici Uç Insert	Yedek Parçaları Spare Parts			
	R	L	d	D _{min}	L	l	t _{max}	H	S		Baskı Parçası Wedge Clamp	Sıkma Vidası Clamp Screw	Pim Pin	Anahtar Allen Key
AIKT-154.91-R/L-16-3-T3	●	●	16	20	150	35	3	14.8	11	154.91 - 3	ACK-06	AKV-10-M6x14	APM-06	AAL-05-4
AIKT-154.91-R/L-20-3-T4	●	●	20	25	170	38	4	18.3	14		ACK-03	AKV-21-M6x18		
AIKT-154.91-R/L-25-3-T4	●	●	25	31	200	40	4	23	16.5	154.91 - 5	ACK-03	AKV-07-M6x22		
AIKT-154.91-R/L-25-5-T5	●	●	25	31	200	45	5	23	17.5					
AIKT-154.91-R/L-32-5-T5	●	●	32	38	250	50	5	30	21					

R: Sağ/Right L: Sol/Left ● Stokta/In Stock ○ Stokta Yok/Non Stock Item
SNDVK Ucuna Uygundur. / Compatible with SNDVK Insert.

Sipariş Örneği/Ordering Example : 1 ad./pcs. AIKT-123-R-32-2-T7

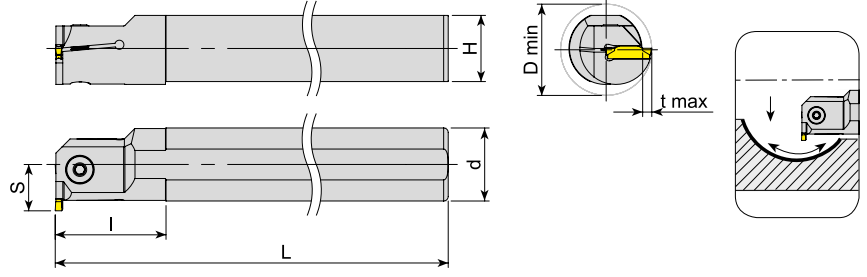

Takım Kodu Ordering Code	Stok Stock		Takım Ölçüleri (mm) Dimension (mm)							Kesici Uç Insert	Yedek Parçaları Spare Parts	
	R	L	d	D min	L	l	t max	H	S		Sıkma Vidası Clamp Screw	Anahtar Allen Key
AIKT-ZCC2-R/L-16-2-T4	●	○	16	21	150	28	4	14.8	12	Z.BD - 2	2503-M4x10	AAL-03-3
AIKT-ZCC2-R/L-20-3-T5	●	●	20	27	170	30	5	18.3	15		Z.FD - 3	
AIKT-ZCC2-R/L-25-3-T5	●	○	25	31	200	40	5	23	17.5	2504-M5x16		
AIKT-ZCC2-R/L-32-3-T6	●	○	32	39	250	50	6	30	22	2004-M8x1x20		
AIKT-ZCC2-R/L-32-3-T8	●	○	32	41	250	50	8	30	24	Z.GD - 4	2504-M5x16	AAL-05-4
AIKT-ZCC2-R/L-25-4-T6	●	○	25	32	200	40	6	23	18.5			
AIKT-ZCC2-R/L-32-4-T7	●	○	32	40	250	50	7	30	23			
AIKT-ZCC2-R/L-32-4-T8	●	○	32	41	250	50	8	30	24	Z.HD - 5	2004-M8x1x20	
AIKT-ZCC2-R/L-32-4-T10	●	○	32	43	250	50	10	30	26			
AIKT-ZCC2-R/L-32-5-T7	●	○	32	40	250	50	7	30	23			
AIKT-ZCC2-R/L-32-5-T8	●	○	32	41	250	50	8	30	24			
AIKT-ZCC2-R/L-40-5-T8	●	○	40	49	300	55	8	37.5	28			
AIKT-ZCC2-R/L-40-5-T10	●	○	40	51	300	55	10	37.5	30			

ZCC Ucuna Uygundur. / Compatible with ZCC Insert.

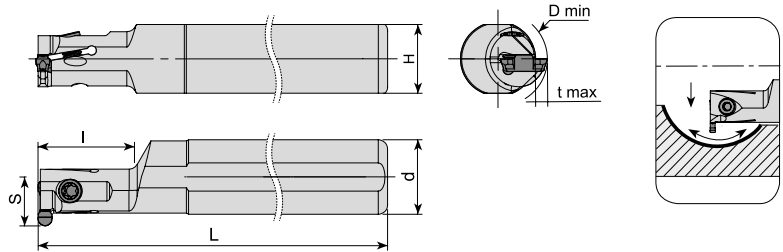

Takım Kodu Ordering Code	Stok Stock		Takım Ölçüleri (mm) Dimension (mm)							Kesici Uç Insert	Yedek Parçaları Spare Parts	
	R	L	d	D min	L	l	t max	H	S		Sıkma Vidası Clamp Screw	Anahtar Allen Key
AIKT-IGE-R/L-16-2-T2.5-H	●	○	16	13	125	20	2.5	14.8	10.5	GEPI - 2	1315-M4x11	80-T15
AIKT-IGE-R/L-16-3-T2.5-H	●	○	16	13	125	20	2.5	14.8	10.5			

R: Sağ/Right L: Sol/Left ● Stokta/In Stock ○ Stokta Yok/Non Stock Item
ISCR Ucuna Uygundur. / Compatible with ISCR Insert.

Sipariş Örneği/Ordering Example : 1 ad./pcs. AIKT-ZCC-R-20-3-T5

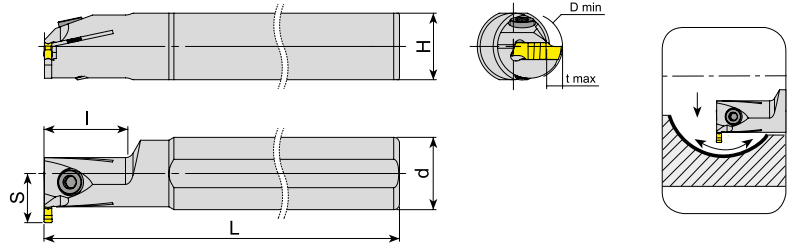

Takım Kodu Ordering Code	Stok Stock		Takım Ölçüleri (mm) Dimension (mm)							Kesici Uç Insert	Yedek Parçaları Spare Parts	
	R	L	d	D min	L	l	t max	H	S		Sıkma Vidası Clamp Screw	Anahtar Key
AIKT-IGI-R/L-20-3-T4	●	●	20	20	170	25	4	18.3	14.5	GIMIY / GIPI - 3	1020-M5x14	80-T20
AIKT-IGI-R/L-25-3-T5	●	●	25	23	200	30	5	23	17		2504-M5x16	AAL-05-4
AIKT-IGI-R/L-32-3-T5	●	●	32	31	250	30	5	30	21	GIMIY / GIPI - 4	2004-M8x1x20	80-T20
AIKT-IGI-R/L-20-4-T4	●	●	20	20	170	25	4	18.3	14.5		1020-M5x14	80-T20

ISCR Ucuna Uygundur. / Compatiple with ISCR Insert.

Not: "l" boyunu D min çapa göre verilmiştir.
Note: Lengths of "l" are given according to D min diameter.

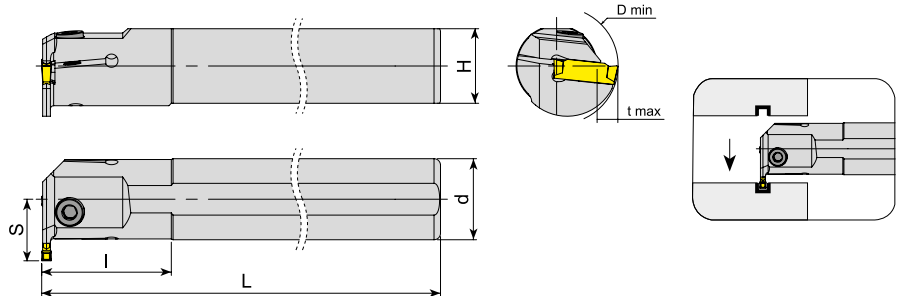

Takım Kodu Ordering Code	Stok Stock		Takım Ölçüleri (mm) Dimension (mm)							Kesici Uç Insert	Yedek Parçaları Spare Parts	
	R	L	d	D min	L	l	t max	H	S		Sıkma Vidası Clamp Screw	Anahtar Allen Key
AIKT-I-R/L-20-3-T5	●	○	20	26	170	25	5	18.3	15.5	DGN - 3	2504-M5x12	AAL-05-4
AIKT-I-R/L-25-3-T6	●	○	25	32	200	40	6	23	19		2504-M5x16	AAL-05-4

R: Sağ/Right L: Sol/Left ● Stokta/In Stock ○ Stokta Yok/Non Stock Item
ISCR Ucuna Uygundur. / Compatiple with ISCR Insert.

Sipariş Örneği/Ordering Example : 1 ad./pcs. AIKT-IGI-R-20-3-T4

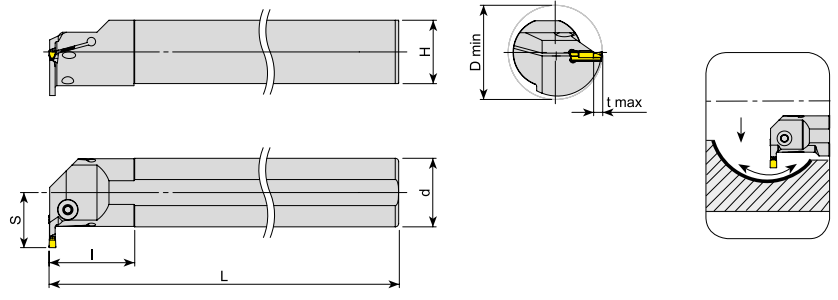

Takım Kodu Ordering Code	Stok Stock		Takım Ölçüleri (mm) Dimension (mm)							Kesici Uç Insert	Yedek Parçaları Spare Parts	
	R	L	d	D min	L	l	t max	H	S		Sıkma Vidası Clamp Screw	Anahtar Allen Key
AIKT-IG-R/L-25-4-T10-H	●	●	25	36	200	40	10	23	22.7	DGN / GRP - 4	2504-M5X16	AAL-05-4
AIKT-IG-R/L-32-4-T10-H	●	●	32	43	250	45	10	30	26.2		2004-M8x1x20	
AIKT-IG-R/L-40-4-T12-H	●	●	40	53	300	50	12	37.5	32.2		2504-M5X16	
AIKT-IG-R/L-25-5-T10-H	●	○	25	36	200	40	10	23	22.7	DGN / GRP - 5	2504-M5X16	
AIKT-IG-R/L-32-5-T10-H	●	○	32	43	250	45	10	30	26.2		2004-M8x1x20	
AIKT-IG-R/L-40-5-T12-H	●	○	40	53	300	50	12	37.5	32.2			
AIKT-IG-R/L-50-5-T12-H	●	○	50	63	350	60	12	47	37.2			

ISCR Ucuna Uygunudur. / Compatible with ISCR Insert.

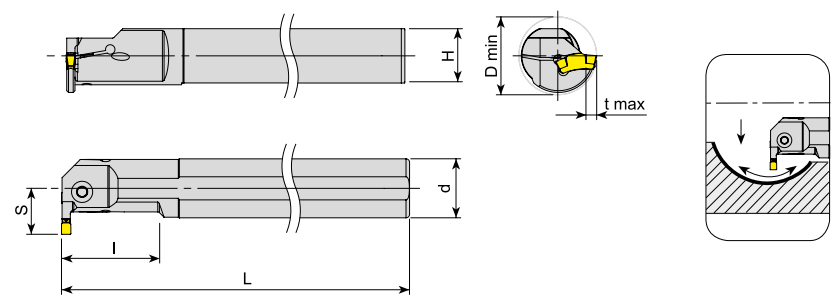

Takım Kodu Ordering Code	Stok Stock		Takım Ölçüleri (mm) Dimension (mm)							Kesici Uç Insert	Yedek Parçaları Spare Parts	
	R	L	d	D min	L	l	t max	H	S		Sıkma Vidası Clamp Screw	Anahtar Key
AIKT-ITG-R/L-16-3-T6-H	●	●	16	20	150	25	6	14.8	12	TGM. - 3	1020-M4.5X14	80-T20
AIKT-ITG-R/L-20-3-T6-H	●	●	20	25	170	32	6	18.3	14.2		1020-M4.5X16	
AIKT-ITG-R/L-25-3-T8-H	●	●	25	32	200	40	8	23	18.8		2504-M5X16	AAL-05-4
AIKT-ITG-R/L-32-3-T8-H	●	●	32	38	250	49	8	30	22	2004-M8x1x20		
AIKT-ITG-R/L-20-4-T6-H	●	●	20	25	170	33	6	18.3	14.2	TGM. - 4	1020-M4.5X16	80-T20
AIKT-ITG-R/L-25-4-T7-H	●	●	25	31	200	41	7	23	17.5		2504-M5X16	AAL-05-4
AIKT-ITG-R/L-25-4-T9-H	●	●	25	32.5	200	41	9	23	19.5			
AIKT-ITG-R/L-32-4-T11-H	●	●	32	42	250	50	11	30	25.5		2004-M8x1x20	
AIKT-ITG-R/L-40-4-T11-H	●	●	40	53	300	50	11	37.5	32			

R: Sağ/Right L: Sol/Left ● Stokta/In Stock ○ Stokta Yok/Non Stock Item
ISCR Ucuna Uygunudur. / Compatible with ISCR Insert.

Sipariş Örneği/Ordering Example : 1 ad./pcs. AIKT-IG-R-25-4-T10-H

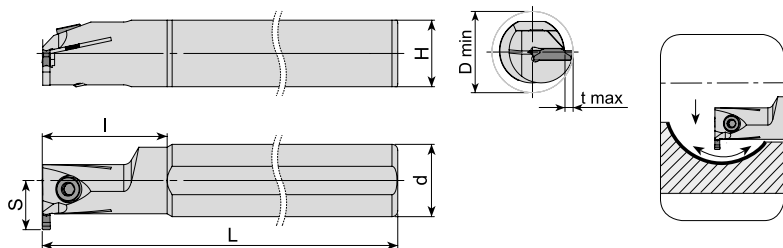

Takım Kodu Ordering Code	Stok Stock		Takım Ölçüleri (mm) Dimension (mm)							Kesici Uç Insert	Yedek Parçaları Spare Parts	
	R	L	d	D min	L	l	t max	H	S		Sıkma Vidası Clamp Screw	Anahtar Allen Key
AIKT-GP-R/L-20-2-T4	●	○	20	25	170	30	4	18.3	14.5	GP - 2	2503-M4x12	AAL-03-3
AIKT-GP-R/L-20-3-T6	●	○	20	27	170	30	6	18.3	16			
AIKT-GP-R/L-25-3-T6	●	○	25	32	200	40	6	23	18.5	GP - 3	2504-M5x16	AAL-05-4
AIKT-GP-R/L-32-3-T6	●	○	32	39	250	50	6	30	22			
AIKT-GP-R/L-20-4-T6	●	○	20	27	170	30	6	18.3	16	GP - 4	2504-M5x16	AAL-05-4
AIKT-GP-R/L-25-4-T6	●	○	25	32	200	40	6	23	18.5			
AIKT-GP-R/L-32-4-T6	●	○	32	39	250	50	6	30	22			

PLBT Ucuna Uygundur. / Compatible with PLBT Insert.

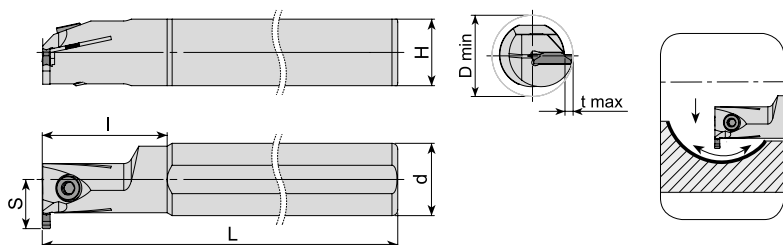



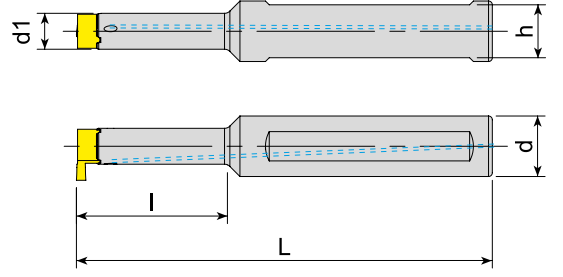

Takım Kodu Ordering Code	Stok Stock		Takım Ölçüleri (mm) Dimension (mm)							Kesici Uç Insert	Yedek Parçaları Spare Parts	
	R	L	d	D min	L	l	t max	H	S		Sıkma Vidası Clamp Screw	Anahtar Allen Key
AIKT-SGC-R-25-3-T6	●	○	25	32	200	40	6	23	18.5	GCM N30	2504-M5x16	AAL-05-4
AIKT-SGC-R-32-3-T6	●	○	32	39	250	50	6	30	22			
AIKT-SGC-R-40-3-T6	●	○	40	47	300	55	6	37.5	26			

R: Sağ/Right L: Sol/Left ● Stokta/In Stock ○ Stokta Yok/Non Stock Item
SMTM Ucuna Uygundur. / Compatible with SMTM Insert.

Sipariş Örneği/Ordering Example : 1 ad./pcs. AIKT-GP-R-20-2-T4



Takım Kodu Ordering Code	Stok Stock	Takım Ölçüleri (mm) Dimension (mm)					Kesici Uç Insert	Yedek Parçaları Spare Parts	
		d	d1	L	l	h		Sıkma Vidası Clamp Screw	Tork Anahtar Torx Key
AIKT-MB07-A16-090-15	●	16	7.4	90	15	14	 MB - 07	 4008-M3x8	 80-T08
AIKT-MB07-A16-090-22	●	16	7.4	90	22	14			
AIKT-MB09-A16-090-19	●	16	9.5	90	19	14	 MB - 09	1515-M4x11	80-T15
AIKT-MB09-A16-095-28	●	16	9.5	95	28	14			
AIKT-MB09-A16-110-40	●	16	9.5	110	40	14			

R: Sağ/Right L: Sol/Left ● Stokta/In Stock ○ Stokta Yok/Non Stock Item
SNDVK Ucuna Uygunudur. / Compatible with SNDVK Insert.

Sipariş Örneği/Ordering Example : 1 ad./pcs. AIKT-MB07-A16-090-15



DELİK DELME ve İŞLEME TAKIMLARI
DRILLING and HOLEMAKING TOOLS





*konusulan
the spoken kalite...
quality...*

U-DRILL

TAKMA UÇLU MATKAPLAR
U-DRILL SYSTEM



www.akkо.com.tr

Дистрибьютер ООО "Ресурс Плюс"
+7 (351) 247-74-40; info@rp-ural.ru



AKKO **A** **TUM** **16** x **D3**

S **P** **G** **T** **06** **02** **04**

2 Kesiş Stili / Cutter Style

TUM : Takma Uçlu Matkap / U-Drill

3 Takım Çapı / Tool Diameter

4 Delme Derinliği / Drilling Depth

D x 2
D x 3
D x 4

5 Uç Şekli / Insert Form

W **S**

6 Serbest Uç Açısı / Clearance angle of Insert

C **P**

8 Uç Tipi / Type of Insert

A J T
 $\beta = 70-90^\circ$ $\beta = 70-90^\circ$ $\beta = 40-60^\circ$

B M U
 $\beta = 70-90^\circ$ $\beta = 40-60^\circ$ $\beta = 40-60^\circ$

C N W
 $\beta = 70-90^\circ$ $\beta = 40-60^\circ$ $\beta = 40-60^\circ$

F Q X Special / Özel

G R

H

$\beta = 70-90^\circ$

10 Kalınlık / Thickness

01 s = 1.59
T1 s = 1.98
02 s = 2.38
T2 s = 2.78
03 s = 3.18
T3 s = 3.97
04 s = 4.76
05 s = 5.56
06 s = 6.35
07 s = 7.94
09 s = 9.52

7 Toleranslar / Tolerance Classes

	d	m	t
A	± 0.025	± 0.005	± 0.025
C	± 0.025	± 0.013	± 0.025
E	± 0.025	± 0.025	± 0.025
F	± 0.013	± 0.005	± 0.025
G	± 0.025	± 0.025	± 0.130
H	± 0.013	± 0.013	± 0.025
J	± 0.05-0.15	± 0.005	± 0.025
K	± 0.05-0.15	± 0.013	± 0.025
L	± 0.05-0.15	± 0.025	± 0.025
M	± 0.05-0.15	± 0.08-0.20	± 0.130
N	± 0.05-0.15	± 0.08-0.20	± 0.025
U	± 0.08-0.25	± 0.13-0.38	± 0.130

d : Daire Ölçüsü / Inscribed Circle
m : Şekle Göre / Refer to Figure
t : Kalınlık / Thickness

9 Kesme Kenar Uzunluğu / Cutting Edge Length

11 Köşe Konfigürasyonu / Corner Radius

01 r = 0.1
02 r = 0.2
04 r = 0.4
08 r = 0.8
12 r = 1.2
16 r = 1.6
24 r = 2.4

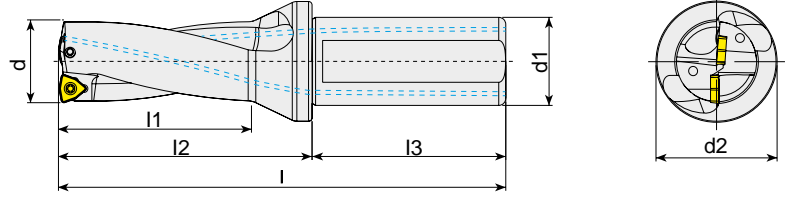

Delme Derinliği = 2xÇap
Drilling Depth = 2xDiameter

Takım Kodu Ordering Code	Stok Stock	Takım Ölçüleri (mm) Dimension (mm)							Kesici Uç Insert	Yedek Parçaları Spare Parts	
		d	d1	d2	l	l1	l2	l3		Sıkma Vidası Screw	Tork Anahtar Torx Key
ATUM 16XD2 WCM. 030208	●	16	25	34	110	32	54	56	WCM. 030208	3008-M2.5x6	80-T08
ATUM 16.5XD2 WCM. 030208	●	16.5	25	34	110	32	54	56			
ATUM 17XD2 WCM. 030208	●	17	25	34	112	34	56	56			
ATUM 17.5XD2 WCM. 030208	●	17.5	25	34	112	34	56	56			
ATUM 18XD2 WCM. 030208	●	18	25	34	114	36	58	56			
ATUM 18.5XD2 WCM. 030208	●	18.5	25	34	114	36	58	56			
ATUM 19XD2 WCM. 030208	●	19	25	34	116	38	60	56			
ATUM 19.5XD2 WCM. 030208	●	19.5	25	34	116	38	60	56			
ATUM 20XD2 WCM. 040208	●	20	25	34	118	40	62	56			
ATUM 20.5XD2 WCM. 040208	●	20.5	25	34	118	40	62	56			
ATUM 21XD2 WCM. 040208	●	21	25	34	120	42	64	56	WCM. 040208	3008-M2.5x6	80-T08
ATUM 21.5XD2 WCM. 040208	●	21.5	25	34	120	42	64	56			
ATUM 22XD2 WCM. 040208	●	22	25	34	122	44	66	56			
ATUM 22.5XD2 WCM. 040208	●	22.5	25	34	122	44	66	56			
ATUM 23XD2 WCM. 040208	●	23	25	34	124	46	68	56			
ATUM 23.5XD2 WCM. 040208	●	23.5	25	34	124	46	68	56			
ATUM 24XD2 WCM. 050308	●	24	25	34	126	48	70	56	WCM. 050308	1008-M3x8	80-T08
ATUM 24.5XD2 WCM. 050308	●	24.5	25	34	126	48	70	56			
ATUM 25XD2 WCM. 050308	●	25	25	34	128	50	72	56			
ATUM 25.5XD2 WCM. 050308	●	25.5	25	34	128	50	72	56			
ATUM 26XD2 WCM. 050308	●	26	25	34	130	52	74	56			
ATUM 26.5XD2 WCM. 050308	●	26.5	25	34	130	52	74	56			
ATUM 27XD2 WCM. 050308	●	27	25	34	132	54	76	56			
ATUM 27.5XD2 WCM. 050308	●	27.5	25	34	132	54	76	56			
ATUM 28XD2 WCM. 050308	●	28	25	34	134	56	78	56			
ATUM 28.5XD2 WCM. 050308	●	28.5	25	34	134	56	78	56			
ATUM 29XD2 WCM. 050308	●	29	25	34	136	58	80	56			
ATUM 29.5XD2 WCM. 050308	●	29.5	25	34	136	58	80	56			

R: Sağ/Right L: Sol/Left ● Stokta/In Stock ○ Stokta Yok/Non Stock Item
ISO Ucuna Uygundur. / Compatible with ISO Insert.

Sipariş Örneği/Ordering Example : 1 ad./pcs. ATUM 16xD2 WCM. 030208
Takma Uçlu Matkap Kullanım Kılavuzu : S 270 / User's Guide For U-Drills : P 270

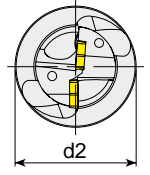
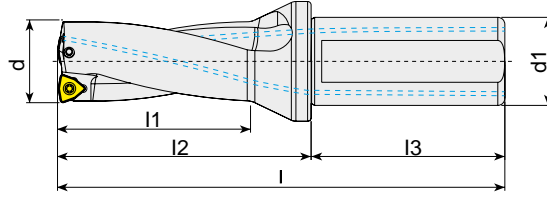

Delme Derinliği = 2xÇap
Drilling Depth = 2xDiameter

Takım Kodu Ordering Code	Stok Stock	Takım Ölçüleri (mm) Dimension (mm)							Kesici Uç Insert	Yedek Parçaları Spare Parts	
		d	d ₁	d ₂	l	l ₁	l ₂	l ₃		Sıkma Vidası Screw	Tork Anahtar Torx Key
ATUM 30XD2 WCM. 06T308	●	30	32	44	147	60	87	60	WCM. 06T308	1510-M3.5x9	80-T10
ATUM 31XD2 WCM. 06T308	●	31	32	44	149	62	89	60			
ATUM 32XD2 WCM. 06T308	●	32	32	44	151	64	91	60			
ATUM 33XD2 WCM. 06T308	●	33	32	44	153	66	93	60			
ATUM 34XD2 WCM. 06T308	●	34	32	44	155	68	95	60			
ATUM 35XD2 WCM. 06T308	●	35	32	44	157	70	97	60			
ATUM 36XD2 WCM. 06T308	●	36	32	44	159	72	99	60			
ATUM 37XD2 WCM. 06T308	●	37	32	44	161	74	101	60			
ATUM 38XD2 WCM. 06T308	●	38	32	44	163	76	103	60			
ATUM 39XD2 WCM. 06T308	●	39	32	44	165	78	105	60			
ATUM 40XD2 WCM. 06T308	●	40	32	44	167	80	107	60			
ATUM 41XD2 WCM. 06T308	●	41	32	44	169	82	109	60			
ATUM 42XD2 WCM. 06T308	●	42	32	44	171	84	111	60			
ATUM 43XD2 WCM. 06T308	●	43	32	44	173	86	113	60			
ATUM 44XD2 WCM. 06T308	●	44	32	44	175	88	115	60			
ATUM 45XD2 WCM. 080412	●	45	40	54	192	90	122	70			
ATUM 46XD2 WCM. 080412	●	46	40	54	194	92	124	70			
ATUM 47XD2 WCM. 080412	●	47	40	54	196	94	126	70			
ATUM 48XD2 WCM. 080412	●	48	40	54	198	96	128	70			
ATUM 49XD2 WCM. 080412	●	49	40	54	200	98	130	70			
ATUM 50XD2 WCM. 080412	●	50	40	54	202	100	132	70			
ATUM 51XD2 WCM. 080412	●	51	40	54	204	102	134	70			
ATUM 52XD2 WCM. 080412	●	52	40	54	206	104	136	70			
ATUM 53XD2 WCM. 080412	●	53	40	54	208	106	138	70			
ATUM 54XD2 WCM. 080412	●	54	40	54	210	108	140	70			
ATUM 55XD2 WCM. 080412	●	55	40	54	212	110	142	70			
ATUM 56XD2 WCM. 080412	●	56	40	64	214	112	144	70			
ATUM 57XD2 WCM. 080412	●	57	40	64	216	114	146	70			
ATUM 58XD2 WCM. 080412	●	58	40	64	218	116	148	70			
ATUM 59XD2 WCM. 080412	●	59	40	64	220	118	150	70			
ATUM 60XD2 WCM. 080412	●	60	40	64	222	120	152	70			

R: Sağ/Right L: Sol/Left ● Stokta/In Stock ○ Stokta Yok/Non Stock Item
ISO Ucuna Uygundur. / Compatible with ISO Insert.

Sipariş Örneği/Ordering Example : 1 ad./pcs. ATUM 30xD2 WCM. 06T308
Takma Uçlu Matkap Kullanım Kılavuzu : S 270 / User's Guide For U-Drills : P 270



Delme Derinliği = 3xÇap
Drilling Depth = 3xDiameter

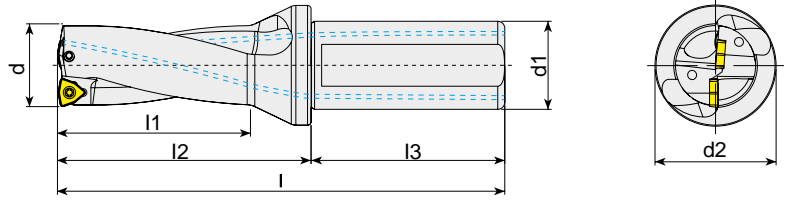



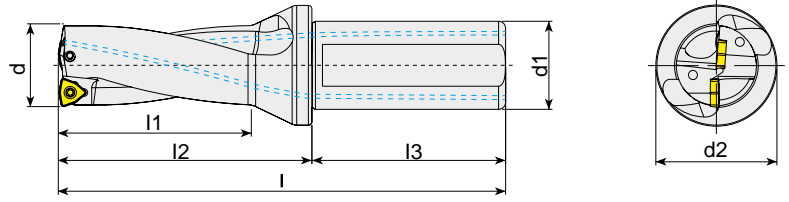

Takım Kodu Ordering Code	Stok Stock	Takım Ölçüleri (mm) Dimension (mm)							Kesici Uç Insert	Yedek Parçaları Spare Parts	
		d	d ₁	d ₂	l	l ₁	l ₂	l ₃		Sıkma Vidası Screw	Tork Anahtar Torx Key
ATUM 16XD3 WCM. 030208	●	16	25	34	126	48	70	56	WCM. 030208	3008-M2.5x6	80-T08
ATUM 16.5XD3 WCM. 030208	●	16.5	25	34	126	48	70	56			
ATUM 17XD3 WCM. 030208	●	17	25	34	129	51	73	56			
ATUM 17.5XD3 WCM. 030208	●	17.5	25	34	129	51	73	56			
ATUM 18XD3 WCM. 030208	●	18	25	34	132	54	76	56			
ATUM 18.5XD3 WCM. 030208	●	18.5	25	34	132	54	76	56			
ATUM 19XD3 WCM. 030208	●	19	25	34	135	57	79	56			
ATUM 19.5XD3 WCM. 030208	●	19.5	25	34	135	57	79	56			
ATUM 20XD3 WCM. 040208	●	20	25	34	138	60	82	56			
ATUM 20.5XD3 WCM. 040208	●	20.5	25	34	138	60	82	56			
ATUM 21XD3 WCM. 040208	●	21	25	34	141	63	85	56			
ATUM 21.5XD3 WCM. 040208	●	21.5	25	34	141	63	85	56			
ATUM 22XD3 WCM. 040208	●	22	25	34	144	66	88	56			
ATUM 22.5XD3 WCM. 040208	●	22.5	25	34	144	66	88	56			
ATUM 23XD3 WCM. 040208	●	23	25	34	147	69	91	56			
ATUM 23.5XD3 WCM. 040208	●	23.5	25	34	147	69	91	56			
ATUM 24XD3 WCM. 050308	●	24	25	34	150	72	94	56	WCM. 050308	1008-M3x8	80-T08
ATUM 24.5XD3 WCM. 050308	●	24.5	25	34	150	72	94	56			
ATUM 25XD3 WCM. 050308	●	25	25	34	153	75	97	56			
ATUM 25.5XD3 WCM. 050308	●	25.5	25	34	153	75	97	56			
ATUM 26XD3 WCM. 050308	●	26	25	34	156	78	100	56			
ATUM 26.5XD3 WCM. 050308	●	26.5	25	34	156	78	100	56			
ATUM 27XD3 WCM. 050308	●	27	25	34	159	81	103	56			
ATUM 27.5XD3 WCM. 050308	●	27.5	25	34	159	81	103	56			
ATUM 28XD3 WCM. 050308	●	28	25	34	162	84	106	56			
ATUM 28.5XD3 WCM. 050308	●	28.5	25	34	162	84	106	56			
ATUM 29XD3 WCM. 050308	●	29	25	34	165	87	109	56	WCM. 06T308	1510-M3.5x9	80-T10
ATUM 29.5XD3 WCM. 050308	●	29.5	25	34	165	87	109	56			
ATUM 30XD3 WCM. 06T308	●	30	32	44	177	90	117	60			
ATUM 30.5XD3 WCM. 06T308	●	30.5	32	44	177	90	117	60			
ATUM 31XD3 WCM. 06T308	●	31	32	44	180	93	120	60			
ATUM 31.5XD3 WCM. 06T308	●	31.5	32	44	180	93	120	60			
ATUM 32XD3 WCM. 06T308	●	32	32	44	183	96	123	60			
ATUM 32.5XD3 WCM. 06T308	●	32.5	32	44	183	96	123	60			
ATUM 33XD3 WCM. 06T308	●	33	32	44	186	99	126	60			
ATUM 33.5XD3 WCM. 06T308	●	33.5	32	44	186	99	126	60			
ATUM 34XD3 WCM. 06T308	●	34	32	44	189	102	129	60			
ATUM 34.5XD3 WCM. 06T308	●	34.5	32	44	189	102	129	60			

R: Sağ/Right L: Sol/Left ● Stokta/In Stock ○ Stokta Yok/Non Stock Item
ISO Ucuna Uygunudur. / Compatiple with ISO Insert.

Sipariş Örneği/Ordering Example : 1 ad./pcs. ATUM 16xD3 WCM. 030208
Takma Uçlu Matkap Kullanım Kılavuzu : S 270 / User's Guide For U-Drills : P 270

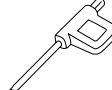

Delme Derinliği = 3xÇap
Drilling Depth = 3xDiameter

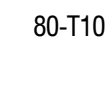
Takım Kodu Ordering Code	Stok Stock	Takım Ölçüleri (mm) Dimension (mm)							Kesici Uç Insert	Yedek Parçaları Spare Parts	
		d	d ₁	d ₂	l	l ₁	l ₂	l ₃		Sıkma Vidası Screw	Tork Anahtar Torx Key
ATUM 35XD3 WCM. 06T308	●	35	32	44	192	105	132	60			
ATUM 35.5XD3 WCM. 06T308	●	35.5	32	44	192	105	132	60			
ATUM 36XD3 WCM. 06T308	●	36	32	44	195	108	135	60			
ATUM 36.5XD3 WCM. 06T308	●	36.5	32	44	195	108	135	60			
ATUM 37XD3 WCM. 06T308	●	37	32	44	198	111	138	60			
ATUM 37.5XD3 WCM. 06T308	●	37.5	32	44	198	111	138	60			
ATUM 38XD3 WCM. 06T308	●	38	32	44	201	114	141	60			
ATUM 38.5XD3 WCM. 06T308	●	38.5	32	44	201	114	141	60			
ATUM 39XD3 WCM. 06T308	●	39	32	44	204	117	144	60			
ATUM 39.5XD3 WCM. 06T308	●	39.5	32	44	204	117	144	60			
ATUM 40XD3 WCM. 06T308	●	40	32	44	207	120	147	60			
ATUM 40.5XD3 WCM. 06T308	●	40.5	32	44	207	120	147	60			
ATUM 41XD3 WCM. 06T308	●	41	32	44	210	123	150	60			
ATUM 41.5XD3 WCM. 06T308	●	41.5	32	44	210	123	150	60			
ATUM 42XD3 WCM. 06T308	●	42	32	44	213	126	153	60			
ATUM 42.5XD3 WCM. 06T308	●	42.5	32	44	213	126	153	60			
ATUM 43XD3 WCM. 06T308	●	43	32	44	216	129	156	60			
ATUM 43.5XD3 WCM. 06T308	●	43.5	32	44	216	129	156	60			
ATUM 44XD3 WCM. 06T308	●	44	32	44	219	132	159	60			
ATUM 44.5XD3 WCM. 06T308	●	44.5	32	44	219	132	159	60			
ATUM 45XD3 WCM. 080412	●	45	40	54	237	135	167	70			
ATUM 45.5XD3 WCM. 080412	●	45.5	40	54	237	135	167	70			
ATUM 46XD3 WCM. 080412	●	46	40	54	240	138	170	70			
ATUM 47XD3 WCM. 080412	●	47	40	54	243	141	173	70			
ATUM 48XD3 WCM. 080412	●	48	40	54	246	144	176	70			
ATUM 49XD3 WCM. 080412	●	49	40	54	249	147	179	70			
ATUM 50XD3 WCM. 080412	●	50	40	54	252	150	182	70			
ATUM 51XD3 WCM. 080412	●	51	40	54	255	153	185	70			
ATUM 52XD3 WCM. 080412	●	52	40	54	258	156	188	70			
ATUM 53XD3 WCM. 080412	●	53	40	54	261	159	191	70			
ATUM 54XD3 WCM. 080412	●	54	40	54	264	162	194	70			
ATUM 55XD3 WCM. 080412	●	55	40	54	267	165	197	70			
ATUM 56XD3 WCM. 080412	●	56	40	64	270	168	200	70			
ATUM 57XD3 WCM. 080412	●	57	40	64	273	171	203	70			
ATUM 58XD3 WCM. 080412	●	58	40	64	276	174	206	70			
ATUM 59XD3 WCM. 080412	●	59	40	64	279	177	209	70			
ATUM 60XD3 WCM. 080412	●	60	40	64	282	180	212	70			

R: Sağ/Right L: Sol/Left ● Stokta/In Stock ○ Stokta Yok/Non Stock Item
ISO Ucuna Uygundur. / Compatible with ISO Insert.

Sipariş Örneği/Ordering Example : 1 ad./pcs. ATUM 35xD3 WCM. 06T308
Takma Uçlu Matkap Kullanım Kılavuzu : S 270 / User's Guide For U-Drills : P 270



Delme Derinliği = 4xÇap
Drilling Depth = 4xDiameter

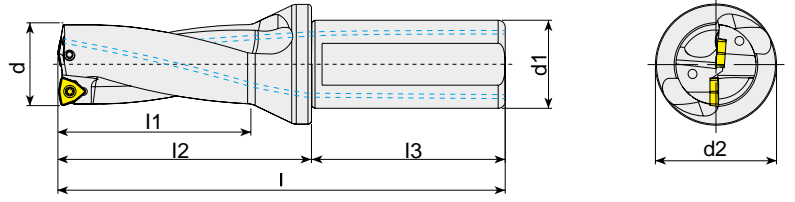

Takım Kodu Ordering Code	Stok Stock	Takım Ölçüleri (mm) Dimension (mm)							Kesici Uç Insert	Yedek Parçaları Spare Parts	
		d	d ₁	d ₂	l	l ₁	l ₂	l ₃		Sıkma Vidası Screw	Tork Anahtar Torx Key
ATUM 16XD4 WCM. 030208	●	16	25	34	142	64	86	56	WCM. 030208		
ATUM 16.5XD4 WCM. 030208	○	16.5	25	34	142	64	86	56			
ATUM 17XD4 WCM. 030208	●	17	25	34	146	68	90	56			
ATUM 17.5XD4 WCM. 030208	○	17.5	25	34	146	68	90	56			
ATUM 18XD4 WCM. 030208	●	18	25	34	150	72	94	56			
ATUM 18.5XD4 WCM. 030208	○	18.5	25	34	150	72	94	56			
ATUM 19XD4 WCM. 030208	●	19	25	34	154	76	98	56			
ATUM 19.5XD4 WCM. 030208	○	19.5	25	34	154	76	98	56			
ATUM 20XD4 WCM. 040208	●	20	25	34	158	80	102	56	WCM. 040208	3008-M2.5x6	80-T08
ATUM 20.5XD4 WCM. 040208	○	20.5	25	34	158	80	102	56			
ATUM 21XD4 WCM. 040208	●	21	25	34	162	84	106	56			
ATUM 21.5XD4 WCM. 040208	○	21.5	25	34	162	84	106	56			
ATUM 22XD4 WCM. 040208	●	22	25	34	166	88	110	56			
ATUM 22.5XD4 WCM. 040208	○	22.5	25	34	166	88	110	56			
ATUM 23XD4 WCM. 040208	●	23	25	34	170	92	114	56			
ATUM 23.5XD4 WCM. 040208	○	23.5	25	34	170	92	114	56			
ATUM 24XD4 WCM. 050308	●	24	25	34	174	96	118	56	WCM. 050308	1008-M3x8	
ATUM 24.5XD4 WCM. 050308	○	24.5	25	34	174	96	118	56			
ATUM 25XD4 WCM. 050308	●	25	25	34	178	100	122	56			
ATUM 25.5XD4 WCM. 050308	○	25.5	25	34	178	100	122	56			
ATUM 26XD4 WCM. 050308	●	26	25	34	182	104	126	56			
ATUM 26.5XD4 WCM. 050308	○	26.5	25	34	182	104	126	56			
ATUM 27XD4 WCM. 050308	●	27	25	34	186	108	130	56			
ATUM 27.5XD4 WCM. 050308	○	27.5	25	34	186	108	130	56			
ATUM 28XD4 WCM. 050308	●	28	25	34	190	112	134	56			
ATUM 28.5XD4 WCM. 050308	○	28.5	25	34	190	112	134	56			
ATUM 29XD4 WCM. 050308	●	29	25	34	194	116	138	56			
ATUM 29.5XD4 WCM. 050308	○	29.5	25	34	194	116	138	56			

R: Sağ/Right L: Sol/Left ● Stokta/In Stock ○ Stokta Yok/Non Stock Item
ISO Ucuna Uygunudur. / Compatible with ISO Insert.

Sipariş Örneği/Ordering Example : 1 ad./pcs. ATUM 16xD4 WCM. 030208
Takma Uçlu Matkap Kullanım Kılavuzu : S 270 / User's Guide For U-Drills : P 270



Delme Derinliği = 4xÇap
Drilling Depth = 4xDiameter

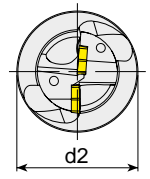
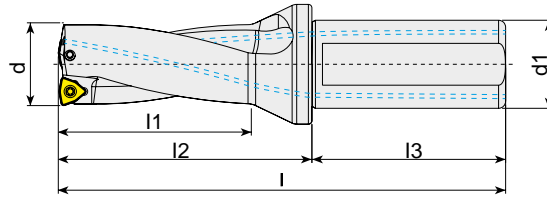

Takım Kodu Ordering Code	Stok Stock	Takım Ölçüleri (mm) Dimension (mm)							Kesici Uç Insert	Yedek Parçaları Spare Parts	
		d	d ₁	d ₂	l	l ₁	l ₂	l ₃		Sıkma Vidası Screw	Tork Anahtar Torx Key
ATUM 30XD4 WCM. 06T308	●	30	32	44	207	120	147	60	WCM. 06T308	1510-M3.5x9	80-T10
ATUM 31XD4 WCM. 06T308	●	31	32	44	211	124	151	60			
ATUM 32XD4 WCM. 06T308	●	32	32	44	215	128	155	60			
ATUM 33XD4 WCM. 06T308	●	33	32	44	219	132	159	60			
ATUM 33.5XD4 WCM. 06T308	●	33.5	32	44	219	132	159	60			
ATUM 34XD4 WCM. 06T308	●	34	32	44	223	136	163	60			
ATUM 35XD4 WCM. 06T308	●	35	32	44	227	140	167	60			
ATUM 36XD4 WCM. 06T308	●	36	32	44	231	144	171	60			
ATUM 37XD4 WCM. 06T308	●	37	32	44	235	148	175	60			
ATUM 38XD4 WCM. 06T308	●	38	32	44	239	152	179	60			
ATUM 38.5XD4 WCM. 06T308	●	38.5	32	44	239	152	179	60			
ATUM 39XD4 WCM. 06T308	●	39	32	44	243	156	183	60			
ATUM 40XD4 WCM. 06T308	●	40	32	44	247	160	187	60			
ATUM 41XD4 WCM. 06T308	●	41	32	44	251	164	191	60			
ATUM 42XD4 WCM. 06T308	●	42	32	44	255	168	195	60			
ATUM 43XD4 WCM. 06T308	●	43	32	44	259	172	199	60			
ATUM 44XD4 WCM. 06T308	●	44	32	44	263	176	203	60			
ATUM 45XD4 WCM. 080412	●	45	40	54	282	180	212	70	WCM. 080412	1515-M4x11	80-T15
ATUM 46XD4 WCM. 080412	●	46	40	54	286	184	216	70			
ATUM 47XD4 WCM. 080412	●	47	40	54	290	188	220	70			
ATUM 48XD4 WCM. 080412	●	48	40	54	294	192	224	70			
ATUM 49XD4 WCM. 080412	●	49	40	54	298	196	228	70			
ATUM 50XD4 WCM. 080412	●	50	40	54	302	200	232	70			

R: Sağ/Right L: Sol/Left ● Stokta/In Stock ○ Stokta Yok/Non Stock Item
ISO Ucuna Uygundur. / Compatible with ISO Insert.

Sipariş Örneği/Ordering Example : 1 ad./pcs. ATUM 30xD4 WCM. 06T308
Takma Uçlu Matkap Kullanım Kılavuzu : S 270 / User's Guide For U-Drills : P 270





Delme Derinliği = 2xÇap
Drilling Depth = 2xDiameter

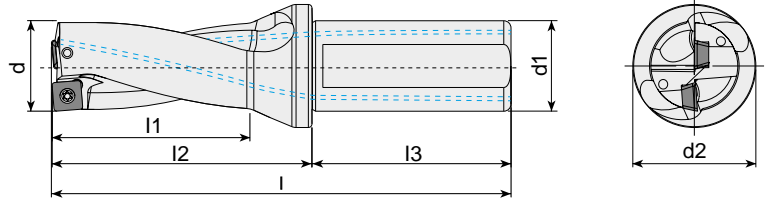

Takım Kodu Ordering Code	Stok Stock	Takım Ölçüleri (mm) Dimension (mm)							Kesici Uç Insert	Yedek Parçaları Spare Parts	
		d	d1	d2	l	l1	l2	l3		Sıkma Vidası Screw	Tork Anahtar Torx Key
ATUM 12.5XD2 SP.. 050204	●	12.5	20	25	96	24	46	50	SP.. 050204	3006-M2x4	80-T06
ATUM 13XD2 SP.. 050204	●	13	20	25	98	26	48	50			
ATUM 13.5XD2 SP.. 050204	●	13.5	20	25	98	26	48	50			
ATUM 14XD2 SP.. 050204	●	14	20	25	100	28	50	50			
ATUM 14.5XD2 SP.. 050204	●	14.5	20	25	100	28	50	50			
ATUM 15XD2 SP.. 050204	●	15	20	25	102	30	52	50	SP.. 060204	3007-M2.2x5	80-T07
ATUM 15.5XD2 SP.. 060204	●	15.5	20	25	102	30	52	50			
ATUM 16XD2 SP.. 060204	●	16	25	34	110	32	54	56			
ATUM 16.5XD2 SP.. 060204	●	16.5	25	34	110	32	54	56			
ATUM 17XD2 SP.. 060204	●	17	25	34	112	34	56	56			
ATUM 17.5XD2 SP.. 060204	●	17.5	25	34	112	34	56	56			
ATUM 18XD2 SP.. 060204	●	18	25	34	114	36	58	56			
ATUM 18.5XD2 SP.. 060204	●	18.5	25	34	114	36	58	56			
ATUM 19XD2 SP.. 060204	●	19	25	34	116	38	60	56			
ATUM 19.5XD2 SP.. 060204	●	19.5	25	34	116	38	60	56			
ATUM 20XD2 SP.. 060204	●	20	25	34	118	40	62	56	SP.. 07T308	3008-M2.5x6	80-T08
ATUM 20.5XD2 SP.. 060204	●	20.5	25	34	118	40	62	56			
ATUM 21XD2 SP.. 060204	●	21	25	34	120	42	64	56			
ATUM 21.5XD2 SP.. 060204	●	21.5	25	34	120	42	64	56			
ATUM 22XD2 SP.. 07T308	●	22	25	34	122	44	66	56			
ATUM 22.5XD2 SP.. 07T308	●	22.5	25	34	122	44	66	56			
ATUM 23XD2 SP.. 07T308	●	23	25	34	124	46	68	56			
ATUM 23.5XD2 SP.. 07T308	●	23.5	25	34	124	46	68	56			
ATUM 24XD2 SP.. 07T308	●	24	25	34	126	48	70	56			
ATUM 24.5XD2 SP.. 07T308	●	24.5	25	34	126	48	70	56			
ATUM 25XD2 SP.. 07T308	●	25	25	34	128	50	72	56			
ATUM 25.5XD2 SP.. 07T308	●	25.5	25	34	128	50	72	56			
ATUM 26XD2 SP.. 07T308	●	26	25	34	130	52	74	56			
ATUM 26.5XD2 SP.. 07T308	●	26.5	25	34	130	52	74	56			
ATUM 27XD2 SP.. 07T308	●	27	25	34	132	54	76	56			
ATUM 27.5XD2 SP.. 07T308	●	27.5	25	34	132	54	76	56			

R: Sağ/Right L: Sol/Left ● Stokta/In Stock ○ Stokta Yok/Non Stock Item
TGTC Ucuna Uygundur. / Compatible with TGTC Insert.

Sipariş Örneği/Ordering Example : 1 ad./pcs. ATUM 12.5xD2 SP.. 050204
Takma Uçlu Matkap Kullanım Kılavuzu : S 270 / User's Guide For U-Drills : P 270



Delme Derinliği = 2xÇap
Drilling Depth = 2xDiameter

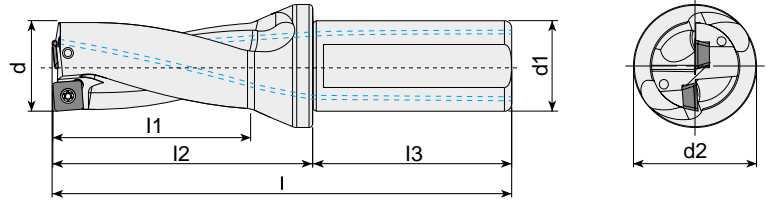

Takım Kodu Ordering Code	Stok Stock	Takım Ölçüleri (mm) Dimension (mm)							Kesici Uç Insert	Yedek Parçaları Spare Parts	
		d	d ₁	d ₂	l	l ₁	l ₂	l ₃		Sıkma Vidası Screw	Tork Anahtar Torx Key
ATUM 28XD2 SP.. 090408	●	28	25	34	134	56	78	56	SP.. 090408	4015-M3.5x9	80-T15
ATUM 28.5XD2 SP.. 090408	●	28.5	25	34	134	56	78	56			
ATUM 29XD2 SP.. 090408	●	29	25	34	136	58	80	56			
ATUM 29.5XD2 SP.. 090408	●	29.5	25	34	136	58	80	56			
ATUM 30XD2 SP.. 090408	●	30	32	44	147	60	87	60			
ATUM 31XD2 SP.. 090408	●	31	32	44	149	62	89	60			
ATUM 32XD2 SP.. 090408	●	32	32	44	151	64	91	60			
ATUM 33XD2 SP.. 090408	●	33	32	44	153	66	93	60			
ATUM 34XD2 SP.. 110408	●	34	32	44	155	68	95	60			
ATUM 35XD2 SP.. 110408	●	35	32	44	157	70	97	60			
ATUM 36XD2 SP.. 110408	●	36	32	44	159	72	99	60			
ATUM 37XD2 SP.. 110408	●	37	32	44	161	74	101	60			
ATUM 38XD2 SP.. 110408	●	38	32	44	163	76	103	60			
ATUM 39XD2 SP.. 110408	●	39	32	44	165	78	105	60			
ATUM 40XD2 SP.. 110408	●	40	32	44	167	80	107	60			
ATUM 41XD2 SP.. 110408	●	41	32	44	169	82	109	60	SP.. 140512	1020-M5x11	80-T20
ATUM 42XD2 SP.. 140512	●	42	32	44	171	84	111	60			
ATUM 43XD2 SP.. 140512	●	43	32	44	173	86	113	60			
ATUM 44XD2 SP.. 140512	●	44	32	44	175	88	115	60			
ATUM 45XD2 SP.. 140512	●	45	40	54	192	90	122	70			
ATUM 46XD2 SP.. 140512	●	46	40	54	194	92	124	70			
ATUM 47XD2 SP.. 140512	●	47	40	54	196	94	126	70			
ATUM 48XD2 SP.. 140512	●	48	40	54	198	96	128	70			
ATUM 49XD2 SP.. 140512	●	49	40	54	200	98	130	70			
ATUM 50XD2 SP.. 140512	●	50	40	54	202	100	132	70			

R: Sağ/Right L: Sol/Left ● Stokta/In Stock ○ Stokta Yok/Non Stock Item
TGTC Ucuna Uygundur. / Compatible with TGTC Insert.

Sipariş Örneği/Ordering Example : 1 ad./pcs. ATUM 28xD2 SP.. 090408
Takma Uçlu Matkap Kullanım Kılavuzu : S 270 / User's Guide For U-Drills : P 270



Delme Derinliği = 3xÇap
Drilling Depth = 3xDiameter

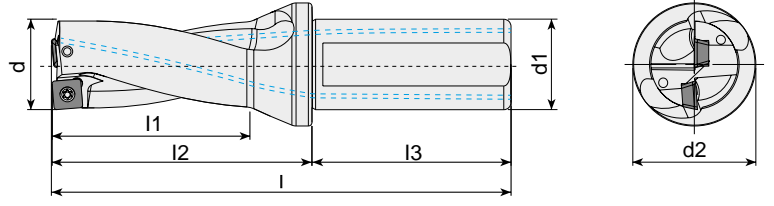

Takım Kodu Ordering Code	Stok Stock	Takım Ölçüleri (mm) Dimension (mm)							Kesici Uç Insert	Yedek Parçaları Spare Parts	
		d	d1	d2	l	l1	l2	l3		Sıkma Vidası Screw	Tork Anahtar Torx Key
ATUM 12.5XD3 SP.. 050204	●	12.5	20	25	108	36	58	50	SP.. 050204	3006-M2x4	80-T06
ATUM 13XD3 SP.. 050204	●	13	20	25	111	39	61	50			
ATUM 13.5XD3 SP.. 050204	●	13.5	20	25	111	39	61	50			
ATUM 14XD3 SP.. 050204	●	14	20	25	114	42	64	50			
ATUM 14.5XD3 SP.. 050204	●	14.5	20	25	114	42	64	50			
ATUM 15XD3 SP.. 050204	●	15	20	25	117	45	67	50			
ATUM 15.5XD3 SP.. 060204	●	15.5	20	25	117	45	67	50	SP.. 060204	3007-M2.2x5	80-T07
ATUM 16XD3 SP.. 060204	●	16	25	34	126	48	70	56			
ATUM 16.5XD3 SP.. 060204	●	16.5	25	34	126	48	70	56			
ATUM 17XD3 SP.. 060204	●	17	25	34	129	51	73	56			
ATUM 17.5XD3 SP.. 060204	●	17.5	25	34	129	51	73	56			
ATUM 18XD3 SP.. 060204	●	18	25	34	132	54	76	56			
ATUM 18.5XD3 SP.. 060204	●	18.5	25	34	132	54	76	56			
ATUM 19XD3 SP.. 060204	●	19	25	34	135	57	79	56			
ATUM 19.5XD3 SP.. 060204	●	19.5	25	34	135	57	79	56			
ATUM 20XD3 SP.. 060204	●	20	25	34	138	60	82	56			
ATUM 20.5XD3 SP.. 060204	●	20.5	25	34	138	60	82	56			
ATUM 21XD3 SP.. 060204	●	21	25	34	141	63	85	56			
ATUM 21.5XD3 SP.. 060204	●	21.5	25	34	141	63	85	56			
ATUM 22XD3 SP.. 07T308	●	22	25	34	144	66	88	56			
ATUM 22.5XD3 SP.. 07T308	●	22.5	25	34	144	66	88	56			
ATUM 23XD3 SP.. 07T308	●	23	25	34	147	69	91	56			
ATUM 23.5XD3 SP.. 07T308	●	23.5	25	34	147	69	91	56			
ATUM 24XD3 SP.. 07T308	●	24	25	34	150	72	94	56			
ATUM 24.5XD3 SP.. 07T308	●	24.5	25	34	150	72	94	56			
ATUM 25XD3 SP.. 07T308	●	25	25	34	153	75	97	56			
ATUM 25.5XD3 SP.. 07T308	●	25.5	25	34	153	75	97	56			
ATUM 26XD3 SP.. 07T308	●	26	25	34	156	78	100	56	SP.. 090408	4015-M3.5x9	80-T15
ATUM 26.5XD3 SP.. 07T308	●	26.5	25	34	156	78	100	56			
ATUM 27XD3 SP.. 07T308	●	27	25	34	159	81	103	56			
ATUM 27.5XD3 SP.. 07T308	●	27.5	25	34	159	81	103	56			
ATUM 28XD3 SP.. 090408	●	28	25	34	162	84	106	56			
ATUM 28.5XD3 SP.. 090408	●	28.5	25	34	162	84	106	56			
ATUM 29XD3 SP.. 090408	●	29	25	34	165	87	109	56			
ATUM 29.5XD3 SP.. 090408	●	29.5	25	34	165	87	109	56			
ATUM 30XD3 SP.. 090408	●	30	32	44	177	90	117	60			
ATUM 30.5XD3 SP.. 090408	●	30.5	32	44	177	90	117	60			
ATUM 31XD3 SP.. 090408	●	31	32	44	180	93	120	60			
ATUM 31.5XD3 SP.. 090408	●	31.5	32	44	180	93	120	60			
ATUM 32XD3 SP.. 090408	●	32	32	44	183	96	123	60			
ATUM 32.5XD3 SP.. 090408	●	32.5	32	44	183	96	123	60			
ATUM 33XD3 SP.. 090408	●	33	32	44	186	99	126	60			
ATUM 33.5XD3 SP.. 090408	●	33.5	32	44	186	99	126	60			

R: Sağ/Right L: Sol/Left ● Stokta/In Stock ○ Stokta Yok/Non Stock Item
TGTC Ucuna Uygundur. / Compatible with TGTC Insert.

Sipariş Örneği/Ordering Example : 1 ad./pcs. ATUM 12.5XD3 SP.. 050204
Takma Uçlu Matkap Kullanım Kılavuzu : S 270 / User's Guide For U-Drills : P 270



Delme Derinliği = 3xÇap
Drilling Depth = 3xDiameter

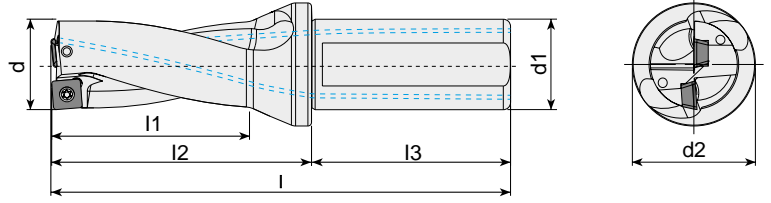

Takım Kodu Ordering Code	Stok Stock	Takım Ölçüleri (mm) Dimension (mm)							Kesici Uç Insert	Yedek Parçaları Spare Parts	
		d	d ₁	d ₂	l	l ₁	l ₂	l ₃		Sıkma Vidası Screw	Tork Anahtar Torx Key
ATUM 34XD3 SP.. 110408	●	34	32	44	189	102	129	60	SP.. 110408	1515-M4x11	80-T15
ATUM 34.5XD3 SP.. 110408	●	34.5	32	44	189	102	129	60			
ATUM 35XD3 SP.. 110408	●	35	32	44	192	105	132	60			
ATUM 35.5XD3 SP.. 110408	●	35.5	32	44	192	105	132	60			
ATUM 36XD3 SP.. 110408	●	36	32	44	195	108	135	60			
ATUM 36.5XD3 SP.. 110408	●	36.5	32	44	195	108	135	60			
ATUM 37XD3 SP.. 110408	●	37	32	44	198	111	138	60			
ATUM 37.5XD3 SP.. 110408	●	37.5	32	44	198	111	138	60			
ATUM 38XD3 SP.. 110408	●	38	32	44	201	114	141	60			
ATUM 38.5XD3 SP.. 110408	●	38.5	32	44	201	114	141	60			
ATUM 39XD3 SP.. 110408	●	39	32	44	204	117	144	60			
ATUM 39.5XD3 SP.. 110408	●	39.5	32	44	204	117	144	60			
ATUM 40XD3 SP.. 110408	●	40	32	44	207	120	147	60			
ATUM 40.5XD3 SP.. 110408	●	40.5	32	44	207	120	147	60			
ATUM 41XD3 SP.. 110408	●	41	32	44	210	123	150	60			
ATUM 41.5XD3 SP.. 110408	●	41.5	32	44	210	123	150	60			
ATUM 42XD3 SP.. 140512	●	42	32	44	213	126	153	60	SP.. 140512	1020-M5x11	80-T20
ATUM 42.5XD3 SP.. 140512	●	42.5	32	44	213	126	153	60			
ATUM 43XD3 SP.. 140512	●	43	32	44	216	129	156	60			
ATUM 43.5XD3 SP.. 140512	●	43.5	32	44	216	129	156	60			
ATUM 44XD3 SP.. 140512	●	44	32	44	219	132	159	60			
ATUM 44.5XD3 SP.. 140512	●	44.5	32	44	219	132	159	60			
ATUM 45XD3 SP.. 140512	●	45	40	54	237	135	167	70			
ATUM 45.5XD3 SP.. 140512	●	45.5	40	54	237	135	167	70			
ATUM 46XD3 SP.. 140512	●	46	40	54	240	138	170	70			
ATUM 47XD3 SP.. 140512	●	47	40	54	243	141	173	70			
ATUM 48XD3 SP.. 140512	●	48	40	54	246	144	176	70			
ATUM 49XD3 SP.. 140512	●	49	40	54	249	147	179	70			
ATUM 50XD3 SP.. 140512	●	50	40	54	252	150	182	70			
ATUM 51XD3 SP.. 140512	●	51	40	54	255	153	185	70			
ATUM 52XD3 SP.. 140512	●	52	40	54	258	156	188	70			

R: Sağ/Right L: Sol/Left ● Stokta/In Stock ○ Stokta Yok/Non Stock Item
TGTC Ucuna Uygundur. / Compatiple with TGTC Insert.

Sipariş Örneği/Ordering Example : 1 ad./pcs. ATUM 34xD3 SP.. 110408
Takma Uçlu Matkap Kullanım Kılavuzu : S 270 / User's Guide For U-Drills : P 270



Delme Derinliği = 4xÇap
Drilling Depth = 4xDiameter

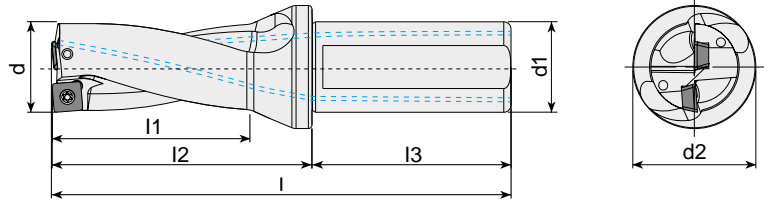

Takım Kodu Ordering Code	Stok Stock	Takım Ölçüleri (mm) Dimension (mm)							Kesici Uç Insert	Yedek Parçaları Spare Parts	
		d	d1	d2	l	l1	l2	l3		Sıkma Vidası Screw	Tork Anahtar Torx Key
ATUM 13XD4 SP.. 050204	●	13	20	25	124	52	74	50	SP.. 050204	3006-M2x4	80-T06
ATUM 14XD4 SP.. 050204	●	14	20	25	128	56	78	50			
ATUM 15XD4 SP.. 050204	●	15	20	25	132	60	82	50			
ATUM 16XD4 SP.. 060204	●	16	25	34	142	64	86	56	SP.. 060204	3007-M2.2x5	80-T07
ATUM 17XD4 SP.. 060204	●	17	25	34	146	68	90	56			
ATUM 17.5XD4 SP.. 060204	●	17	25	34	146	68	90	56			
ATUM 18XD4 SP.. 060204	●	18	25	34	150	72	94	56			
ATUM 19XD4 SP.. 060204	●	19	25	34	154	76	98	56			
ATUM 19.5XD4 SP.. 060204	●	19.5	25	34	154	76	98	56			
ATUM 20XD4 SP.. 060204	●	20	25	34	158	80	102	56			
ATUM 21XD4 SP.. 060204	●	21	25	34	162	84	106	56	SP.. 07T308	3008-M2.5x6	80-T08
ATUM 22XD4 SP.. 07T308	●	22	25	34	166	88	110	56			
ATUM 23XD4 SP.. 07T308	●	23	25	34	170	92	114	56			
ATUM 23.5XD4 SP.. 07T308	●	23.5	25	34	170	92	114	56			
ATUM 24XD4 SP.. 07T308	●	24	25	34	174	96	118	56			
ATUM 25XD4 SP.. 07T308	●	25	25	34	178	100	122	56			
ATUM 26XD4 SP.. 07T308	●	26	25	34	182	104	126	56			
ATUM 27XD4 SP.. 07T308	●	27	25	34	186	108	130	56	SP.. 090408	4015-M3.5x9	80-T15
ATUM 27.5XD4 SP.. 07T308	●	27.5	25	34	186	108	130	56			
ATUM 28XD4 SP.. 090408	●	28	25	34	190	112	134	56			
ATUM 29XD4 SP.. 090408	●	29	25	34	194	116	138	56			
ATUM 30XD4 SP.. 090408	●	30	32	44	207	120	147	60			
ATUM 31XD4 SP.. 090408	●	31	32	44	211	124	151	60			
ATUM 32XD4 SP.. 090408	●	32	32	44	215	128	155	60			
ATUM 33XD4 SP.. 090408	●	33	32	44	219	132	159	60	SP.. 110408	1515-M4x11	80-T15
ATUM 33.5XD4 SP.. 090408	●	33.5	32	44	219	132	159	60			
ATUM 34XD4 SP.. 110408	●	34	32	44	223	136	163	60			
ATUM 35XD4 SP.. 110408	●	35	32	44	227	140	167	60			
ATUM 36XD4 SP.. 110408	●	36	32	44	231	144	171	60			
ATUM 37XD4 SP.. 110408	●	37	32	44	235	148	175	60			
ATUM 38XD4 SP.. 110408	●	38	32	44	239	152	179	60			
ATUM 39XD4 SP.. 110408	●	39	32	44	243	156	183	60	SP.. 140512	1020-M5x11	80-T20
ATUM 40XD4 SP.. 110408	●	40	32	44	247	160	187	60			
ATUM 41XD4 SP.. 110408	●	41	32	44	251	164	191	60			
ATUM 42XD4 SP.. 140512	●	42	32	44	255	168	195	60			
ATUM 43XD4 SP.. 140512	●	43	32	44	259	172	199	60	SP.. 140512	1020-M5x11	80-T20
ATUM 44XD4 SP.. 140512	●	44	32	44	263	176	203	60			

R: Sağ/Right L: Sol/Left ● Stokta/In Stock ○ Stokta Yok/Non Stock Item
TGTC Ucuna Uygundur. / Compatible with TGTC Insert.

Sipariş Örneği/Ordering Example : 1 ad./pcs. ATUM 13xD4 SP.. 050204
Takma Uçlu Matkap Kullanım Kılavuzu : S 270 / User's Guide For U-Drills : P 270



Delme Derinliği = 2xÇap
Drilling Depth = 2xDiameter

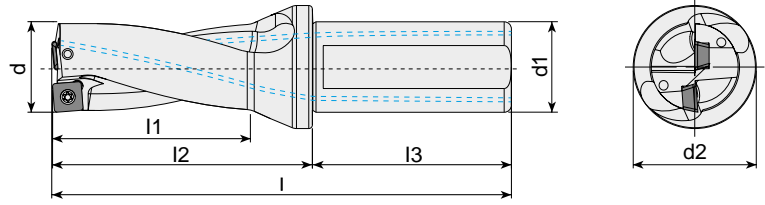

Takım Kodu Ordering Code	Stok Stock	Takım Ölçüleri (mm) Dimension (mm)							Kesici Uç Insert	Yedek Parçaları Spare Parts	
		d	d1	d2	l	l1	l2	l3		Sıkma Vidası Screw	Tork Anahtar Torx Key
ATUM 12.5XD2 SPGT 050204	●	12.5	20	25	96	24	46	50	SPGT 050204	3006-M2x4	80-T06
ATUM 13XD2 SPGT 050204	●	13	20	25	98	26	48	50			
ATUM 14XD2 SPGT 050204	●	14	20	25	100	28	50	50			
ATUM 15XD2 SPGT 050204	●	15	20	25	102	30	52	50			
ATUM 16XD2 SPGT 060204	●	16	25	34	110	32	54	56	SPGT 060204	3007-M2.2x5	80-T07
ATUM 16.5XD2 SPGT 060204	●	16.5	25	34	110	32	54	56			
ATUM 17XD2 SPGT 060204	●	17	25	34	112	34	56	56			
ATUM 17.5XD2 SPGT 060204	●	17.5	25	34	112	34	56	56			
ATUM 18XD2 SPGT 060204	●	18	25	34	114	36	58	56			
ATUM 19XD2 SPGT 060204	●	19	25	34	116	38	60	56			
ATUM 20XD2 SPGT 060204	●	20	25	34	118	40	62	56			
ATUM 22XD2 SPGT 07T308	●	22	25	34	122	44	66	56	SPGT 07T308	3008-M2.5x6	80-T08
ATUM 22.5XD2 SPGT 07T308	●	22.5	25	34	122	44	66	56			
ATUM 23XD2 SPGT 07T308	●	23	25	34	124	46	68	56			
ATUM 24XD2 SPGT 07T308	●	24	25	34	126	48	70	56			
ATUM 25XD2 SPGT 07T308	●	25	25	34	128	50	72	56			
ATUM 26XD2 SPGT 07T308	●	26	25	34	130	52	74	56			
ATUM 28XD2 SPGT 090408	●	28	25	34	134	56	78	56	SPGT 090408	4015-M3.5x9	80-T15
ATUM 29XD2 SPGT 090408	●	29	25	34	136	58	80	56			
ATUM 30XD2 SPGT 090408	●	30	32	44	147	60	87	60			
ATUM 32XD2 SPGT 090408	●	32	32	44	151	64	91	60	SPGT 110408	1515-M4x11	80-T15
ATUM 35XD2 SPGT 110408	●	35	32	44	157	70	97	60			
ATUM 36XD2 SPGT 110408	●	36	32	44	159	72	99	60			
ATUM 40XD2 SPGT 110408	●	40	32	44	167	80	107	60			

R: Sağ/Right L: Sol/Left ● Stokta/In Stock ○ Stokta Yok/Non Stock Item
ZCC Uçuna Uygundur. / Compatible with ZCC Insert.

Sipariş Örneği/Ordering Example : 1 ad./pcs. ATUM 13XD2 SPGT 050204
Takma Uçlu Matkap Kullanım Kılavuzu : S 270 / User's Guide For U-Drills : P 270





Delme Derinliği = 3xÇap
Drilling Depth = 3xDiameter

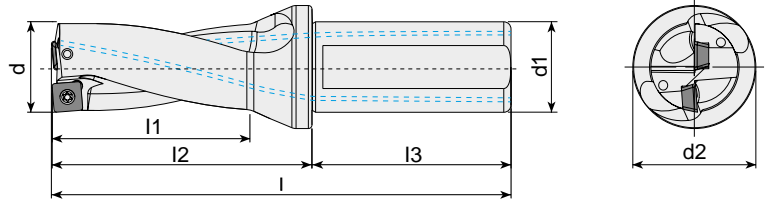

Takım Kodu Ordering Code	Stok Stock	Takım Ölçüleri (mm) Dimension (mm)							Kesici Uç Insert	Yedek Parçaları Spare Parts	
		d	d1	d2	l	l1	l2	l3		Sıkma Vidası Screw	Tork Anahtar Torx Key
ATUM 12.5XD3 SPGT 050204	●	12.5	20	25	108	36	58	50	SPGT 050204	3006-M2x4	80-T06
ATUM 13XD3 SPGT 050204	●	13	20	25	111	39	61	50			
ATUM 13.5XD3 SPGT 050204	●	13.5	20	25	111	39	61	50			
ATUM 14XD3 SPGT 050204	●	14	20	25	114	42	64	50			
ATUM 14.5XD3 SPGT 050204	●	14.5	20	25	114	42	64	50			
ATUM 15XD3 SPGT 050204	●	15	20	25	117	45	67	50			
ATUM 15.5XD3 SPGT 060204	●	15.5	20	25	117	45	67	50	SPGT 060204	3007-M2.2x5	80-T07
ATUM 16XD3 SPGT 060204	●	16	25	34	126	48	70	56			
ATUM 16.5XD3 SPGT 060204	●	16.5	25	34	126	48	70	56			
ATUM 17XD3 SPGT 060204	●	17	25	34	129	51	73	56			
ATUM 17.5XD3 SPGT 060204	●	17.5	25	34	129	51	73	56			
ATUM 18XD3 SPGT 060204	●	18	25	34	132	54	76	56			
ATUM 18.5XD3 SPGT 060204	●	18.5	25	34	132	54	76	56			
ATUM 19XD3 SPGT 060204	●	19	25	34	135	57	79	56			
ATUM 19.5XD3 SPGT 060204	●	19.5	25	34	135	57	79	56			
ATUM 20XD3 SPGT 060204	●	20	25	34	138	60	82	56			
ATUM 20.5XD3 SPGT 060204	●	20.5	25	34	138	60	82	56			
ATUM 21XD3 SPGT 060204	●	21	25	34	141	63	85	56			
ATUM 21.5XD3 SPGT 060204	●	21.5	25	34	141	63	85	56			
ATUM 22XD3 SPGT 07T308	●	22	25	34	144	66	88	56			
ATUM 22.5XD3 SPGT 07T308	●	22.5	25	34	144	66	88	56			
ATUM 23XD3 SPGT 07T308	●	23	25	34	147	69	91	56			
ATUM 23.5XD3 SPGT 07T308	●	23.5	25	34	147	69	91	56			
ATUM 24XD3 SPGT 07T308	●	24	25	34	150	72	94	56			
ATUM 24.5XD3 SPGT 07T308	●	24.5	25	34	150	72	94	56			
ATUM 25XD3 SPGT 07T308	●	25	25	34	153	75	97	56			
ATUM 25.5XD3 SPGT 07T308	●	25.5	25	34	153	75	97	56			
ATUM 26XD3 SPGT 07T308	●	26	25	34	156	78	100	56			
ATUM 26.5XD3 SPGT 07T308	●	26.5	25	34	156	78	100	56			
ATUM 27XD3 SPGT 07T308	●	27	25	34	159	81	103	56	SPGT 090408	4015-M3.5x9	80-T15
ATUM 27.5XD3 SPGT 07T308	●	27.5	25	34	159	81	103	56			
ATUM 28XD3 SPGT 090408	●	28	25	34	162	84	106	56			
ATUM 28.5XD3 SPGT 090408	●	28.5	25	34	162	84	106	56			
ATUM 29XD3 SPGT 090408	●	29	25	34	165	87	109	56			
ATUM 29.5XD3 SPGT 090408	●	29.5	25	34	165	87	109	56			
ATUM 30XD3 SPGT 090408	●	30	32	44	177	90	117	60			
ATUM 31XD3 SPGT 090408	●	31	32	44	180	93	120	60			
ATUM 32XD3 SPGT 090408	●	32	32	44	183	96	123	60			
ATUM 33XD3 SPGT 090408	●	33	32	44	186	99	126	60			

R: Sağ/Right L: Sol/Left ● Stokta/In Stock ○ Stokta Yok/Non Stock Item
ZCC Ucuna Uygundur. / Compatible with ZCC Insert.

Sipariş Örneği/Ordering Example : 1 ad./pcs. ATUM 12.5XD3 SPGT 050204
Takma Uçlu Matkap Kullanım Kılavuzu : S 270 / User's Guide For U-Drills : P 270



Delme Derinliği = 3xÇap
= 4xÇap
Drilling Depth = 3xDiameter
= 4xDiameter

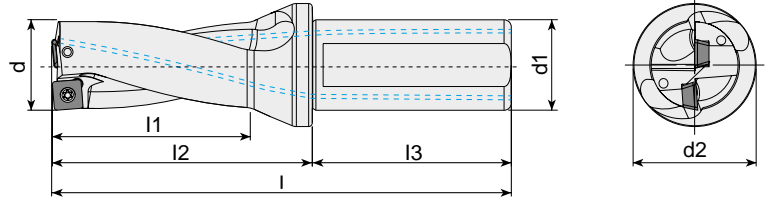

Takım Kodu Ordering Code	Stok Stock	Takım Ölçüleri (mm) Dimension (mm)							Kesici Uç Insert	Yedek Parçaları Spare Parts	
		d	d1	d2	l	l1	l2	l3		Sıkma Vidası Screw	Tork Anahtar Torx Key
ATUM 34XD3 SPGT 110408	●	34	32	44	189	102	129	60	SPGT 110408	1515-M4x11	80-T15
ATUM 35XD3 SPGT 110408	●	35	32	44	192	105	132	60			
ATUM 37XD3 SPGT 110408	●	37	32	44	198	111	138	60			
ATUM 38XD3 SPGT 110408	●	38	32	44	201	114	141	60			
ATUM 39XD3 SPGT 110408	●	39	32	44	204	117	144	60			
ATUM 40XD3 SPGT 110408	●	40	32	44	207	120	147	60	SPGT 140512	1020-M5x11	80-T20
ATUM 42XD3 SPGT 140512	●	42	32	44	213	126	153	60			
ATUM 43XD3 SPGT 140512	●	43	32	44	216	129	156	60			
ATUM 44XD3 SPGT 140512	●	44	32	44	219	132	159	60			
ATUM 49XD3 SPGT 140512	●	49	40	54	249	147	179	70			
ATUM 50XD3 SPGT 140512	●	50	40	54	252	150	182	70			

R: Sağ/Right L: Sol/Left ● Stokta/In Stock ○ Stokta Yok/Non Stock Item
ZCC Ucuna Uygundur. / Compatible with ZCC Insert.

Sipariş Örneği/Ordering Example : 1 ad./pcs. ATUM 34XD3 SPGT 110408
Takma Uçlu Matkap Kullanım Kılavuzu : S 270 / User's Guide For U-Drills : P 270





Delme Derinliği = 4xÇap
Drilling Depth = 4xDiameter

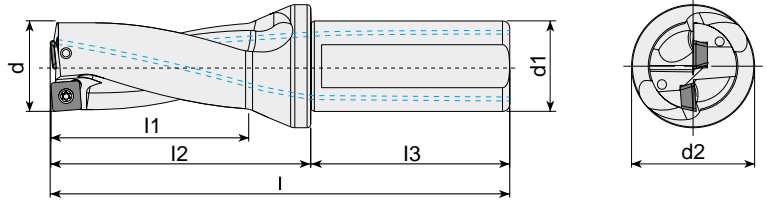

Takım Kodu Ordering Code	Stok Stock	Takım Ölçüleri (mm) Dimension (mm)							Kesici Uç Insert	Yedek Parçaları Spare Parts	
		d	d1	d2	l	l1	l2	l3		Sıkma Vidası Screw	Tork Anahtar Torx Key
ATUM 13XD4 SPGT 050204	●	13	20	25	124	52	74	50	SPGT 050204	3006-M2x4	80-T06
ATUM 14XD4 SPGT 050204	●	14	20	25	128	56	78	50			
ATUM 15XD4 SPGT 050204	●	15	20	25	132	60	82	50			
ATUM 16XD4 SPGT 060204	●	16	25	34	142	64	86	56			
ATUM 17XD4 SPGT 060204	●	17	25	34	146	68	90	56	SPGT 060204	3007-M2.2x5	80-T07
ATUM 17.5XD4 SPGT 060204	●	17.5	25	34	146	68	90	56			
ATUM 18XD4 SPGT 060204	●	18	25	34	150	72	94	56			
ATUM 19XD4 SPGT 060204	●	19	25	34	154	76	98	56			
ATUM 19.5XD4 SPGT 060204	●	19.5	25	34	154	76	98	56			
ATUM 20XD4 SPGT 060204	●	20	25	34	158	80	102	56			
ATUM 21XD4 SPGT 060204	●	21	25	34	162	84	106	56			
ATUM 22XD4 SPGT 07T308	●	22	25	34	166	88	110	56	SPGT 07T308	3008-M2.5x6	80-T08
ATUM 23XD4 SPGT 07T308	●	23	25	34	170	92	114	56			
ATUM 23.5XD4 SPGT 07T308	●	23.5	25	34	170	92	114	56			
ATUM 24XD4 SPGT 07T308	●	24	25	34	174	96	118	56			
ATUM 25XD4 SPGT 07T308	●	25	25	34	178	100	122	56			
ATUM 26XD4 SPGT 07T308	●	26	25	34	182	104	126	56			
ATUM 27.5XD4 SPGT 07T308	●	27.5	25	34	186	108	130	56	SPGT 090408	4015-M3.5x9	80-T15
ATUM 28XD4 SPGT 090408	●	28	25	34	190	112	134	56			
ATUM 29XD4 SPGT 090408	●	29	25	34	194	116	138	56			
ATUM 30XD4 SPGT 090408	●	30	32	44	207	120	147	60			
ATUM 33.5XD4 SPGT 090408	●	33.5	32	44	219	132	159	60	SPGT 110408	1515-M4x11	80-T15
ATUM 38XD4 SPGT 110408	●	38	32	44	239	152	179	60			

R: Sağ/Right L: Sol/Left ● Stokta/In Stock ○ Stokta Yok/Non Stock Item
ZCC Ucuna Uygunudur. / Compatible with ZCC Insert.

Sipariş Örneği/Ordering Example : 1 ad./pcs. ATUM 13XD4 SPGT 050204
Takma Uçlu Matkap Kullanım Kılavuzu : S 270 / User's Guide For U-Drills : P 270





Delme Derinliği = 3xÇap
Drilling Depth = 3xDiameter

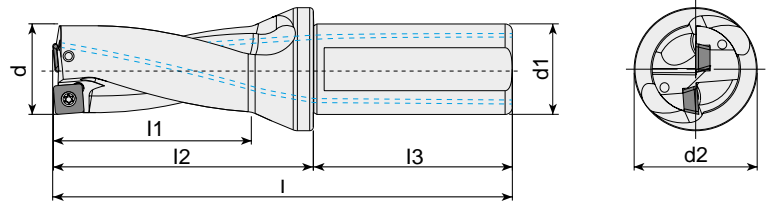

Takım Kodu Ordering Code	Stok Stock	Takım Ölçüleri (mm) Dimension (mm)							Kesici Uç Insert	Yedek Parçaları Spare Parts	
		d	d ₁	d ₂	l	l ₁	l ₂	l ₃		Sıkma Vidası Screw	Tork Anahtar Torx Key
ATUM 14XD3 SO.. 050204	●	14	20	25	114	42	64	50	SO.. 050204		
ATUM 15XD3 SO.. 050204	●	15	20	25	117	45	67	50			
ATUM 16XD3 SO.. 050204	●	16	25	34	126	48	70	56			
ATUM 16.5XD3 SO.. 050204	●	16.5	25	34	126	48	70	56			
ATUM 17XD3 SO.. 050204	●	17	25	34	129	51	73	56			
ATUM 17.5XD3 SO.. 050204	●	17.5	25	34	129	51	73	56	SO.. 060304	3007-M2.2x5	80-T07
ATUM 18XD3 SO.. 060304	●	18	25	34	132	54	76	56			
ATUM 20XD3 SO.. 060304	●	20	25	34	138	60	82	56	SO.. 070305	3008-M2.5x6	80-T08
ATUM 22XD3 SO.. 070305	●	22	25	34	144	66	88	56			
ATUM 22.5XD3 SO.. 070305	●	22.5	25	34	144	66	88	56			
ATUM 23XD3 SO.. 070305	●	23	25	34	147	69	91	56	SO.. 09T306	4010-M3x8	80-T10
ATUM 24XD3 SO.. 070305	●	24	25	34	150	72	94	56			
ATUM 25XD3 SO.. 09T306	●	25	25	34	153	75	97	56	SO.. 09T306	4010-M3x8	80-T10
ATUM 26XD3 SO.. 09T306	●	26	25	34	156	78	100	56			
ATUM 30XD3 SO.. 09T306	●	30	32	44	177	90	117	60			

ISCR Ucuna Uygun. / Compatiple with ISCR Insert.



Delme Derinliği = 4xÇap
Drilling Depth = 4xDiameter

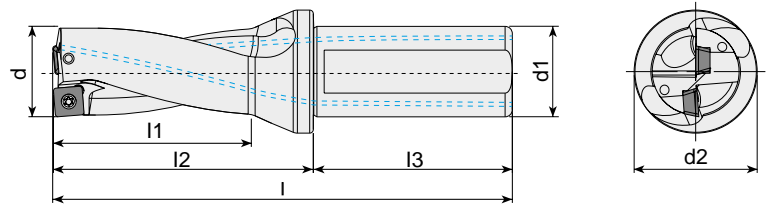

Takım Kodu Ordering Code	Stok Stock	Takım Ölçüleri (mm) Dimension (mm)							Kesici Uç Insert	Yedek Parçaları Spare Parts	
		d	d ₁	d ₂	l	l ₁	l ₂	l ₃		Sıkma Vidası Screw	Tork Anahtar Torx Key
ATUM 14XD4 SO.. 050204	●	14	20	25	128	56	78	50	SO.. 050204		
ATUM 14.5XD4 SO.. 050204	●	14.5	20	25	128	56	78	50			
ATUM 15.5XD4 SO.. 050204	●	15.5	20	25	132	60	82	50			
ATUM 17XD4 SO.. 050204	●	17	25	34	146	68	90	56			
ATUM 19XD4 SO.. 060304	●	19	25	34	154	76	98	56			
ATUM 19.5XD4 SO.. 060304	●	19.5	25	34	154	76	98	56	SO.. 060304	3007-M2.2x5	80-T07
ATUM 20XD4 SO.. 060304	●	20	25	34	158	80	102	56			
ATUM 22XD4 SO.. 070305	●	22	25	34	166	88	110	56	SO.. 070305	3008-M2.5x6	80-T08
ATUM 22.5XD4 SO.. 070305	●	22.5	25	34	166	88	110	56			

R: Sağ/Right L: Sol/Left ● Stokta/In Stock ○ Stokta Yok/Non Stock Item
ISCR Ucuna Uygun. / Compatiple with ISCR Insert.

Sipariş Örneği/Ordering Example : 1 ad./pcs. ATUM 14XD3 SO.. 050204
Takma Uçlu Matkap Kullanım Kılavuzu : S 270 / User's Guide For U-Drills : P 270



Delme Derinliği = 2xÇap
Drilling Depth = 2xDiameter

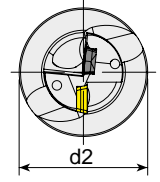
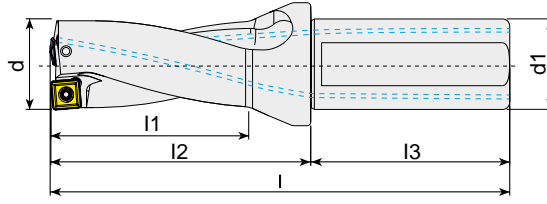

Takım Kodu Ordering Code	Stok Stock	Takım Ölçüleri (mm) Dimension (mm)									Kesici Uç Insert	Yedek Parçaları Spare Parts	
		d	d ₁	d ₂	l	l ₁	l ₂	l ₃	Sıkma Vidası Screw	Tork Anahtar Torx Key			
ATUM 14XD2 KDR 0502..	●	14	20	25	100	28	50	50	SPMT 050204-XOMT 050204			80-T06	
ATUM 18XD2 KDR 0602..	●	18	25	34	114	36	58	56	SPMT 060205-XOMT 060204			80-T07	
ATUM 20XD2 KDR 07T2..	●	20	25	34	118	40	62	56	SPMT 07T208 XOMT 07T205			80-T08	
ATUM 22XD2 KDR 07T2..	●	22	25	34	122	44	66	56					
ATUM 24XD2 KDR 0903..	●	24	25	34	126	48	70	56	SPMT 090308 XOMT 090305			80-T08	
ATUM 25XD2 KDR 0903..	●	25	25	34	128	50	72	56					
ATUM 26XD2 KDR 0903..	●	26	25	34	130	52	74	56	SPMT 11T308 XOMT 11T306			80-T15	
ATUM 28XD2 KDR 0903..	●	28	25	34	134	56	78	56					
ATUM 30XD2 KDR 11T3..	●	30	25	34	147	60	87	60					
ATUM 32XD2 KDR 11T3..	●	32	32	44	151	64	91	60					
ATUM 34XD2 KDR 11T3..	●	34	32	44	155	68	95	60					

KRLY Ucuna Uygun. / Compatible with KRLY Insert.



Delme Derinliği = 4xÇap
Drilling Depth = 4xDiameter

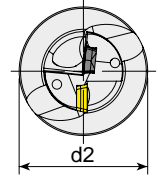
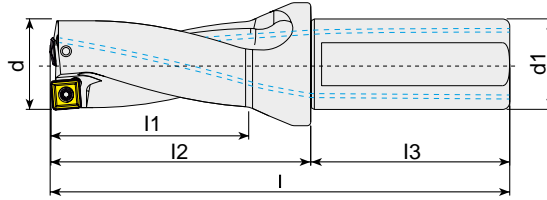

Takım Kodu Ordering Code	Stok Stock	Takım Ölçüleri (mm) Dimension (mm)									Kesici Uç Insert	Yedek Parçaları Spare Parts	
		d	d ₁	d ₂	l	l ₁	l ₂	l ₃	Sıkma Vidası Screw	Tork Anahtar Torx Key			
ATUM 14XD4 KDR 0502..	●	14	20	25	128	56	78	50	SPMT 050204 XOMT 050204			80-T06	
ATUM 14.5XD4 KDR 0502..	●	14.5	20	25	128	56	78	50					
ATUM 15XD4 KDR 0502..	●	15	20	25	132	60	82	50	SPMT 060205 XOMT 060204			80-T07	
ATUM 15.5XD4 KDR 0502..	●	15.5	20	25	132	60	82	50					
ATUM 16XD4 KDR 0502..	●	16	25	34	142	64	86	56	SPMT 07T208 XOMT 07T205			80-T08	
ATUM 17XD4 KDR 0602..	●	17	25	34	146	68	90	56					
ATUM 17.5XD4 KDR 0602..	●	17.5	25	34	146	68	90	56	SPMT 090308 XOMT 090305			80-T08	
ATUM 18XD4 KDR 0602..	●	18	25	34	150	72	94	56					
ATUM 18.5XD4 KDR 0602..	●	18.5	25	34	150	72	94	56	SPMT 11T308 XOMT 11T306			80-T15	
ATUM 19XD4 KDR 0602..	●	19	25	34	154	76	98	56					
ATUM 20XD4 KDR 07T2..	●	20	25	34	158	80	102	56	SPMT 090308 XOMT 090305			80-T15	
ATUM 21XD4 KDR 07T2..	●	21	25	34	162	84	106	56					
ATUM 22XD4 KDR 07T2..	●	22	25	34	166	88	110	56					
ATUM 24XD4 KDR 0903..	●	24	25	34	174	96	118	56					
ATUM 25XD4 KDR 0903..	●	25	25	34	178	100	122	56					

R: Sağ/Right L: Sol/Left ● Stokta/In Stock ○ Stokta Yok/Non Stock Item
KRLY Ucuna Uygun. / Compatible with KRLY Insert.

Sipariş Örneği/Ordering Example : 1 ad./pcs. ATUM 14XD2 KDR 0502..
Takma Uçlu Matkap Kullanım Kılavuzu : S 270 / User's Guide For U-Drills : P 270



Delme Derinliği = 3xÇap
Drilling Depth = 3xDiameter

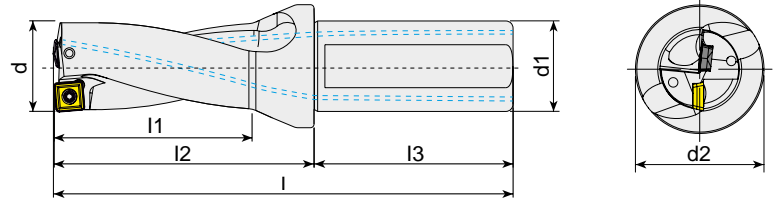

Takım Kodu Ordering Code	Stok Stock	Takım Ölçüleri (mm) Dimension (mm)							Kesici Uç Insert	Yedek Parçaları Spare Parts	
		d	d1	d2	l	l1	l2	l3		Sıkma Vidası Screw	Tork Anahtar Torx Key
ATUM 12.5XD3 KDR 0402..	●	12.5	20	25	108	36	58	50	SPMT 040204 XOMT 040204	3006-M2x4	80-T06
ATUM 13XD3 KDR 0402..	●	13	20	25	111	39	61	50			
ATUM 14XD3 KDR 0502..	●	14	20	25	114	42	64	50	SPMT 050204 XOMT 050204	3006-M2x4	80-T06
ATUM 14.5XD3 KDR 0502..	●	14.5	20	25	114	42	64	50			
ATUM 15XD3 KDR 0502..	●	15	20	25	117	45	67	50	SPMT 060205 XOMT 060204	3007-M2.2x5	80-T07
ATUM 15.5XD3 KDR 0502..	●	15.5	20	25	117	45	67	50			
ATUM 16XD3 KDR 0502..	●	16	25	34	126	48	70	56	SPMT 07T208 XOMT 07T205	3008-M2.5x6	80-T08
ATUM 16.5XD3 KDR 0602..	●	16.5	25	34	126	48	70	56			
ATUM 17XD3 KDR 0602..	●	17	25	34	129	51	73	56	SPMT 090308 XOMT 090305	3008-M3x7	80-T15
ATUM 17.5XD3 KDR 0602..	●	17.5	25	34	129	51	73	56			
ATUM 18XD3 KDR 0602..	●	18	25	34	132	54	76	56	SPMT 11T308 XOMT 11T306	4015-M3.5x9	80-T15
ATUM 18.5XD3 KDR 0602..	●	18.5	25	34	132	54	76	56			
ATUM 19XD3 KDR 0602..	●	19	25	34	135	57	79	56	SPMT 130410 XOMT 130406	1515-M4x11	80-T15
ATUM 19.5XD3 KDR 0602..	●	19.5	25	34	135	57	79	56			
ATUM 20XD3 KDR 07T2..	●	20	25	34	138	60	82	56	SPMT 130410 XOMT 130406	1515-M4x11	80-T15
ATUM 20.5XD3 KDR 07T2..	●	20.5	25	34	138	60	82	56			
ATUM 21XD3 KDR 07T2..	●	21	25	34	141	63	85	56	SPMT 130410 XOMT 130406	1515-M4x11	80-T15
ATUM 21.5XD3 KDR 07T2..	●	21.5	25	34	141	63	85	56			
ATUM 22XD3 KDR 07T2..	●	22	25	34	144	66	88	56	SPMT 130410 XOMT 130406	1515-M4x11	80-T15
ATUM 22.5XD3 KDR 07T2..	●	22.5	25	34	144	66	88	56			
ATUM 23XD3 KDR 07T2..	●	23	25	34	147	69	91	56	SPMT 130410 XOMT 130406	1515-M4x11	80-T15
ATUM 23.5XD3 KDR 07T2..	●	23.5	25	34	147	69	91	56			
ATUM 24XD3 KDR 0903..	●	24	25	34	150	72	94	56	SPMT 130410 XOMT 130406	1515-M4x11	80-T15
ATUM 24.5XD3 KDR 0903..	●	24.5	25	34	150	72	94	56			
ATUM 25XD3 KDR 0903..	●	25	25	34	153	75	97	56	SPMT 130410 XOMT 130406	1515-M4x11	80-T15
ATUM 25.5XD3 KDR 0903..	●	25.5	25	34	153	75	97	56			
ATUM 26XD3 KDR 0903..	●	26	25	34	156	78	100	56	SPMT 130410 XOMT 130406	1515-M4x11	80-T15
ATUM 26.5XD3 KDR 0903..	●	26.5	25	34	156	78	100	56			
ATUM 27XD3 KDR 0903..	●	27	25	34	159	81	103	56	SPMT 130410 XOMT 130406	1515-M4x11	80-T15
ATUM 27.5XD3 KDR 0903..	●	27.5	25	34	159	81	103	56			
ATUM 28XD3 KDR 0903..	●	28	25	34	162	84	106	56	SPMT 130410 XOMT 130406	1515-M4x11	80-T15
ATUM 28.5XD3 KDR 0903..	●	28.5	25	34	162	84	106	56			
ATUM 29XD3 KDR 0903..	●	29	25	34	165	87	109	56	SPMT 130410 XOMT 130406	1515-M4x11	80-T15
ATUM 29.5XD3 KDR 0903..	●	29.5	25	34	165	87	109	56			
ATUM 30XD3 KDR 11T3..	●	30	32	44	177	90	117	60	SPMT 130410 XOMT 130406	1515-M4x11	80-T15
ATUM 30.5XD3 KDR 11T3..	●	30.5	32	44	177	90	117	60			
ATUM 32XD3 KDR 11T3..	●	32	32	44	183	96	123	60	SPMT 130410 XOMT 130406	1515-M4x11	80-T15
ATUM 32.5XD3 KDR 11T3..	●	32.5	32	44	183	96	123	60			
ATUM 33XD3 KDR 11T3..	●	33	32	44	186	99	126	60	SPMT 130410 XOMT 130406	1515-M4x11	80-T15
ATUM 33.5XD3 KDR 11T3..	●	33.5	32	44	186	99	126	60			
ATUM 34XD3 KDR 11T3..	●	34	32	44	189	102	129	60	SPMT 130410 XOMT 130406	1515-M4x11	80-T15
ATUM 34.5XD3 KDR 11T3..	●	34.5	32	44	189	102	129	60			
ATUM 35XD3 KDR 11T3..	●	35	32	44	192	105	132	60	SPMT 130410 XOMT 130406	1515-M4x11	80-T15
ATUM 35.5XD3 KDR 11T3..	●	35.5	32	44	192	105	132	60			
ATUM 38XD3 KDR 1304..	●	38	32	44	201	114	141	60	SPMT 130410 XOMT 130406	1515-M4x11	80-T15
ATUM 38.5XD3 KDR 1304..	●	38.5	32	44	201	114	141	60			
ATUM 39XD3 KDR 1304..	●	39	32	44	204	117	144	60	SPMT 130410 XOMT 130406	1515-M4x11	80-T15
ATUM 39.5XD3 KDR 1304..	●	39.5	32	44	204	117	144	60			
ATUM 40XD3 KDR 1304..	●	40	32	44	207	120	147	60	SPMT 130410 XOMT 130406	1515-M4x11	80-T15
ATUM 40.5XD3 KDR 1304..	●	40.5	32	44	207	120	147	60			

R: Sağ/Right L: Sol/Left ● Stokta/In Stock ○ Stokta Yok/Non Stock Item
KRLY Ucuna Uygundür. / Compatiple with KRLY Insert.

Sipariş Örneği/Ordering Example : 1 ad./pcs. ATUM 12.5XD3 KDR 0402..
Takma Uçlu Matkap Kullanım Kılavuzu : S 270 / User's Guide For U-Drills : P 270



Delme Derinliği = 2xÇap
Drilling Depth = 2xDiameter

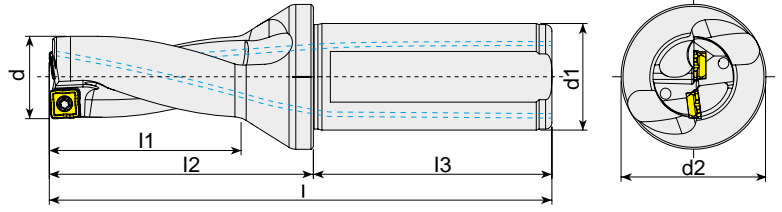

Takım Kodu Ordering Code	Stok Stock	Takım Ölçüleri (mm) Dimension (mm)							Kesici Uç Insert	Yedek Parçaları Spare Parts	
		d	d ₁	d ₂	l	l ₁	l ₂	l ₃		Sıkma Vidası Screw	Tork Anahtar Torx Key
ATUM 14XD2 SOMT 050204	●	14	20	25	100	28	50	50			
ATUM 16XD2 SOMT 050204	●	16	25	34	110	32	54	56	SOMT 050204	3006-M2x4	80-T06
ATUM 17XD2 SOMT 060204	●	17	25	34	112	34	56	56			
ATUM 18XD2 SOMT 060204	●	18	25	34	114	36	58	56	SOMT 060204	3007-M2.2x5	80-T07
ATUM 20XD2 SOMT 070306	●	20	25	34	118	40	62	56			
ATUM 22XD2 SOMT 070306	●	22	25	34	122	44	66	56	SOMT 070306		
ATUM 24XD2 SOMT 08T306	●	24	25	34	126	48	70	56			
ATUM 25XD2 SOMT 08T306	●	25	25	34	128	50	72	56	SOMT 08T306	3008-M2.5x6	80-T08
ATUM 26XD2 SOMT 08T306	●	26	25	34	130	52	74	56			
ATUM 27XD2 SOMT 09T308	●	27	25	34	132	54	76	56	SOMT 09T308		
ATUM 28XD2 SOMT 09T308	●	28	25	34	134	56	78	56			
ATUM 30XD2 SOMT 09T308	●	30	32	44	147	60	87	60	SOMT 11T308	4015-M3.5x9	80-T15
ATUM 32XD2 SOMT 11T308	●	32	32	44	151	64	91	60			
ATUM 33XD2 SOMT 11T308	●	33	32	44	153	66	93	60	SOMT 11T308		
ATUM 34XD2 SOMT 11T308	●	34	32	44	155	68	95	60			
ATUM 35XD2 SOMT 11T308	●	35	32	44	157	70	97	60	SOMT 130408	4015-M4x11	
ATUM 37XD2 SOMT 130408	●	37	32	44	161	74	101	60			
ATUM 38XD2 SOMT 130408	●	38	32	44	163	76	103	60	SOMT 130408	4015-M4x11	
ATUM 40XD2 SOMT 130408	●	40	32	44	167	80	107	60			
ATUM 45XD2 SOMT 150510	●	45	40	54	192	90	122	70	SOMT 150510	1020-M5x11	80-T20

R: Sağ/Right L: Sol/Left ● Stokta/In Stock ○ Stokta Yok/Non Stock Item
TGTC Ucuna Uygunudur. / Compatiple with TGTC Insert.

Sipariş Örneği/Ordering Example : 1 ad./pcs. ATUM 14XD2 SOMT 050204
Takma Uçlu Matkap Kullanım Kılavuzu : S 270 / User's Guide For U-Drills : P 270



www.akkо.com.tr

Дистрибутор ООО "Ресурс Плюс"
+7 (351) 247-74-40; info@rp-ural.ru

new



Delme Derinliği = 3xÇap
Drilling Depth = 3xDiameter

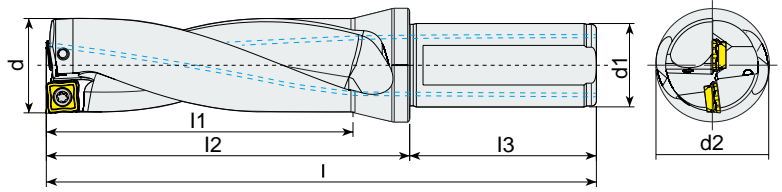

Takım Kodu Ordering Code	Stok Stock	Takım Ölçüleri (mm) Dimension (mm)							Kesici Uç Insert	Yedek Parçaları Spare Parts	
		d	d ₁	d ₂	l	l ₁	l ₂	l ₃		Sıkma Vidası Screw	Tork Anahtar Torx Key
ATUM 13XD3 SOMT 050204	●	13	20	25	111	39	61	50	SOMT 050204	3006-M2x4	80-T06
ATUM 14XD3 SOMT 050204	●	14	20	25	114	42	64	50			
ATUM 14.5XD3 SOMT 050204	●	14.5	20	25	114	42	64	50			
ATUM 15XD3 SOMT 050204	●	15	20	25	117	45	67	50			
ATUM 15.5XD3 SOMT 050204	●	15.5	20	25	117	45	67	50			
ATUM 16XD3 SOMT 050204	●	16	25	34	126	48	70	56	SOMT 060204	3007-M2.2x5	80-T07
ATUM 16.5XD3 SOMT 060204	●	16.5	25	34	126	48	70	56			
ATUM 17XD3 SOMT 060204	●	17	25	34	129	51	73	56			
ATUM 17.5XD3 SOMT 060204	●	17.5	25	34	129	51	73	56			
ATUM 18XD3 SOMT 060204	●	18	25	34	132	54	76	56			
ATUM 18.5XD3 SOMT 060204	●	18.5	25	34	132	54	76	56			
ATUM 19XD3 SOMT 060204	●	19	25	34	135	57	79	56			
ATUM 19.5XD3 SOMT 070306	●	19.5	25	34	135	57	79	56			
ATUM 20XD3 SOMT 070306	●	20	25	34	138	60	82	56			
ATUM 20.5XD3 SOMT 070306	●	20.5	25	34	138	60	82	56			
ATUM 21XD3 SOMT 070306	●	21	25	34	141	63	85	56	SOMT 08T306	3008-M2.5x6	80-T08
ATUM 22XD3 SOMT 070305	●	22	25	34	144	66	88	56			
ATUM 22.5XD3 SOMT 08T306	●	22.5	25	34	144	66	88	56			
ATUM 23XD3 SOMT 08T306	●	23	25	34	147	69	91	56			
ATUM 23.5XD3 SOMT 08T306	●	23.5	25	34	147	69	91	56			
ATUM 24XD3 SOMT 08T306	●	24	25	34	150	72	94	56			
ATUM 24.5XD3 SOMT 08T306	●	24.5	25	34	150	72	94	56			
ATUM 25XD3 SOMT 08T306	●	25	25	34	153	75	97	56			
ATUM 26XD3 SOMT 08T306	●	26	25	34	156	78	100	56			
ATUM 27XD3 SOMT 09T308	●	27	25	34	159	81	103	56			
ATUM 27.5XD3 SOMT 09T308	●	27.5	25	34	159	81	103	56			
ATUM 28XD3 SOMT 09T308	●	28	25	34	162	84	106	56			
ATUM 29XD3 SOMT 09T308	●	29	25	34	165	87	109	56			
ATUM 30XD3 SOMT 09T308	●	30	32	44	177	90	117	60			
ATUM 32XD3 SOMT 11T308	●	32	32	44	183	96	123	60			
ATUM 33XD3 SOMT 11T308	●	33	32	44	186	99	126	60			
ATUM 34XD3 SOMT 11T308	●	34	32	44	189	102	129	60			
ATUM 35XD3 SOMT 11T308	●	35	32	44	192	105	132	60			
ATUM 36XD3 SOMT 11T308	●	36	32	44	195	108	135	60			
ATUM 37XD3 SOMT 130408	●	37	32	44	198	111	138	60	SOMT 130408	4015-M4x11	80-T20
ATUM 38XD3 SOMT 130408	●	38	32	44	201	114	141	60			
ATUM 39XD3 SOMT 130408	●	39	32	44	204	117	144	60			
ATUM 40XD3 SOMT 130408	●	40	32	44	207	120	147	60	SOMT 150510	1020-M5x11	80-T20
ATUM 45XD3 SOMT 150510	●	45	40	54	237	135	167	70			
ATUM 49XD3 SOMT 150510	●	49	40	54	249	147	179	70			
ATUM 50XD3 SOMT 150510	●	50	40	54	252	150	182	70			

R: Sağ/Right L: Sol/Left ● Stokta/In Stock ○ Stokta Yok/Non Stock Item
TGTC Ucuna Uygundur. / Compatiple with TGTC Insert.

Sipariş Örneği/Ordering Example : 1 ad./pcs. ATUM 13XD3 SOMT 050204
Takma Uçlu Matkap Kullanım Kılavuzu : S 270 / User's Guide For U-Drills : P 270



Delme Derinliği = 4xÇap
Drilling Depth = 4xDiameter

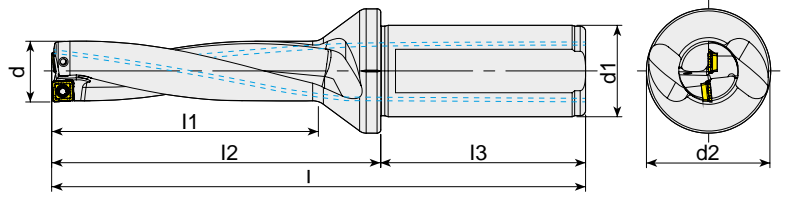

Takım Kodu Ordering Code	Stok Stock	Takım Ölçüleri (mm) Dimension (mm)							Kesici Uç Insert	Yedek Parçaları Spare Parts	
		d	d ₁	d ₂	l	l ₁	l ₂	l ₃		Sıkma Vidası Screw	Tork Anahtar Torx Key
ATUM 14XD4 SOMT 050204	●	14	20	25	128	56	78	50			
ATUM 16XD4 SOMT 050204	●	16	25	34	142	64	86	56	SOMT 050204	3006-M2x4	80-T06
ATUM 17XD4 SOMT 060204	●	17	25	34	146	68	90	56			
ATUM 18XD4 SOMT 060204	●	18	25	34	150	72	94	56	SOMT 060204	3007-M2.2x5	80-T07
ATUM 19XD4 SOMT 060204	●	19	25	34	154	76	98	56			
ATUM 20XD4 SOMT 070306	●	20	25	34	158	80	102	56	SOMT 070306	3007-M2.2x5	80-T07
ATUM 21XD4 SOMT 070306	●	21	25	34	162	84	106	56			
ATUM 22XD4 SOMT 070306	●	22	25	34	166	88	110	56	SOMT 070306	3007-M2.2x5	80-T07
ATUM 24XD4 SOMT 08T306	●	24	25	34	174	96	118	56			
ATUM 25XD4 SOMT 08T306	●	25	25	34	178	100	122	56	SOMT 08T306	3008-M2.5x6	80-T08

R: Sağ/Right L: Sol/Left ● Stokta/In Stock ○ Stokta Yok/Non Stock Item
TGTC Ucuna Uygunudur. / Compatible with TGTC Insert.

Sipariş Örneği/Ordering Example : 1 ad./pcs. ATUM 14XD4 SOMT 050204
Takma Uçlu Matkap Kullanım Kılavuzu : S 270 / User's Guide For U-Drills : P 270





Delme Derinliği = 5xÇap
Drilling Depth = 5xDiameter

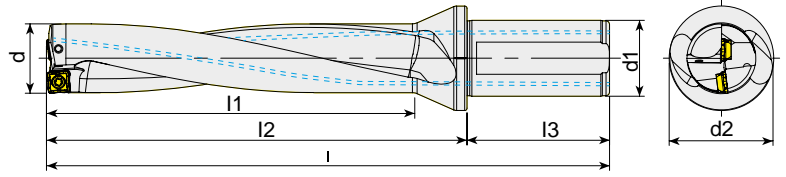

Takım Kodu Ordering Code	Stok Stock	Takım Ölçüleri (mm) Dimension (mm)							Kesici Uç Insert	Yedek Parçaları Spare Parts	
		d	d ₁	d ₂	l	l ₁	l ₂	l ₃		Sıkma Vidası Screw	Tork Anahtar Torx Key
ATUM 13XD5 SOMT 050204	●	13	20	25	137	65	87	50			
ATUM 14XD5 SOMT 050204	●	14	20	25	142	70	92	50			
ATUM 15XD5 SOMT 050204	●	15	20	25	147	75	97	50			
ATUM 16XD5 SOMT 050204	●	16	25	34	158	80	102	56			
ATUM 17.5XD5 SOMT 060204	●	17	25	34	163	85	107	56			
ATUM 18XD5 SOMT 060204	●	18	25	34	168	90	112	56			
ATUM 19XD5 SOMT 060204	●	19	25	34	173	95	117	56			
ATUM 19.5XD5 SOMT 070306	●	19	25	34	173	95	117	56			
ATUM 20XD5 SOMT 070306	●	20	25	34	178	100	122	56			
ATUM 21XD5 SOMT 070306	●	21	25	34	183	105	127	56			
ATUM 22XD5 SOMT 070306	●	22	25	34	188	110	132	56			
ATUM 23XD5 SOMT 08T306	●	23	25	34	193	115	137	56			
ATUM 24XD5 SOMT 08T306	●	24	25	34	198	120	142	56			
ATUM 25XD5 SOMT 08T306	●	25	25	34	203	125	147	56			
ATUM 26XD5 SOMT 08T306	●	26	25	34	208	130	152	56			
ATUM 27XD5 SOMT 09T308	●	27	25	34	213	135	157	56			
ATUM 28XD5 SOMT 09T308	●	28	25	34	218	140	162	56			
ATUM 29XD5 SOMT 09T308	●	29	25	34	223	145	167	56			
ATUM 30XD5 SOMT 09T308	●	30	32	44	237	150	177	60			
ATUM 33XD5 SOMT 11T308	●	33	32	44	252	165	192	60			
ATUM 34XD5 SOMT 11T308	●	34	32	44	257	170	197	60			
ATUM 35XD5 SOMT 11T308	●	35	32	44	262	175	202	60			
ATUM 36XD5 SOMT 11T308	●	36	32	44	267	180	207	60			

R: Sağ/Right L: Sol/Left ● Stokta/In Stock ○ Stokta Yok/Non Stock Item
TGTC Ucuna Uygunudur. / Compatible with TGTC Insert.

Sipariş Örneği/Ordering Example : 1 ad./pcs. ATUM 13XD5 SOMT 050204
Takma Uçlu Matkap Kullanım Kılavuzu : S 270 / User's Guide For U-Drills : P 270

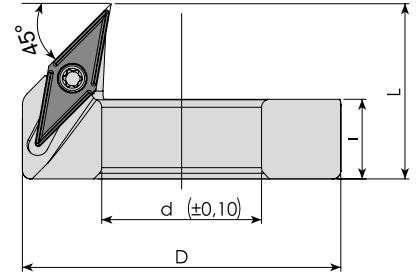

Takım Kodu Ordering Code	Stok Stock	Takım Ölçüleri (mm) Dimension (mm)				Kullanılacak ATUM Ölçüsü Compatible ATUM Diameter	Yedek Parçaları Spare Parts					
		D	d	l	L		ATUM Ø	Kesici Uç Insert	Sıkma Vidası Screw	Tork Anahtarı Torx Key	Montaj Vidası Mounting Screw	Montaj Vida Anahtarı Mounting Screw Key
ADCR-120-VB1103	●	32	12	10	22	12.5	VBM. 1103..					
ADCR-125-VB1103	●	32.5	12.5	10	22	13						
ADCR-130-VB1103	●	33	13	10	22	13.5						
ADCR-135-VB1103	●	33.5	13.5	10	22	14						
ADCR-140-VB1103	●	34	14	10	22	14.5						
ADCR-145-VB1103	●	34.5	14.5	10	22	15						
ADCR-150-VB1103	●	35	15	10	22	15.5-16						
ADCR-155-VB1103	●	35.5	15.5	10	22	16.5						
ADCR-160-VB1103	●	36	16	10	22	17						
ADCR-165-VB1103	●	36.5	16.5	10	22	17.5						
ADCR-170-VB1103	●	37	17	10	22	18						
ADCR-175-VB1103	●	37.5	17.5	10	22	18.5						
ADCR-180-VB1103	●	38	18	10	22	19						
ADCR-185-VB1103	●	38.5	18.5	10	22	19.5						
ADCR-190-VB1103	●	39	19	10	22	20						
ADCR-195-VB1103	●	39.5	19.5	10	22	20.5						
ADCR-200-VB1103	●	40	20	10	22	21						
ADCR-205-VB1103	●	40.5	20.5	10	22	21.5						
ADCR-210-VB1103	●	41	21	10	22	22						
ADCR-215-VB1103	●	41.5	21.5	10	22	22.5						
ADCR-220-VB1103	●	42	22	10	22	23						
ADCR-225-VB1103	●	42.5	22.5	10	22	23.5						
ADCR-230-VB1103	●	43	23	10	22	24						
ADCR-235-VB1103	●	43.5	23.5	10	22	24.5						
ADCR-240-VB1103	●	44	24	10	22	25						
ADCR-245-VB1103	●	44.5	24.5	10	22	25.5						
ADCR-250-VB1103	●	45	25	10	22	26						
ADCR-255-VB1103	●	45.5	25.5	10	22	26.5						
ADCR-260-VB1103	●	46	26	10	22	27						
ADCR-265-VB1103	●	46.5	26.5	10	22	27.5						
ADCR-270-VB1103	●	47	27	10	22	28						
ADCR-275-VB1103	●	47.5	27.5	10	22	28.5						
ADCR-280-VB1103	●	48	28	10	22	29						
ADCR-285-VB1103	●	48.5	28.5	10	22	29.5						
ADCR-290-VB1103	●	49	29	10	22	30						
ADCR-295-VB1103	●	49.5	29.5	10	22	30.5						
ADCR-300-VB1103	●	50	30	10	22	31						

R: Sağ/Right L: Sol/Left ● Stokta/In Stock ○ Stokta Yok/Non Stock Item

Sipariş Örneği/Ordering Example : 1 ad./pcs. ADCR-120-VB1103



Tavsiye Edilen / Recommended

A

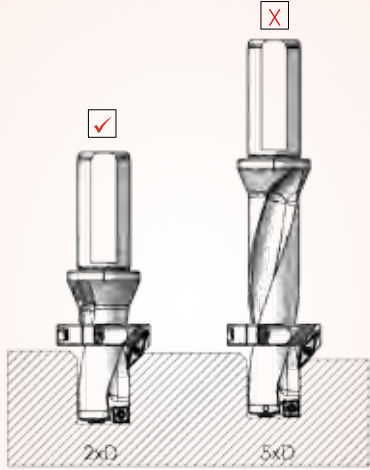

Mümkünse, her zaman kısa bir delme takımı kullanın. Değilse, titreşimi en aza indirmek için kesme hızını azaltın.

If possible, use it always short drilling tools. Otherwise, reduce your speeds to minimize vibration.

B

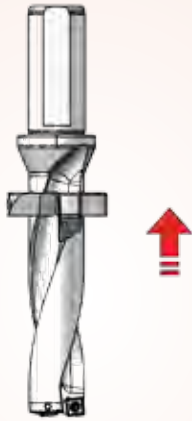

Mümkün olduğunca pah kırma halkasını şaft kısmına yakın montaj yap.

Get close to the mounting shaft of the chamfering ring as possible.

C

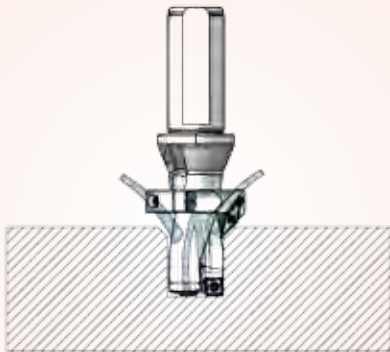

Daha iyi uç ömrü için harici soğutucu ve matkap ucu iç soğutucu uygulamak.

Apply external cooling and internal coolant drill for a better life for inserts.

Montaj Şekli / Mounting System

1



Matkap gövdesi üzerine pah kırma halkasını takın.

Put the chamfering ring to drill body.

2

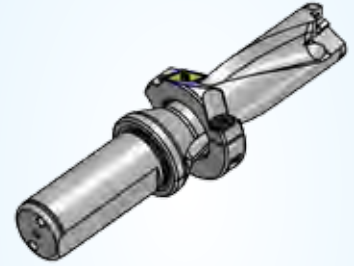

İstenilen konuma pah kırma halkasını kaydırın.

Please slide chamfering ring to the desired position.

3

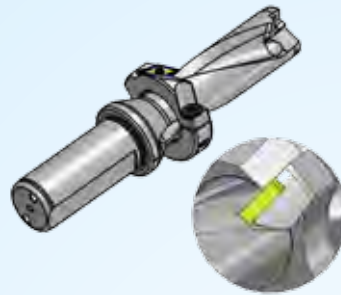

Pah kırma halkasını talaş akışına mani olmayacak şekilde helis başlangıcına denk getirin.

Please keep chamfering ring position which will not resist to fluiding chips and try to be equal to the helix start points.

4

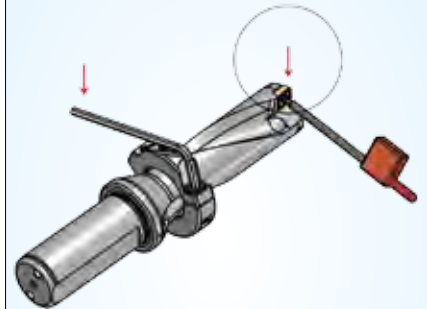

Pah kırma halkasını sıkın ve matkabin uçlarını takın.

Tightening the chamfering ring and put the drill insert.

Pah kırma halkasının doğru montaj şekli.
Proper installation of chamfering rings.

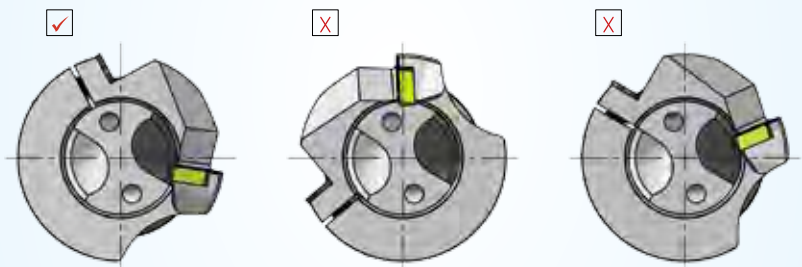

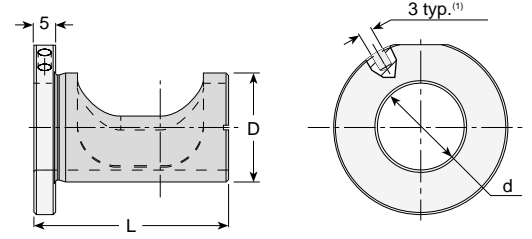

Takım Kodu
Ordering Code

Stok
Stock

Takım Ölçüleri (mm)
Dimension (mm)

Takım Kodu Ordering Code	Stok Stock	d	D	L
AET-2025	●	20	25	44
AET-2532	●	25	32	46
AET-3240	●	32	40	55

■⁽¹⁾Delik ince bir metal yardımıyla adaptörün radyal olarak ayarlanmasını kolaylaştırmak için kullanılır. / Holes for inserting a pin, used to facilitate radial adjustment of the sleeve (pin not supplied).

Frezeleme tezgahında takma uçlu matkabın nominal çapı, matkabın ekseninin, spindle eksenine göre ötelenmesiyle değiştirilebilir.

On a milling machine the drill's nominal diameter can be changed by shifting the drill's axis out of the tool spindle.

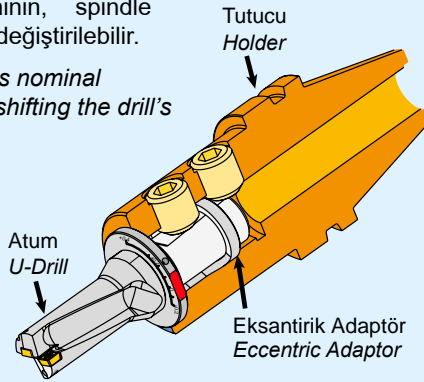
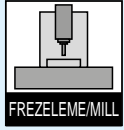

Radyal ayarlama pimi.
(Verilmeyecektir.)

Radial adjustment pin.
(not supplied)

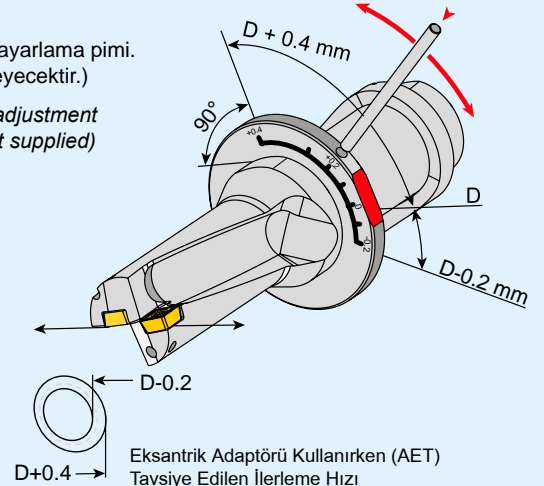

Eksantrik Adaptörü Kullanırken (AET)
Tavsiye Edilen İlerleme Hızı
Recommended Feed Rate When Using Eccentric Adaptor

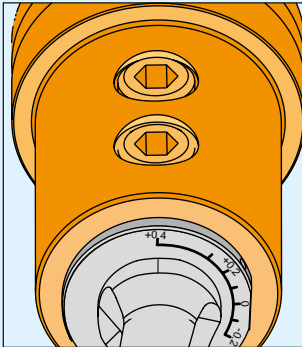
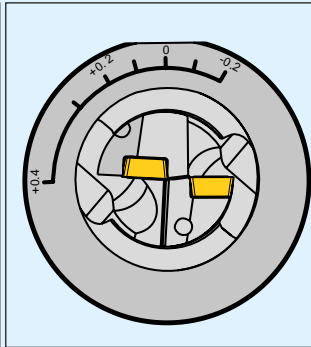
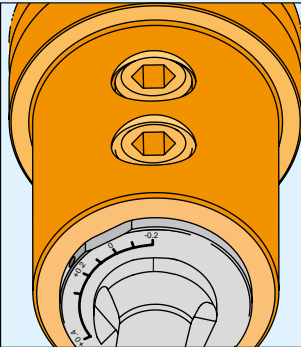
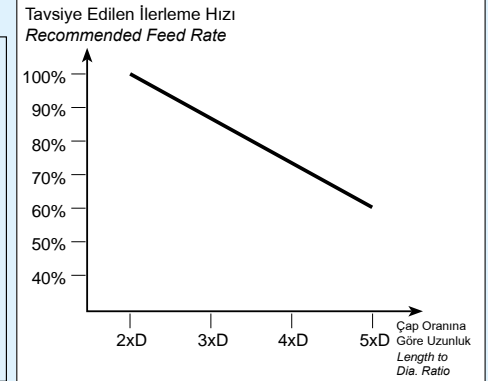

Delik Çapı
24.8 mm
Hole Diameter

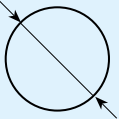

U-Drill Çapı = 25 mm
Drill Diameter = 25 mm

Delik Çapı
25 mm
Hole Diameter

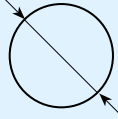

U-Drill Çapı = 25 mm
Drill Diameter = 25 mm

Delik Çapı
25.4 mm
Hole Diameter

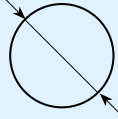

U-Drill Çapı = 25 mm
Drill Diameter = 25 mm

ATUM'un üzerindeki düz çizgi adaptörün sıfır rakamının üzerine konulmalıdır. AET'nin (eksantrik adaptörün) çevrilmesini kolaylaştırmak için AET'nin üzerindeki deliğe, metal bir çubuk ya da vida anahtarı yerleştirilebilir. AET'yi ayarlamadan önce tutucunun vidasını hafifçe çözün.

The adjustment markings should be located perpendicular to the flat on the circumference of the U-DRILL flange.

To facilitate the rotation of the adaptor, a metal rod or a screw key may be inserted into a hole on the eccentric adaptor flange. Unlock adaptor screw before adjusting adaptor.

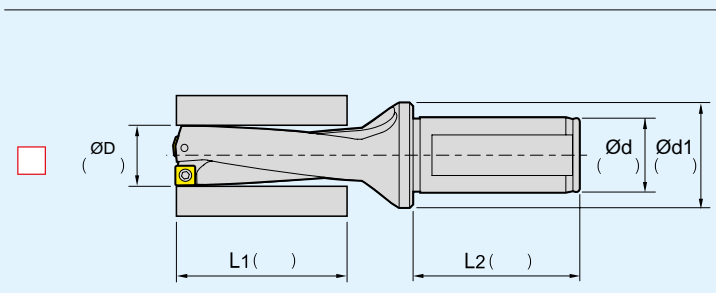
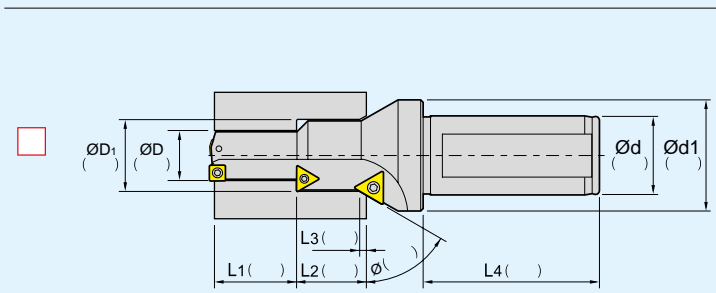
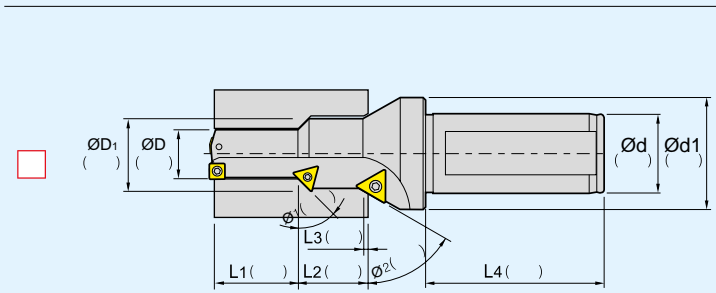
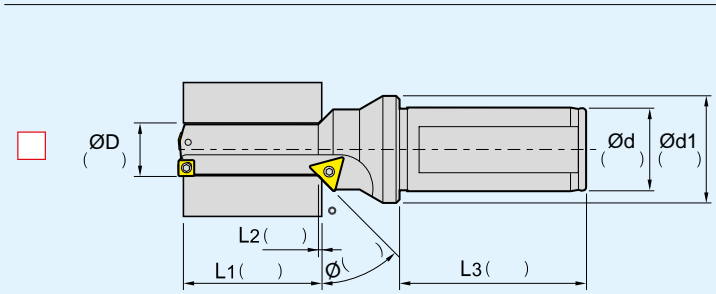
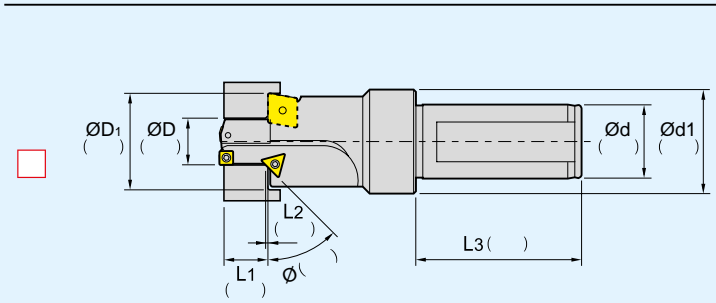

• Soğutma Tipi / Coolant type

Yağ Deliği Dalma Kısımında
Oil Hole On the Plunge Part

Yağ Deliği Şaft Kısımında
"Oil hole On the Shank"

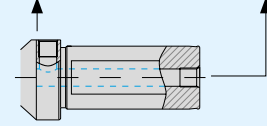

• Delik Tipi / Hole Type

Kapalı Delik
Blind Hole

Açık Delik
Thru Hole

• Şaft Tipleri / Types of Shank

Düz Tip
Flat Type

Weldon Tip
Weldon Type

Eğimli Yargı Tipi
Whistle Notch Type

• Yargı Bağlama Yeri / Location of Side Lock

Dış Uca Parelel (Standart)
Parallel to Peripheral Insert (Standard)

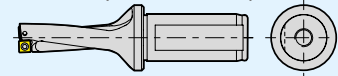

Dış Uca 90° Açılı
90° angle to peripheral insert

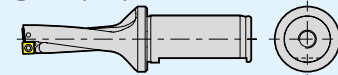

Dış Uca 150° Açılı
150° angle to peripheral insert

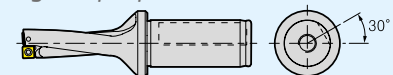

Dış Uca 180° Açılı
180° angle to peripheral insert

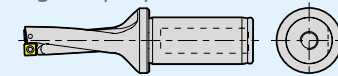

• Not / Note

• Şu Anki Kullanılan Takım

• Currently Using Tool

• Şu Anki Kesme Durumu

• Current Cutting Condition

- RPM ya da vc(m/min)

- RPM or vc(m/min)

- vf(mm/min) ya da fn(mm/rev)

- vf(mm/min) or fn(mm/rev)

- Kesme Derinliği

- Depth of Cut(mm)

• Ölçülen Standart Takım Ömrü

• Standard of Measuring Tool Life

• Şu Anki Kullanılan Makinalar

• Currently Using Machine

- İşleme Merkezi

- Machining Center

- Genel Torna

- General Lathe

- CNC Torna

- CNC Lathe



*konusulan
the spoken kalite...
quality...*

EKONOMİK KESİCİLER

EKONOMİK KESİCİLER
ECONOMIC CUTTING TOOLS



www.akkо.com.tr

Дистрибьютер ООО "Ресурс Плюс"
+7 (351) 247-74-40; info@rp-ural.ru



AKKO **A** **EK** **R** - **D2.25** x **20**

X **C** **.** **.** **10** **T3** **04**

2 Kesiş Stili / Cutter Style

EK : Ekonomik Kesici / Economic Cutting

3 Kesme Yönü / Cutting Direction

11 Kalınlık / Thickness

01	s = 1.59
T1	s = 1.98
02	s = 2.38
T2	s = 2.78
03	s = 3.18
T3	s = 3.97
04	s = 4.76
05	s = 5.56
06	s = 6.35
07	s = 7.94
09	s = 9.52

4 Delme Derinliği / Drilling Depth

5 Takım Çapı / Tool Diameter

6 Uç Şekli / Insert Form

X **Q**

8 Toleranslar / Tolerance Classes

	d	m	t
A	± 0.025	± 0.005	± 0.025
C	± 0.025	± 0.013	± 0.025
E	± 0.025	± 0.025	± 0.025
F	± 0.013	± 0.005	± 0.025
G	± 0.025	± 0.025	± 0.130
H	± 0.013	± 0.013	± 0.025
J	± 0.05-0.15	± 0.005	± 0.025
K	± 0.05-0.15	± 0.013	± 0.025
L	± 0.05-0.15	± 0.025	± 0.025
M	± 0.05-0.15	± 0.08-0.20	± 0.130
N	± 0.05-0.15	± 0.08-0.20	± 0.025
U	± 0.08-0.25	± 0.13-0.38	± 0.130

d : Daire Ölçüsü / Inscribed Circle
m : Şekle Göre / Refer to Figure
t : Kalınlık / Thickness

9 Uç Tipi / Type of Insert

A **J** **T**
 $\beta = 70-90^\circ$ $\beta = 70-90^\circ$ $\beta = 40-60^\circ$

B **M** **U**
 $\beta = 70-90^\circ$ $\beta = 40-60^\circ$

C **N** **W**
 $\beta = 70-90^\circ$ $\beta = 40-60^\circ$

F **Q** **X**
 $\beta = 40-60^\circ$ $\beta = 40-60^\circ$ Special / Özel

G **R**

H
 $\beta = 70-90^\circ$

7 Serbest Uç Açısı / Clearance Angle of Insert









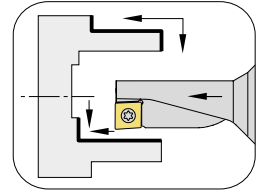
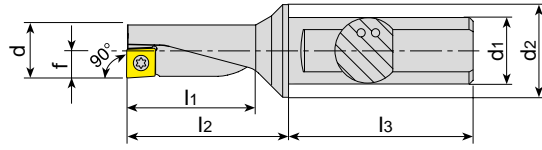











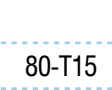

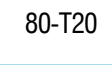

C

10 Kesme Kenar Uzunluğu / Cutting Edge Length

12 Köşe Konfigürasyonu / Corner Radius

01	r = 0.1	12	r = 1.2
02	r = 0.2	16	r = 1.6
04	r = 0.4	24	r = 2.4
08	r = 0.8		

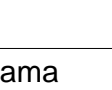

Takım Kodu Ordering Code	Stok Stock		Takım Ölçüleri (mm) Dimension (mm)							Kesici Uç Insert	Yedek Parçaları Spare Parts	
	R	L	d	d1	d2	l1	l2	l3	f	Sıkma Vidası Screw	Tork Anahtar Torx Key	
AEKR/L-D2.25X8 XC.. 040104	●	●	8	10	12	18	22	38	4			
AEKR/L-D2.25X10 XC.. 050204	●	●	10	12	16	22.5	27.5	42	5			
AEKR/L-D2.25X12 XC.. 060204	●	●	12	16	20	27	33	45	6			
AEKR/L-D2.25X14 XC.. 070304	●	●	14	16	20	31.5	38	45	7			
AEKR/L-D2.25X16 XC.. 080304	●	●	16	20	25	36	44	50	8			
AEKR/L-D2.25X18 XC.. 09T304	●	●	18	25	32	40.5	53.5	56	9			
AEKR/L-D2.25X20 XC.. 10T304	●	●	20	25	32	45	55	56	10			
AEKR/L-D2.25X25 XC.. 130404	●	●	25	32	40	56.5	69	60	12.5			
AEKR/L-D2.25X32 XC.. 170504	●	●	32	32	50	72	88	60	16			

R: Sağ/Right L: Sol/Left ● Stokta/In Stock ○ Stokta Yok/Non Stock Item
CRTZT-ISCR-TGTC-KRLY Ucuna Uygundur. / Compatible with CRTZT-ISCR-TGTC-KRLY Insert.

Sipariş Örneği/Ordering Example : 1 ad./pcs. AEKR-D2.25X8 XC.. 040104

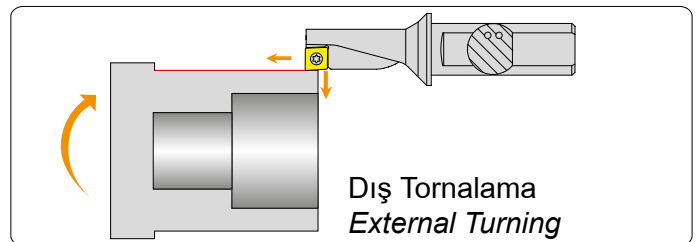
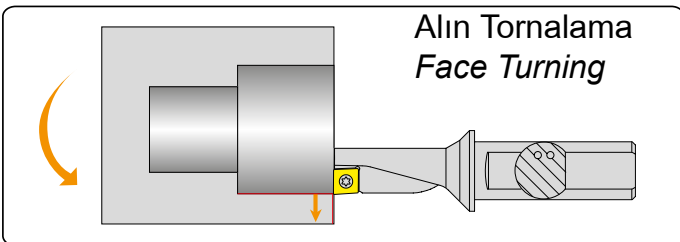
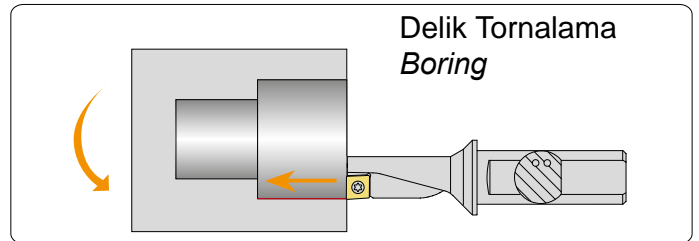
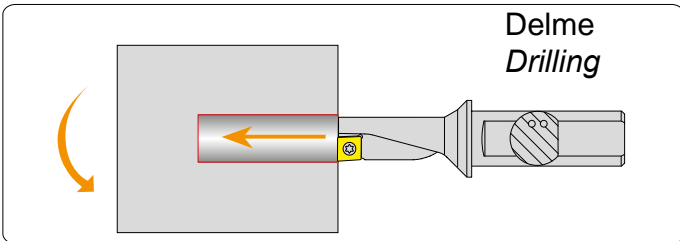
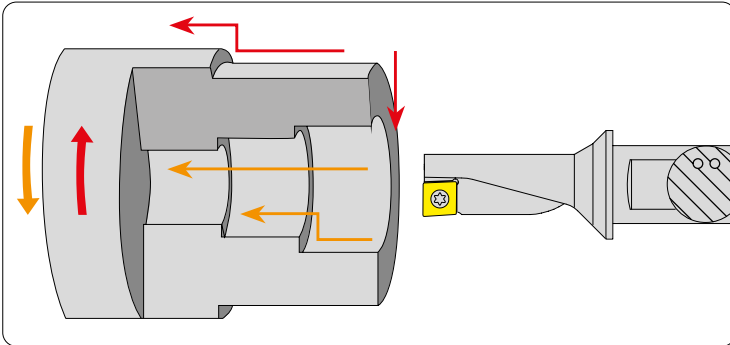

BARALAR

AYARLI DELİK İŞLEME BARALARI
ADJUSTABLE BORING HEADS

*konusulan
the spoken kalite...
quality...*

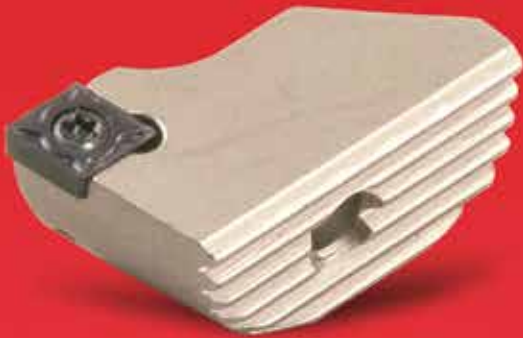

AKKO **A** **BH** **R** - **D18x22**

W16 - **L90** - **CC06**

2 Kesiş Stili / Cutter Style

BH : Delik İşleme / Boring Head

3 İşlem Tipi / Cutter Type

R : Kaba Baralama / Rough Boring
F : Hassas Baralama / Fine Boring

5 Montaj Formu / Assembly Form

W : Weldon

4 Ölçü Aralığı / Boring Range

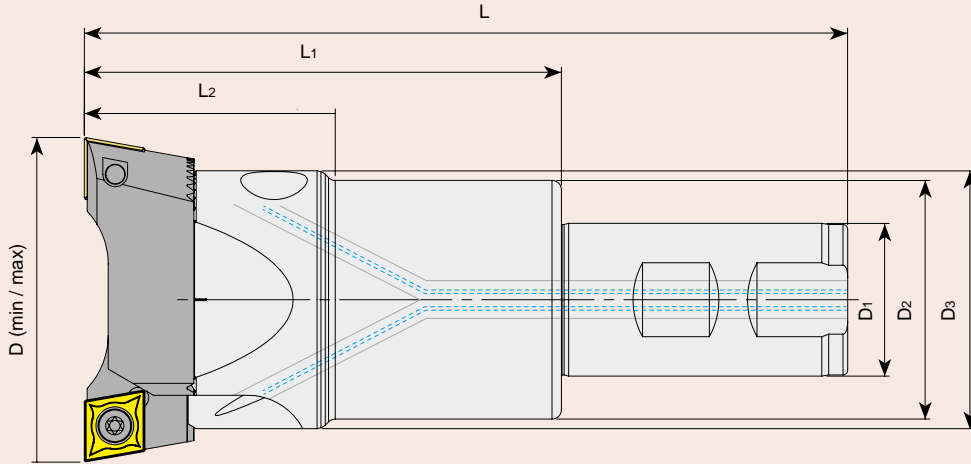

6 Takım Boyu / Tool Length

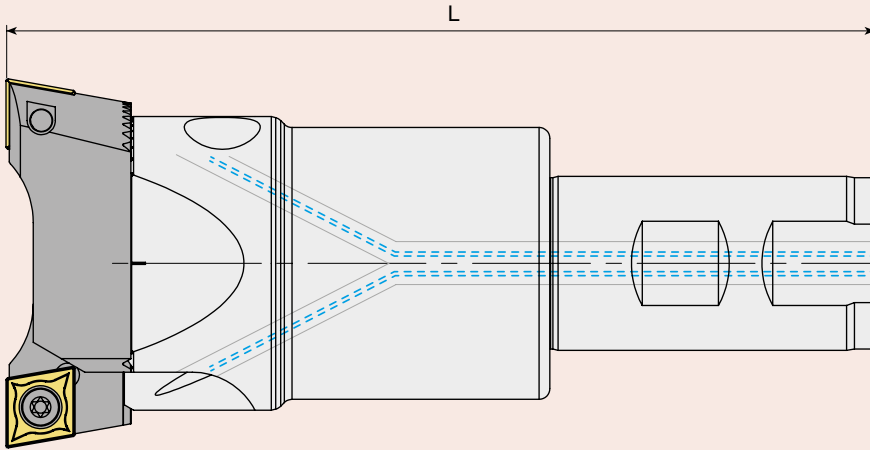

7 Kesici Uç / Insert

CC06 : CC.. 0602..
CC09 : CC.. 09T3..
CC12 : CC.. 1204..

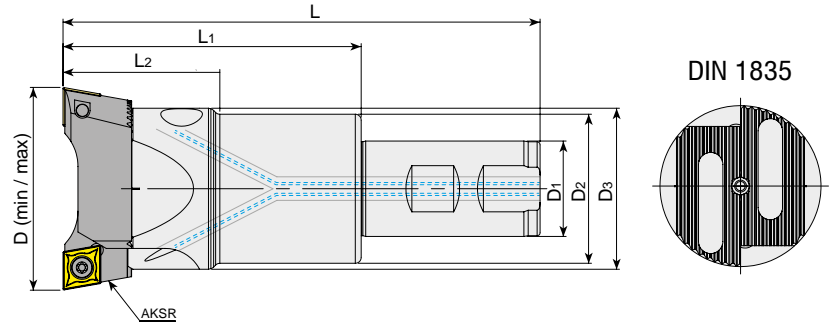

Takım Kodu Ordering Code	Stok Stock	Ölçü Aralığı Boring Range D (min/max)	Takım Ölçüleri (mm) Dimension (mm)						Kartuş Cartridge	Bara Gövde Takım Kodu Boring Head Body Code
			D ₁	D ₂	D ₃	L	L ₁	L ₂		
ABHR-D18x22-W16-L90-CC06	●	18-22	16	-	-	90	42	-	AK.. 18-22	ABHRS-D16x42-W16-L90
ABHR-D18x22-W16-L150-CC06	●	18-22	16	-	-	150	102	-		ABHRS-D16x102-W16-L150
ABHR-D18x22-W16-L200-CC06	●	18-22	16	-	-	200	152	-		ABHRS-D16x152-W16-L200
ABHR-D22x28-W20-L100-CC06	●	22-28	20	-	-	100	50	-	AK.. 22-28	ABHRS-D20x50-W20-L100
ABHR-D22x28-W20-L150-CC06	●	22-28	20	-	-	150	100	-		ABHRS-D20x100-W20-L150
ABHR-D22x28-W20-L200-CC06	●	22-28	20	-	-	200	150	-		ABHRS-D20x150-W20-L200
ABHR-D28x38-W20-L110-CC06	●	28-38	20	25	-	110	60	-	AK.. 28-38	ABHRS-D25x60-W20-L110
ABHR-D28x38-W20-L160-CC06	●	28-38	20	25	-	160	110	-		ABHRS-D25x110-W20-L160
ABHR-D28x38-W20-L230-CC06	●	28-38	20	25	-	230	180	-		ABHRS-D25x180-W20-L230
ABHR-D36x50-W25-L120-CC06	●	36-50	25	32	-	120	64	-	AK.. 36-50	ABHRS-D32X64-W25-L120
ABHR-D36x50-W25-L170-CC06	●	36-50	25	32	-	170	114	-		ABHRS-D32X114-W25-L170
ABHR-D36x50-W25-L250-CC06	●	36-50	25	32	-	250	194	-		ABHRS-D32X194-W25-L250
ABHR-D36x50-W25-L120-CC09	●	36-50	25	32	-	120	64	-	AK.. 36-50-09	ABHRS-D32X64-W25-L120
ABHR-D36x50-W25-L170-CC09	●	36-50	25	32	-	170	114	-		ABHRS-D32X114-W25-L170
ABHR-D36x50-W25-L250-CC09	●	36-50	25	32	-	250	194	-		ABHRS-D32X194-W25-L250
ABHR-D50x68-W32-L140-CC09	●	50-68	32	40	-	140	80	-	AK.. 50-68	ABHRS-D40x80-W32-L140
ABHR-D50x68-W32-L200-CC09	●	50-68	32	40	-	200	140	-		ABHRS-D40x140-W32-L200
ABHR-D50x68-W32-L280-CC09	●	50-68	32	40	-	280	220	-		ABHRS-D40x220-W32-L280
ABHR-D50x68-W32-L140-CC12	●	50-68	32	40	-	140	80	-	AK.. 50-68-12	ABHRS-D40x80-W32-L140
ABHR-D50x68-W32-L200-CC12	●	50-68	32	40	-	200	140	-		ABHRS-D40x140-W32-L200
ABHR-D50x68-W32-L280-CC12	●	50-68	32	40	-	280	220	-		ABHRS-D40x220-W32-L280
ABHR-D68x90-W32-L160-CC12	●	68-90	32	50	54	160	100	50	AK.. 68-90	ABHRS-D50x100-W32-L160
ABHR-D68x90-W32-L210-CC12	●	68-90	32	50	54	210	150	50		ABHRS-D50x150-W32-L210
ABHR-D68x90-W32-L280-CC12	●	68-90	32	50	54	280	220	50		ABHRS-D50x220-W32-L280
ABHR-D90x120-W32-L140-CC12	●	90-120	32	63	72	140	80	63	AK.. 90-120	ABHRS-D63x80-W32-L140
ABHR-D90x120-W40-L200-CC12	●	90-120	40	63	72	200	130	63		ABHRS-D63x130-W40-L200
ABHR-D90x120-W40-L300-CC12	●	90-120	40	63	72	300	230	63		ABHRS-D63x230-W40-L300
ABHR-D120x160-W40-L210-CC12	●	120-160	40	80	95	210	140	75	AK.. 120-160	ABHRS-D80x140-W40-L210
ABHR-D120x160-W40-L300-CC12	●	120-160	40	80	95	300	230	75		ABHRS-D80x230-W40-L300
ABHR-D160x200-W40-L210-B-CC12	●	160-200	40	80	95	210	140	75	AK.. 160-800	ABHRS-D80x140-W40-L210
ABHR-D160x200-W40-L300-B-CC12	●	160-200	40	80	95	300	230	75		ABHRS-D80x230-W40-L300

R: Sağ/Right L: Sol/Left ● Stokta/In Stock ○ Stokta Yok/Non Stock Item
Siparişte, gövde ve kartuş set olarak verilecektir. / When ordered, body and cartridge will be sent as set.

Sipariş Örneği/Ordering Example : 1 ad./pcs. ABHR-D18x22-W16-L90-CC06

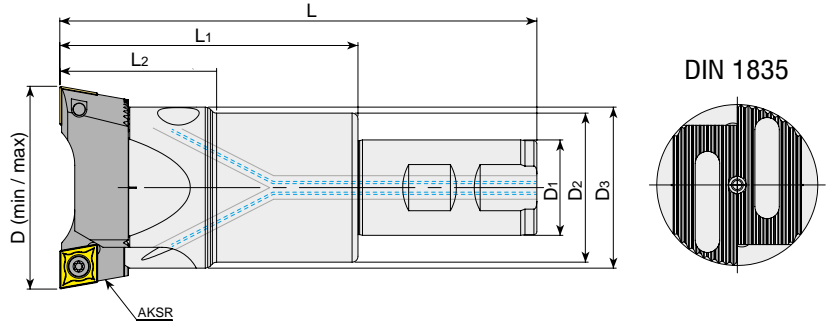

Takım Kodu Ordering Code	Stok Stock	Ölçü Aralığı Boring Range D (min/max)	Takım Ölçüleri (mm) Dimension (mm)					Yedek Parçaları Spare Parts					
			D ₁	D ₂	D ₃	L	L ₁	L ₂	Montaj Vidası Mounting Screw	Montaj Vida Anahtarı Allen Key	Pabuç Clamp	Ayar Vidası Adjusting Screw	Ayar Vida Anahtarı Allen Key
ABHRS-D16x42-W16-L90	●	18-22	16	-	-	90	42	-					
ABHRS-D16x102-W16-L150	●	18-22	16	-	-	150	102	-	2525-M3x14	AAL-02-2.5	ABKS-D16	2715-M3x4	
ABHRS-D16x152-W16-L200	●	18-22	16	-	-	200	152	-					
ABHRS-D20x50-W20-L100	●	22-28	20	-	-	100	50	-					
ABHRS-D20x100-W20-L150	●	22-28	20	-	-	150	100	-	2503-M4x15	AAL-03-3	ABKS-D20	2715-M3x5	AAL-09-1.5
ABHRS-D20x150-W20-L200	●	22-28	20	-	-	200	150	-					
ABHRS-D25x60-W20-L110	●	28-38	20	25	-	110	60	-					
ABHRS-D25x110-W20-L160	●	28-38	20	25	-	160	110	-	2503-M4x20	AAL-03-3	ABKS-D25	2715-M3x8	
ABHRS-D25x180-W20-L230	●	28-38	20	25	-	230	180	-					
ABHRS-D32X64-W25-L120	●	36-50	25	32	-	120	64	-					
ABHRS-D32X114-W25-L170	●	36-50	25	32	-	170	114	-	2504-M5x25	AAL-05-4	ABKS-D32	2702-M4x12	AAL-01-2
ABHRS-D32X194-W25-L250	●	36-50	25	32	-	250	194	-					
ABHRS-D40x80-W32-L140	●	50-68	32	40	-	140	80	-					
ABHRS-D40x140-W32-L200	●	50-68	32	40	-	200	140	-	2505-M6x30	AAL-07-5	ABKS-D40	2725-M5x14	
ABHRS-D40x220-W32-L280	●	50-68	32	40	-	280	220	-					AAL-02-2.5
ABHRS-D50x100-W32-L160	●	68-90	32	50	54	160	100	50					
ABHRS-D50x150-W32-L210	●	68-90	32	50	54	210	150	50	2506-M8x35	AAL-08-6	ABKS-D50	2725-M5x12	
ABHRS-D50x220-W32-L280	●	68-90	32	50	54	280	220	50					
ABHRS-D63x80-W32-L140	●	90-120	32	63	72	140	80	63					
ABHRS-D63x130-W40-L200	●	90-120	40	63	72	200	130	63	2508-M10x40	AAL-11-8	ABKS-D63	2703-M6x16	AAL-03-3
ABHRS-D63x230-W40-L300	●	90-120	40	63	72	300	230	63					
ABHRS-D80x140-W40-L210	●	120-160	40	80	95	210	140	75	2510-M12x40				
ABHRS-D80x230-W40-L300	●	120-160	40	80	95	300	230	75					
ABHRS-D80x140-W40-L210	●	160-200	40	80	95	210	140	75	2510-M12x40	AAL-12-10	ABKS-D80	2704-M8x25	AAL-05-4
ABHRS-D80x230-W40-L300	●	160-200	40	80	95	300	230	75					

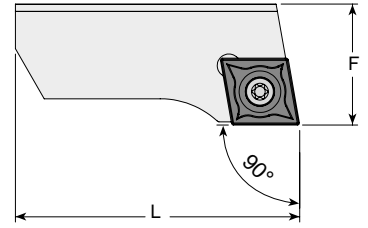

Takım Kodu Ordering Code	Stok Stock	Takım Ölçüleri (mm) Dimension (mm)		Kesici Uç Insert	Yedek Parçaları Spare Parts		
		Ölçü Aralığı Boring Range	F		L	Sıkma Vidası Screw	Tork Anahtar Torx Key
AKSR 18-22	●	18-22	9	15	CC.. 0602..	4008-M2.5x6	80-T08
AKSR 22-28	●	22-28	10	19			
AKSR 28-38	●	28-38	13	23			
AKSR 36-50	●	36-50	16	32	CC.. 09T3..	4015-M3.5x8	80-T15
AKSR 36-50-09	●	36-50	16	32			
AKSR 50-68	●	50-68	20	40			
AKSR 50-68-12	●	50-68	20	40	CC.. 1204..	1020-M5x11	80-T20
AKSR 68-90	●	68-90	23	54			
AKSR 90-120	●	90-120	28	70			
AKSR 120-160	●	120-160	32	95			
AKSR 160-800	●	160-800	32	120			

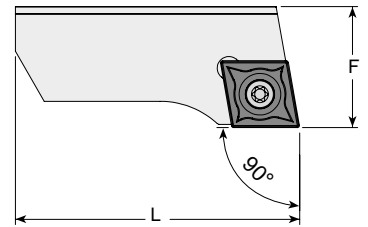

Takım Kodu Ordering Code	Stok Stock	Takım Ölçüleri (mm) Dimension (mm)		Kesici Uç Insert	Yedek Parçaları Spare Parts		
		Ölçü Aralığı Boring Range	F		L	Sıkma Vidası Screw	Tork Anahtar Torx Key
AKCR 28-38	●	28-38	12.8	23	CC.. 0602..	4008-M2.5x6	80-T08
AKCR 36-50	●	36-50	15.8	32			
AKCR 36-50-09	●	36-50	15.8	32			
AKCR 50-68	●	50-68	19.7	40	CC.. 09T3..	4015-M3.5x8	80-T15
AKCR 50-68-12	●	50-68	19.7	40			
AKCR 68-90	●	68-90	22.7	54			
AKCR 90-120	●	90-120	27.7	70	CC.. 1204..	1020-M5x11	80-T20
AKCR 120-160	●	120-160	31.7	95			
AKCR 160-800	●	160-800	31.7	120			

R: Sağ/Right L: Sol/Left ● Stokta/In Stock ○ Stokta Yok/Non Stock Item
ISO Ucuna Uygunudur. / Compatiple with ISO Insert.

Sipariş Örneği/Ordering Example : 1 ad./pcs. AKSR 18-22

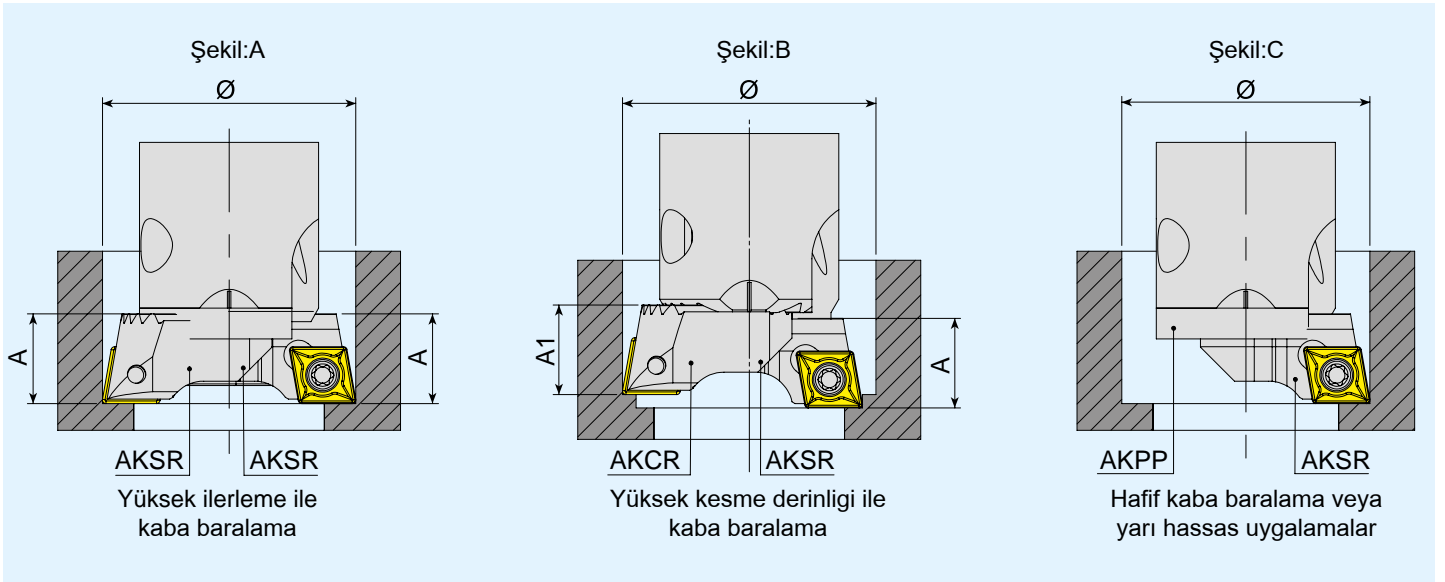

1. Kesici kenarların radyal ayarı, takım ölçme ekipmanı ile yapılmalıdır.
2. İki uçlu baralama takımı, ağır talaş kaldırma işlemini içeren kaba baralama işlemleri içindir.

Çift uçlu baralama takımı ile:

- Yüksek ilerleme oranında kaba baralama işlemleri için, aynı düzlemdeki iki AKSR kartuşu, aynı radyal mesafeye ayarlanır. (Şekil A)
- Aynı düzlemde olmayan bir AKCR kartuşu ve bir AKSR kartuşu yüksek derinlikte kaba baralama işlemleri için kullanılır. (Şekil B)
 - i. Kaba baralama işleminde, alınacak paso miktarı tam olarak ikiye bölünüp, düzgün bir kesim sağlanmış olur, ancak bu durumda tur başına ilerleme tek ağız olarak hesaplanmalıdır. ($f=f_1$)
 - ii. Hassas baralama işleminde, alınacak paso miktarı AKSR kartuş için ara kaba olarak ve AKCR kartuş için hassas bara olarak çaplar ayarlanır ve bu sayede bazı ara kaba işleme ihtiyaç kalmaz.
- 3. Tek kartuşlu baralama takımları, normal talaş kaldırma işlemini içeren kaba ve hassas baralama işlemleri içindir. Dişleri koruma plakası, AKPP daima kullanılmalıdır. (Şekil C)

1. Radial setting of the cutting edges should be carried out with tool presetting equipment.
2. Boring bars fitted with two insert pockets are for roughing operations involving heavy chip removal.

The double-insert boring bars include:

 - Two AKSR cartridges on the same plane with two cutting edges set at identical radial distance for high feed rate roughing operations. (fig. A)
 - An AKCR cartridge and an AKSR cartridge not on the same plane for high-depth roughing operations. (fig. B)
 - i. With the rough boring operation, this allows double the cutting width, using only a single feed rate. ($f=f_1$)
 - ii. With the finish boring operation, the cutting width is divided so that some of the intermediate machining can be omitted.
3. Boring bars fitted with a single cartridge are for roughing and finishing operations involving normal chip removal. The serrated surface protection plate AKPP should always be used (fig. C)



konusulan
the spoken kalite...
quality...

FREZELEME TAKIMLARI MILLING TOOLS



AKKO
A

1

EM

2

90

3

L

4

A

5

P

6

10

7

D12

8

W16

9

L100

10

Z01

11

H

12

2 Kesiş Stili / Cutter Style

FM: Yüzey Frezeleme Takımları - Face Milling Tools
EM: Alın ve Yüzey Parmak Frezeleri - End Face Milling Tools
CM: Pah Kırma Parmak Frezeleri - Chamfering End Milling Tools
HM: Helis Parmak Frezeleri - Helix End Milling Tools
TSM: T Kanal Frezeleri - T Slot Milling Tools
HFM: Yüksek İlerleme Frezeleme Takımları - High Feed Milling Tools
PMR: Küresel Uçlu Parmak Frezeleri - Ball Nose End Milling Tools
SDM: Disk Frezeler / Slot Disc Milling
CBM: Silindirik Alyan Başlı Vida Havşalarını Açma Frezeleri
Countersink Milling Tool for Cylindrical Allen Head Screws

3 Freze Yanaşma Açısı / Lead Angle

90° - 75° - 60° - 45°
20° - 15° - 11° - 5° - 0°

4 Freze Yanaşma Açısı / Lead Angle

L: Sol - Left
C: Baskı Pabucu - Clamp
S: Altık - Shim
CL: Baskı Pabuçlu Sol Yön - Left Way with Clamp
CS: Baskı Pabuçlu Altıklı - Clamp with Shim
CSL: Baskı Pabuçlu Altıklı Sol Yön - Left Way Clamp with Shim

7 Kesme Kenar Uzunluğu / Cutting Edge Length

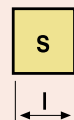
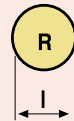
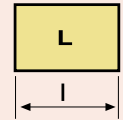
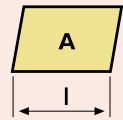

5 Uç Tipi / Insert Shape

C	D	E	K
L	R	S	T
V	W	A	B
H	M	O	P

6 Serbest Uç Açısı / Clearance angle of Insert

A	B	C
D	E	F
G	N	P

8 Takım Çapı / Tool Diameter

9 Montaj Formu ve Çapı / Assembly Form and Diameter

A, B, C, D;: ISO'ya göre montaj formu / Assembly form according to ISO
C: Silindirik Şaft / Cylindrical Shank
W: Weldon

10 Takım Boyu / Tool Length

11 Etkili Diş Adedi / Number of Effective Tooth

12 İçten Soğutmalı / With Coolant Hole

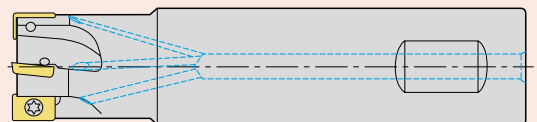

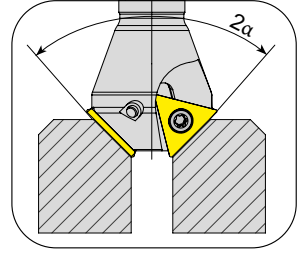
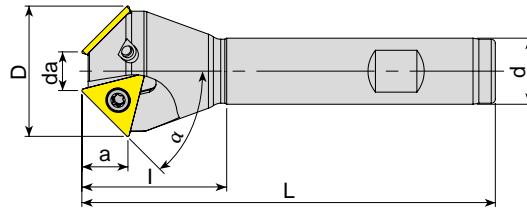

Takım Kodu Ordering Code	Stok Stock	Takım Ölçüleri (mm) Dimension (mm)							Kesici Uç Insert	Yedek Parçaları Spare Parts		
		α	da	D	d	L	l	Z		a	Sıkma Vidası Screw	Tork Anahtar Torx Key
ACM10-TC16-D17X22-W16-L90-Z01	●	10°	17	22	16	90	30	1	15.2			
ACM15-TC16-D17X24-W16-L90-Z01	●	15°	17	24	16	90	30	1	14.9			
ACM15-TC16-D22X29-W16-L100-Z01	●	15°	22	29	16	100	30	1	14.9			
ACM15-TC16-D30X37-W20-L100-Z02	●	15°	30	37	20	100	35	2	14.9			
ACM15-TC16-D35X42-W20-L100-Z03	●	15°	35	42	20	100	38	3	14.9			
ACM15-TC16-D52X59-W25-L110-Z03	●	15°	52	59	25	110	40	3	14.9			
ACM17.5-TC16-D17X25-W16-L90-Z01	●	17.5°	17	25	16	90	30	1	14.7			
ACM18.5-TC16-D21.3X30-W20-L100-Z02	●	18.5°	21.3	30	20	100	30	2	13.5			
ACM20-TC16-D12X22-W16-L100-Z01	●	20°	12	22	16	100	30	1	14.4			
ACM20-TC16-D17X27-W16-L100-Z01	●	20°	17	27	16	100	30	1	14.4			
ACM20-TC16-D23X33-W20-L100-Z02	●	20°	23	33	20	100	30	2	14.4			
ACM20-TC16-D28X38-W20-L100-Z02	●	20°	28	38	20	100	35	2	14.4			
ACM20-TC16-D35X45-W20-L100-Z03	●	20°	35	45	20	100	40	3	14.4			
ACM20-TC16-D39X49-W20-L100-Z03	●	20°	39	49	20	100	40	3	14.4			
ACM20-TC16-D45X55-W25-L110-Z03	●	20°	45	55	25	110	40	3	14.4			
ACM20-TC16-D51X61-W25-L110-Z03	●	20°	51	61	25	110	40	3	14.4			
ACM22.5-TC16-D17X28-W16-L100-Z01	●	22.5°	17	28	16	100	30	1	14.2			
ACM25-TC16-D17X29-W16-L100-Z01	●	25°	17	29	16	100	30	1	13.9			
ACM30-TC16-D6X20-W16-L100-Z01	●	30°	6	20	16	100	30	1	13.3			
ACM30-TC16-D15X30-W16-L100-Z01	●	30°	15	30	16	100	30	1	13.3			
ACM30-TC16-D17.5X32.5-W20-L100-Z02	●	30°	17.5	32.5	20	100	30	2	13.3			
ACM30-TC16-D20X35-W16-L100-Z02	●	30°	20	35	16	100	35	2	13.3			
ACM30-TC16-D30X45-W20-L100-Z02	●	30°	30	45	20	100	40	2	13.3			
ACM30-TC16-D35X50-W20-L100-Z03	●	30°	35	50	20	100	40	3	13.3			
ACM30-TC16-D45X60-W25-L110-Z03	●	30°	45	60	25	110	40	3	13.3			
ACM45-TC09-D7X18-W16-L100-Z02	●	45°	7	18	16	100	25	2	5.9	TC.T 090204	3007-M2.2x5	80-T07
ACM45-TC11-D11X24-W16-L100-Z02	●	45°	11	24	16	100	25	2	6.9	TC.T 110204	3008-M2.5x6	80-T08
ACM45-TC16-D5X26-W16-L100-Z01	●	45°	5	26	16	100	30	1	10.8	TC.T 16T304	4015-M3.5x9	80-T15
ACM45-TC16-D10X31-W16-L100-Z02	●	45°	10	31	16	100	35	2	10.8			
ACM45-TC16-D10X31-W20-L100-Z02	●	45°	10	31	20	100	35	2	10.8			
ACM45-TC16-D18X39-W16-L100-Z02	●	45°	18	39	16	100	40	2	10.8			
ACM45-TC16-D18X39-W20-L100-Z02	●	45°	18	39	20	100	40	2	10.8			
ACM45-TC16-D20X41-W20-L100-Z02	●	45°	20	41	20	100	40	2	10.8			
ACM45-TC16-D30X51-W20-L100-Z02	●	45°	30	51	20	100	40	2	10.8			
ACM55-TC16-D16X40-W20-L100-Z03	●	55°	16	40	20	100	40	3	8.7			
ACM62-TC16-D14X40-W20-L100-Z03	●	62°	14	40	20	100	40	3	7.1			
ACM72-TC16-D14X42-W20-L100-Z03	●	72°	14	42	20	100	40	3	4.6			

R: Sağ/Right L: Sol/Left ● Stokta/In Stock ○ Stokta Yok/Non Stock Item
ISO Ucuna Uygunudur. / Compatible with ISO Insert.

Sipariş Örneği/Ordering Example : 1 ad./pcs. ACM10-TC16-D17X22-W16-L90-Z01
Kesme Hesabı : S 271 / Cutting Calculation : P 271

> S-SİSTEM PAH FREZELER
S-SYSTEM CHAMFERING END MILLS

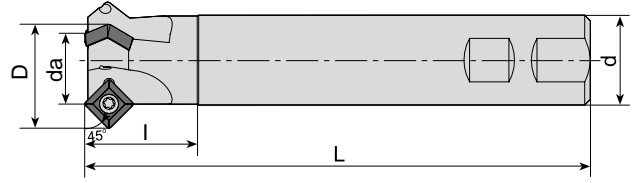

Takım Kodu Ordering Code	Stok Stock	Takım Ölçüleri (mm) Dimension (mm)								Kesici Uç Insert	Yedek Parçaları Spare Parts	
		α	da	D	d	L	l	Z	a		Sıkma Vidası Screw	Tork Anahtar Torx Key
ACM45-SP1104-D12x26-W20-L150-Z01	●	45°	12	26	20	150	30	1	-	SPGT 110408	1515-M4x11	80-T15
ACM45-SP1104-D25x39-W25-L150-Z02	●	45°	25	39	25	150	35	2	-			
ACM45-SP1104-D32x46-W32-L150-Z03	●	45°	32	46	32	150	40	3	-			

ZCC Ucuna Uygundur. / Compatible with ZCC Insert.

> HELİS PAH FREZELEME TAKIMLARI
HELIX CHAMFER MILLING TOOLS

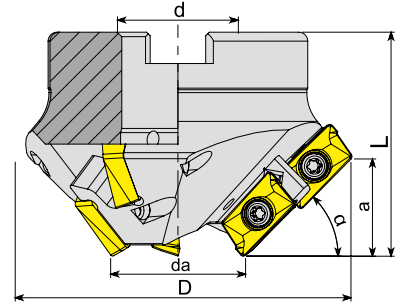

Takım Kodu Ordering Code	Stok Stock	Takım Ölçüleri (mm) Dimension (mm)								Kesici Uç Insert	Yedek Parçaları Spare Parts	
		Z		α	da	D	d	a	L		Sıkma Vidası Screw	Tork Anahtar Torx Key
		Toplam Total	Etkili Effective									
AHM15-AP16-D35x93-A27-Z0306-H	●	6	3	15	35	93	27	8	50	AP.. 1604..	4015-M4x11	80-T15
AHM30-AP16-D35x87-A27-Z0306-H	●	6	3	30	35	87	27	15	50			
AHM45-AP16-D35x77-A27-Z0306-H	●	6	3	45	35	77	27	21.5	50			
AHM60-AP16-D35x65-A22-Z0306-H	●	6	3	60	35	65	22	26.5	50			
AHM75-AP16-D35x50-A22-Z0306-H	●	6	3	75	35	50	22	29.5	50			

R: Sağ/Right L: Sol/Left ● Stokta/In Stock ○ Stokta Yok/Non Stock Item
ISO Ucuna Uygundur. / Compatible with ISO Insert.

Sipariş Örneği/Ordering Example : 1 ad./pcs. ACM45-SP1104-D12x26-W20-L150-Z01
Kesme Hesabı : S 271 / Cutting Calculation : P 271

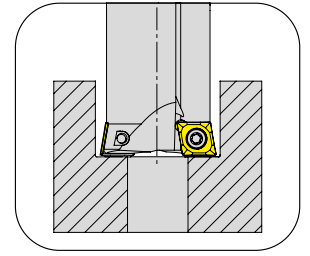
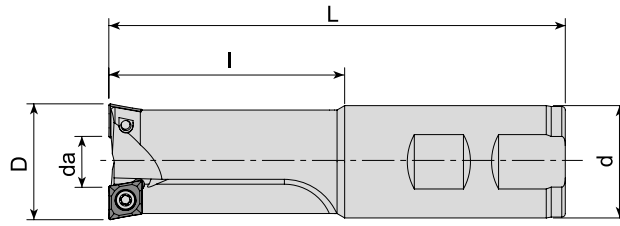

Takım Kodu Ordering Code	Stok Stock	Takım Ölçüleri (mm) Dimension (mm)						Kesici Uç Insert	Yedek Parçaları Spare Parts	
		da	D	d	l	L	Kullanılan Vidalar For Screws		Sıkma Vidası Screw	Tork Anahtar Torx Key
ACBM-CC06-D17X6-W16-L150-Z02	●	6	17	16	30	150	-	CC.. 060204	3008-M2.5x6	80-T08
ACBM-CC06-D18X7-W16-L100-Z02-H	●	7	18	16	32	100	M10			
ACBM-CC06-D18X7-W16-L160-Z02-H	●	7	18	16	32	160	M10			
ACBM-CC06-D20X9-W20-L100-Z02-H	●	9	20	20	40	100	M12			
ACBM-CC06-D20X9-W20-L160-Z02-H	●	9	20	20	38	160	M12	CC.. 09T304	4015-M3.5x9	80-T15
ACBM-CC09-D26X8.5-W25-L130-Z02-H	●	8.5	26	25	50	130	M16			
ACBM-CC09-D26X8.5-W25-L200-Z02	●	8.5	26	25	50	200	M16			
ACBM-CC09-D33X15.5-W32-L130-Z02-H	●	15.5	33	32	65	130	M20			
ACBM-CC09-D33X15.5-W32-L200-Z02	●	15.5	33	32	65	200	M20	SP.. 060204	3007-M2.2x5	80-T07
ACBM-SP06-D15X4-W16-L160-Z02-H	●	4	15	16	80	160	M8			

R: Sağ/Right L: Sol/Left ● Stokta/In Stock ○ Stokta Yok/Non Stock Item
ISO Ucuna Uygundur. / Compatible with ISO Insert.

Sipariş Örneği/Ordering Example : 1 ad./pcs. ACBM-CC06-D17X6-W16-L150-Z02
Kesme Hesabı : S 271 / Cutting Calculation : P 271



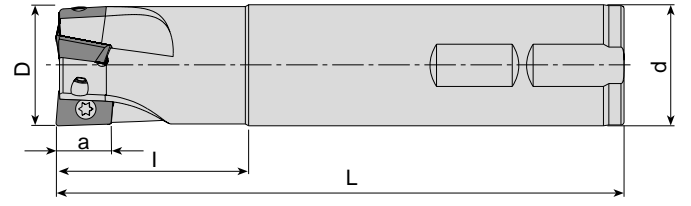







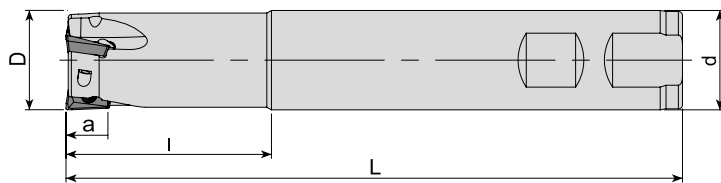

Takım Kodu Ordering Code	Stok Stock	Takım Ölçüleri (mm) Dimension (mm)						Kesici Uç Insert	Yedek Parçaları Spare Parts	
		D	Z	d	L	l	a		Sıkma Vidası Screw	Tork Anahtar Torx Key
AEM90-AD1505-D25-W25-L150-Z02	●	25	2	25	150	50	15	AD.. 1505..	1515-M4x9	80-T15
AEM90-AD1505-D30-W25-L150-Z03	●	30	3	25	150	40	15			
AEM90-AD1505-D32-W32-L150-Z03	●	32	3	32	150	50	15			

R: Sağ/Right L: Sol/Left ● Stokta/In Stock ○ Stokta Yok/Non Stock Item
ISCR Ucuna Uygundur. / Compatiple with ISCR Insert.

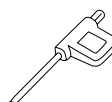
Sipariş Örneği/Ordering Example : 1 ad./pcs. AEM90-AD1505-D25-W25-L150-Z02
Kesme Hesabı : S 271 / Cutting Calculation : P 271



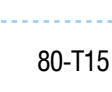

Takım Kodu Ordering Code	Stok Stock	Takım Ölçüleri (mm) Dimension (mm)						Kesici Uç Insert	Yedek Parçaları Spare Parts	
		D	Z	d	L	l	a		Sıkma Vidası Screw	Tork Anahtar Torx Key
AEM90-AD10T3-D16-W16-L100-Z02-H	●	16	2	16	100	30	10			
AEM90-AD10T3-D16-W16-L150-Z02	●	16	2	16	150	40	10			
AEM90-AD10T3-D16-C16-L200-Z02	●	16	2	16	200	50	10			
AEM90-AD10T3-D20-W20-L70-Z03	●	20	3	20	70	30	10			
AEM90-AD10T3-D20-W20-L100-Z03-H	●	20	3	20	100	30	10			
AEM90-AD10T3-D20-W20-L150-Z03	●	20	3	20	150	30	10			
AEM90-AD10T3-D20-C20-L150-Z03	●	20	3	20	150	40	10			
AEM90-AD10T3-D20-C20-L200-Z03	●	20	3	20	200	40	10			
AEM90-AD10T3-D25-W25-L100-Z03-H	●	25	3	25	100	30	10			
AEM90-AD10T3-D25-W25-L100-Z04-H	●	25	4	25	100	30	10			
AEM90-AD10T3-D25-W25-L150-Z03	●	25	3	25	150	50	10			
AEM90-AD1204-D20-W20-L150-Z02	●	20	2	20	150	50	12			
AEM90-AD1204-D25-W25-L150-Z03	●	25	3	25	150	50	12			
AEM90-AD1204-D32-W32-L150-Z04	●	32	4	32	150	50	12			
AEM90-AD1606-D25-W25-L150-Z02	●	25	2	25	150	50	15			
AEM90-AD1606-D32-W32-L150-Z03	●	32	3	32	150	50	15			

R: Sağ/Right L: Sol/Left ● Stokta/In Stock ○ Stokta Yok/Non Stock Item
WLTR Ucuna Uygunudur. / Compatible with WLTR Insert.

Sipariş Örneği/Ordering Example : 1 ad./pcs. AEM90-AD10T3-D16-W16-L100-Z02-H
Kesme Hesabı : S 271 / Cutting Calculation : P 271



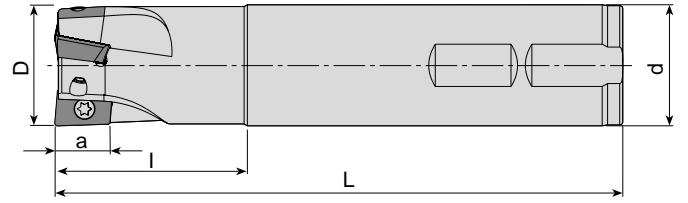

Takım Kodu Ordering Code	Stok Stock	Takım Ölçüleri (mm) Dimension (mm)						Kesici Uç Insert	Yedek Parçaları Spare Parts	
		D	Z	d	L	l	a		Sıkma Vidası Screw	Tork Anahtar Torx Key
AEM90-AD1003-D16-C16-L150-Z02	●	16	2	16	150	30	8	ADMT 1003..	3008-M2.5x6	80-T08
AEM90-AD1003-D17-C16-L150-Z02	●	17	2	16	150	25	8			
AEM90-AD1003-D20-C20-L200-Z03	●	20	3	20	200	50	8			
AEM90-AD1003-D21-C20-L200-Z03	●	21	3	20	200	25	8			
AEM90-AD1003-D25-C25-L200-Z03	●	25	3	25	200	50	8			
AEM90-AD1003-D26-C25-L150-Z03	●	26	3	25	150	30	8			
AEM90-AD1003-D26-C25-L200-Z03	●	26	3	25	200	30	8			
AEM90-AD1505D-D25-W25-L150-Z02	●	25	2	25	150	50	14.3	ADKT 150508	4015-M4x9	80-T15
AEM90-AD1505D-D32-W32-L150-Z03	●	32	3	32	150	50	14.3		4015-M4x11	

DJT Ucuna Uygun. / Compatible with DJT Insert.

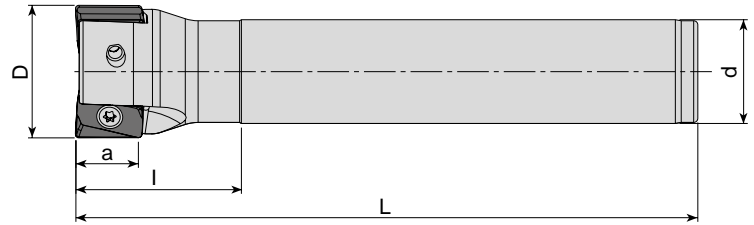

Takım Kodu Ordering Code	Stok Stock	Takım Ölçüleri (mm) Dimension (mm)						Kesici Uç Insert	Yedek Parçaları Spare Parts	
		D	Z	d	L	l	a		Sıkma Vidası Screw	Tork Anahtar Torx Key
AEM90-AN11-D22-W20-L150-Z02	●	22	2	20	150	30	11	ANGX 110508	4010-M3x8	80-T10
AEM90-AN11-D25-W25-L150-Z02	●	25	2	25	150	40	11			
AEM90-AN11-D25-C25-L200-Z02	●	25	2	25	200	40	11			
AEM90-AN11-D26-W25-L150-Z02	●	26	2	25	150	40	11			
AEM90-AN11-D28-W25-L150-Z02	●	28	2	25	150	25	11			
AEM90-AN11-D32-W32-L150-Z03	●	32	3	32	150	50	11			
AEM90-AN11-D32-C32-L200-Z03	●	32	3	32	200	50	11			
AEM90-AN11-D40-W32-L150-Z04	●	40	4	32	150	40	11			

R: Sağ/Right L: Sol/Left ● Stokta/In Stock ○ Stokta Yok/Non Stock Item
ZCC Ucuna Uygun. / Compatible with ZCC Insert.

Sipariş Örneği/Ordering Example : 1 ad./pcs. AEM90-AD1003-D16-C16-L150-Z02
Kesme Hesabı : S 271 / Cutting Calculation : P 271

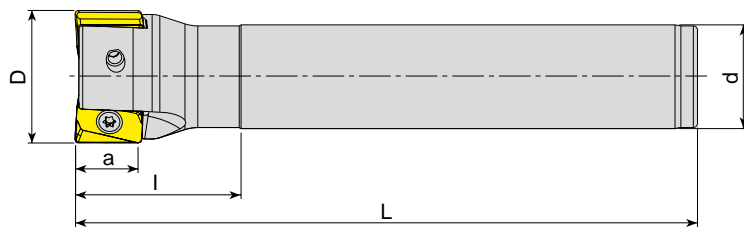

Takım Kodu Ordering Code	Stok Stock	Takım Ölçüleri (mm) Dimension (mm)						Kesici Uç Insert	Yedek Parçaları Spare Parts	
		D	Z	d	L	l	a		Sıkma Vidası Screw	Tork Anahtar Torx Key
AEM90-AN1607-D32-C25-L150-Z02	●	32	2	25	150	50	15	AN.X 1607	1515-M4x11	80-T15
AEM90-AN1607-D40-C32-L150-Z03	●	40	3	32	150	50	15			

TGTC Ucuna Uygundur. / Compatible with TGTC Insert.

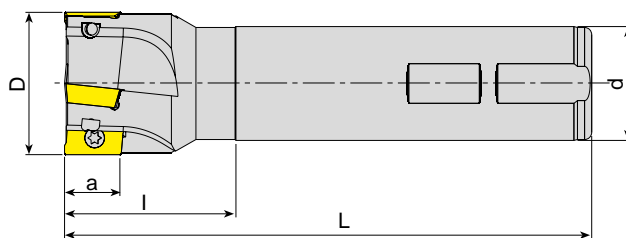





Takım Kodu Ordering Code	Stok Stock	Takım Ölçüleri (mm) Dimension (mm)						Kesici Uç Insert	Yedek Parçaları Spare Parts	
		D	Z	d	L	l	a		Sıkma Vidası Screw	Tork Anahtar Torx Key
AEM90-AP06-D10-C10-L120-Z02	●	10	2	10	120	20	5.6	APMT 0602.. KRILY UCUNA UYGUNDUR. FOR KRILY INSERT.	3006-M1.8x4	80-T06
AEM90-AP06-D12-C12-L120-Z02	●	12	2	12	120	20	5.6			
AEM90-AP0903-D16-C16-L150-Z02	●	16	2	16	150	30	9	APMT 0903.. KRILY UCUNA UYGUNDUR. FOR KRILY INSERT.	3008-M2.5x6	80-T08
AEM90-AP0903-D17-C16-L150-Z02	●	17	2	16	150	30	9			
AEM90-AP0903-D20-C20-L150-Z02	●	20	2	20	150	30	9	KRILY UCUNA UYGUNDUR. FOR KRILY INSERT.	3008-M2.5x6	80-T08
AEM90-AP0903-D21-C20-L150-Z02	●	21	2	20	150	30	9			
AEM90-AP0903-D25-C25-L150-Z03	●	25	3	25	150	30	9	APKT 09T3.. TGTC UCUNA UYGUNDUR. FOR TGTC INSERT.	3008-M2.5x6	80-T08
AEM90-AP09-D16-C16-L100-Z02-H	●	16	2	16	100	30	8.8			
AEM90-AP09-D16-C15-L150-Z02	●	16	2	15	150	25	8.8	APKT 09T3.. TGTC UCUNA UYGUNDUR. FOR TGTC INSERT.	3008-M2.5x6	80-T08
AEM90-AP09-D16-W16-L150-Z02-H	●	16	2	16	150	25	8.8			
AEM90-AP09-D16-C16-L200-Z02-H	●	16	2	16	200	100	8.8	TGTC UCUNA UYGUNDUR. FOR TGTC INSERT.	3008-M2.5x6	80-T08
AEM90-AP09-D17-C16-L150-Z02	●	17	2	16	150	25	8.8			
AEM90-AP09-D20-C20-L150-Z03-H	●	20	3	20	150	50	8.8	AP. 1003.. ISO UCUNA UYGUNDUR. FOR ISO INSERT.	3008-M2.5x5	80-T08
AEM90-AP09-D20-C20-L200-Z03-H	●	20	3	20	200	100	8.8			
AEM90-AP09-D20-C20-L250-Z02-H	●	20	2	20	250	150	8.8	AP. 1003.. ISO UCUNA UYGUNDUR. FOR ISO INSERT.	3008-M2.5x5	80-T08
AEM90-AP09-D21-C20-L150-Z03	●	21	3	20	150	25	8.8			
AEM90-AP09-D26-C25-L150-Z04	●	26	4	25	150	30	8.8	AP. 1003.. ISO UCUNA UYGUNDUR. FOR ISO INSERT.	3008-M2.5x5	80-T08
AEM90-AP10-D12-W16-L100-Z01-H	●	12	1	16	100	30	10			
AEM90-AP10-D12-W16-L150-Z01	●	12	1	16	150	38	10	AP. 1003.. ISO UCUNA UYGUNDUR. FOR ISO INSERT.	3008-M2.5x5	80-T08
AEM90-AP10-D14-W16-L100-Z01-H	●	14	1	16	100	30	10			

R: Sağ/Right L: Sol/Left ● Stokta/In Stock ○ Stokta Yok/Non Stock Item

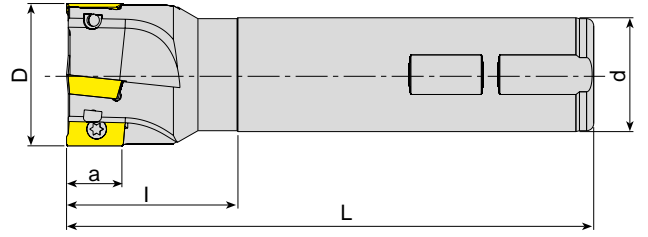
Sipariş Örneği/Ordering Example : 1 ad./pcs. AEM90-AN1607-D32-C25-L150-Z02

Kesme Hesabı : S 271 / Cutting Calculation : P 271



Takım Kodu Ordering Code	Stok Stock	Takım Ölçüleri (mm) Dimension (mm)						Kesici Uç Insert	Yedek Parçaları Spare Parts	
		D	Z	d	L	l	a		Sıkma Vidası Screw	Tork Anahtar Torx Key
AEM90-AP10-D14-W16-L150-Z01	●	14	1	16	150	38	10	 AP.. 1003.. ISO UCUNA UYGUNDUR. <i>FOR ISO INSERT.</i>	 3008-M2.5x6	 80-T08
AEM90-AP10-D16-C16-L100-Z02-H	●	16	2	16	100	30	10			
AEM90-AP10-D16-W16-L100-Z02-H	●	16	2	16	100	30	10			
AEM90-AP10-D16-C16-L120-Z02-H	●	16	2	16	120	30	10			
AEM90-AP10-D16-C16-L150-Z02	●	16	2	16	150	50	10			
AEM90-AP10-D16-C16-L150-Z02-H	●	16	2	16	150	50	10			
AEM90-AP10-D16-W16-L150-Z02	●	16	2	16	150	50	10			
AEM90-AP10-D16-C16-L200-Z02	●	16	2	16	200	100	10			
AEM90-AP10-D16-C16-L200-Z02-H	●	16	2	16	200	100	10			
AEM90-AP10-D16-C16-L250-Z02	●	16	2	16	250	50	10			
AEM90-AP10-D18-W16-L100-Z02-H	●	18	2	16	100	30	10			
AEM90-AP10-D18-W16-L150-Z02	●	18	2	16	150	30	10			
AEM90-AP10-D20-C20-L100-Z03-H	●	20	3	20	100	30	10			
AEM90-AP10-D20-W20-L100-Z03-H	●	20	3	20	100	30	10			
AEM90-AP10-D20-C20-L120-Z03-H	●	20	3	20	120	30	10			
AEM90-AP10-D20-C20-L150-Z03	●	20	3	20	150	50	10			
AEM90-AP10-D20-C20-L150-Z03-H	●	20	3	20	150	50	10			
AEM90-AP10-D20-W20-L150-Z03	●	20	3	20	150	50	10			
AEM90-AP10-D20-C20-L200-Z02	●	20	2	20	200	100	10			
AEM90-AP10-D20-C20-L200-Z03-H	●	20	3	20	200	100	10			
AEM90-AP10-D20-C20-L250-Z02	●	20	2	20	250	150	10			
AEM90-AP10-D20-C20-L250-Z02-H	●	20	2	20	250	150	10			
AEM90-AP10-D21-W20-L150-Z03	●	21	3	20	150	30	10			
AEM90-AP10-D22-W20-L100-Z03-H	●	22	3	20	100	30	10			
AEM90-AP10-D22-W20-L150-Z03	●	22	3	20	150	30	10			
AEM90-AP10-D23-W20-L150-Z03	●	23	3	20	150	30	10			
AEM90-AP10-D24-W20-L150-Z03	●	24	3	20	150	30	10			
AEM90-AP10-D25-W25-L100-Z04-H	●	25	4	25	100	30	10			
AEM90-AP10-D25-C25-L100-Z03-H	●	25	3	25	100	30	10			
AEM90-AP10-D25-W25-L100-Z03-H	●	25	3	25	100	30	10			
AEM90-AP10-D25-C25-L120-Z03-H	●	25	3	25	120	30	10			
AEM90-AP10-D25-C25-L150-Z03	●	25	3	25	150	50	10			
AEM90-AP10-D25-W25-L150-Z03	●	25	3	25	150	50	10			
AEM90-AP10-D25-C25-L200-Z02	●	25	2	25	200	100	10			
AEM90-AP10-D25-C25-L200-Z03	●	25	3	25	200	100	10			
AEM90-AP10-D25-C25-L250-Z02	●	25	2	25	250	100	10			

R: Sağ/Right L: Sol/Left ● Stokta/In Stock ○ Stokta Yok/Non Stock Item





Sipariş Örneği/Ordering Example : 1 ad./pcs. AEM90-AP10-D14-W16-L150-Z01

Kesme Hesabı : S 271 / Cutting Calculation : P 271

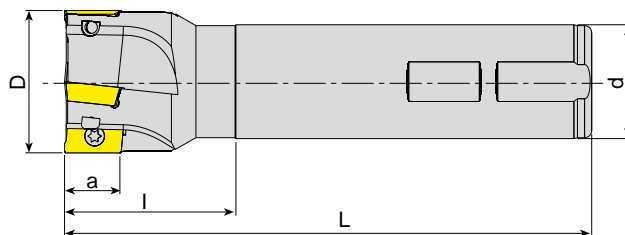

www.akkо.com.tr



Takım Kodu Ordering Code	Stok Stock	Takım Ölçüleri (mm) Dimension (mm)						Kesici Uç Insert	Yedek Parçaları Spare Parts	
		D	Z	d	L	l	a		Sıkma Vidası Screw	Tork Anahtar Torx Key
AEM90-AP10-D30-C25-L100-Z04-H	●	30	4	25	100	30	10	 AP.. 1003.. ISO UCUNA UYGUNDUR. FOR ISO INSERT.		
AEM90-AP10-D30-C25-L120-Z04-H	●	30	4	25	120	30	10			
AEM90-AP10-D30-C25-L150-Z04	●	30	4	25	150	30	10			
AEM90-AP10-D32-C25-L100-Z04-H	●	32	4	25	100	35	10			
AEM90-AP10-D32-C25-L120-Z04-H	●	32	4	25	120	35	10			
AEM90-AP10-D32-C25-L150-Z04	●	32	4	25	150	35	10			
AEM90-AP10-D32-W25-L150-Z04	●	32	4	25	150	35	10			
AEM90-AP10-D32-W32-L150-Z04	●	32	4	32	150	50	10			
AEM90-AP10-D40-W32-L150-Z05	●	40	5	32	150	40	10			
AEM90-AP10D-D16-W16-L150-Z02	●	16	2	16	150	50	10	AP.. 1003.. DJT UCUNA UYGUNDUR. FOR DJT INSERT		
AEM90-AP10D-D20-W20-L150-Z03	●	20	3	20	150	50	10			
AEM90-AP11-D16-C16-L150-Z02	●	16	2	16	150	50	11	AP.. 11T3.. ZCC UCUNA UYGUNDUR. FOR ZCC INSERT.	3008-M2.5x6	80-T08
AEM90-AP11-D16-C16-L150-Z02-H	●	16	2	16	150	50	11			
AEM90-AP11-D16-W16-L150-Z02	●	16	2	16	150	50	11			
AEM90-AP11-D16-C16-L200-Z02	●	16	2	16	200	100	11			
AEM90-AP11-D17-C16-L150-Z02	●	17	2	16	150	30	11			
AEM90-AP11-D17-C16-L200-Z02	●	17	2	16	200	30	11			
AEM90-AP11-D20-C20-L150-Z03	●	20	3	20	150	50	11			
AEM90-AP11-D20-W20-L150-Z03	●	20	3	20	150	50	11			
AEM90-AP11-D20-W20-L150-Z03-H	●	20	3	20	150	50	11			
AEM90-AP11-D20-C20-L200-Z03	●	20	3	20	200	100	11			
AEM90-AP11-D21-C20-L150-Z03	●	21	3	20	150	30	11			
AEM90-AP11-D21-W20-L150-Z03	●	21	3	20	150	30	11			
AEM90-AP11-D21-W20-L150-Z03-H	●	21	3	20	150	30	11			
AEM90-AP11-D21-C20-L200-Z03	●	21	3	20	200	30	11			
AEM90-AP11-D25-C25-L150-Z03	●	25	3	25	150	50	11			
AEM90-AP11-D25-W25-L150-Z03	●	25	3	25	150	50	11			
AEM90-AP11-D25-W25-L150-Z03-H	●	25	3	25	150	50	11			
AEM90-AP11-D26-C25-L150-Z03	●	26	3	25	150	35	11			
AEM90-AP11-D26-C24-L150-Z03	●	26	3	24	150	47	11			
AEM90-AP11-D32-W25-L150-Z04	●	32	4	25	150	35	11			
AEM90-AP11-D32-W32-L150-Z03-H	●	32	3	32	150	50	11			
AEM90-AP11-D32-W32-L150-Z04	●	32	4	32	150	50	11			

R: Sağ/Right L: Sol/Left ● Stokta/In Stock ○ Stokta Yok/Non Stock Item

Sipariş Örneği/Ordering Example : 1 ad./pcs. AEM90-AP10-D30-C25-L100-Z04-H
Kesme Hesabı : S 271 / Cutting Calculation : P 271

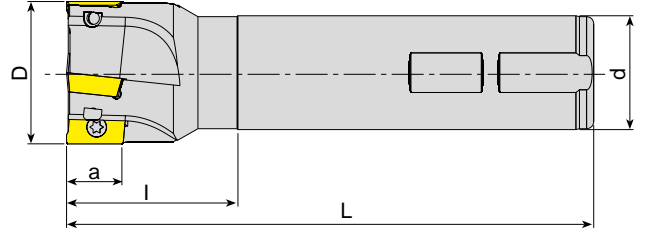

Takım Kodu Ordering Code	Stok Stock	Takım Ölçüleri (mm) Dimension (mm)						Kesici Uç Insert	Yedek Parçaları Spare Parts	
		D	Z	d	L	l	a		Sıkma Vidası Screw	Tork Anahtar Torx Key
AEM90-AP1135-D16-W16-L150-Z02	●	16	2	16	150	50	9.5	AP.. 1135.. GSC UCUNA UYGUNDUR. FOR GSC INSERT	3008-M2.5x6	80-T08
AEM90-AP1135-D20-W20-L150-Z03	●	20	3	20	150	50	9.5			
AEM90-AP1204-D20-C20-L150-Z02	●	20	2	20	150	30	12			
AEM90-AP1204-D21-C20-L150-Z02	●	21	2	20	150	30	12	AP.. 1204.. TGTC UCUNA UYGUNDUR. FOR TGTC INSERT.	1510-M3.5x7	80-T10
AEM90-AP1204-D21-C20-L200-Z02	●	21	2	20	200	30	12			
AEM90-AP1204-D25-C25-L150-Z03	●	25	3	25	150	40	12			
AEM90-AP1204-D26-C25-L250-Z02	●	26	2	25	250	35	12			
AEM90-AP1204-D32-C25-L150-Z03	●	32	3	25	150	35	12			
AEM90-AP16-D25-C20-L100-Z02	●	25	2	20	100	35	16			
AEM90-AP16-D25-W25-L100-Z02-H	●	25	2	25	100	35	16	AP.. 1604.. ISO UCUNA UYGUNDUR. FOR ISO INSERT.	4015-M4x9	80-T15
AEM90-AP16-D25-W25-L150-Z02	●	25	2	25	150	50	16			
AEM90-AP16-D25-C25-L250-Z02	●	25	2	25	250	100	16			
AEM90-AP16-D28-W25-L100-Z03-H	●	28	3	25	100	40	16			
AEM90-AP16-D28-W25-L150-Z03	●	28	3	25	150	40	16			
AEM90-AP16-D30-W25-L110-Z03-H	●	30	3	25	110	40	16			
AEM90-AP16-D30-W25-L150-Z02	●	30	2	25	150	40	16			
AEM90-AP16-D30-W25-L150-Z03	●	30	3	25	150	40	16			
AEM90-AP16-D32-W32-L110-Z03-H	●	32	3	32	110	40	16			
AEM90-AP16-D32-C32-L150-Z03	●	32	3	32	150	50	16			
AEM90-AP16-D32-W25-L150-Z03	●	32	3	25	150	40	16			
AEM90-AP16-D32-W32-L150-Z03	●	32	3	32	150	50	16			
AEM90-AP16-D32-W32-L150-Z03-H	●	32	3	32	150	50	16			
AEM90-AP16-D32-C25-L200-Z03-H	●	32	3	25	200	40	16			
AEM90-AP16-D32-C32-L250-Z02	●	32	2	32	250	100	16			
AEM90-AP16-D32-C32-L250-Z03	●	32	3	32	250	100	16			
AEM90-AP16-D35-W32-L150-Z03	●	35	3	32	150	40	16			
AEM90-AP16-D36-W32-L110-Z03-H	●	36	3	32	110	40	16			
AEM90-AP16-D36-W32-L150-Z03	●	36	3	32	150	40	16			
AEM90-AP16-D40-W32-L110-Z04-H	●	40	4	32	110	40	16			
AEM90-AP16-D40-C32-L150-Z04	●	40	4	32	150	40	16			
AEM90-AP16-D40-W32-L150-Z04	●	40	4	32	150	40	16			
AEM90-AP16-D40-C32-L250-Z02	●	40	2	32	250	40	16			
AEM90-AP16-D40-C32-L250-Z04	●	40	4	32	250	40	16			

R: Sağ/Right L: Sol/Left ● Stokta/In Stock ○ Stokta Yok/Non Stock Item

Sipariş Örneği/Ordering Example : 1 ad./pcs. AEM90-AP1135-D16-W16-L150-Z02

Kesme Hesabı : S 271 / Cutting Calculation : P 271

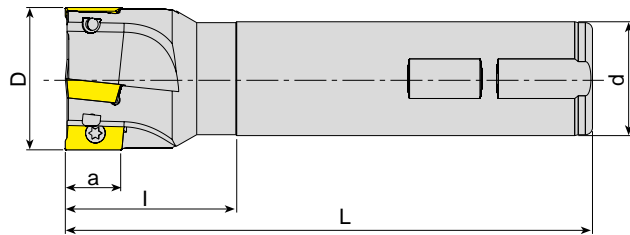

Takım Kodu Ordering Code	Stok Stock	Takım Ölçüleri (mm) Dimension (mm)						Kesici Uç Insert	Yedek Parçaları Spare Parts	
		D	Z	d	L	l	a		Sıkma Vidası Screw	Tork Anahtar Torx Key
AEM90-AP16DJ-D25-W25-L150-Z02	●	25	2	25	150	50	16	AP.. 1604.. DJT UCUNA UYGUNDUR. FOR DJT INSERT.		
AEM90-AP16DJ-D25-C25-L200-Z02	●	25	2	25	200	50	16			
AEM90-AP16DJ-D32-W32-L150-Z03	●	32	3	32	150	50	16			
AEM90-AP16DJ-D32-C32-L180-Z03	●	32	3	32	180	50	16	AP.. 1604.. LMN UCUNA UYGUNDUR. FOR LMN INSERT.	1515-M4x9	80-T15
AEM90-AP16DJ-D32-C32-L200-Z03	●	32	3	32	200	50	16			
AEM90-AP16L-D25-C25-L120-Z02-H	●	25	2	25	120	45	16			
AEM90-AP16L-D25-C25-L150-Z02	●	25	2	25	150	55	16	AP.. 1604.. LMN UCUNA UYGUNDUR. FOR LMN INSERT.	1515-M4x9	80-T15
AEM90-AP16L-D25-C25-L200-Z02	●	25	2	25	200	55	16			
AEM90-AP16L-D25-C25-L250-Z02	●	25	2	25	250	100	16			
AEM90-AP16L-D32-C32-L120-Z03-H	●	32	3	32	120	45	16	AP.. 1604.. PLBT UCUNA UYGUNDUR. FOR PLBT INSERT.	1515-M4x9	80-T15
AEM90-AP16L-D32-C32-L150-Z03	●	32	3	32	150	55	16			
AEM90-AP16L-D32-C32-L200-Z03	●	32	3	32	200	55	16			
AEM90-AP16L-D32-C32-L250-Z03	●	32	3	32	250	100	16	AP.. 1705.. TGTC-LMN UCUNA UYGUNDUR. FOR TGTC-LMN INSERT.	1515-M4x9	80-T15
AEM90-AP16L-D40-C32-L120-Z04-H	●	40	4	32	120	40	16			
AEM90-AP16L-D40-C32-L150-Z04	●	40	4	32	150	40	16			
AEM90-AP16L-D40-C32-L200-Z04	●	40	4	32	200	40	16	AP.. 1705.. TGTC-LMN UCUNA UYGUNDUR. FOR TGTC-LMN INSERT.	1515-M4x9	80-T15
AEM90-AP16L-D40-C32-L250-Z04	●	40	4	32	250	40	16			
AEM90-AP16P-D25-W25-L100-Z02-H	●	25	2	25	100	35	16			
AEM90-AP16P-D25-W25-L150-Z02	●	25	2	25	150	50	16	AP.. 1705.. TGTC-LMN UCUNA UYGUNDUR. FOR TGTC-LMN INSERT.	1515-M4x9	80-T15
AEM90-AP16P-D32-W32-L150-Z03	●	32	3	32	150	50	16			
AEM90-AP16P-D32-C32-L250-Z02	●	32	2	32	250	100	16			
AEM90-AP16P-D40-W32-L150-Z04	●	40	4	32	150	50	16	AP.. 1705.. TGTC-LMN UCUNA UYGUNDUR. FOR TGTC-LMN INSERT.	1515-M4x9	80-T15
AEM90-AP1705-D25-C25-L120-Z02	●	25	2	25	120	40	16			
AEM90-AP1705-D26-C25-L200-Z02	●	26	2	25	200	40	16			
AEM90-AP1705-D26-C25-L250-Z02	●	26	2	25	250	40	16	AP.. 1705.. TGTC-LMN UCUNA UYGUNDUR. FOR TGTC-LMN INSERT.	1515-M4x9	80-T15
AEM90-AP1705-D28-W25-L075-Z02	●	28	2	25	75	20	16			
AEM90-AP1705-D32-C25-L150-Z03	●	32	3	25	150	40	16			
AEM90-AP1705-D33-C32-L300-Z02	●	33	2	32	300	40	16	AP.. 1705.. TGTC-LMN UCUNA UYGUNDUR. FOR TGTC-LMN INSERT.	1515-M4x9	80-T15

R: Sağ/Right L: Sol/Left ● Stokta/In Stock ○ Stokta Yok/Non Stock Item

Sipariş Örneği/Ordering Example : 1 ad./pcs. AEM90-AP16DJ-D25-W25-L150-Z02
Kesme Hesabı : S 271 / Cutting Calculation : P 271

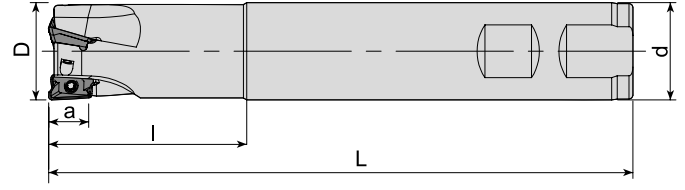

Takım Kodu Ordering Code	Stok Stock	Takım Ölçüleri (mm) Dimension (mm)						Kesici Uç Insert	Yedek Parçaları Spare Parts	
		D	Z	d	L	l	a		Sıkma Vidası Screw	Tork Anahtar Torx Key
AEM90-AO1236-D16-W16-L150-Z02	●	16	2	16	150	50	12			
AEM90-AO1236-D25-W25-L150-Z03	●	25	3	25	150	50	12			
AEM90-AO1236-D32-W32-L150-Z04	●	32	4	32	150	50	12			

MTSBH Ucuna Uygunudur. / Compatible with MTSBH Insert.

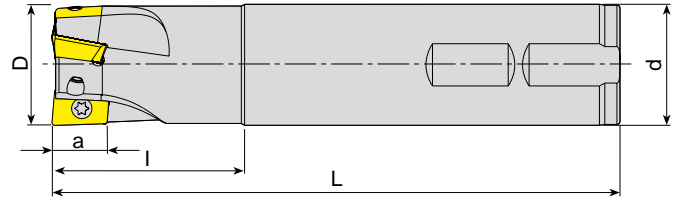

Takım Kodu Ordering Code	Stok Stock	Takım Ölçüleri (mm) Dimension (mm)						Kesici Uç Insert	Yedek Parçaları Spare Parts	
		D	Z	d	L	l	a		Sıkma Vidası Screw	Tork Anahtar Torx Key
AEM90-AX0602-D10-C10-L120-Z02	●	10	2	10	120	20	5.7			
AEM90-AX0602-D12-C12-L120-Z02	●	12	2	12	120	20	5.7			
AEM90-AX0602-D14-C12-L120-Z03	●	14	3	12	120	20	5.7			
AEM90-AX0602-D16-W16-L120-Z04-H	●	16	4	16	120	20	5.7			
AEM90-AX0602-D16-W16-L150-Z04-H	●	16	4	16	150	20	5.7			
AEM90-AX0602-D20-W20-L120-Z05-H	●	20	5	20	120	25	5.7			
AEM90-AX0602-D20-W20-L150-Z05-H	●	20	5	20	150	25	5.7			
AEM90-AX0903-D16-C16-L120-Z02	●	16	2	16	120	30	8.8			
AEM90-AX0903-D16-C16-L180-Z02	●	16	2	16	180	30	8.8			
AEM90-AX0903-D17-C16-L120-Z02	●	17	2	16	120	25	8.8			
AEM90-AX0903-D17-C16-L180-Z02	●	17	2	16	180	25	8.8			
AEM90-AX0903-D20-C20-L120-Z03	●	20	3	20	120	30	8.8			
AEM90-AX0903-D20-C20-L200-Z02	●	20	2	20	200	30	8.8			
AEM90-AX0903-D21-C20-L120-Z03	●	21	3	20	120	25	8.8			
AEM90-AX0903-D21-C20-L200-Z02	●	21	2	20	200	25	8.8			
AEM90-AX0903-D25-C25-L150-Z03	●	25	3	25	150	30	8.8			
AEM90-AX0903-D25-C25-L250-Z02	●	25	2	25	250	40	8.8			
AEM90-AX0903-D26-C25-L150-Z03	●	26	3	25	150	30	8.8			

R: Sağ/Right L: Sol/Left ● Stokta/In Stock ○ Stokta Yok/Non Stock Item
TGTC Ucuna Uygunudur. / Compatible with TGTC Insert.

Sipariş Örneği/Ordering Example : 1 ad./pcs. AEM90-AO1236-D16-W16-L150-Z02
Kesme Hesabı : S 271 / Cutting Calculation : P 271



www.akkо.com.tr

90°

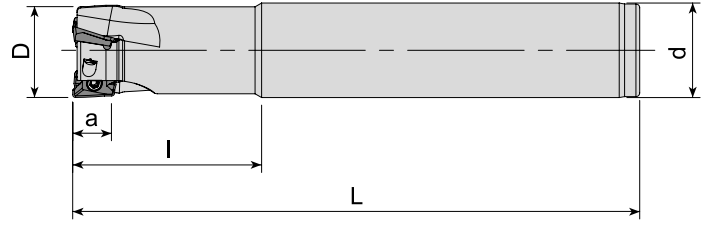

Takım Kodu Ordering Code	Stok Stock	Takım Ölçüleri (mm) Dimension (mm)						Kesici Uç Insert	Yedek Parçaları Spare Parts		
		D	Z	d	L	l	a		Sıkma Vidası Screw	Tork Anahtar Torx Key	
AEM90-AX1235-D16-C14-L120-Z02-H	●	16	2	14	120	25	10		1008-M3x6		
AEM90-AX1235-D16-C15-L145-Z02-H	●	16	2	15	145	30	10		3108-M3x6		
AEM90-AX1235-D16-C16-L100-Z02-H	●	16	2	16	100	30	10		1008-M3x6		
AEM90-AX1235-D16-C16-L140-Z02-H	●	16	2	16	140	30	10		3108-M3x6		
AEM90-AX1235-D16-C16-L145-Z02-H	●	16	2	16	145	30	10		1008-M3x6		
AEM90-AX1235-D16-C16-L150-Z02	●	16	2	16	150	30	10		3108-M3x6		
AEM90-AX1235-D20-C19-L150-Z02-H	●	20	2	19	150	40	10		1008-M3x6		
AEM90-AX1235-D20-C20-L110-Z03-H	●	20	3	20	110	40	10		3108-M3x6		
AEM90-AX1235-D20-C20-L150-Z02	●	20	2	20	150	40	10		1008-M3x6		
AEM90-AX1235-D20-C20-L150-Z02-H	●	20	2	20	150	40	10		3108-M3x6		
AEM90-AX1235-D20-C20-L150-Z03	●	20	3	20	150	40	10		1008-M3x6		
AEM90-AX1235-D25-C20-L120-Z04-H	●	25	4	20	120	30	10		3108-M3x6		
AEM90-AX1235-D25-C20-L150-Z04-H	●	25	4	20	150	30	10		1008-M3x6		
AEM90-AX1235-D25-C24-L170-Z02-H	●	25	2	24	170	50	10		3108-M3x6		
AEM90-AX1235-D25-C25-L120-Z04-H	●	25	4	25	120	40	10		1008-M3x6		
AEM90-AX1235-D25-C25-L150-Z03	●	25	3	25	150	50	10		3108-M3x6		
AEM90-AX1235-D25-C25-L170-Z02-H	●	25	2	25	170	50	10		1008-M3x6		
AEM90-AX1235-D25-W25-L100-Z04-H	●	25	4	25	100	30	10		3108-M3x6		
AEM90-AX1235-D32-C32-L130-Z05-H	●	32	5	32	130	40	10		4015-M4x9		80-T15
AEM90-AX1235-D32-C32-L180-Z02-H	●	32	2	32	180	50	10				
AEM90-AX1705-D25-C25-L150-Z02	●	25	2	25	150	50	14				
AEM90-AX1705-D28-W25-L115-Z02-H	●	28	2	25	115	35	14				
AEM90-AX1705-D32-C32-L150-Z03	●	32	3	32	150	50	14	4015-M4x9	80-T15		
AEM90-AX1705-D32-C32-L180-Z02-H	●	32	2	32	180	50	14				



R: Sağ/Right L: Sol/Left ● Stokta/In Stock ○ Stokta Yok/Non Stock Item
SMTM Ucuna Uygunudur. / Compatible with SMTM Insert.

Sipariş Örneği/Ordering Example : 1 ad./pcs. AEM90-AX1235-D16-C14-L120-Z02-H
Kesme Hesabı : S 271 / Cutting Calculation : P 271

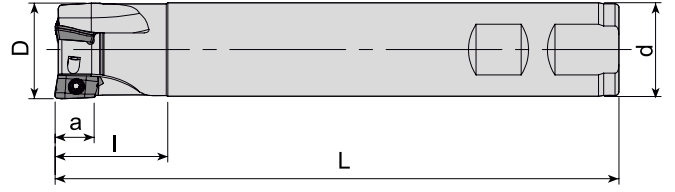

90°





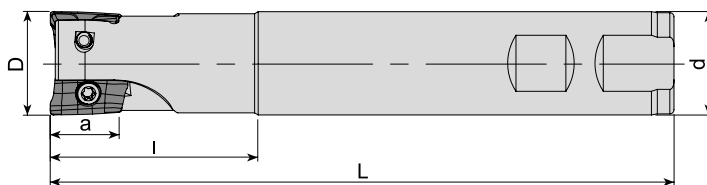

Takım Kodu Ordering Code	Stok Stock	Takım Ölçüleri (mm) Dimension (mm)						Kesici Uç Insert	Yedek Parçaları Spare Parts	
		D	Z	d	L	l	a		Sıkma Vidası Screw	Tork Anahtar Torx Key
AEM90-AZ11-D12-W16-L90-Z01	●	12	1	16	90	30	11			
AEM90-AZ11-D16-C16-L200-Z02	●	16	2	16	200	100	11			
AEM90-AZ11-D16-W15-L170-Z02	●	16	2	15	170	50	11			
AEM90-AZ11-D16-W16-L100-Z02	●	16	2	16	100	35	11			
AEM90-AZ11-D16-W16-L150-Z02	●	16	2	16	150	50	11			
AEM90-AZ11-D17-C16-L150-Z02	●	17	2	16	150	30	11			
AEM90-AZ11-D17-C16-L180-Z02	●	17	2	16	180	50	11			
AEM90-AZ11-D17-W16-L100-Z02	●	17	2	16	100	30	11			
AEM90-AZ11-D20-C20-L200-Z03	●	20	3	20	200	100	11			
AEM90-AZ11-D20-W19-L170-Z03	●	20	3	19	170	50	11			
AEM90-AZ11-D20-W20-L110-Z02	●	20	2	20	110	35	11			
AEM90-AZ11-D21-C20-L150-Z03	●	21	3	20	150	30	11			
AEM90-AZ11-D21-C20-L180-Z03	●	21	3	20	180	50	11			
AEM90-AZ11-D21-W20-L110-Z03	●	21	3	20	110	35	11			
AEM90-AZ11-D25-C24-L180-Z04	●	25	4	24	180	50	11			
AEM90-AZ11-D25-W25-L110-Z04	●	25	4	25	110	40	11			
AEM90-AZ11-D26-C25-L250-Z02	●	26	2	25	250	50	11			
AEM90-AZ11-D26-W25-L120-Z03	●	26	3	25	120	30	11			
AEM90-AZ11-D26-W25-L120-Z04	●	26	4	25	120	40	11			
AEM90-AZ11-D28-C25-L250-Z02	●	28	2	25	250	50	11			
AEM90-AZ11-D33-W32-L130-Z04	●	33	4	32	130	50	11			

R: Sağ/Right L: Sol/Left ● Stokta/In Stock ○ Stokta Yok/Non Stock Item
ZCC Ucuna Uygunudur. / Compatiple with ZCC Insert.

Sipariş Örneği/Ordering Example : 1 ad./pcs. AEM90-AZ11-D12-W16-L90-Z01
Kesme Hesabı : S 271 / Cutting Calculation : P 271

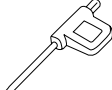

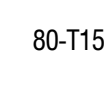
Takım Kodu Ordering Code	Stok Stock	Takım Ölçüleri (mm) Dimension (mm)						Kesici Uç Insert	Yedek Parçaları Spare Parts	
		D	Z	d	L	l	a		Sıkma Vidası Screw	Tork Anahtar Torx Key
AEM90-BD11T3-D16-W16-L100-Z02-H	●	16	2	16	100	30	10			
AEM90-BD11T3-D16-W16-L150-Z02	●	16	2	16	150	50	10			
AEM90-BD11T3-D17-W16-L150-Z02	●	17	2	16	150	50	10			
AEM90-BD11T3-D18-W16-L100-Z02-H	●	18	2	16	100	25	10			
AEM90-BD11T3-D20-W20-L100-Z03-H	●	20	3	20	100	30	10			
AEM90-BD11T3-D20-W20-L150-Z03	●	20	3	20	150	50	10			
AEM90-BD11T3-D21-W20-L150-Z03	●	21	3	20	150	50	10			
AEM90-BD11T3-D22-W20-L090-Z02-H	●	22	2	20	90	25	10			
AEM90-BD11T3-D25-W25-L100-Z03-H	●	25	3	25	100	30	10			
AEM90-BD11T3-D25-W25-L150-Z03	●	25	3	25	150	50	10			
AEM90-BD11T3-D26-W25-L150-Z03	●	26	3	25	150	50	10			
AEM90-BD11T3-D32-W32-L110-Z04-H	●	32	4	32	110	40	10			
AEM90-BD11T3-D32-W32-L150-Z04	●	32	4	32	150	50	10			
AEM90-BD11T3-D40-W32-L110-Z04-H	●	40	4	32	110	50	10			
AEM90-BD1704-D25-W25-L100-Z02-H	●	25	2	25	100	35	15.7			
AEM90-BD1704-D25-W25-L150-Z02	●	25	2	25	150	50	15.7			
AEM90-BD1704-D32-W32-L110-Z03-H	●	32	3	32	110	40	15.7			
AEM90-BD1704-D32-W32-L150-Z03	●	32	3	32	150	50	15.7			
AEM90-BD1704-D40-W32-L110-Z04-H	●	40	4	32	110	40	15.7			
AEM90-BD1704-D40-W32-L150-Z04	●	40	4	32	150	40	15.7			

R: Sağ/Right L: Sol/Left ● Stokta/In Stock ○ Stokta Yok/Non Stock Item
KYCR Ucuna Uygundur. / Compatible with KYCR Insert.

Sipariş Örneği/Ordering Example : 1 ad./pcs. AEM90-BD11T3-D16-W16-L100-Z02-H
Kesme Hesabı : S 271 / Cutting Calculation : P 271

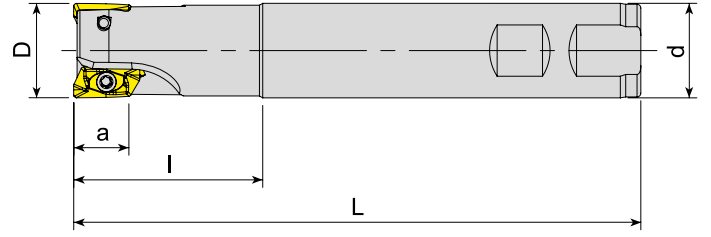

Takım Kodu Ordering Code	Stok Stock	Takım Ölçüleri (mm) Dimension (mm)						Kesici Uç Insert	Yedek Parçaları Spare Parts	
		D	Z	d	L	l	a		Sıkma Vidası Screw	Tork Anahtar Torx Key
AEM90-ED1404-D20-W20-L150-Z02	●	20	2	20	150	50	14.5			
AEM90-ED1404-D25-W25-L150-Z02	●	25	2	25	150	50	14.5			
AEM90-ED1404-D30-C25-L150-Z03	●	30	3	25	150	50	14.5			

KNMNTL Ucuna Uygunudur. / Compatiple with KNMNTL Insert.

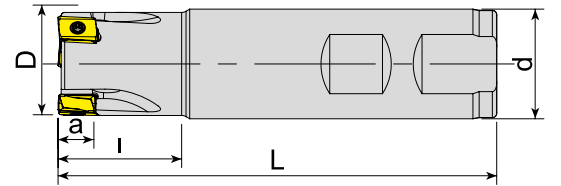

Takım Kodu Ordering Code	Stok Stock	Takım Ölçüleri (mm) Dimension (mm)						Kesici Uç Insert	Yedek Parçaları Spare Parts	
		D	Z	d	L	l	a		Sıkma Vidası Screw	Tork Anahtar Torx Key
AEM90-LN08-D16-W16-L100-Z02-H	●	16	2	16	100	28	8			
AEM90-LN08-D20-W20-L100-Z03-H	●	20	3	20	100	28	8			
AEM90-LN08-D25-W25-L100-Z03-H	●	25	3	25	100	30	8			
AEM90-LN08-D32-W32-L110-Z05-H	●	32	5	32	110	30	8			

R: Sağ/Right L: Sol/Left ● Stokta/In Stock ○ Stokta Yok/Non Stock Item
ISCR Ucuna Uygunudur. / Compatiple with ISCR Insert.

Sipariş Örneği/Ordering Example : 1 ad./pcs. AEM90-ED1404-D20-W20-L150-Z02
Kesme Hesabı : S 271 / Cutting Calculation : P 271

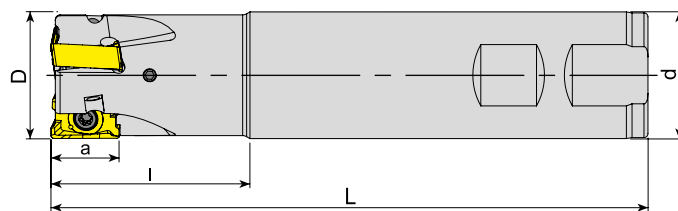

Takım Kodu Ordering Code	Stok Stock	Takım Ölçüleri (mm) Dimension (mm)						Kesici Uç Insert	Yedek Parçaları Spare Parts	
		D	Z	d	L	l	a		Sıkma Vidası Screw	Tork Anahtar Torx Key
AEM90-LN15T6-D25-W25-L150-Z02-H	●	25	2	25	150	50	15.5	LNGU 15T6..	4015-M4x12	80-T15
AEM90-LN15T6-D32-W32-L150-Z03-H	●	32	3	32	150	50	15.5			
AEM90-LN15T6-D40-W32-L150-Z03-H	●	40	3	32	150	40	15.5			

KNMTL Ucuna Uygundur. / Compatiple with KNMTL Insert.

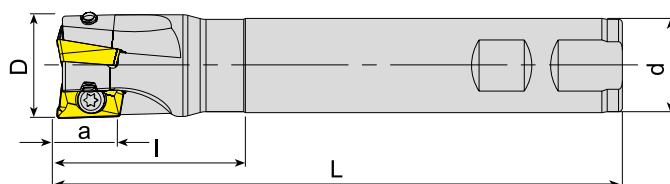

Takım Kodu Ordering Code	Stok Stock	Takım Ölçüleri (mm) Dimension (mm)						Kesici Uç Insert	Yedek Parçaları Spare Parts				
		D	Z	d	L	l	a		Sıkma Vidası Screw	Tork Anahtar Torx Key			
AEM90-R390.11-D16-W16-L100-Z02-H	●	16	2	16	100	30	10	R390-11T3..	3008-M2.5x6	80-T08			
AEM90-R390.11-D16-W16-L150-Z02	●	16	2	16	150	50	10						
AEM90-R390.11-D16-W16-L150-Z02-H	●	16	2	16	150	50	10						
AEM90-R390.11-D20-W20-L090-Z02-H	●	20	2	20	90	30	10						
AEM90-R390.11-D20-W20-L100-Z03-H	●	20	3	20	100	30	10						
AEM90-R390.11-D20-W20-L150-Z03	●	20	3	20	150	50	10						
AEM90-R390.11-D20-W20-L150-Z03-H	●	20	3	20	150	50	10						
AEM90-R390.11-D20-C20-L150-Z03	●	20	3	20	150	30	10						
AEM90-R390.11-D22-W20-L090-Z02-H	●	22	2	20	90	30	10						
AEM90-R390.11-D25-C20-L150-Z03	●	25	3	20	150	40	10						
AEM90-R390.11-D25-W25-L100-Z03-H	●	25	3	25	100	30	10						
AEM90-R390.11-D25-W25-L150-Z03	●	25	3	25	150	50	10						
AEM90-R390.11-D25-W25-L150-Z03-H	●	25	3	25	150	50	10						
AEM90-R390.11-D30-W25-L150-Z04-H	●	30	4	25	150	30	10						
AEM90-R390.11-D32-C25-L200-Z03	●	32	3	25	200	40	10						
AEM90-R390.11-D32-W32-L150-Z05-H	●	32	5	32	150	50	10						
AEM90-R390.17-D25-W25-L150-Z02	●	25	2	25	150	50	15.4				R390-1704..	4015-M3.5x8	80-T15
AEM90-R390.17-D25-W25-L150-Z02-H	●	25	2	25	150	50	15.4						
AEM90-R390.17-D30-W25-L150-Z03	●	30	3	25	150	40	15.4						
AEM90-R390.17-D30-W25-L150-Z03-H	●	30	3	25	150	40	15.4						
AEM90-R390.18-D32-C32-L150-Z03	●	32	3	32	150	45	15.4	R390-1806..	4015-M4x11				

R: Sağ/Right L: Sol/Left ● Stokta/In Stock ○ Stokta Yok/Non Stock Item
SNDVK Ucuna Uygundur. / Compatiple with SNDVK Insert.

Sipariş Örneği/Ordering Example : 1 ad./pcs. AEM90-LN15T6-D25-W25-L150-Z02-H
Kesme Hesabı : S 271 / Cutting Calculation : P 271

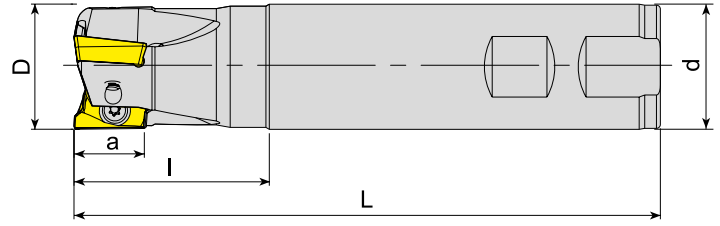

Takım Kodu Ordering Code	Stok Stock	Takım Ölçüleri (mm) Dimension (mm)						Kesici Uç Insert	Yedek Parçaları Spare Parts	
		D	Z	d	L	l	a		Sıkma Vidası Screw	Tork Anahtar Torx Key
AEM90-RT07-D10-W10-L120-Z02	●	10	2	10	120	30	7	RT 0702	3006-M2x4	80-T06
AEM90-RT07-D12-C12-L120-Z02	●	12	2	12	120	30	7			
AEM90-RT07-D12-W12-L120-Z02	●	12	2	12	120	30	7			
AEM90-RT07-D14-W12-L120-Z02	●	14	2	12	120	30	7			
AEM90-RT10-D16-C15-L160-Z02	●	16	2	15	160	30	10	RT 1003	3008-M2.5x6	80-T08
AEM90-RT10-D16-W16-L120-Z02-H	●	16	2	16	120	30	10			
AEM90-RT10-D16-W16-L150-Z02	●	16	2	16	150	50	10			
AEM90-RT10-D16-C16-L200-Z02	●	16	2	16	200	100	10			
AEM90-RT10-D17-W16-L160-Z02	●	17	2	16	160	30	10			
AEM90-RT10-D17-C16-L200-Z02	●	17	2	16	200	30	10			
AEM90-RT10-D18-W16-L120-Z02-H	●	18	2	16	120	30	10			
AEM90-RT10-D20-C19-L200-Z03	●	20	3	19	200	30	10			
AEM90-RT10-D20-W20-L120-Z03-H	●	20	3	20	120	30	10			
AEM90-RT10-D20-W20-L150-Z03	●	20	3	20	150	50	10			
AEM90-RT10-D20-C20-L200-Z03	●	20	3	20	200	100	10			
AEM90-RT10-D21-W20-L200-Z03	●	21	3	20	200	30	10			
AEM90-RT10-D22-W20-L120-Z03-H	●	22	3	20	120	30	10			
AEM90-RT10-D22-C20-L150-Z03	●	22	3	20	150	30	10			
AEM90-RT10-D22-C20-L200-Z03	●	22	3	20	200	30	10			
AEM90-RT10-D25-W25-L120-Z04-H	●	25	4	25	120	40	10			
AEM90-RT10-D25-W25-L150-Z04	●	25	4	25	150	50	10			
AEM90-RT10-D25-C25-L200-Z04	●	25	4	25	200	100	10			
AEM90-RT10-D26-C25-L250-Z04	●	26	4	25	250	32	10			
AEM90-RT10-D32-W32-L120-Z05-H	●	32	5	32	120	50	10			
AEM90-RT10-D32-W32-L150-Z05	●	32	5	32	150	50	10			
AEM90-RT10-D32-C32-L200-Z05	●	32	5	32	200	100	10			
AEM90-RT10-D33-C32-L250-Z04	●	33	4	32	250	32	10			
AEM90-RT13-D32-C32-L250-Z04	●	32	4	32	250	50	13	RT 1304	1008-M3x8	
AEM90-RT16-D25-W25-L120-Z02-H	●	25	2	25	120	40	16	RT 1606	4015-M4x9	80-T15
AEM90-RT16-D25-W25-L150-Z02	●	25	2	25	150	50	16			
AEM90-RT16-D25-C25-L200-Z02	●	25	2	25	200	100	16			
AEM90-RT16-D32-W32-L120-Z03-H	●	32	3	32	120	50	16			
AEM90-RT16-D32-W32-L150-Z03	●	32	3	32	150	50	16			
AEM90-RT16-D32-C32-L200-Z03	●	32	3	32	200	100	16			
AEM90-RT16-D32-C32-L250-Z03	●	32	3	32	250	100	16			
AEM90-RT16-D32-C32-L270-Z03	●	32	3	32	270	100	16			
AEM90-RT16-D40-W32-L120-Z04-H	●	40	4	32	120	50	16			
AEM90-RT16-D40-W32-L150-Z04	●	40	4	32	150	50	16			
AEM90-RT16-D40-C32-L200-Z04	●	40	4	32	200	100	16			

R: Sağ/Right L: Sol/Left ● Stokta/In Stock ○ Stokta Yok/Non Stock Item
SFTY Ucuna Uygunudur. / Compatible with SFTY Insert.

Sipariş Örneği/Ordering Example : 1 ad./pcs. AEM90-RT07-D10-W10-L120-Z02
Kesme Hesabı : S 271 / Cutting Calculation : P 271

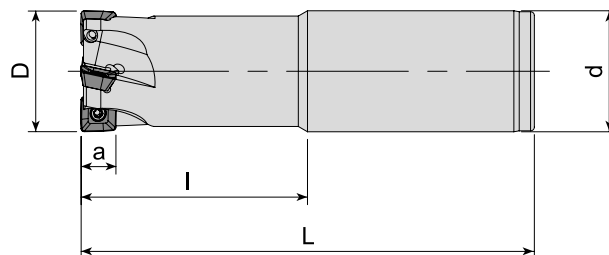

Takım Kodu Ordering Code	Stok Stock	Takım Ölçüleri (mm) Dimension (mm)						Kesici Uç Insert	Yedek Parçaları Spare Parts	
		D	Z	d	L	l	a		Sıkma Vidası Screw	Tork Anahtar Torx Key
AEM90-SE09-D25-C25-L120-Z03-H	●	25	3	25	120	60	6.7	SEET 09T3..	1008-M3x8	80-T08
AEM90-SE09-D25-C25-L150-Z02	●	25	2	25	150	50	6.7			
AEM90-SE09-D32-C32-L120-Z04-H	●	32	4	32	120	60	6.7			
AEM90-SE09-D32-C32-L150-Z03	●	32	3	32	150	50	6.7			

ZCC Ucuna Uygundur. / Compatible with ZCC Insert.

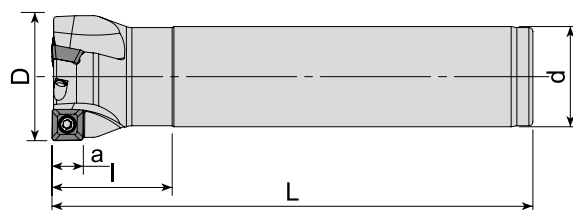

Takım Kodu Ordering Code	Stok Stock	Takım Ölçüleri (mm) Dimension (mm)						Kesici Uç Insert	Yedek Parçaları Spare Parts	
		D	Z	d	L	l	a		Sıkma Vidası Screw	Tork Anahtar Torx Key
AEM90-S00803-D20-C16-L110-Z02-H	●	20	2	16	110	25	7	SOMT 0803..	3008-M3x7	80-T08
AEM90-S00803-D25-C20-L110-Z02-H	●	25	2	20	110	25	7			
AEM90-S00803-D32-C25-L120-Z03-H	●	32	3	25	120	30	7			

R: Sağ/Right L: Sol/Left ● Stokta/In Stock ○ Stokta Yok/Non Stock Item
SMTM Ucuna Uygundur. / Compatible with SMTM Insert.

Sipariş Örneği/Ordering Example : 1 ad./pcs. AEM90-SE09-D25-C25-L120-Z03-H
Kesme Hesabı : S 271 / Cutting Calculation : P 271

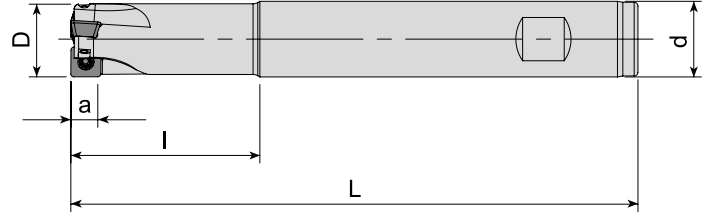

Takım Kodu Ordering Code	Stok Stock	Takım Ölçüleri (mm) Dimension (mm)						Yedek Parçaları Spare Parts		
		D	Z	d	L	l	a	Kesici Uç Insert	Sıkma Vidası Screw	Tork Anahtar Torx Key
AEM90-SPGT0602-D16-W16-L150-Z02	●	16	2	16	150	50	5.5		3007-M2.2x5	80-T07
AEM90-SPGT07T3-D20-W20-L150-Z03	●	20	3	20	150	50	7		3008-M2.5x6	80-T08
AEM90-SPGT07T3-D25-W25-L150-Z03	●	25	3	25	150	50	7		3008-M2.5x6	80-T08
AEM90-SPGT0904-D30-W32-L150-Z03	●	30	3	32	150	50	9		4015-M3.5x9	80-T15

ZCC Ucuna Uygunudur. / Compatible with ZCC Insert.

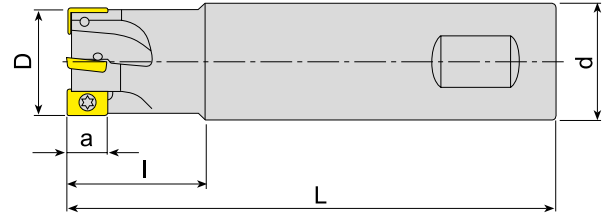



Takım Kodu Ordering Code	Stok Stock	Takım Ölçüleri (mm) Dimension (mm)						Yedek Parçaları Spare Parts		
		D	Z	d	L	l	a	Kesici Uç Insert	Sıkma Vidası Screw	Tork Anahtar Torx Key
AEM90-XC13-D20-W20-L150-Z02	●	20	2	20	150	60	13		1008-M3x6	80-T08
AEM90-XC13-D25-W25-L150-Z03	●	25	3	25	150	60	13		1008-M3x8	80-T08
AEM90-XC13-D32-W32-L150-Z04	●	32	4	32	150	60	13		1008-M3x8	80-T08

R: Sağ/Right L: Sol/Left ● Stokta/In Stock ○ Stokta Yok/Non Stock Item
SC Ucuna Uygunudur. / Compatible with SC Insert.

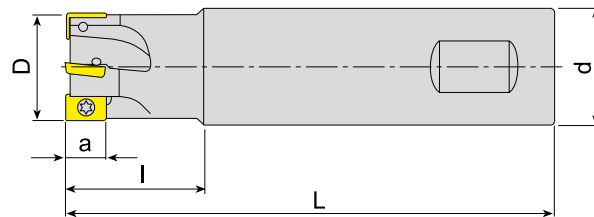



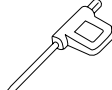

Sipariş Örneği/Ordering Example : 1 ad./pcs. AEM90-SPGT0602-D16-W16-L150-Z02
Kesme Hesabı : S 271 / Cutting Calculation : P 271

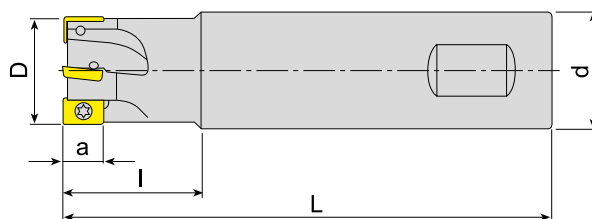

Takım Kodu Ordering Code	Stok Stock	Takım Ölçüleri (mm) Dimension (mm)						Kesici Uç Insert	Yedek Parçaları Spare Parts	
		D	Z	d	L	l	a		Sıkma Vidası Screw	Tork Anahtar Torx Key
AEM90-XD11T3-D16-W16-L150-Z02	●	16	2	16	150	30	10			
AEM90-XD11T3-D17-C16-L150-Z02	●	17	2	16	150	30	10			
AEM90-XD11T3-D20-W20-L150-Z03	●	20	3	20	150	50	10			
AEM90-XD11T3-D21-C20-L150-Z03	●	21	3	20	150	30	10			
AEM90-XD11T3-D25-W25-L150-Z04	●	25	4	25	150	50	10			
AEM90-XD11T3-D32-W32-L150-Z04	●	32	4	32	150	50	10			

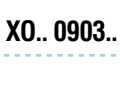
CRTZT Ucuna Uygun. / Compatiple with CRTZT Insert.

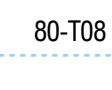
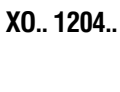

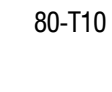

Takım Kodu Ordering Code	Stok Stock	Takım Ölçüleri (mm) Dimension (mm)						Kesici Uç Insert	Yedek Parçaları Spare Parts	
		D	Z	d	L	l	a		Sıkma Vidası Screw	Tork Anahtar Torx Key
AEM90-X006-D10-C12-L120-Z02	●	10	2	12	120	50	5			
AEM90-X006-D12-C12-L120-Z02	●	12	2	12	120	25	5			
AEM90-X009-D16-W16-L150-Z02	●	16	2	16	150	50	8			
AEM90-X009-D20-W20-L150-Z03	●	20	3	20	150	50	8			
AEM90-X012-D20-W20-L150-Z02	●	20	2	20	150	50	11			
AEM90-X012-D20-C20-L200-Z02	●	20	2	20	200	100	11			
AEM90-X012-D22-W20-L150-Z02	●	22	2	20	150	30	11			
AEM90-X012-D25-W25-L150-Z03	●	25	3	25	150	50	11			
AEM90-X012-D25-C25-L200-Z03	●	25	3	25	200	100	11			
AEM90-X012-D32-C25-L150-Z04	●	32	4	25	150	40	11			
AEM90-X012-D32-W32-L150-Z04	●	32	4	32	150	50	11			
AEM90-X012-D32-C32-L250-Z04	●	32	4	32	250	100	11			

R: Sağ/Right L: Sol/Left ● Stokta/In Stock ○ Stokta Yok/Non Stock Item
SC Ucuna Uygun. / Compatiple with SC Insert.

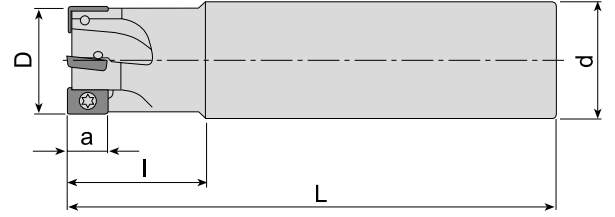

Sipariş Örneği/Ordering Example : 1 ad./pcs. AEM90-XD11T3-D16-W16-L150-Z02
Kesme Hesabı : S 271 / Cutting Calculation : P 271

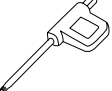

Takım Kodu Ordering Code	Stok Stock	Takım Ölçüleri (mm) Dimension (mm)						Kesici Uç Insert	Yedek Parçaları Spare Parts	
		D	Z	d	L	l	a		Sıkma Vidası Screw	Tork Anahtar Torx Key
AEM90-ZC1003-D16-C14-L150-Z02	●	16	2	14	150	25	9			
AEM90-ZC1003-D16-C14-L200-Z02	●	16	2	14	200	25	9			
AEM90-ZC1003-D16-C15-L150-Z02	●	16	2	15	150	25	9			
AEM90-ZC1003-D16-C16-L150-Z02	●	16	2	16	150	25	9			
AEM90-ZC1003-D17-C16-L150-Z02	●	17	2	16	150	25	9			
AEM90-ZC1003-D17-C16-L200-Z02	●	17	2	16	200	25	9			
AEM90-ZC1003-D20-C18-L150-Z03	●	20	3	18	150	25	9			
AEM90-ZC1003-D20-C18-L200-Z02	●	20	2	18	200	25	9			
AEM90-ZC1003-D20-C20-L150-Z03	●	20	3	20	150	40	9			
AEM90-ZC1003-D20-C18-L200-Z03	●	20	3	18	200	25	9			
AEM90-ZC1003-D21-C20-L150-Z03	●	21	3	20	150	30	9			
AEM90-ZC1003-D21-C20-L200-Z03	●	21	3	20	200	30	9			
AEM90-ZC1003-D25-C20-L150-Z03	●	25	3	20	150	30	9			
AEM90-ZC1003-D25-C20-L200-Z03	●	25	3	20	200	30	9			
AEM90-ZC1003-D25-C25-L150-Z03	●	25	3	25	150	40	9			
AEM90-ZC1003-D26-C25-L170-Z03	●	26	3	25	170	25	9			
AEM90-ZC1003-D26-C25-L200-Z03	●	26	3	25	200	25	9			
AEM90-ZC1003-D32-C25-L180-Z04	●	32	4	25	180	30	9			
AEM90-ZC1003-D33-C32-L200-Z04	●	33	4	32	200	25	9			

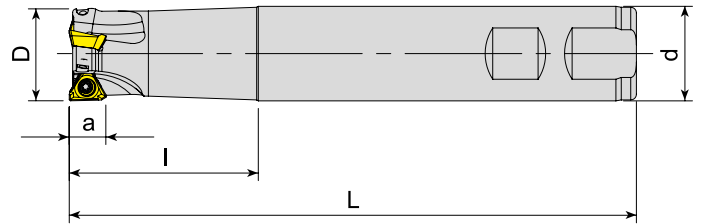
DJT Ucuna Uygundur. / Compatible with DJT Insert.

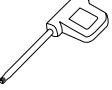

Takım Kodu Ordering Code	Stok Stock	Takım Ölçüleri (mm) Dimension (mm)						Kesici Uç Insert	Yedek Parçaları Spare Parts	
		D	Z	d	L	l	a		Sıkma Vidası Screw	Tork Anahtar Torx Key
AEM90-3P1004-D20-W20-L150-Z02	●	20	2	20	150	40	7			
AEM90-3P1004-D25-W25-L150-Z03	●	25	3	25	150	40	7			
AEM90-3P1505-D32-W32-L150-Z03	●	32	3	32	150	50	11			
AEM90-3P1505-D40-W32-L150-Z04	●	40	4	32	150	35	11			

R: Sağ/Right L: Sol/Left ● Stokta/In Stock ○ Stokta Yok/Non Stock Item
TGTC Ucuna Uygundur. / Compatible with TGTC Insert.

Sipariş Örneği/Ordering Example : 1 ad./pcs. AEM90-ZC1003-D16-C14-L150-Z02
Kesme Hesabı : S 271 / Cutting Calculation : P 271

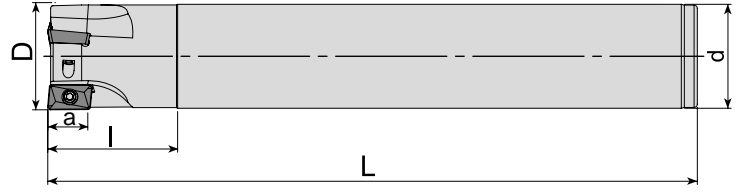

Takım Kodu Ordering Code	Stok Stock	Takım Ölçüleri (mm) Dimension (mm)						Kesici Uç Insert	Yedek Parçaları Spare Parts	
		D	Z	d	L	l	a		Sıkma Vidası Screw	Tork Anahtar Torx Key
AEM90-ZP13T3-D26-C25-L200-Z02	●	26	2	25	200	35	13	ZPMT 13T3..	4010-M3x8	80-T10
AEM90-ZP13T3-D26-C25-L200-Z03	●	26	3	25	200	35	13			
AEM90-ZP13T3-D26-C25-L250-Z02	●	26	2	25	250	35	13			
AEM90-ZP13T3-D33-C32-L200-Z03	●	33	3	32	200	40	13			
AEM90-ZP13T3-D33-C32-L250-Z03	●	33	3	32	250	40	13			

DJT Ucuna Uygundur. / Compatiple with DJT Insert.

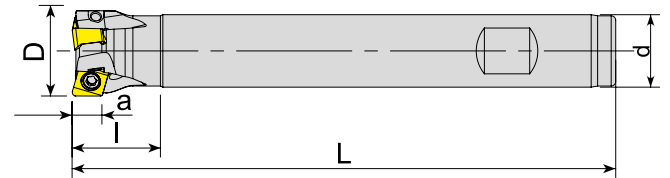

Takım Kodu Ordering Code	Stok Stock	Takım Ölçüleri (mm) Dimension (mm)						Kesici Uç Insert	Yedek Parçaları Spare Parts	
		D	Z	d	L	l	a		Sıkma Vidası Screw	Tork Anahtar Torx Key
AEM90-4N06-D16-W16-L120-Z02-H	●	16	2	16	120	25	6	4NKT 0603..	1108-M3x6.8	80-T08
AEM90-4N06-D16-W16-L160-Z02	●	16	2	16	160	25	6			
AEM90-4N06-D20-W16-L120-Z03-H	●	20	3	16	120	20	6			
AEM90-4N06-D20-W16-L160-Z03	●	20	3	16	160	20	6			

R: Sağ/Right L: Sol/Left ● Stokta/In Stock ○ Stokta Yok/Non Stock Item
TGTC Ucuna Uygundur. / Compatiple with TGTC Insert.

Sipariş Örneği/Ordering Example : 1 ad./pcs. AEM90-ZP13T3-D26-C25-L200-Z02
Kesme Hesabı : S 271 / Cutting Calculation : P 271

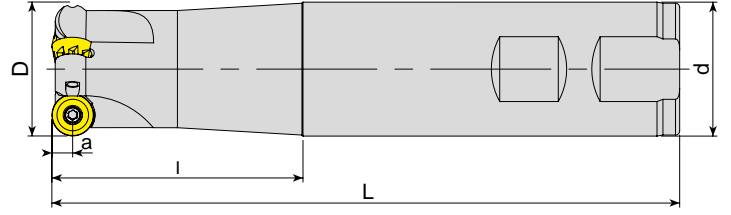

Takım Kodu Ordering Code	Stok Stock	Takım Ölçüleri (mm) Dimension (mm)						Kesici Uç Insert	Yedek Parçaları Spare Parts			
		D	Z	d	L	l	a		Sıkma Vidası Screw	Baskı Parçası Wedge Clamp	Baskı Vidası Clamp Screw	Tork Anahtar Torx Key
AEMR-RP10T3-D25-W25-L150-Z02	●	25	2	25	150	60	5	RPNX 10T3..	4010-M3x8	-	-	80-T10
AEMR-RP10T3-D32-W32-L150-Z03	●	32	3	32	150	60	5					

CRTZT Ucuna Uygundur. / Compatible with CRTZT Insert.

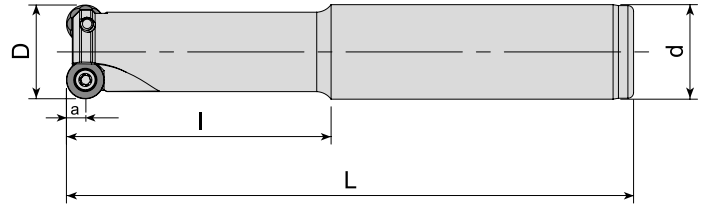

Takım Kodu Ordering Code	Stok Stock	Takım Ölçüleri (mm) Dimension (mm)						Kesici Uç Insert	Yedek Parçaları Spare Parts			
		D	Z	d	L	l	a		Sıkma Vidası Screw	Baskı Parçası Wedge Clamp	Baskı Vidası Clamp Screw	Tork Anahtar Torx Key
AEMR-QP10T3-D20-C20-L150-Z01-H	●	20	1	20	150	70	5	QP.. 10T3..	4015-M3.5x9	-	-	80-T15
AEMR-QP10T3-D25-C25-L120-Z02-H	●	25	2	25	120	40	5					
AEMR-QP10T3-D25-C25-L150-Z02-H	●	25	2	25	150	70	5					
AEMR-QP10T3-D25-C25-L170-Z02	●	25	2	25	170	90	5					
AEMR-QP10T3-D32-C32-L150-Z03-H	●	32	3	32	150	70	5					
AEMR-QP10T3-D32-C32-L170-Z03	●	32	3	32	170	90	5					
AEMR-QP1204-D25-C25-L150-Z02-H	●	25	2	25	150	70	6	QP.. 1204..	1515-M4x9	-	-	

R: Sağ/Right L: Sol/Left ● Stokta/In Stock ○ Stokta Yok/Non Stock Item
SMTM Ucuna Uygundur. / Compatible with SMTM Insert.

Sipariş Örneği/Ordering Example : 1 ad./pcs. AEMR-RP10T3-D25-W25-L150-Z02
Kesme Hesabı : S 271 / Cutting Calculation : P 271

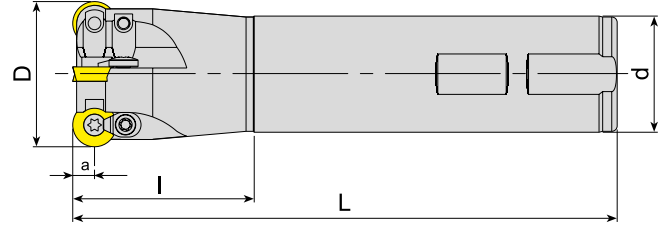

Takım Kodu Ordering Code	Stok Stock	Takım Ölçüleri (mm) Dimension (mm)					Kesici Uç Insert	Yedek Parçaları Spare Parts									
		D	Z	d	L	l		a	Sıkma Vidası Screw	Baskı Parçası Wedge Clamp	Baskı Vidası Clamp Screw	Tork Anahtar Torx Key					
AEMR-RD0501-D08-W10-L100-Z01-H	●	8	1	10	100	20	2.5	RD.. 0501	3006-M2x3.6			80-T06					
AEMR-RD0501-D10-W12-L100-Z02-H	●	10	2	12	100	20	2.5						3006-M2x4				
AEMR-RD0501-D12-W12-L120-Z02-H	●	12	2	12	120	20	2.5										
AEMR-RD0803-D16-W16-L150-Z02	●	16	2	16	150	60	4	RD.. 0803	1008-M3x6	-	-	80-T08					
AEMR-RD0803-D16-C20-L200-Z02	●	16	2	20	200	60	4										
AEMR-RD08T2-D16-W16-L150-Z02	●	16	2	16	150	60	4	RD.. 08T2	3008-M2.5x6								
AEMR-RD08T2-D20-W20-L150-Z02	●	20	2	20	150	60	4										
AEMRC-RD1003-D20-W20-L150-Z02	●	20	2	20	150	60	5	RD.. 1003									
AEMRC-RD1003-D20-C20-L160-Z02	●	20	2	20	160	70	5										
AEMRC-RD1003-D20-C20-L250-Z02	●	20	2	20	250	150	5										
AEMRC-RD1003-D21-C20-L160-Z02	●	21	2	20	160	70	5										
AEMRC-RD1003-D25-W25-L150-Z02	●	25	2	25	150	60	5										
AEMRC-RD1003-D25-C25-L160-Z02	●	25	2	25	160	70	5										
AEMRC-RD1003-D25-W25-L200-Z02	●	25	2	25	200	100	5										
AEMRC-RD1003-D25-C25-L200-Z02	●	25	2	25	200	100	5										
AEMRC-RD1003-D25-C25-L250-Z02	●	25	2	25	250	150	5										
AEMRC-RD1003-D26-C25-L160-Z02	●	26	2	25	160	70	5										
AEMRC-RD1003-D32-W32-L150-Z03	●	32	3	32	150	60	5										
AEMRC-RD1003-D32-C32-L250-Z02	●	32	2	32	250	150	5										
AEMRC-RD1003-D33-C32-L160-Z03	●	33	3	32	160	70	5										
AEMRC-RD1003-D40-W32-L150-Z04	●	40	4	32	150	35	5										
AEMRC-RD1003-D40-C32-L250-Z02	●	40	2	32	250	35	5						4015-M3.5x9	ACK-15	1015-M3.5x11	80-T15	
AEMRC-RD10T3-D20-W20-L150-Z02	●	20	2	20	150	60	5						RD.. 10T3				
AEMRC-RD10T3-D25-W25-L150-Z02	●	25	2	25	150	60	5										
AEMRC-RD10T3-D32-W32-L150-Z03	●	32	3	32	150	60	5										
AEMRC-RD1204-D32-C32-L160-Z03	●	32	3	32	160	70	6						RD.. 1204				
AEMRC-RD1204-D32-W32-L160-Z03	●	32	3	32	160	50	6										
AEMRC-RD1204-D33-C32-L160-Z03	●	33	3	32	160	70	6	RD.. 12T3									
AEMRC-RD12T3-D25-W25-L150-Z02	●	25	2	25	150	60	6										
AEMRC-RD12T3-D25-W25-L200-Z02	●	25	2	25	200	100	6										
AEMRC-RD12T3-D25-C25-L250-Z02	●	25	2	25	250	150	6										
AEMRC-RD12T3-D32-W32-L150-Z03	●	32	3	32	150	60	6										
AEMRC-RD12T3-D32-C32-L250-Z02	●	32	2	32	250	150	6										
AEMRC-RD12T3-D40-W32-L150-Z04	●	40	4	32	150	50	6										
AEMRC-RD12T3-D40-C32-L250-Z02	●	40	2	32	250	50	6										
AEMRC-RD1604-D40-W32-L150-Z02	●	40	2	32	150	35	8	RD.. 1604	1515-M4.5x11	ACK-05	1515-M4x11						

R: Sağ/Right L: Sol/Left ● Stokta/In Stock ○ Stokta Yok/Non Stock Item
ISO Ucuna Uygunudur. / Compatible with ISO Insert.

Sipariş Örneği/Ordering Example : 1 ad./pcs. AEMR-RD0501-D08-W10-L100-Z01-H
Kesme Hesabı : S 271 / Cutting Calculation : P 271

➤ **S-SİSTEM YÜZEY ve KOPYA PARMAK FREZELER**
S-SYSTEM FACE and COPY END MILLS

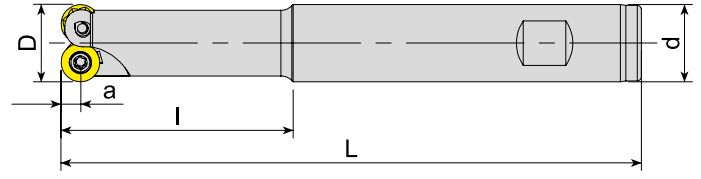

Takım Kodu Ordering Code	Stok Stock	Takım Ölçüleri (mm) Dimension (mm)						Kesici Uç Insert	Yedek Parçaları Spare Parts	
		D	Z	d	L	l	a		Sıkma Vidası Screw	Tork Anahtar Torx Key
AEMR-RY08-D16-W16-L150-Z02	●	16	2	16	150	55	4		4010-M3x6	80-T10
AEMR-RY10-D20-W20-L150-Z02	●	20	2	20	150	60	5		4015-M3.5x8	80-T15
AEMR-RY10-D20-C20-L200-Z02	●	20	2	20	200	100	5			
AEMR-RY10-D25-W25-L150-Z02	●	25	2	25	150	60	5			

TGTC Ucuna Uygundur. / Compatiple with TGTC Insert.

➤ **S-SİSTEM HIZLI İLERLEMELİ PARMAK FREZELER**
S-SYSTEM HIGHFEED END MILLS

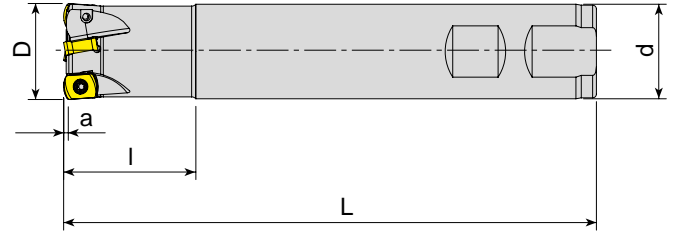

Takım Kodu Ordering Code	Stok Stock	Takım Ölçüleri (mm) Dimension (mm)						Kesici Uç Insert	Yedek Parçaları Spare Parts	
		D	Z	d	L	l	a		Sıkma Vidası Screw	Tork Anahtar Torx Key
AHFM-BL0603-D17-W16-L170-Z02	●	17	2	16	170	20	1		3008-M2.5x6	80-T08
AHFM-BL0603-D18-W16-L150-Z02-H	●	18	2	16	150	20	1			
AHFM-BL0603-D21-W20-L200-Z03	●	21	3	20	200	25	1			
AHFM-BL0603-D26-W25-L200-Z04	●	26	4	25	200	35	1			

R: Sağ/Right L: Sol/Left ● Stokta/In Stock ○ Stokta Yok/Non Stock Item
TGTC Ucuna Uygundur. / Compatiple with TGTC Insert.

S parış Örneği/Ordering Example : 1 ad./pcs. AEMR-RY08-D16-W16-L150-Z02
Kesme Hesabı : S 271 / Cutting Calculation : P 271

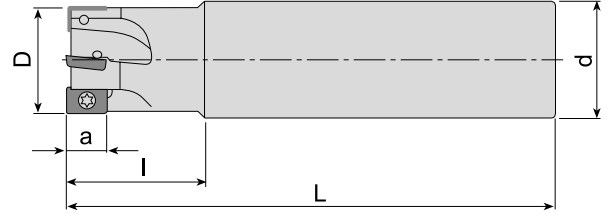

Takım Kodu Ordering Code	Stok Stock	Takım Ölçüleri (mm) Dimension (mm)						Kesici Uç Insert	Yedek Parçaları Spare Parts	
		D	Z	d	L	l	a		Sıkma Vidası Screw	Tork Anahtar Torx Key
AHFM-E00602-D10-C10-L080-Z02	●	10	2	10	80	20	-	 EO.. 0602.. ZOMT 0602..	 3006-M1.8x4	 80-T06
AHFM-E00602-D10-C09-L120-Z02	●	10	2	9	120	15	-			
AHFM-E00602-D10-C10-L120-Z02	●	10	2	10	120	60	-			
AHFM-E00602-D12-C12-L080-Z02	●	12	2	12	80	20	-			
AHFM-E00602-D12-C12-L080-Z03	●	12	3	12	80	20	-			
AHFM-E00602-D12-C11-L120-Z02	●	12	2	11	120	15	-			
AHFM-E00602-D12-C11-L120-Z03	●	12	3	11	120	15	-			
AHFM-E00602-D12-C12-L120-Z02	●	12	2	12	120	60	-			
AHFM-E00602-D12-C12-L120-Z03	●	12	3	12	120	60	-			
AHFM-E00602-D16-C16-L150-Z04	●	16	4	16	150	60	-			

DJT Ucuna Uygundur. / Compatiple with DJT Insert.

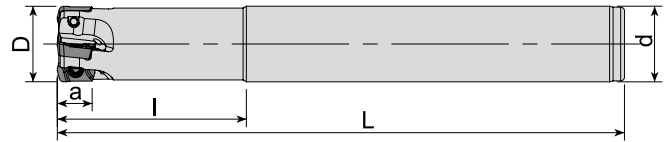

Takım Kodu Ordering Code	Stok Stock	Takım Ölçüleri (mm) Dimension (mm)						Kesici Uç Insert	Yedek Parçaları Spare Parts	
		D	Z	d	L	l	a		Sıkma Vidası Screw	Tork Anahtar Torx Key
AHFM-EP1003-D16-C16-L150-Z02-H	●	16	2	16	150	50	1	 EP.. 1003.. ZPMT 1003.. YPHW 1003..	 3008-M2.5x5.5	 80-T08
AHFM-EP1003-D17-C16-L150-Z02-H	●	17	2	16	150	20	1			
AHFM-EP1003-D20-C20-L150-Z04-H	●	20	4	20	150	50	1			
AHFM-EP1003-D21-C20-L150-Z04-H	●	21	4	20	150	20	1			

R: Sağ/Right L: Sol/Left ● Stokta/In Stock ○ Stokta Yok/Non Stock Item
DJT Ucuna Uygundur. / Compatiple with DJT Insert.

Sipariş Örneği/Ordering Example : 1 ad./pcs. AHFM-E00602-D10-C10-L080-Z02
Kesme Hesabı : S 271 / Cutting Calculation : P 271

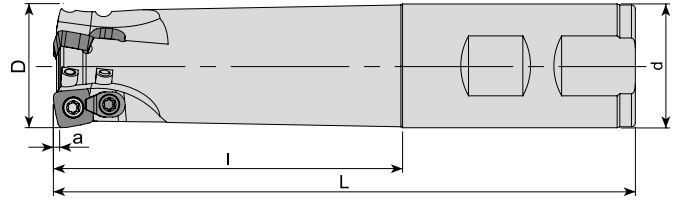

Takım Kodu Ordering Code	Stok Stock	Takım Ölçüleri (mm) Dimension (mm)						Kesici Uç Insert	Yedek Parçaları Spare Parts			
		D	Z	d	L	l	a		Sıkma Vidası Screw	Baskı Parçası Wedge Clamp	Baskı Vidası Clamp Screw	Tork Anahtar Torx Key
AHFMC-SD09T3-D25-C25-L150-Z02	●	25	2	25	150	100	1.4	SD.. 09T3..				
AHFMC-SD09T3-D25-W25-L150-Z02	●	25	2	25	150	100	1.4					
AHFMC-SD09T3-D32-C32-L150-Z03	●	32	3	32	150	100	1.4					
AHFMC-SD09T3-D32-W32-L150-Z03	●	32	3	32	150	100	1.4					

ZCC Ucuna Uygun. / Compatible with ZCC Insert.

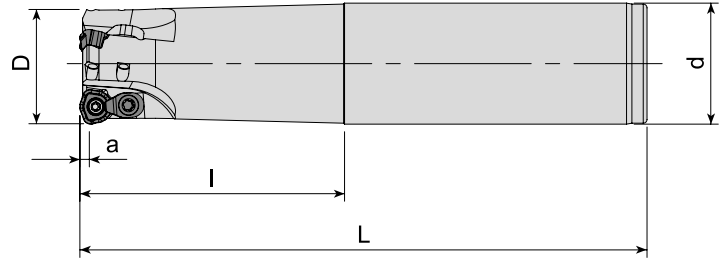

Takım Kodu Ordering Code	Stok Stock	Takım Ölçüleri (mm) Dimension (mm)						Kesici Uç Insert	Yedek Parçaları Spare Parts			
		D	Z	d	L	l	a		Sıkma Vidası Screw	Baskı Parçası Wedge Clamp	Baskı Vidası Clamp Screw	Tork Anahtar Torx Key
AHFM-WD0603-D16-C16-L150-Z02	●	16	2	16	150	70	2	WDMT 0603..				
AHFM-WD0603-D20-C20-L150-Z03	●	20	3	20	150	70	2					
AHFMC-WD0804-D25-C25-L150-Z02	●	25	2	25	150	70	2.5	WDMT 0804..				
AHFMC-WD0804-D32-C32-L150-Z03	●	32	3	32	150	70	2.5					
AHFMC-WD1205-D32-C32-L150-Z02	●	32	2	32	150	70	3	WDMT 1205..				

R: Sağ/Right L: Sol/Left ● Stokta/In Stock ○ Stokta Yok/Non Stock Item
SMTM Ucuna Uygun. / Compatible with SMTM Insert.

Sipariş Örneği/Ordering Example : 1 ad./pcs. AHFMC-SD09T3-D25-C25-L150-Z02
Kesme Hesabı : S 271 / Cutting Calculation : P 271

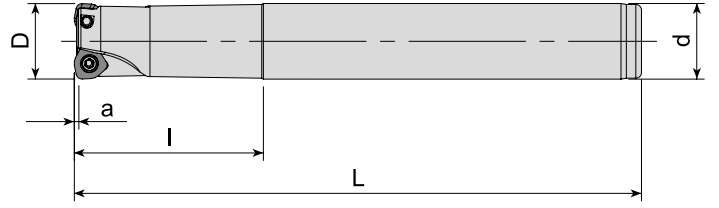

Takım Kodu Ordering Code	Stok Stock	Takım Ölçüleri (mm) Dimension (mm)						Kesici Uç Insert	Yedek Parçaları Spare Parts			
		D	Z	d	L	l	a		Sıkma Vidası Screw	Baskı Parçası Wedge Clamp	Baskı Vidası Clamp Screw	Tork Anahtar Torx Key
AHFM-WD0503D-D20-C20-L150-Z02	●	20	2	20	150	50	1.25	WD.W 0503..	4010-M3x6	-	-	80-T10
AHFM-WD0503D-D21-C20-L150-Z02	●	21	2	20	150	30	1.25					
AHFMC-WD06T3D-D26-C25-L200-Z02	●	26	2	25	200	30	1.5	WD.W 06T3..	3015-M3.5x9	ACK-15	1015-M3.5x11	80-T15
AHFMC-WD06T3D-D33-C32-L200-Z03	●	33	3	32	200	32	1.5					

DJT Ucuna Uygundur. / Compatible with DJT Insert.

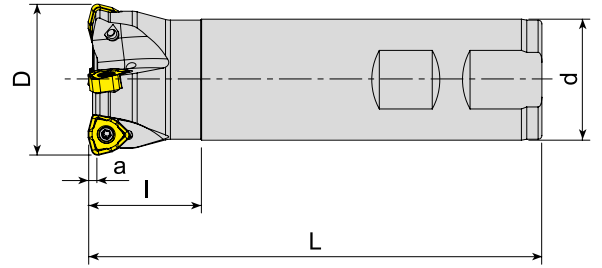





Takım Kodu Ordering Code	Stok Stock	Takım Ölçüleri (mm) Dimension (mm)						Kesici Uç Insert	Yedek Parçaları Spare Parts	
		D	Z	d	L	l	a		Sıkma Vidası Screw	Tork Anahtar Torx Key
AHFM-WN09T3-D25-W25-L120-Z02-H	●	25	2	25	120	40	1.5	WNMX 09T3..	4010-M3x8	80-T10
AHFML-WN09T3-D25-W25-L120-Z02-H	●	25	2	25	120	40	1.5			
AHFM-WN09T3-D25-C25-L200-Z02	●	25	2	25	200	120	1.5			
AHFM-WN09T3-D32-W32-L120-Z03-H	●	32	3	32	120	30	1.5			
AHFM-WN09T3-D40-W32-L120-Z04-H	●	40	4	32	120	30	1.5			
AHFM-WN09T3-D40-C32-L200-Z04	●	40	4	32	200	30	1.5			

R: Sağ/Right L: Sol/Left ● Stokta/In Stock ○ Stokta Yok/Non Stock Item
KRLY Ucuna Uygundur. / Compatible with KRLY Insert.

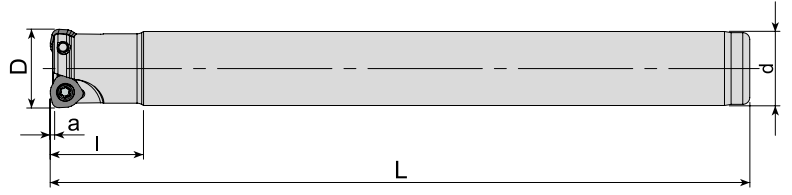
Sipariş Örneği/Ordering Example : 1 ad./pcs. AHFM-WD0503D-D20-C20-L150-Z02
Kesme Hesabı : S 271 / Cutting Calculation : P 271

> S-SİSTEM HIZLI İLERLEMELİ PARMAK FREZELER
S-SYSTEM HIGHFEED END MILLS



Takım Kodu Ordering Code	Stok Stock	Takım Ölçüleri (mm) Dimension (mm)						Kesici Uç Insert	Yedek Parçaları Spare Parts	
		D	Z	d	L	l	a		Sıkma Vidası Screw	Tork Anahtar Torx Key
AHFM-W004T2D-D16-C16-L150-Z02	●	16	2	16	150	20	0.8			
AHFM-W004T2D-D17-C16-L150-Z02	●	17	2	16	150	20	0.8			



DJT Ucuna Uygunur. / Compatiple with DJT Insert.

> S-SİSTEM MODÜLER PARMAK FREZELER
S-SYSTEM MODULAR END MILLS (SCREW TYPE TOOLS)

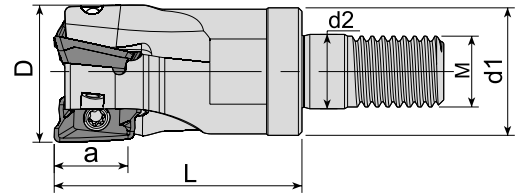

90°



Takım Kodu Ordering Code	Stok Stock	Takım Ölçüleri (mm) Dimension (mm)							Kesici Uç Insert	Yedek Parçaları Spare Parts	
		D	Z	d1	M	L	d2	a		Sıkma Vidası Screw	Tork Anahtar Torx Key
AEM90-A01236-D16-M08-L30-Z02	●	16	2	14.8	M08	30	8.5	12			
AEM90-A01236-D20-M10-L35-Z03	●	20	3	18	M10	35	10.5	12			

R: Sağ/Right L: Sol/Left ● Stokta/In Stock ○ Stokta Yok/Non Stock Item
MTSBH Ucuna Uygunur. / Compatiple with MTSBH Insert.



Sipariş Örneği/Ordering Example : 1 ad./pcs. AHFM-W004T2D-D16-C16-L150-Z02
Kesme Hesabı : S 271 / Cutting Calculation : P 271
Sıkma Tork Değeri : S 271 / Tightening Torque : P 271



www.akkо.com.tr

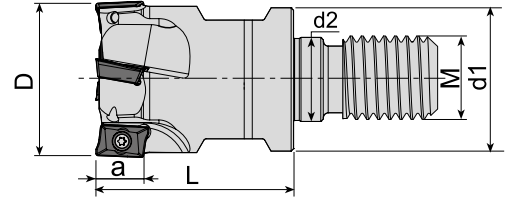



Дистрибьютер ООО "Ресурс Плюс"
+7 (351) 247-74-40; info@rp-ural.ru

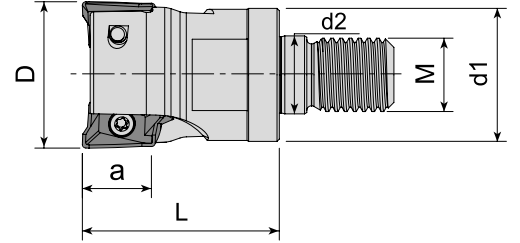

Takım Kodu Ordering Code	Stok Stock	Takım Ölçüleri (mm) Dimension (mm)							Kesici Uç Insert	Yedek Parçaları Spare Parts	
		D	Z	d1	M	L	d2	a		Sıkma Vidası Screw	Tork Anahtar Torx Key
AEM90-AD1505D-D25-M12-L43-Z02-H	●	25	2	21	M12	43	12.5	14.3			
AEM90-AD1505D-D32-M16-L43-Z03-H	●	32	3	29	M16	43	17	14.3			

DJT Ucuna Uygundur. / Compatible with DJT Insert.

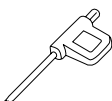

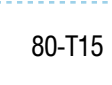





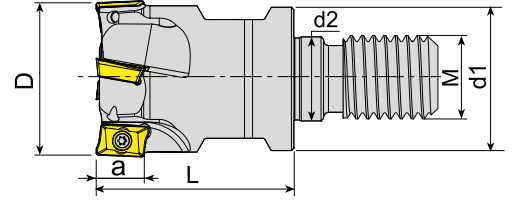

Takım Kodu Ordering Code	Stok Stock	Takım Ölçüleri (mm) Dimension (mm)							Kesici Uç Insert	Yedek Parçaları Spare Parts				
		D	Z	d1	M	L	d2	a		Sıkma Vidası Screw	Tork Anahtar Torx Key			
AEM90-AX1235-D16-M08-L30-Z02-H	●	16	2	14.75	M08	30	8.5	10						
AEM90-AX1235-D20-M10-L30-Z03-H	●	20	3	18	M10	30	10.5	10				AX.T 1235..	1008-M3x6	80-T08
AEM90-AX1235-D25-M12-L35-Z04-H	●	25	4	21	M12	35	12.5	10						
AEM90-AX1705-D25-M12-L43-Z02-H	●	25	2	21	M12	43	12.5	14				AX.T 1705..	1515-M4x9	80-T15
AEM90-AX1705-D32-M16-L43-Z02-H	●	32	2	29	M16	43	17	14						

R: Sağ/Right L: Sol/Left ● Stokta/In Stock ○ Stokta Yok/Non Stock Item
SMTM Ucuna Uygundur. / Compatible with SMTM Insert.

Sipariş Örneği/Ordering Example : 1 ad./pcs. AEM90-AD1505D-D25-M12-L43-Z02-H
Kesme Hesabı : S 271 / Cutting Calculation : P 271
Sıkma Tork Değeri : S 271 / Tightening Torque : P 271



Takım Kodu Ordering Code	Stok Stock	Takım Ölçüleri (mm) Dimension (mm)							Kesici Uç Insert	Yedek Parçaları Spare Parts	
		D	Z	d1	M	L	d2	a		Sıkma Vidası Screw	Tork Anahtar Torx Key
AEM90-AP10-D16-M08-L30-Z02-H	●	16	2	14.75	M08	30	8.5	10	 AP.. 1003.. ISO UCUNA UYGUNDUR. FOR ISO INSERT.	 3008-M2.5x6	 80-T08
AEM90-AP10-D20-M10-L30-Z03-H	●	20	3	18	M10	30	10.5	10			
AEM90-AP10-D25-M12-L35-Z03-H	●	25	3	21	M12	35	12.5	10			
AEM90-AP10-D32-M16-L35-Z04-H	●	32	4	29	M16	35	17	10			
AEM90-AP10-D40-M16-L43-Z05-H	●	40	5	29	M16	43	17	10			
AEM90-AP10-D42-M16-L43-Z05-H	●	42	5	29	M16	43	17	10			
AEM90-AP10D-D16-M08-L30-Z02-H	●	16	2	14.75	M08	30	8.5	10	 AP.. 1003.. DJT UCUNA UYGUNDUR. FOR DJT INSERT.	3008-M2.5x6	80-T08
AEM90-AP10D-D20-M10-L30-Z03-H	●	20	3	18	M10	30	10.5	10			
AEM90-AP10D-D25-M12-L35-Z03-H	●	25	3	21	M12	35	12.5	10			
AEM90-AP11-D16-M08-L30-Z02-H	●	16	2	14.75	M08	30	8.5	11	 AP.. 11T3.. ZCC UCUNA UYGUNDUR. FOR ZCC INSERT.	3008-M2.5x6	80-T08
AEM90-AP11-D20-M10-L30-Z03-H	●	20	3	18	M10	30	10.5	11			
AEM90-AP11-D25-M12-L35-Z03-H	●	25	3	21	M12	35	12.5	11			
AEM90-AP11-D32-M16-L35-Z04-H	●	32	4	29	M16	35	17	11			
AEM90-AP11-D40-M16-L43-Z05-H	●	40	5	29	M16	43	17	11	 AP.. 1604.. ISO UCUNA UYGUNDUR. FOR ISO INSERT.	1515-M4x9	80-T15
AEM90-AP16-D25-M12-L43-Z02-H	●	25	2	21	M12	43	12.5	16			
AEM90-AP16-D32-M16-L43-Z03-H	●	32	3	29	M16	43	17	16			
AEM90-AP16-D40-M16-L43-Z04-H	●	40	4	29	M16	43	17	16			
AEM90-AP16-D42-M16-L43-Z04	●	42	4	29	M16	43	17	16			
AEM90-AP16D-D25-M12-L43-Z02-H	●	25	2	21	M12	43	12.5	16			
AEM90-AP16D-D32-M16-L43-Z03-H	●	32	3	29	M16	43	17	16	 AP.. 1604.. DJT UCUNA UYGUNDUR. FOR DJT INSERT.	1515-M4x9	80-T15
AEM90-AP16D-D40-M16-L43-Z04-H	●	40	4	29	M16	43	17	16			
AEM90-AP16L-D25-M12-L43-Z02-H	●	25	2	21	M12	43	12.5	16	 AP.. 1604.. LMN UCUNA UYGUNDUR. FOR LMN INSERT.	1515-M4x9	80-T15
AEM90-AP16L-D32-M16-L43-Z03-H	●	32	3	29	M16	43	17	16			
AEM90-AP16L-D40-M16-L43-Z04-H	●	40	4	29	M16	43	17	16			

R: Sağ/Right L: Sol/Left ● Stokta/In Stock ○ Stokta Yok/Non Stock Item

Sipariş Örneği/Ordering Example : 1 ad./pcs. AEM90-AP10-D16-M08-L30-Z02-H

Kesme Hesabı : S 271 / Cutting Calculation : P 271

Sıkma Tork Değeri : S 271 / Tightening Torque : P 271



90°

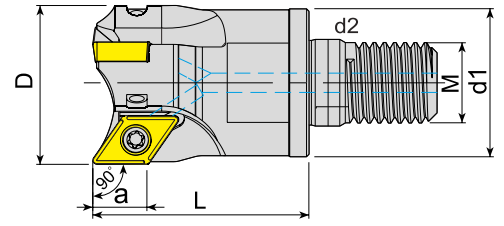

Takım Kodu Ordering Code	Stok Stock	Takım Ölçüleri (mm) Dimension (mm)							Kesici Uç Insert	Yedek Parçaları Spare Parts	
		D	Z	d1	M	L	d2	a		Sıkma Vidası Screw	Tork Anahtar Torx Key
AEM90-DC07-D20-M10-L30-Z02-H	●	20	2	18	M10	30	10.5	7	DC.T 0702.	4008-M2.5x6	80-T08
AEM90-DC07-D25-M12-L35-Z03-H	●	25	3	21	M12	35	12.5	7			
AEM90-DC07-D32-M16-L43-Z04-H	●	32	4	29	M16	43	17	7			
AEM90-DC07-D40-M16-L43-Z05-H	●	40	5	29	M16	43	17	7			
AEM90-DC11-D32-M16-L43-Z03-H-F	●	32	3	29	M16	43	17	11	DC.T 11T3..	4015-M3.5x9	80-T15
AEM90-DC11-D40-M16-L43-Z03-H-F	●	40	3	29	M16	43	17	11			

F: Çap toleransı +, - 0,02 mm içerisinde anlamına gelmektedir. / F: Diameter tolerance is between +, - 0,02 mm.
ISO Ucuna Uygunudur. / Compatible with ISO Insert.

90°

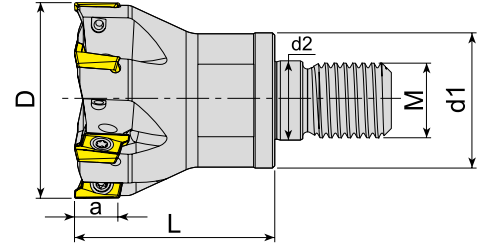

Takım Kodu Ordering Code	Stok Stock	Takım Ölçüleri (mm) Dimension (mm)							Kesici Uç Insert	Yedek Parçaları Spare Parts	
		D	Z	d1	M	L	d2	a		Sıkma Vidası Screw	Tork Anahtar Torx Key
AEM90-RT10-D16-M08-L20-Z02-H	●	16	2	14.75	M08	20	8.5	10	RT 1003..	3008-M2.5x6	80-T08
AEM90-RT10-D20-M10-L25-Z03-H	●	20	3	18	M10	25	10.5	10			
AEM90-RT10-D25-M12-L30-Z04-H	●	25	4	21	M12	30	12.5	10			
AEM90-RT10-D32-M16-L43-Z05-H	●	32	5	29	M16	43	17	10			
AEM90-RT10-D42-M16-L43-Z06-H	●	42	6	29	M16	43	17	10			

R: Sağ/Right L: Sol/Left ● Stokta/In Stock ○ Stokta Yok/Non Stock Item
SFTY Ucuna Uygunudur. / Compatible with SFTY Insert.

Sipariş Örneği/Ordering Example : 1 ad./pcs. AEM90-DC07-D20-M10-L30-Z02-H
Kesme Hesabı : S 271 / Cutting Calculation : P 271
Sıkma Tork Değeri : S 271 / Tightening Torque : P 271

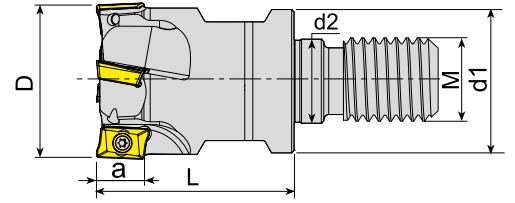

Takım Kodu Ordering Code	Stok Stock	Takım Ölçüleri (mm) Dimension (mm)							Kesici Uç Insert	Yedek Parçaları Spare Parts	
		D	Z	d1	M	L	d2	a		Sıkma Vidası Screw	Tork Anahtar Torx Key
AEM90-R390.11-D16-M08-L30-Z02-H	●	16	2	14.75	M08	30	8.5	10			
AEM90-R390.11-D20-M10-L30-Z03-H	●	20	3	18	M10	30	10.5	10			
AEM90-R390.11-D25-M12-L35-Z03-H	●	25	3	21	M12	35	12.5	10			
AEM90-R390.11-D32-M16-L43-Z04-H	●	32	4	29	M16	43	17	10			

SNDVK Ucuna Uygun. / Compatible with SNDVK Insert.

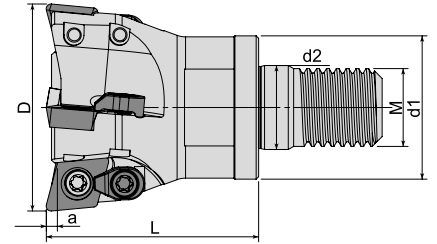

Takım Kodu Ordering Code	Stok Stock	Takım Ölçüleri (mm) Dimension (mm)							Kesici Uç Insert	Yedek Parçaları Spare Parts			
		D	Z	d1	M	L	d2	a		Sıkma Vidası Screw	Baskı Parçası Wedge Clamp	Baskı Vidası Clamp Screw	Tork Anahtar Torx Key
AEM95-XD0206-D16-M08-L23-Z02-H	●	16	2	14.75	8	23	8.5	1					
AEM95-XD0206-D16-M08-L23-Z02-H-F	●	16	2	14.75	8	23	8.5	1					
AEM95-XD0206-D20-M10-L30-Z03-H	●	20	3	18	10	30	10.5	1					
AEM95-XD0206-D20-M10-L30-Z03-H-F	●	20	3	18	10	30	10.5	1					
AEM95-XD0206-D25-M12-L35-Z03-H	●	25	3	21	12	35	12.5	1					
AEM95-XD0206-D25-M12-L35-Z03-H-F	●	25	3	21	12	35	12.5	1					
AEM95C-XD0310-D35-M16-L43-Z03-H	●	35	3	29	16	43	17	1.5					
AEM95C-XD0310-D35-M16-L43-Z03-H-F	●	35	3	29	16	43	17	1.5					
AEM95C-XD0310-D42-M16-L43-Z04-H	●	42	4	29	16	43	17	1.5					
AEM95C-XD0310-D42-M16-L43-Z04-H-F	●	42	4	29	16	43	17	1.5					

R: Sağ/Right L: Sol/Left ● Stokta/In Stock ○ Stokta Yok/Non Stock Item
DJT Ucuna Uygun. / Compatible with DJT Insert.

F: Çap toleransı +, -, 0,02 mm içerisinde anlamına gelmektedir. / F: Diameter tolerance is between +, -, 0,02 mm.

Sipariş Örneği/Ordering Example : 1 ad./pcs. AEM90-R390.11-D16-M08-L30-Z02-H
Kesme Hesabı : S 271 / Cutting Calculation : P 271
Sıkma Tork Değeri : S 271 / Tightening Torque : P 271

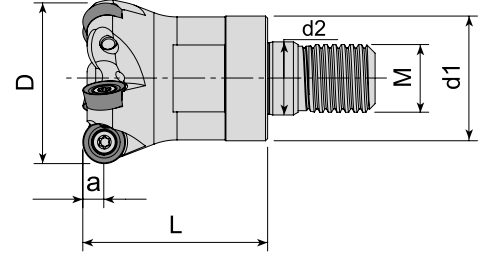

Takım Kodu Ordering Code	Stok Stock	Takım Ölçüleri (mm) Dimension (mm)							Kesici Uç Insert	Yedek Parçaları Spare Parts	
		D	Z	d1	M	L	d2	a		Sıkma Vidası Screw	Tork Anahtar Torx Key
AEMR-RC10T3-D25-M12-L35-Z03-H	●	25	3	21	M12	35	12.5	5	RC.. 10T3..	1515-M4x9	80-T15
AEMR-RC10T3-D32-M16-L43-Z04-H	●	32	4	29	M16	43	17	5			
AEMR-RC10T3-D40-M16-L43-Z05-H	●	40	5	29	M16	43	17	5			

ZCC Ucuna Uygunudur. / Compatible with ZCC Insert.

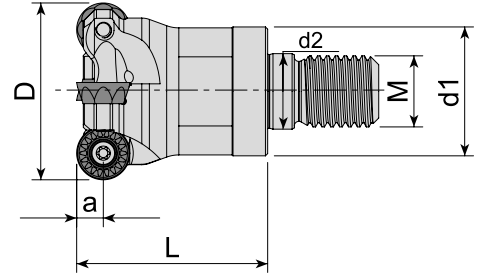

Takım Kodu Ordering Code	Stok Stock	Takım Ölçüleri (mm) Dimension (mm)							Kesici Uç Insert	Yedek Parçaları Spare Parts	
		D	Z	d1	M	L	d2	a		Sıkma Vidası Screw	Tork Anahtar Torx Key
AEMR-RP08T2M-D20-M10-L30-Z02-H	●	20	2	18	M10	30	10.5	4	RPMT 08T2..	3008-M2.5x6	80-T08
AEMR-RP10T3M-D25-M12-L35-Z02-H	●	25	2	21	M12	35	12.5	5	RPMT 10T3..	4015-M3.5x9	80-T15
AEMR-RP10T3M-D32-M16-L43-Z03-H	●	32	3	29	M16	43	17	5			
AEMR-RP1204M-D32-M16-L43-Z03-H	●	32	3	29	M16	43	17	6	RPMT 1204..	4015-M4X9	80-T15
AEMR-RP1204M-D40-M16-L43-Z04-H	●	40	4	29	M16	43	17	6			

R: Sağ/Right L: Sol/Left ● Stokta/In Stock ○ Stokta Yok/Non Stock Item
MTSBH Ucuna Uygunudur. / Compatible with MTSBH Insert.

Sipariş Örneği/Ordering Example : 1 ad./pcs. AEMR-RC10T3-D25-M12-L35-Z03-H
Kesme Hesabı : S 271 / Cutting Calculation : P 271
Sıkma Tork Değeri : S 271 / Tightening Torque : P 271

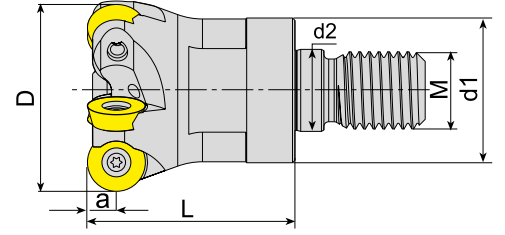

Takım Kodu Ordering Code	Stok Stock	Takım Ölçüleri (mm) Dimension (mm)							Kesici Uç Insert	Yedek Parçaları Spare Parts	
		D	Z	d1	M	L	d2	a		Sıkma Vidası Screw	Tork Anahtar Torx Key
AEMR-RD0702-D15-M08-L23-Z02-H	●	15	2	13	M08	23	8.5	3.5	RD.. 0702	3008-M2.5x6	80-T08
AEMR-RD0702-D16-M08-L23-Z02-H	●	16	2	13	M08	23	8.5	3.5			
AEMR-RD0702-D20-M10-L30-Z04-H	●	20	4	18	M10	30	10.5	3.5			
AEMR-RD0702-D25-M12-L35-Z05-H	●	25	5	21	M12	35	12.5	3.5			
AEMR-RD0702-D30-M16-L42-Z05-H	●	30	5	29	M16	42	17	3.5			
AEMR-RD0702-D32-M16-L43-Z05-H	●	32	5	29	M16	43	17	3.5			
AEMR-RD0702-D35-M16-L42-Z06-H	●	35	6	29	M16	42	17	3.5			
AEMR-RD0702-D42-M16-L43-Z05-H	●	42	5	29	M16	43	17	3.5			
AEMR-RD0702-D42-M16-L43-Z07-H	●	42	7	29	M16	43	17	3.5			
AEMR-RD08T2-D16-M08-L23-Z02-H	●	16	2	13	M08	23	8.5	4	RD.. 08T2	3008-M2.5x6	80-T08
AEMR-RD08T2-D20-M10-L30-Z03-H	●	20	3	18	M10	30	10.5	4			
AEMR-RD08T2-D25-M12-L35-Z04-H	●	25	4	21	M12	35	12.5	4			
AEMR-RD0803-D16-M08-L23-Z02-H	●	16	2	13	M08	23	8.5	4	RD.. 0803	1008-M3x6	80-T15
AEMR-RD0803-D20-M10-L30-Z03-H	●	20	3	18	M10	30	10.5	4		1008-M3x8	
AEMR-RD0803-D25-M12-L35-Z04-H	●	25	4	21	M12	35	12.5	4			
AEMR-RD1003-D20-M10-L30-Z02-H	●	20	2	18	M10	30	10.5	5	RD.. 1003	4015-M3.5x9	80-T15
AEMR-RD1003-D25-M12-L35-Z02-H	●	25	2	21	M12	35	12.5	5			
AEMR-RD1003-D25-M12-L35-Z03-H	●	25	3	21	M12	35	12.5	5			
AEMR-RD1003-D30-M16-L43-Z04-H	●	30	4	29	M16	43	17	5			
AEMR-RD1003-D32-M16-L43-Z04-H	●	32	4	29	M16	43	17	5			
AEMR-RD1003-D35-M16-L43-Z04-H	●	35	4	29	M16	43	17	5			
AEMR-RD1003-D40-M16-L43-Z05-H	●	40	5	29	M16	43	17	5			
AEMR-RD1003-D42-M16-L43-Z05-H	●	42	5	29	M16	43	17	5			
AEMR-RD12T3-D24-M12-L35-Z02-H	●	24	2	21	M12	35	12.5	6	RD.. 12T3	4015-M3.5x9	80-T15
AEMR-RD12T3-D25-M12-L35-Z02-H	●	25	2	21	M12	35	12.5	6			
AEMR-RD12T3-D32-M16-L43-Z03-H	●	32	3	29	M16	43	17	6			
AEMR-RD12T3-D35-M16-L43-Z03-H	●	35	3	29	M16	43	17	6			
AEMR-RD12T3-D35-M16-L43-Z04-H	●	35	4	29	M16	43	17	6			
AEMR-RD12T3-D40-M16-L43-Z04-H	●	40	4	29	M16	43	17	6			
AEMR-RD12T3-D42-M16-L43-Z05-H	●	42	5	29	M16	43	17	6			
AEMR-RD1204-D32-M16-L43-Z03-H	●	32	3	29	M16	43	17	6	RD.. 1204	4015-M3.5x9	80-T15
AEMR-RD1204-D42-M16-L43-Z04-H	●	42	4	29	M16	43	17	6			
AEMR-RD1604-D32-M16-L43-Z02-H	●	32	2	29	M16	43	17	8	RD.. 1604	1515-M4.5X11	80-T15
AEMR-RD1604-D40-M16-L43-Z02-H	●	40	2	29	M16	43	17	8			
AEMR-RD1604-D42-M16-L43-Z03-H	●	42	3	29	M16	43	17	8			

R: Sağ/Right L: Sol/Left ● Stokta/In Stock ○ Stokta Yok/Non Stock Item
ISO Ucuna Uygundur. / Compatible with ISO Insert.

Sipariş Örneği/Ordering Example : 1 ad./pcs. AEMR-RD0702-D15-M08-L23-Z02-H
Kesme Hesabı : S 271 / Cutting Calculation : P 271
Sıkma Tork Değeri : S 271 / Tightening Torque : P 271



www.akko.com.tr

Дистрибьютер ООО "Ресурс Плюс"
+7 (351) 247-74-40; info@rp-ural.ru

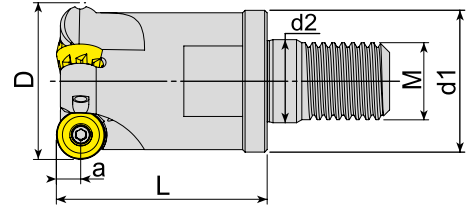

Takım Kodu Ordering Code	Stok Stock	Takım Ölçüleri (mm) Dimension (mm)							Kesici Uç Insert	Yedek Parçaları Spare Parts	
		D	Z	d1	M	L	d2	a		Sıkma Vidası Screw	Tork Anahtar Torx Key
AEMR-RP10T3-D25-M12-L35-Z02-H	●	25	2	21	12	35	12.5	5	RPNX 10T3..	4010-M3x8	80-T10
AEMR-RP10T3-D32-M16-L43-Z03-H	●	32	3	29	16	43	17	5			

CRTZT Ucuna Uygunudur. / Compatible with CRTZT Insert.

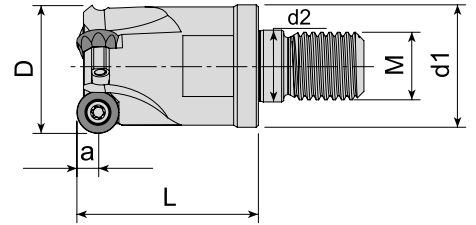

Takım Kodu Ordering Code	Stok Stock	Takım Ölçüleri (mm) Dimension (mm)							Kesici Uç Insert	Yedek Parçaları Spare Parts	
		D	Z	d1	M	L	d2	a		Sıkma Vidası Screw	Tork Anahtar Torx Key
AEMR-QP10T3-D25-M12-L35-Z02-H	●	25	2	21	M12	35	12.5	5	QP.. 10T3..	4015-M3.5x9	80-T15
AEMR-QP10T3-D32-M16-L43-Z03-H	●	32	3	29	M16	43	17	5			

R: Sağ/Right L: Sol/Left ● Stokta/In Stock ○ Stokta Yok/Non Stock Item
SMTM Ucuna Uygunudur. / Compatible with SMTM Insert.

Sipariş Örneği/Ordering Example : 1 ad./pcs. AEMR-RP10T3-D25-M12-L35-Z02-H
Kesme Hesabı : S 271 / Cutting Calculation : P 271
Sıkma Tork Değeri : S 271 / Tightening Torque : P 271

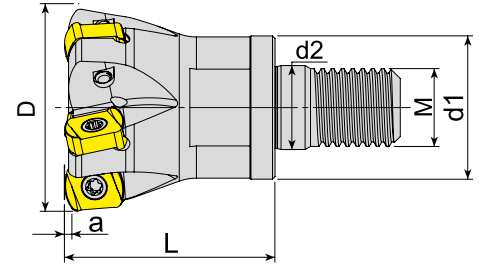

Takım Kodu Ordering Code	Stok Stock	Takım Ölçüleri (mm) Dimension (mm)							Kesici Uç Insert	Yedek Parçaları Spare Parts	
		D	Z	d1	M	L	d2	a		Sıkma Vidası Screw	Tork Anahtar Torx Key
AHFM-BL0603-D32-M16-L40-Z05-H	●	32	5	29	M16	40	17	1		3008-M2.5x6	80-T08
AHFM-BL0904-D42-M16-L43-Z05-H	●	42	5	29	M16	43	17	2		1510-M3.5x9	80-T10

TGTC Ucuna Uygunur. / Compatiple with TGTC Insert.

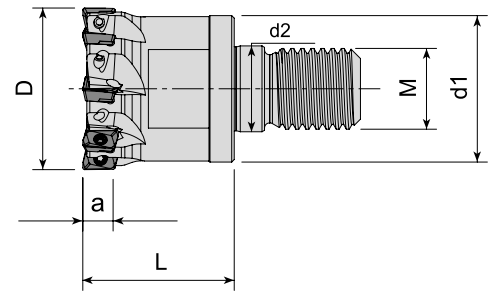

Takım Kodu Ordering Code	Stok Stock	Takım Ölçüleri (mm) Dimension (mm)							Kesici Uç Insert	Yedek Parçaları Spare Parts	
		D	Z	d1	M	L	d2	a		Sıkma Vidası Screw	Tork Anahtar Torx Key
AHFM-ED0702-D12-M06-L20-Z03	●	12	3	10	M06	20	6.5	6			
AHFM-ED0702-D16-M08-L25-Z04-H	●	16	4	14.75	M08	25	8.5	6			
AHFM-ED0702-D20-M10-L30-Z05-H	●	20	5	18	M10	30	10.5	6			
AHFM-ED0702-D25-M12-L30-Z06-H	●	25	6	21	M12	30	12.5	6			
AHFM-ED0702-D32-M16-L30-Z08-H	●	32	8	29	M16	30	17	6			

R: Sağ/Right L: Sol/Left ● Stokta/In Stock ○ Stokta Yok/Non Stock Item
HTCH Ucuna Uygunur. / Compatiple with HTCH Insert.



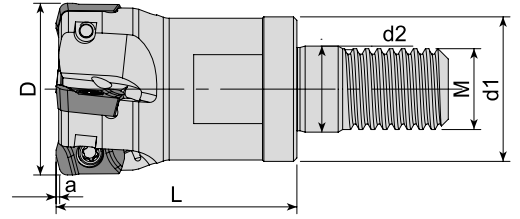

Sipariş Örneği/Ordering Example : 1 ad./pcs. AHFM-BL0603-D32-M16-L40-Z05-H
Kesme Hesabı : S 271 / Cutting Calculation : P 271
Sıkma Tork Değeri : S 271 / Tightening Torque : P 271

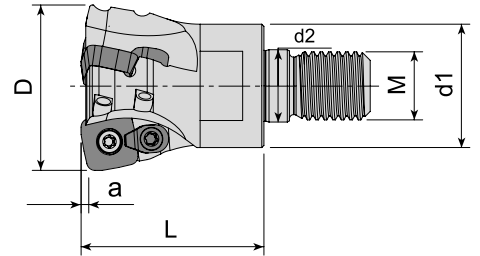

Takım Kodu Ordering Code	Stok Stock	Takım Ölçüleri (mm) Dimension (mm)							Kesici Uç Insert	Yedek Parçaları Spare Parts		
		D	Z	d1	M	L	d2	a		Sıkma Vidası Screw	Tork Anahtar Torx Key	
AHFM-EP1003-D16-M08-L23-Z02-H	●	16	2	14.75	8	23	8.5	1	 EP.. 1003.. ZPMT 1003.. YPHW 1003..	3008-M2.5x5.5	 80-T08	
AHFM-EP1003-D20-M10-L30-Z04-H	●	20	4	18	10	30	10.5	1				
AHFM-EP1003-D25-M12-L35-Z04-H	●	25	4	21	12	35	12.5	1				
AHFM-EP1003-D32-M16-L43-Z05-H	●	32	5	29	16	43	17	1				
AHFM-EP1003-D35-M16-L43-Z05-H	●	35	5	29	16	43	17	1				
AHFM-EP1003-D42-M16-L43-Z06-H	●	42	6	29	16	43	17	1		3008-M2.5x6		

DJT Ucuna Uygundur. / Compatible with DJT Insert.



Takım Kodu Ordering Code	Stok Stock	Takım Ölçüleri (mm) Dimension (mm)							Kesici Uç Insert	Yedek Parçaları Spare Parts			
		D	Z	d1	M	L	d2	a		Sıkma Vidası Screw	Baskı Parçası Wedge Clamp	Baskı Vidası Clamp Screw	Tork Anahtar Torx Key
AHFMC-SD09T3-D22-M12-L30-Z02-H	○	22	2	21	M12	30	12.5	1.4	 SD.. 09T3..	3015-M3.5x9	 ACK-15	 1015-M3.5x11	 80-T15
AHFMC-SD09T3-D25-M12-L30-Z02-H	●	25	2	22	M12	30	12.5	1.4					
AHFMC-SD09T3-D32-M16-L43-Z03-H	●	32	3	29	M16	43	17	1.4					
AHFMC-SD09T3-D35-M16-L43-Z03-H	●	35	3	29	M16	43	17	1.4					
AHFMC-SD09T3-D40-M16-L43-Z04-H	●	40	4	29	M16	43	17	1.4					
AHFMC-SD1204-D32-M16-L43-Z02-H	●	32	2	29	M16	43	17	1.8		 1515-M4x9			
AHFMC-SD1204-D40-M16-L43-Z03-H	●	40	3	29	M16	43	17	1.8					

R: Sağ/Right L: Sol/Left ● Stokta/In Stock ○ Stokta Yok/Non Stock Item
ZCC Ucuna Uygundur. / Compatible with ZCC Insert.

Sipariş Örneği/Ordering Example : 1 ad./pcs. AHFM-EP1003-D16-M08-L23-Z02-H
Kesme Hesabı : S 271 / Cutting Calculation : P 271

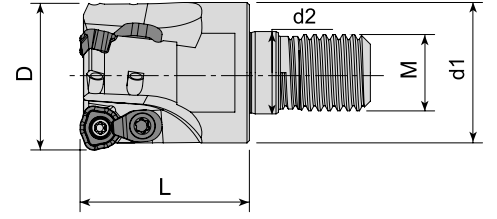

Takım Kodu Ordering Code	Stok Stock	Takım Ölçüleri (mm) Dimension (mm)							Kesici Uç Insert	Yedek Parçaları Spare Parts			
		D	Z	d1	M	L	d2	a		Sıkma Vidası Screw	Baskı Parçası Wedge Clamp	Baskı Vidası Clamp Screw	Tork Anahtar Torx Key
AHFMC-WD0804-D25-M12-L35-Z02-H	●	25	2	21	M12	35	12.5	-	WDMT 0804..	4010-M3x8	ACK-15	4010-M3x8	80-T10
AHFMC-WD0804-D32-M16-L35-Z03-H	●	32	3	29	M16	35	17	-					

SMTM Ucuna Uygun. / Compatible with SMTM Insert.

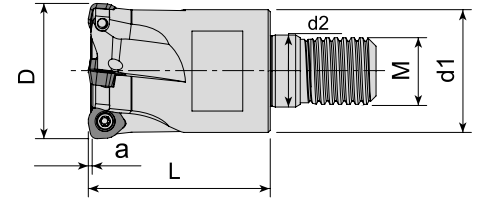

Takım Kodu Ordering Code	Stok Stock	Takım Ölçüleri (mm) Dimension (mm)							Kesici Uç Insert	Yedek Parçaları Spare Parts			
		D	Z	d1	M	L	d2	a		Sıkma Vidası Screw	Baskı Parçası Wedge Clamp	Baskı Vidası Clamp Screw	Tork Anahtar Torx Key
AHFM-WD0503D-D20-M10-L30-Z02-H	●	20	2	18	M10	30	10.5	1.25	WDMT 0503..	4010-M3x6	-	-	80-T10
AHFM-WD0503D-D25-M12-L35-Z03-H	●	25	3	21	M12	35	12.5	1.25		4010-M3x8			
AHFM-WD0503D-D32-M16-L43-Z04-H	●	32	4	29	M16	43	17	1.25					
AHFM-WD0503D-D40-M16-L43-Z05-H	●	40	5	29	M16	43	17	1.25					
AHFMC-WD06T3D-D35-M16-L43-Z03-H	●	35	3	29	M16	43	17	1.5	WDHW 06T3..	3015-M3.5x9	ACK-15	1015-M3.5x11	80-T15
AHFMC-WD0805D-D32-M16-L43-Z02-H	●	32	2	29	M16	43	17	2	WDHW 0805..	4020-M4.5x10	ACK-19	4020-M4.5x12	

R: Sağ/Right L: Sol/Left ● Stokta/In Stock ○ Stokta Yok/Non Stock Item
DJT Ucuna Uygun. / Compatible with DJT Insert.

Sipariş Örneği/Ordering Example : 1 ad./pcs. AHFMC-WD0804-D25-M12-L35-Z02-H
Kesme Hesabı : S 271 / Cutting Calculation : P 271
Sıkma Tork Değeri : S 271 / Tightening Torque : P 271

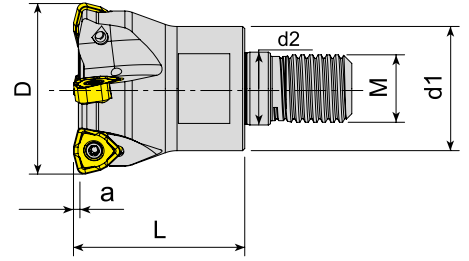

Takım Kodu Ordering Code	Stok Stock	Takım Ölçüleri (mm) Dimension (mm)							Kesici Uç Insert	Yedek Parçaları Spare Parts	
		D	Z	d1	M	L	d2	a		Sıkma Vidası Screw	Tork Anahtar Torx Key
AHFM-WN09T3-D32-M16-L40-Z03-H	●	32	3	29	M16	40	17	1.5			
AHFM-WN09T3-D40-M16-L40-Z04-H	●	40	4	29	M16	40	17	1.5			

KRLY Ucuna Uygundur. / Compatible with KRLY Insert.

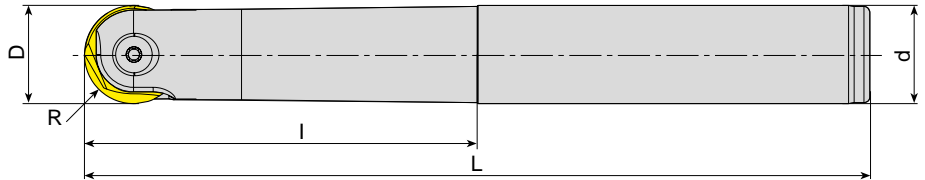

Takım Kodu Ordering Code	Stok Stock	Takım Ölçüleri (mm) Dimension (mm)					Kesici Uç Insert	Yedek Parçaları Spare Parts	
		D	R	d	L	I		Sıkma Vidası Screw	Anahtar Key
APMR-P3208-D08-C10-L110	●	8	4	10	110	25			
APMR-P3210-D10-C10-L130	●	10	5	10	130	30			
APMR-P3210-D10-C12-L130	●	10	5	12	130	30			
APMR-P3212-D12-C12-L130	●	12	6	12	130	32			
APMR-P3216-D16-C16-L175	●	16	8	16	175	60			
APMR-P3220-D20-C20-L200	●	20	10	20	200	100			
APMR-P3225-D25-C25-L200	●	25	12.5	25	200	100			
APMR-P3232-D32-C32-L200	●	32	16	32	200	100			

R: Sağ/Right L: Sol/Left ● Stokta/In Stock ○ Stokta Yok/Non Stock Item
WLTR Ucuna Uygundur. / Compatible with WLTR Insert.

Sipariş Örneği/Ordering Example : 1 ad./pcs. AHFM-WN09T3-D32-M16-L40-Z03-H
Kesme Hesabı : S 271 / Cutting Calculation : P 271

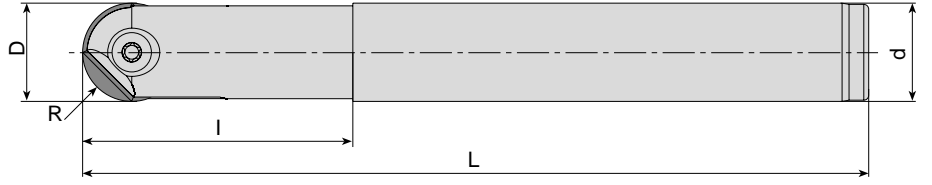

Takım Kodu Ordering Code	Stok Stock	Takım Ölçüleri (mm) Dimension (mm)					Kesici Uç Insert	Yedek Parçaları Spare Parts	
		D	R	d	L	l		Sıkma Vidası Screw	Tork Anahtar Torx Key
APMR-R012-D12-C12-L120	●	12	6	12	120	35		1215-M4x0.5x9	80-T15
APMR-R012-D12-C16-L160	●	12	6	16	160	50			
APMR-R016-D16-C16-L160	●	16	8	16	160	45		1220-M5x0.5x12	80-T20
APMR-R016-D16-C16-L200	●	16	8	16	200	45			
APMR-R016-D16-C20-L200	●	16	8	20	200	65		1220-M5x0.5x15	80-T20
APMR-R020-D20-C20-L160	●	20	10	20	160	55			
APMR-R020-D20-C20-L200	●	20	10	20	200	55			
APMR-R020-D20-C25-L220	●	20	10	25	220	80			

ZCC Ucuna Uygundur. / Compatible with ZCC Insert.

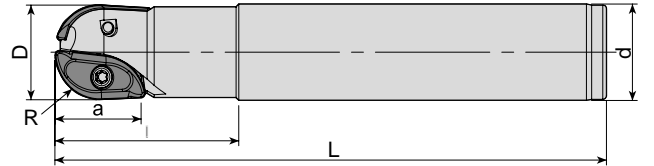

Takım Kodu Ordering Code	Stok Stock	Takım Ölçüleri (mm) Dimension (mm)					Kesici Uç Insert	Yedek Parçaları Spare Parts	
		D	R	d	L	l		Sıkma Vidası Screw	Tork Anahtar Torx Key
APMR-XP16-D16-C16-L150	●	16	8	16	150	40		3008-M2.5x6	80-T08
APMR-XP20-D20-C20-L150	●	20	10	20	150	50			
APMR-XP25-D25-C25-L150	●	25	12.5	25	150	50		4015-M4x9	80-T15

R: Sağ/Right L: Sol/Left ● Stokta/In Stock ○ Stokta Yok/Non Stock Item
ZCC Ucuna Uygundur. / Compatible with ZCC Insert.

Sipariş Örneği/Ordering Example : 1 ad./pcs. APMR-R012-D12-C12-L120
Kesme Hesabı : S 271 / Cutting Calculation : P 271

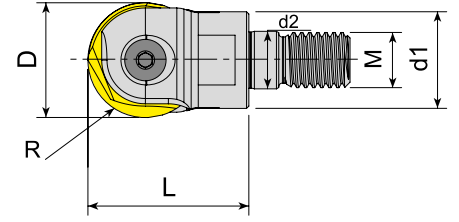

Takım Kodu Ordering Code	Stok Stock	Takım Ölçüleri (mm) Dimension (mm)						Kesici Uç Insert	Yedek Parçaları Spare Parts		
		D	R	d1	M	L	d2		Sıkma Vidası Screw	Tork Anahtar Torx Key	
APMR-P3216-D16-M08-L25	●	16	8	14	M08	25	8.5				
APMR-P3220-D20-M10-L30	●	20	10	18	M10	30	10.5			80-T20	
APMR-P3225-D25-M12-L35	●	25	12.5	21	M12	35	12.5				
APMR-P3232-D32-M16-L43	●	32	16	30	M16	43	17			AAL-05-4	

WLTR Ucuna Uygun. / Compatiple with WLTR Insert.

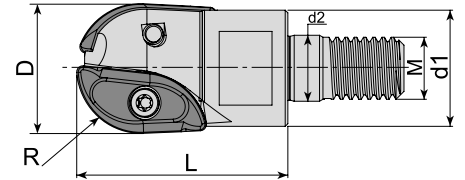

Takım Kodu Ordering Code	Stok Stock	Takım Ölçüleri (mm) Dimension (mm)						Kesici Uç Insert	Yedek Parçaları Spare Parts		
		D	R	d1	M	L	d2		Sıkma Vidası Screw	Tork Anahtar Torx Key	
APMR-SWB225-D25-M12-L35	●	25	12.5	23.5	M12	35	12.5				
APMR-SWB232-D32-M16-L43	●	32	16	30	M16	43	17			80-T20	

R: Sağ/Right L: Sol/Left ● Stokta/In Stock ○ Stokta Yok/Non Stock Item
DJT Ucuna Uygun. / Compatiple with DJT Insert.

Sipariş Örneği/Ordering Example : 1 ad./pcs. APMR-P3216-D16-M08-L25
Kesme Hesabı : S 271 / Cutting Calculation : P 271
Sıkma Tork Değeri : S 271 / Tightening Torque : P 271

➤ KÜRE UÇLU MODÜLER PARMAK FREZELER
BALL NOSE MODULAR (SCREW TYPE) END MILLS

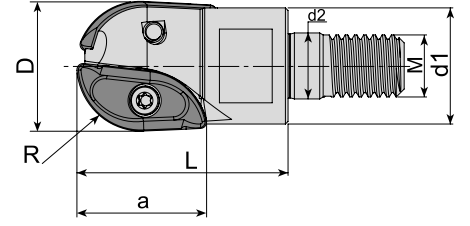

Takım Kodu Ordering Code	Stok Stock	Takım Ölçüleri (mm) Dimension (mm)							Kesici Uç Insert	Yedek Parçaları Spare Parts	
		D	R	d ₁	M	L	a	d ₂		Sıkma Vidası Screw	Tork Anahtar Torx Key
APMR-XP16-D16-M08-L25	●	16	8	14.75	M08	25	16	8.5			
APMR-XP20-D20-M10-L30	●	20	10	18	M10	30	20	10.5	XPHT 20R10T3	3008-M2.5x6	80-T08
APMR-XP25-D25-M12-L40	●	25	12.5	22	M12	40	25	12.5	XPHT 25R1204	1510-M3.5x9	80-T10
										1515-M4x9	80-T15

ZCC Ucuna Uygundur. / Compatible with ZCC Insert.

➤ VİDALI TAKIM TUTUCULARI
SCREWED TOOL HOLDERS

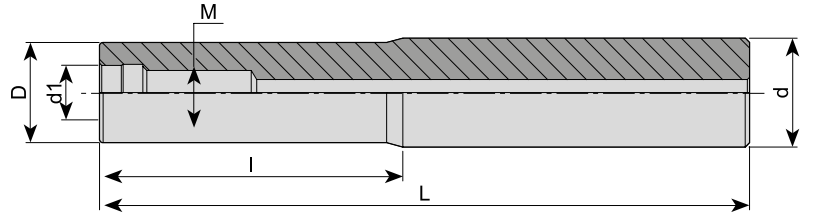

Takım Kodu Ordering Code	Stok Stock	Takım Ölçüleri (mm) Dimension (mm)					
		d	M	d ₁	D	L	I
AVTT-D13-C16-M08-L100-H	●	16	M08	8.5	13	100	40
AVTT-D15-C16-M08-L130-H	●	16	M08	8.5	15	130	70
AVTT-D18-C20-M10-L130-H	●	20	M10	10.5	18	130	70
AVTT-D18-C20-M10-L160-H	●	20	M10	10.5	18	160	80
AVTT-D23-C25-M12-L150-H	●	25	M12	12.5	23	150	70
AVTT-D23-C25-M12-L200-H	●	25	M12	12.5	23	200	100
AVTT-D23-C25-M12-L250-H	●	25	M12	12.5	23	250	150
AVTT-D30-C32-M16-L150-H	●	32	M16	17	30	150	70
AVTT-D30-C32-M16-L200-H	●	32	M16	17	30	200	100
AVTT-D30-C32-M16-L250-H	●	32	M16	17	30	250	150
AVTT-D30-C32-M16-L300-H	●	32	M16	17	30	300	200

R: Sağ/Right L: Sol/Left ● Stokta/In Stock ○ Stokta Yok/Non Stock Item

Sipariş Örneği/Ordering Example : 1 ad./pcs. APMR-XP16-D16-M08-L25
Kesme Hesabı : S 271 / Cutting Calculation : P 271



www.akkо.com.tr

Дистрибьютер ООО "Ресурс Плюс"
+7 (351) 247-74-40; info@rp-ural.ru

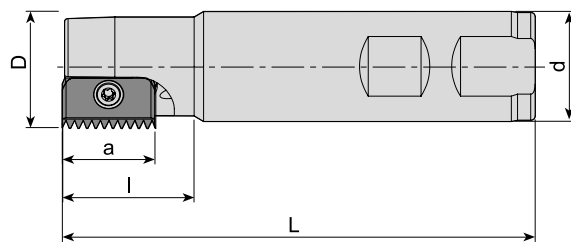

Takım Kodu Ordering Code	Stok Stock	Takım Ölçüleri (mm) Dimension (mm)						Kesici Uç Insert	Yedek Parçaları Spare Parts	
		D	Z	d	L	l	a		Sıkma Vidası Screw	Tork Anahtar Torx Key
ATM-C14-D14-W20-L100-Z01-H	●	14	1	20	100	25	14	C14	3008-M2.5x6	80-T08
ATM-C21-D18-W20-L100-Z01-H	●	18	1	20	100	30	21		1515-M4x9	
ATM-C21-D21-W25-L125-Z01-H	●	21	1	25	125	40	21	C21	1515-M4x11	80-T15
ATM-C21-D25-W20-L125-Z01-H	●	25	1	20	125	30	21			
ATM-C21-D28-W25-L90-Z01-H	●	28	1	25	90	30	21			
ATM-C21-D38-W32-L120-Z03-H	●	38	3	32	120	30	21			
ATM-C21-D43-W32-L90-Z03-H	●	43	3	32	90	30	21			
ATM-C30-D29-W25-L150-Z01-H	●	29	1	25	150	50	30	C30	1020-M5x14	80-T20

CPT Ucuna Uygundur. / Compatible with CPT Insert.

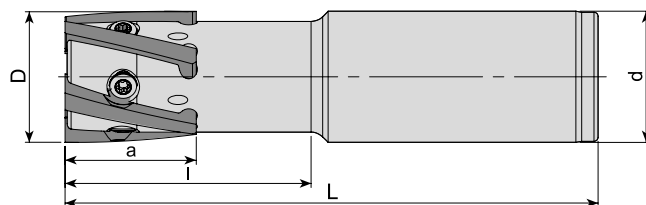

Takım Kodu Ordering Code	Stok Stock	Takım Ölçüleri (mm) Dimension (mm)						Kesici Uç Insert	Yedek Parçaları Spare Parts	
		D	Z	d	L	l	a		Sıkma Vidası Screw	Tork Anahtar Torx Key
ATM-H23-D23-C25-L100-Z02-H	●	23	2	25	100	30	27	H23	1015-M4x8	80-T15
ATM-H32-D32-C32-L130-Z05-H	●	32	5	32	130	35	32	H32	1720-U8-32x10	80-T20

R: Sağ/Right L: Sol/Left ● Stokta/In Stock ○ Stokta Yok/Non Stock Item
CPT Ucuna Uygundur. / Compatible with CPT Insert.

Sipariş Örneği/Ordering Example : 1 ad./pcs. ATM-C14-D14-W20-L100-Z01-H
Kesme Hesabı : S 271 / Cutting Calculation : P 271

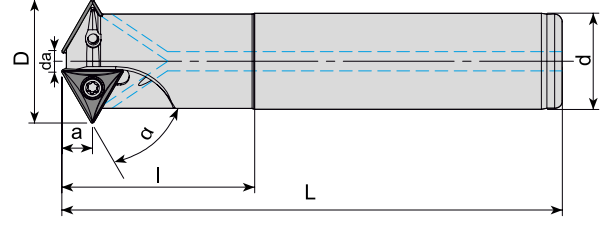

Takım Kodu Ordering Code	Stok Stock	Takım Ölçüleri (mm) Dimension (mm)								Kesici Uç Insert	Yedek Parçaları Spare Parts	
		α	D	d	da	L	l	Z	a		Sıkma Vidası Screw	Tork Anahtar Torx Key
ATM60-TB0601-D13-C10-L150-Z02-H	●	60	13	10	2.5	150	40	2	3.3			
ATM60-TC0902-D20.5-C16-L150-Z02-H	●	60	20.5	16	5.2	150	40	2	4.7	TBGT 060102	3006-M2x4	80-T06
ATM60-TC1102-D26-C20-L150-Z03-H	●	60	26	20	8.3	150	50	3	5.4	TC.T 090202	3007-M2.2x5	80-T07
ATM60-TC16T3-D32-C25-L150-Z02-H	●	60	32	25	6.4	150	50	2	8	TC.T 110202	3008-M2.5x6	80-T08
ATM60-TC16T3-D40-C32-L250-Z03-H	●	60	40	32	13.7	250	50	3	8	TC.T 16T304	4015-M3.5x9	80-T15

R: Sağ/Right L: Sol/Left ● Stokta/In Stock ○ Stokta Yok/Non Stock Item
ISO Ucuna Uygun. / Compatible with ISO Insert.

Sipariş Örneği/Ordering Example : 1 ad./pcs. ATM60-TB0601-D13-C10-L150-Z02-H
Kesme Hesabı : S 271 / Cutting Calculation : P 271



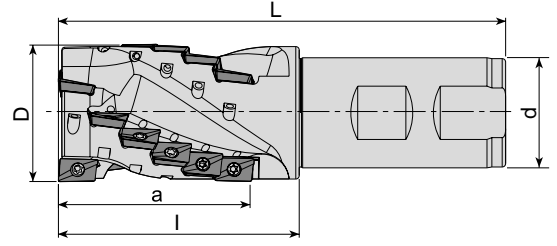

Takım Kodu Ordering Code	Stok Stock	Takım Ölçüleri (mm) Dimension (mm)							Kesici Uç Insert	Yedek Parçaları Spare Parts	
		Z		D	d	a	l	L		Sıkma Vidası Screw	Tork Anahtar Torx Key
		Toplam Total	Etkili Effective								
AHM90-AP10-D20-W20-L087-Z0204	●	4	2	20	20	28	37	87	AP.. 1003..	3008-M2.5x6	80-T08
AHM90-AP10-D20-W20-L087-Z0206	●	6	2	20	20	28	37	87			
AHM90-AP10-D25-W25-L105-Z0208-H	●	8	2	25	25	37	47	105			
AHM90-AP10-D32-W32-L115-Z0315-H	●	15	3	32	32	46	55	115			
AHM90-AP10-D40-W32-L130-Z0318-H	●	18	3	40	32	55	64	130			

R: Sağ/Right L: Sol/Left ● Stokta/In Stock ○ Stokta Yok/Non Stock Item
ISO Ucuna Uygun. / Compatible with ISO Insert.

Sipariş Örneği/Ordering Example : 1 ad./pcs. AHM90-AP10-D20-W20-L087-Z0204
Kesme Hesabı : S 271 / Cutting Calculation : P 271



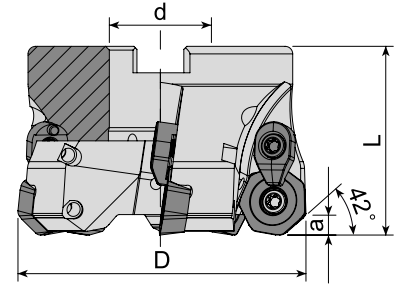

Takım Kodu Ordering Code	Stok Stock	Takım Ölçüleri (mm) Dimension (mm)					Kesici Uç Insert	Yedek Parçaları Spare Parts					
		D	Z	d	L	a		Sıkma Vidası Screw	Baskı Parçası Wedge Clamp	Baskı Vidası Clamp Screw	Tork Anahtar Torx Key	Montaj Vidası Mounting Screw	
AFM42C-XD0806-D063-A27-Z04-H	●	63	4	27	50	12	XDMW 0806..	4020-M4.5x12	ACK-24	4020-M4.5x12	80-T20	2510-M12x35	
AFM42C-XD0806-D080-A27-Z05-H	●	80	5	27	50	12							
AFM42C-XD0806-D100-A32-Z06-H	●	100	6	32	63	12							2514-M16x35
AFM42C-XD0806-D125-B40-Z07	●	125	7	40	63	12							-
AFM42C-XD0806-D160-C40-Z08	●	160	8	40	63	12							-
AFM42C-XD0806-D200-C60-Z09	●	200	9	60	63	12							-

DJT Ucuna Uygunudur. / Compatible with DJT Insert.

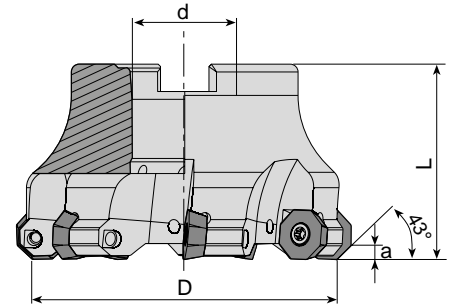

Takım Kodu Ordering Code	Stok Stock	Takım Ölçüleri (mm) Dimension (mm)					Kesici Uç Insert	Yedek Parçaları Spare Parts			
		D	Z	d	L	a		Sıkma Vidası Screw	Tork Anahtar Torx Key	Montaj Vidası Mounting Screw	
AFM43-OD0504-D040-A16-Z04-H	●	40	4	16	40	3.5	OD.. 0504..	4015-M3.5x11	80-T15	2506-M8x30	
AFM43-OD0504-D050-A22-Z05-H	●	50	5	22	40	3.5					
AFM43-OD0504-D063-A22-Z06-H	●	63	6	22	40	3.5					2407-M10x30
AFM43-OD0504-D080-A27-Z07-H	●	80	7	27	50	3.5					2510-M12x35
AFM43-OD0504-D100-A32-Z08-H	●	100	8	32	50	3.5					2514-M16x35

R: Sağ/Right L: Sol/Left ● Stokta/In Stock ○ Stokta Yok/Non Stock Item
WLTR Ucuna Uygunudur. / Compatible with WLTR Insert.

Sipariş Örneği/Ordering Example : 1 ad./pcs. AFM42C-XD0806-D063-A27-Z04-H
Kesme Hesabı : S 271 / Cutting Calculation : P 271
Montaj Ölçüleri : S 269 / Mounting Reference : P 269

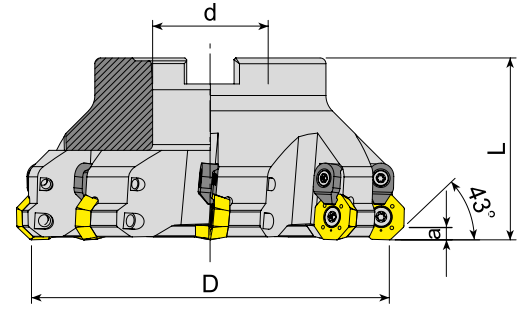

Takım Kodu Ordering Code	Stok Stock	Takım Ölçüleri (mm) Dimension (mm)					Kesici Uç Insert	Yedek Parçaları Spare Parts								
		D	Z	d	L	a		Sıkma Vidası Screw	Baskı Parçası Wedge Clamp	Baskı Vidası Clamp Screw	Tork Anahtar Torx Key	Montaj Vidası Mounting Screw				
AFM43C-OD0605-D080-A27-Z06-H	●	80	6	27	50	4	OD.. 0605..					2510-M12x35				
AFM43C-OD0605-D100-A32-Z07-H	●	100	7	32	50	4						1020-M5x11	ACK-05	1515-M4x11	80-T20	2514-M16x35
AFM43C-OD0605-D125-B40-Z08	●	125	8	40	63	4						-	-	-	-	-

WLTR-LMN Ucuna Uygunudur. / Compatible with WLTR-LMN Insert.

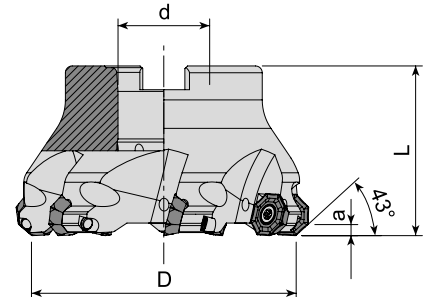

Takım Kodu Ordering Code	Stok Stock	Takım Ölçüleri (mm) Dimension (mm)					Kesici Uç Insert	Yedek Parçaları Spare Parts					
		D	Z	d	L	a		Sıkma Vidası Screw	Tork Anahtar Torx Key	Montaj Vidası Mounting Screw			
AFM43-OF05T3-D050-A22-Z05-H	●	50	5	22	40	3	OF.. 05T3..				1515-M4x9		
AFM43-OF05T3-D063-A22-Z06-H	●	63	6	22	40	3					2407-M10x30		
AFM43-OF05T3-D080-A27-Z07-H	●	80	7	27	50	3					1515-M4x11	80-T15	2510-M12x35
AFM43-OF05T3-D125-B40-Z09	●	125	9	40	63	3					-	-	-

R: Sağ/Right L: Sol/Left ● Stokta/In Stock ○ Stokta Yok/Non Stock Item
ISO Ucuna Uygunudur. / Compatible with ISO Insert.

Sipariş Örneği/Ordering Example : 1 ad./pcs. AFM43C-OD0605-D080-A27-Z06-H
Kesme Hesabı : S 271 / Cutting Calculation : P 271
Montaj Ölçüleri : S 269 / Mounting Reference : P 269

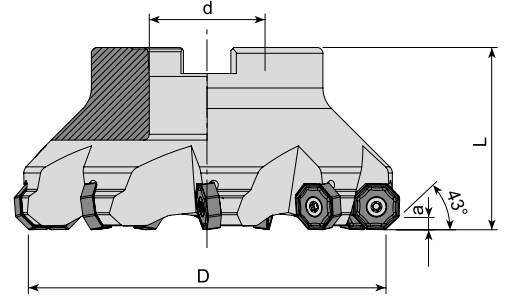

Takım Kodu Ordering Code	Stok Stock	Takım Ölçüleri (mm) Dimension (mm)					Kesici Uç Insert	Yedek Parçaları Spare Parts		
		D	Z	d	L	a		Sıkma Vidası Screw	Tork Anahtar Torx Key	Montaj Vidası Mounting Screw
AFM43-ON0604-D050-A22-Z05-H	●	50	5	22	40	4	ON.. 0604..	1515-M4x11	80-T15	2407-M10x30 2510-M12x35 2514-M16x35 -
AFM43-ON0604-D063-A22-Z06-H	●	63	6	22	40	4				
AFM43-ON0604-D080-A27-Z07-H	●	80	7	27	50	4				
AFM43-ON0604-D100-A32-Z08-H	●	100	8	32	50	4				
AFM43-ON0604-D125-B40-Z09	●	125	9	40	63	4				

ZCC Ucuna Uygunur. / Compatiple with ZCC Insert.

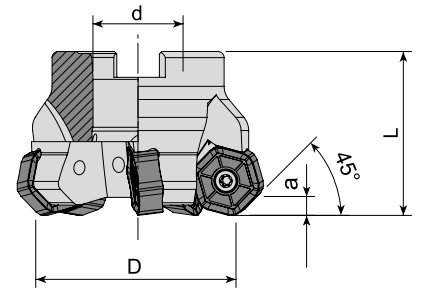

Takım Kodu Ordering Code	Stok Stock	Takım Ölçüleri (mm) Dimension (mm)					Kesici Uç Insert	Yedek Parçaları Spare Parts		
		D	Z	d	L	a		Sıkma Vidası Screw	Tork Anahtar Torx Key	Montaj Vidası Mounting Screw
AFM45-HN0905-D050-A22-Z05-H	●	50	5	22	40	4.5	HN.. 0905..	1515-M4x11	80-T15	2407-M10x30 2510-M12x35 -
AFM45-HN0905-D063-A22-Z06-H	●	63	6	22	40	4.5				
AFM45-HN0905-D080-A27-Z07-H	●	80	7	27	50	4.5				
AFM45-HN0905-D125-B40-Z10	●	125	10	40	63	4.5				
AFM45-HN0905-D160-C40-Z12	●	160	12	40	63	4.5				
AFM45L-HN0905-D160-C40-Z12	●	160	12	40	63	4.5				
AFM45L-HN0905-D200-C60-Z16	●	200	16	60	63	4.5				

R: Sağ/Right L: Sol/Left ● Stokta/In Stock ○ Stokta Yok/Non Stock Item
WDA Ucuna Uygunur. / Compatiple with WDA Insert.

Sipariş Örneği/Ordering Example : 1 ad./pcs. AFM43-ON0604-D050-A22-Z05-H
Kesme Hesabı : S 271 / Cutting Calculation : P 271
Montaj Ölçüleri : S 269 / Mounting Reference : P 269

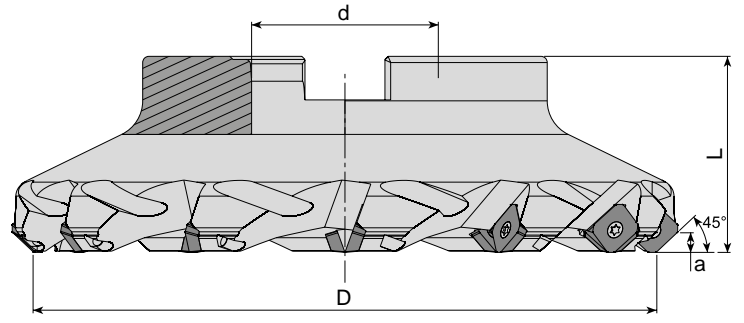

Takım Kodu Ordering Code	Stok Stock	Takım Ölçüleri (mm) Dimension (mm)					Kesici Uç Insert	Yedek Parçaları Spare Parts		
		D	Z	d	L	a		Sıkma Vidası Screw	Tork Anahtar Torx Key	Montaj Vidası Mounting Screw
AFM45-SE12-D050-A22-Z04-H	●	50	4	22	40	6	SE.. 12T3.. R245-12T3..	4015-M3.5x11	80-T15	2407-M10x30
AFM45L-SE12-D050-A22-Z04-H	●	50	4	22	40	6				
AFM45-SE12-D063-A22-Z05-H	●	63	5	22	40	6				
AFM45L-SE12-D063-A22-Z05-H	●	63	5	22	40	6				
AFM45-SE12-D080-A27-Z06-H	●	80	6	27	50	6				2510-M12x35
AFM45L-SE12-D080-A27-Z06-H	●	80	6	27	50	6				2514-M16x35
AFM45-SE12-D100-A32-Z07-H	●	100	7	32	50	6				-
AFM45-SE12-D125-B40-Z08	●	125	8	40	63	6				-
AFM45-SE12-D160-C40-Z10	●	160	10	40	63	6				-
AFM45-SE12-D200-C60-Z12	●	200	12	60	63	6				-

ZCC-SNDVK Ucuna Uygundur. / Compatible with ZCC-SNDVK Insert.

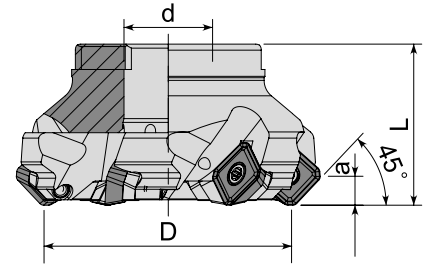

Takım Kodu Ordering Code	Stok Stock	Takım Ölçüleri (mm) Dimension (mm)					Kesici Uç Insert	Yedek Parçaları Spare Parts					
		D	Z	d	L	a		Altık Screw	Altık Vidası Wedge Clamp	Sıkma Vidası Screw	Tork Anahtar Torx Key	Montaj Vidası Mounting Screw	
AFM45-SE13-D050-A22-Z04-H	●	50	4	22	40	6	SEMT 13T3..	AASE-3-0001	AAV-16-M3.5x8	4015-M3.5x12	80-T15	2407-M10x30	
AFM45-SE13-D063-A22-Z05-H	●	63	5	22	40	6							
AFM45-SE13-D080-A27-Z06-H	●	80	6	27	50	6							2510-M12x35
AFM45S-SE13-D050-A22-Z05-H	●	50	5	22	40	6							2407-M10x30
AFM45S-SE13-D063-A22-Z06-H	●	63	6	22	40	6						2510-M12x35	
AFM45S-SE13-D080-A27-Z08-H	●	80	8	27	50	6						2514-M16x35	
AFM45S-SE13-D100-A32-Z10-H	●	100	10	32	50	6						-	
AFM45S-SE13-D125-B40-Z12	●	125	12	40	63	6						-	

R: Sağ/Right L: Sol/Left ● Stokta/In Stock ○ Stokta Yok/Non Stock Item
SMTM-DJT Ucuna Uygundur. / Compatible with SMTM-DJT Insert.

Sipariş Örneği/Ordering Example : 1 ad./pcs. AFM45-SE12-D050-A22-Z04-H
Kesme Hesabı : S 271 / Cutting Calculation : P 271
Montaj Ölçüleri : S 269 / Mounting Reference : P 269

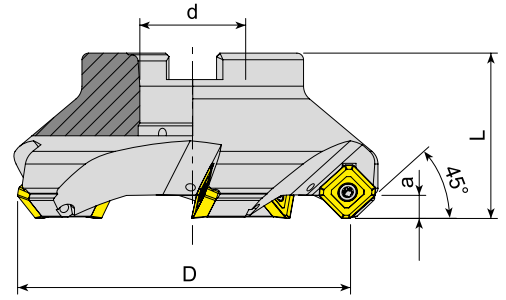

Takım Kodu Ordering Code	Stok Stock	Takım Ölçüleri (mm) Dimension (mm)					Kesici Uç Insert	Yedek Parçaları Spare Parts			
		D	Z	d	L	a		Sıkma Vidası Screw	Tork Anahtar Torx Key	Montaj Vidası Mounting Screw	
AFM45-SE14M4-D063-A22-Z04-H	●	63	4	22	40	7	SE.. 14M4..	4015-M3.5x11	80-T15	2407-M10x30	
AFM45-SE14M4-D080-A27-Z05-H	●	80	5	27	50	7				2510-M12x35	
AFM45-SE14M4-D100-A32-Z05-H	●	100	5	32	50	7				2514-M16x35	
AFM45-SE14M4-D125-B40-Z06	●	125	6	40	63	7				-	
AFM45-SE14M4-D160-C40-Z07	●	160	7	40	63	7				-	

KRLY Ucuna Uygundur. / Compatiple with KRLY Insert.

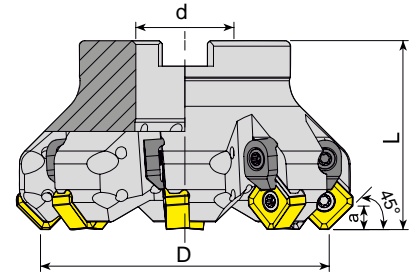

Takım Kodu Ordering Code	Stok Stock	Takım Ölçüleri (mm) Dimension (mm)					Kesici Uç Insert	Yedek Parçaları Spare Parts				
		D	Z	d	L	a		Sıkma Vidası Screw	Baskı Parçası Wedge Clamp	Baskı Vidası Clamp Screw	Tork Anahtar Torx Key	Montaj Vidası Mounting Screw
AFM45C-SN12..-D050-A22-Z04-H	●	50	4	22	42	6	SN.. 1206..	1015-M4x11	ACK-05	4015-M4x11	80-T15	2407-M10x30
AFM45C-SN12..-D050-A22-Z05-H	●	50	5	22	42	6						2510-M12x35
AFM45C-SN12..-D063-A22-Z06-H	●	63	6	22	42	6						2514-M16x35
AFM45C-SN12..-D063-A22-Z07-H	●	63	7	22	42	6						-
AFM45CL-SN12..-D063-A22-Z07-H	●	63	7	22	42	6						-
AFM45C-SN12..-D080-A27-Z07-H	●	80	7	27	52	6						-
AFM45C-SN12..-D080-A27-Z08-H	●	80	8	27	52	6						-
AFM45CL-SN12..-D080-A27-Z08-H	●	80	8	27	52	6						-
AFM45C-SN12..-D100-A32-Z08-H	●	100	8	32	52	6						-
AFM45C-SN12..-D100-A32-Z10-H	●	100	10	32	52	6						-
AFM45CL-SN12..-D100-A32-Z10-H	●	100	10	32	52	6						-
AFM45C-SN12..-D125-B40-Z11	●	125	11	40	65	6						-
AFM45CL-SN12..-D125-B40-Z11	●	125	11	40	65	6						-
AFM45C-SN12..-D160-C40-Z12	●	160	12	40	65	6						-
AFM45C-SN12..-D200-C60-Z14	●	200	14	60	65	6						-
AFM45CL-SN12..-D200-C60-Z14	●	200	14	60	65	6						-

R: Sağ/Right L: Sol/Left ● Stokta/In Stock ○ Stokta Yok/Non Stock Item

WLTR-LMN-ACHTK Ucuna Uygundur. / Compatiple with WLTR-LMN-ACHTK Insert.

Sipariş Örneği/Ordering Example : 1 ad./pcs. AFM45-SE14M4-D063-A22-Z04-H

Kesme Hesabı : S 271 / Cutting Calculation : P 271

Montaj Ölçüleri : S 269 / Mounting Reference : P 269



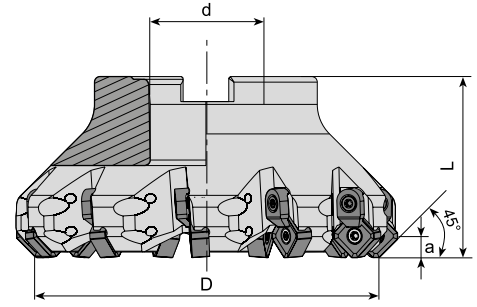

Takım Kodu Ordering Code	Stok Stock	Takım Ölçüleri (mm) Dimension (mm)					Kesici Uç Insert	Yedek Parçaları Spare Parts					
		D	Z	d	L	a		Sıkma Vidası Screw	Baskı Parçası Wedge Clamp	Baskı Vidası Clamp Screw	Tork Anahtar Torx Key	Montaj Vidası Mounting Screw	
AFM45C-SN1206-D050-A22-Z04-H	●	50	4	22	42	6	SN.. 1206..						
AFM45C-SN1206-D050-A22-Z05-H	●	50	5	22	42	6							
AFM45C-SN1206-D063-A22-Z06-H	●	63	6	22	42	6							2407-M10x30
AFM45C-SN1206-D063-A22-Z07-H	●	63	7	22	42	6							
AFM45CL-SN1206-D063-A22-Z07-H	●	63	7	22	42	6							
AFM45C-SN1206-D080-A27-Z07-H	●	80	7	27	52	6							
AFM45C-SN1206-D080-A27-Z08-H	●	80	8	27	52	6							2510-M12x35
AFM45CL-SN1206-D080-A27-Z08-H	●	80	8	27	52	6							
AFM45C-SN1206-D100-A32-Z08-H	●	100	8	32	52	6							
AFM45C-SN1206-D100-A32-Z10-H	●	100	10	32	52	6							2514-M16x35
AFM45CL-SN1206-D100-A32-Z10-H	●	100	10	32	52	6							
AFM45C-SN1206-D125-B40-Z11	●	125	11	40	65	6							
AFM45CL-SN1206-D125-B40-Z11	●	125	11	40	65	6							
AFM45C-SN1206-D160-C40-Z12	●	160	12	40	65	6							-
AFM45C-SN1206-D200-C60-Z14	●	200	14	60	65	6							
AFM45CL-SN1206-D200-C60-Z14	●	200	14	60	65	6							

KRLY-PLBT-BHLR Ucuna Uygundur. / Compatible with KRLY-PLBT-BHLR Insert.

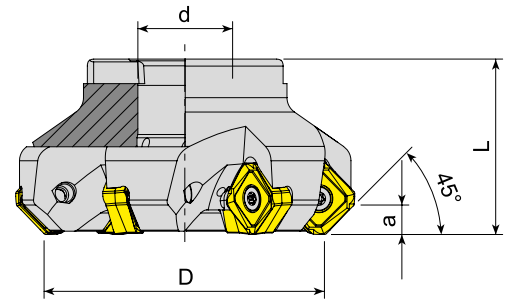

Takım Kodu Ordering Code	Stok Stock	Takım Ölçüleri (mm) Dimension (mm)					Kesici Uç Insert	Yedek Parçaları Spare Parts					
		D	Z	d	L	a		Sıkma Vidası Screw	Tork Anahtar Torx Key	Montaj Vidası Mounting Screw			
AFM45-SA1706-D080-A27-Z06-H	●	80	6	27	50	8.4	SAKU 1706..						
AFM45-SA1706-D100-A32-Z07-H	●	100	7	32	50	8.4					1020-M5x14	80-T20	2510-M12x35
AFM45-SA1706-D125-B40-Z09	●	125	9	40	63	8.4					-	-	2514-M16x35

R: Sağ/Right L: Sol/Left ● Stokta/In Stock ○ Stokta Yok/Non Stock Item
CRTZT Ucuna Uygundur. / Compatible with CRTZT Insert.

Sipariş Örneği/Ordering Example : 1 ad./pcs. AFM45C-SN1206-D050-A22-Z04-H
Kesme Hesabı : S 271 / Cutting Calculation : P 271
Montaj Ölçüleri : S 269 / Mounting Reference : P 269

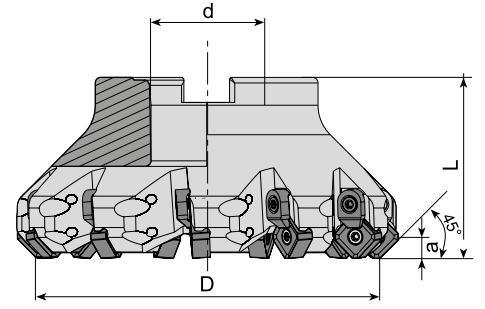

Takım Kodu Ordering Code	Stok Stock	Takım Ölçüleri (mm) Dimension (mm)					Kesici Uç Insert	Yedek Parçaları Spare Parts					
		D	Z	d	L	a		Sıkma Vidası Screw	Baskı Parçası Wedge Clamp	Baskı Vidası Clamp Screw	Tork Anahtar Torx Key	Montaj Vidası Mounting Screw	
AFM45C-SN12Z-D050-A22-Z05-H	●	50	5	22	42	6	SNEG 1205..						2407-M10X30
AFM45C-SN12Z-D063-A22-Z06-H	●	63	6	22	42	6							2510-M12x35
AFM45C-SN12Z-D080-A27-Z07-H	●	80	7	27	52	6							2514-M16x35
AFM45C-SN12Z-D100-A32-Z09-H	●	100	9	32	52	6							-
AFM45C-SN12Z-D125-B40-Z11	●	125	11	40	65	6							-
AFM45C-SN12Z-D160-C40-Z12	●	160	12	60	65	6							-
AFM45C-SN12Z-D200-C60-Z14	●	200	14	60	65	6							-

ZCC Ucuna Uygundur. / Compatible with ZCC Insert.

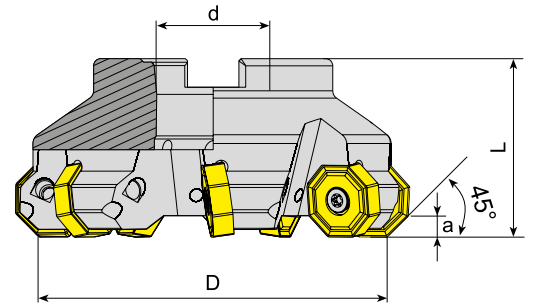

Takım Kodu Ordering Code	Stok Stock	Takım Ölçüleri (mm) Dimension (mm)					Kesici Uç Insert	Yedek Parçaları Spare Parts			
		D	Z	d	L	a		Sıkma Vidası Screw	Tork Anahtar Torx Key	Montaj Vidası Mounting Screw	
AFM45-ON0806-D063-A22-Z05-H	●	63	5	22	40	4					2508-M10x30
AFM45-ON0806-D080-A27-Z06-H	●	80	6	27	50	4					2510-M12x35
AFM45-ON0806-D100-A32-Z07-H	●	100	7	32	50	4					2514-M16x35
AFM45-ON0806-D125-B40-Z08	●	125	8	40	63	4					-
AFM45-ON0806-D160-C40-Z10	●	160	10	40	63	4					-
AFM45-ON0806-D200-C60-Z12	●	200	12	60	63	4					-
AFM45-ON0806-D315-D60-Z16	●	315	16	60	63	4					-

R: Sağ/Right L: Sol/Left ● Stokta/In Stock ○ Stokta Yok/Non Stock Item
ISO Ucuna Uygundur. / Compatible with ISO Insert.

Sipariş Örneği/Ordering Example : 1 ad./pcs. AFM45C-SN12Z-D050-A22-Z05-H
Kesme Hesabı : S 271 / Cutting Calculation : P 271
Montaj Ölçüleri : S 269 / Mounting Reference : P 269

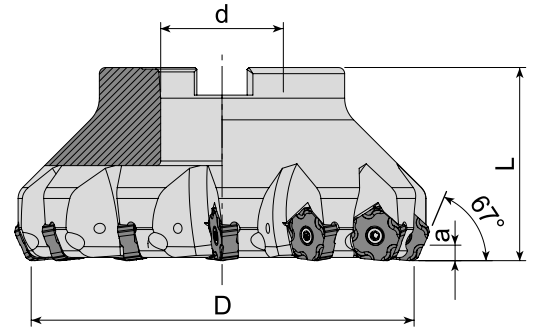

Takım Kodu Ordering Code	Stok Stock	Takım Ölçüleri (mm) Dimension (mm)					Kesici Uç Insert	Yedek Parçaları Spare Parts			
		D	Z	d	L	a		Sıkma Vidası Screw	Tork Anahtar Torx Key	Montaj Vidası Mounting Screw	
AFM67-PN1105-D050-A22-Z05	●	50	5	22	50	5	PNEG 1105..				
AFM67-PN1105-D063-A22-Z06	●	63	6	22	50	5					2508-M10x30
AFM67-PN1105-D080-A27-Z08	●	80	8	27	50	5					2510-M12x35
AFM67-PN1105-D100-B32-Z10	●	100	10	32	50	5					-
AFM67-PN1105-D125-B40-Z12	●	125	12	40	63	5					-
AFM67-PN1105-D160-C40-Z14	●	160	14	40	63	5					-

ZCC Ucuna Uygunudur. / Compatible with ZCC Insert.

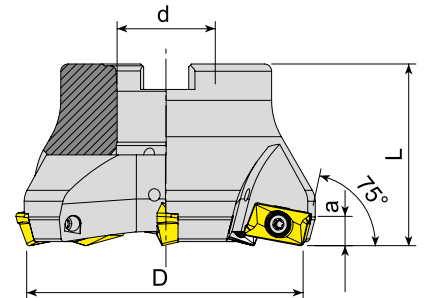

Takım Kodu Ordering Code	Stok Stock	Takım Ölçüleri (mm) Dimension (mm)					Kesici Uç Insert	Yedek Parçaları Spare Parts			
		D	Z	d	L	a		Sıkma Vidası Screw	Tork Anahtar Torx Key	Montaj Vidası Mounting Screw	
AFM75-AP16-D063-A22-Z04-H	●	63	4	22	40	6	AP.. 1604..				
AFM75-AP16-D080-A27-Z05-H	●	80	5	27	50	6					2508-M10x30
AFM75-AP16-D100-A32-Z06-H	●	100	6	32	50	6					2510-M12x35
AFM75-AP16-D125-B40-Z07	●	125	7	40	63	6					2514-M16x35

R: Sağ/Right L: Sol/Left ● Stokta/In Stock ○ Stokta Yok/Non Stock Item
ISO Ucuna Uygunudur. / Compatible with ISO Insert.

Sipariş Örneği/Ordering Example : 1 ad./pcs. AFM67-PN1105-D050-A22-Z05
Kesme Hesabı : S 271 / Cutting Calculation : P 271
Montaj Ölçüleri : S 269 / Mounting Reference : P 269

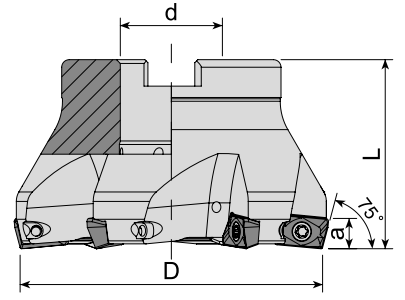

Takım Kodu Ordering Code	Stok Stock	Takım Ölçüleri (mm) Dimension (mm)					Kesici Uç Insert	Yedek Parçaları Spare Parts			
		D	Z	d	L	a		Sıkma Vidası Screw	Tork Anahtar Torx Key	Montaj Vidası Torx Key	
AFM75-X012-D050-A22-Z04-H	●	50	4	22	40	-	XOMX 1204..		1510-M3.5x9		2508-M10x30
AFM75-X012-D063-A22-Z05-H	●	63	5	22	40	-					
AFM75-X012-D080-A27-Z06-H	●	80	6	27	50	-					

SC Ucuna Uygun. / Compatible with SC Insert.

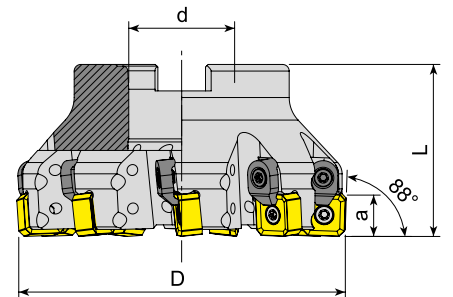

Takım Kodu Ordering Code	Stok Stock	Takım Ölçüleri (mm) Dimension (mm)					Kesici Uç Insert	Yedek Parçaları Spare Parts				
		D	Z	d	L	a		Sıkma Vidası Screw	Baskı Parçası Wedge Clamp	Baskı Vidası Clamp Screw	Tork Anahtar Torx Key	Montaj Vidası Mounting Screw
AFM88C-SN1206-D063-A22-Z06-H	●	63	6	22	40	11.5	SN.. 1206..					2508-M10x30
AFM88C-SN1206-D080-A27-Z07-H	●	80	7	27	50	11.5						
AFM88C-SN1206-D100-A32-Z09-H	●	100	9	32	52	11.5						

R: Sağ/Right L: Sol/Left ● Stokta/In Stock ○ Stokta Yok/Non Stock Item
ISO Ucuna Uygun. / Compatible with ISO Insert.

Sipariş Örneği/Ordering Example : 1 ad./pcs. AFM75-X012-D050-A22-Z04-H
Kesme Hesabı : S 271 / Cutting Calculation : P 271
Montaj Ölçüleri : S 269 / Mounting Reference : P 269



88°

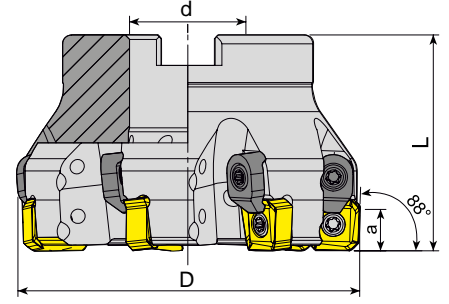

Takım Kodu Ordering Code	Stok Stock	Takım Ölçüleri (mm) Dimension (mm)					Kesici Uç Insert	Yedek Parçaları Spare Parts				
		D	Z	d	L	a		Sıkma Vidası Screw	Baskı Parçası Wedge Clamp	Baskı Vidası Clamp Screw	Tork Anahtar Torx Key	Montaj Vidası Mounting Screw
AFM88C-SN12Z-D063-A22-Z06-H	●	63	6	22	40	11.5	SNEG 1205..					
AFM88C-SN12Z-D080-A27-Z07-H	●	80	7	27	50	11.5						

ZCC Ucuna Uygundur. / Compatible with ZCC Insert.

90°

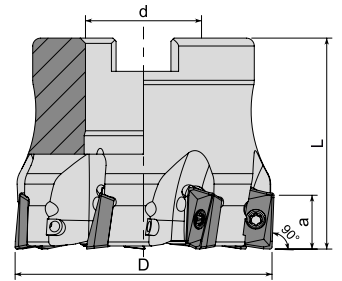

Takım Kodu Ordering Code	Stok Stock	Takım Ölçüleri (mm) Dimension (mm)					Kesici Uç Insert	Yedek Parçaları Spare Parts		
		D	Z	d	L	a		Sıkma Vidası Screw	Tork Anahtar Torx Key	Montaj Vidası Torx Key
AFM90-AD10T3-D040-A16-Z06-H	●	40	6	16	40	10				
AFM90-AD10T3-D050-A22-Z07-H	●	50	7	22	40	10				

R: Sağ/Right L: Sol/Left ● Stokta/In Stock ○ Stokta Yok/Non Stock Item
WLTR Ucuna Uygundur. / Compatible with WLTR Insert.

Sipariş Örneği/Ordering Example : 1 ad./pcs. AFM88C-SN12Z-D063-A22-Z06-H
Kesme Hesabı : S 271 / Cutting Calculation : P 271
Montaj Ölçüleri : S 269 / Mounting Reference : P 269

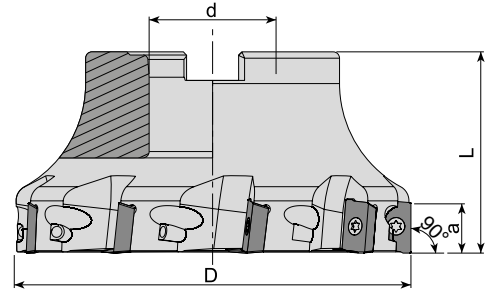

Takım Kodu Ordering Code	Stok Stock	Takım Ölçüleri (mm) Dimension (mm)					Kesici Uç Insert	Yedek Parçaları Spare Parts		
		D	Z	d	L	a		Sıkma Vidası Screw	Tork Anahtar Torx Key	Montaj Vidası Mounting Screw
AFM90-AD1505-D040-A16-Z04-H	●	40	4	16	40	15	AD.. 1505..	1515-M4x11	80-T15	2506-M8x30
AFM90-AD1505-D050-A22-Z05-H	●	50	5	22	40	15				2508-M10x30
AFM90-AD1505-D063-A22-Z06-H	●	63	6	22	40	15				2510-M12x35
AFM90-AD1505-D080-A27-Z07-H	●	80	7	27	50	15				2514-M16x35
AFM90-AD1505-D100-A32-Z08-H	●	100	8	32	50	15				-
AFM90-AD1505-D125-B40-Z09	●	125	9	40	63	15				-

ISCR Ucuna Uygunudur. / Compatible with ISCR Insert.

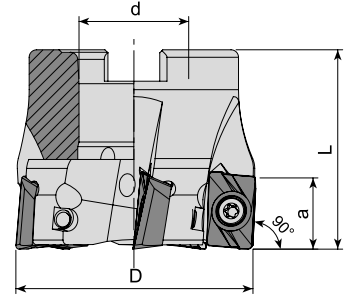

Takım Kodu Ordering Code	Stok Stock	Takım Ölçüleri (mm) Dimension (mm)					Kesici Uç Insert	Yedek Parçaları Spare Parts		
		D	Z	d	L	a		Sıkma Vidası Screw	Tork Anahtar Torx Key	Montaj Vidası Mounting Screw
AFM90-AD1505D-D050-A22-Z05-H	●	50	5	22	40	14.3	ADKT 150508	1515-M4x11	80-T15	2508-M10x30
AFM90-AD1505D-D063-A27-Z06-H	●	63	6	27	50	14.3				2510-M12x35
AFM90-AD1505D-D080-A27-Z08-H	●	80	8	27	50	14.3				-

R: Sağ/Right L: Sol/Left ● Stokta/In Stock ○ Stokta Yok/Non Stock Item
DJT Ucuna Uygunudur. / Compatible with DJT Insert.

Sipariş Örneği/Ordering Example : 1 ad./pcs. AFM90-AD1505-D040-A16-Z04-H
Kesme Hesabı : S 271 / Cutting Calculation : P 271
Montaj Ölçüleri : S 269 / Mounting Reference : P 269

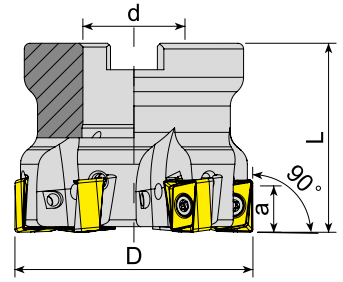

Takım Kodu Ordering Code	Stok Stock	Takım Ölçüleri (mm) Dimension (mm)					Kesici Uç Insert	Yedek Parçaları Spare Parts		
		D	Z	d	L	a		Sıkma Vidası Screw	Tork Anahtar Torx Key	Montaj Vidası Torx Key
AFM90-AN12-D040-A16-Z04-H	●	40	4	16	40	12	ANKX 1205..	4015-M4x12	80-T15	2406-M8x30
AFM90-AN12-D050-A22-Z05-H	●	50	5	22	40	12				2508-M10x30
AFM90-AN12-D063-A27-Z06-H	●	63	6	27	50	12				2510-M12x35

ISCR Ucuna Uygundur. / Compatible with ISCR Insert.

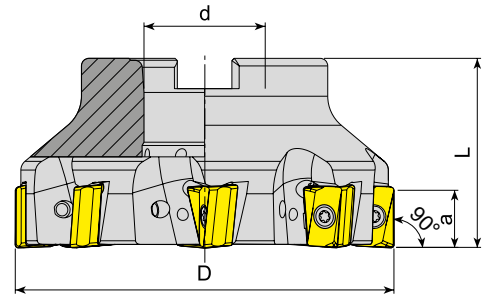

Takım Kodu Ordering Code	Stok Stock	Takım Ölçüleri (mm) Dimension (mm)					Kesici Uç Insert	Yedek Parçaları Spare Parts		
		D	Z	d	L	a		Sıkma Vidası Screw	Tork Anahtar Torx Key	Montaj Vidası Mounting Screw
AFM90-AN1607-D050-A22-Z04-H	●	50	4	22	40	15	AN.X 1607..	1515-M4x11	80-T15	2508-M10x30
AFM90-AN1607-D063-A22-Z06-H	●	63	6	22	40	15				2510-M12x35
AFM90-AN1607-D080-A27-Z07-H	●	80	7	27	50	15				2514-M16x35
AFM90-AN1607-D100-A32-Z08-H	●	100	8	32	50	15				

R: Sağ/Right L: Sol/Left ● Stokta/In Stock ○ Stokta Yok/Non Stock Item
TGTC Ucuna Uygundur. / Compatible with TGTC Insert.

Sipariş Örneği/Ordering Example : 1 ad./pcs. AFM90-AN12-D040-A16-Z04-H
Kesme Hesabı : S 271 / Cutting Calculation : P 271
Montaj Ölçüleri : S 269 / Mounting Reference : P 269

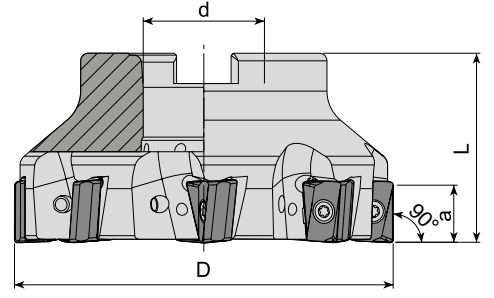

Takım Kodu Ordering Code	Stok Stock	Takım Ölçüleri (mm) Dimension (mm)					Kesici Uç Insert	Yedek Parçaları Spare Parts		
		D	Z	d	L	a		Sıkma Vidası Screw	Tork Anahtar Torx Key	Montaj Vidası Mounting Screw
AFM90-AN11-D040-A16-Z04-H	●	40	4	16	40	11	ANGX 1105..	4010-M3x8	80-T10	2506-M8x30
AFM90-AN1506-D050-A22-Z04-H	●	50	4	22	40	14.5	ANGX 1506..	4015-M4x12	80-T15	2508-M10x30
AFM90-AN1506-D063-A22-Z05-H	●	63	5	22	40	14.5				2510-M12x35
AFM90-AN1506-D080-A27-Z06-H	●	80	6	27	50	14.5				2514-M16x35
AFM90-AN1506-D100-A32-Z08-H	●	100	8	32	50	14.5				-
AFM90-AN1506-D125-B40-Z09	●	125	9	40	63	14.5				-
AFM90-AN1506-D160-C40-Z10	●	160	10	40	63	14.5	-	-	-	-

ZCC Ucuna Uygunudur. / Compatiple with ZCC Insert.

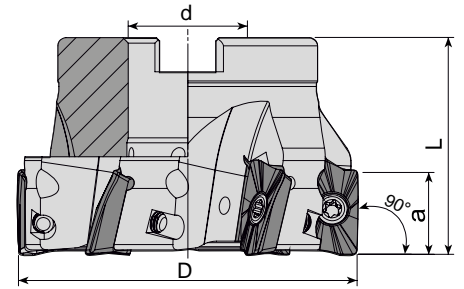

Takım Kodu Ordering Code	Stok Stock	Takım Ölçüleri (mm) Dimension (mm)					Kesici Uç Insert	Yedek Parçaları Spare Parts		
		D	Z	d	L	a		Sıkma Vidası Screw	Tork Anahtar Torx Key	Montaj Vidası Mounting Screw
AFM90-AO1236-D050-A22-Z05-H	●	50	5	22	40	12	AO.. 1236..	3008-M2.5x6	80-T08	2508-M10x30
AFM90-AO1848-D050-A22-Z05-H	●	50	5	22	40	15	AO.. 1848..	4015-M4x11	80-T15	2508-M10x30
AFM90-AO1848-D063-A22-Z06-H	●	63	6	22	40	15				

R: Sağ/Right L: Sol/Left ● Stokta/In Stock ○ Stokta Yok/Non Stock Item
MTSBH Ucuna Uygunudur. / Compatiple with MTSBH Insert.

Sipariş Örneği/Ordering Example : 1 ad./pcs. AFM90-AN11-D040-A16-Z04-H
Kesme Hesabı : S 271 / Cutting Calculation : P 271
Montaj Ölçüleri : S 269 / Mounting Reference : P 269

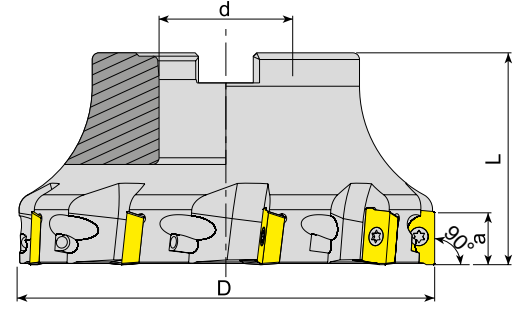

Takım Kodu Ordering Code	Stok Stock	Takım Ölçüleri (mm) Dimension (mm)					Kesici Uç Insert	Yedek Parçaları Spare Parts		
		D	Z	d	L	a		Sıkma Vidası Screw	Tork Anahtar Torx Key	Montaj Vidası Mounting Screw
AFM90-AP10-D040-A16-Z05-H	●	40	5	16	40	10	AP.. 1003.. ISO UCUNA UYGUNDUR. FOR ISO INSERT.	3008-M2.5x6	80-T08	2506-M8x30
AFM90-AP10-D050-A22-Z06-H	●	50	6	22	40	10				2508-M10x30
AFM90-AP10-D063-A22-Z07-H	●	63	7	22	40	10				2510-M12x35
AFM90-AP10-D080-A27-Z08-H	●	80	8	27	50	10				2514-M16x35
AFM90-AP10-D100-A32-Z09-H	●	100	9	32	50	10				2506-M8x30
AFM90-AP16-D040-A16-Z04-H	●	40	4	16	40	16	AP.. 1604.. ISO UCUNA UYGUNDUR. FOR ISO INSERT.			2508-M10x30
AFM90-AP16-D050-A22-Z05-H	●	50	5	22	40	16				2510-M12x35
AFM90-AP16-D052-A22-Z05-H	●	52	5	22	40	16				2514-M16x35
AFM90-AP16-D063-A22-Z06-H	●	63	6	22	40	16				-
AFM90-AP16-D080-A27-Z07-H	●	80	7	27	50	16				
AFM90-AP16-D100-A32-Z08-H	●	100	8	32	50	16				
AFM90-AP16-D125-B40-Z09	●	125	9	40	63	16				
AFM90-AP16-D160-C40-Z10	●	160	10	40	63	16				
AFM90-AP16-D200-C60-Z12	●	200	12	60	63	16				
AFM90-AP16DJ-D050-A22-Z05-H	●	50	5	22	40	16	AP.. 1604.. DJT UCUNA UYGUNDUR. FOR DJT INSERT.	1515-M4x11	80-T15	2508-M10x30
AFM90-AP16DJ-D063-A22-Z06-H	●	63	6	22	40	16				2510-M12x35
AFM90-AP16DJ-D080-A27-Z07-H	●	80	7	27	50	16				2508-M10x30
AFM90-AP16L-D050-A22-Z05-H	●	50	5	22	40	16	AP.. 1604.. LMN UCUNA UYGUNDUR. FOR LMN INSERT.			2510-M12x35
AFM90-AP16L-D063-A22-Z06-H	●	63	6	22	40	16				2508-M10x30
AFM90-AP16L-D080-A27-Z07-H	●	80	7	27	50	16				2510-M12x35
AFM90-AP16P-D040-A16-Z04-H	●	40	4	16	40	16	AP.. 1604.. PLBT UCUNA UYGUNDUR. FOR PLBT INSERT.			2506-M8x30
AFM90-AP16P-D050-A22-Z05-H	●	50	5	22	40	16				2508-M10x30
AFM90-AP16P-D063-A22-Z06-H	●	63	6	22	40	16				2510-M12x35
AFM90-AP16P-D080-A27-Z07-H	●	80	7	27	50	16				2514-M16x35
AFM90-AP16P-D100-A32-Z08-H	●	100	8	32	50	16				
AFM90-AP1705-D050-A22-Z05-H	●	50	5	22	40	16	AP.. 1705.. TGTC-LMN UCUNA UYGUNDUR. FOR TGTC-LMN INSERT.			2508-M10x30
AFM90-AP1705-D063-A22-Z06-H	●	63	6	22	40	16				2510-M12x35
AFM90-AP1705-D080-A27-Z07-H	●	80	7	27	50	16				2514-M16x35
AFM90-AP1705-D100-A32-Z08-H	●	100	8	32	50	16				

R: Sağ/Right L: Sol/Left ● Stokta/In Stock ○ Stokta Yok/Non Stock Item

Sipariş Örneği/Ordering Example : 1 ad./pcs. AFM90-AP10-D040-A16-Z05-H

Kesme Hesabı : S 271 / Cutting Calculation : P 271

Montaj Ölçüleri : S 269 / Mounting Reference : P 269

240 / 241

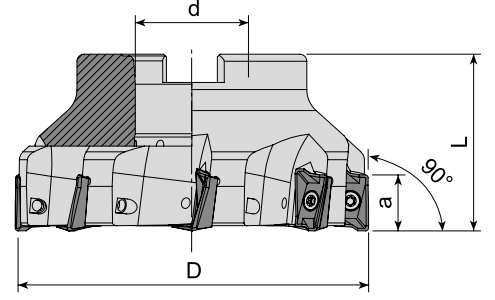

Takım Kodu Ordering Code	Stok Stock	Takım Ölçüleri (mm) Dimension (mm)					Kesici Uç Insert	Yedek Parçaları Spare Parts		
		D	Z	d	L	a		Sıkma Vidası Screw	Tork Anahtar Torx Key	Montaj Vidası Mounting Screw
AFM90-AX1235-D040-A16-Z06-H	●	40	6	16	40	10	AX.T 1235..	3108-M3x6	80-T08	2506-M8x30
AFM90-AX1235-D050-A22-Z07-H	●	50	7	22	40	10				2508-M10x30
AFM90-AX1235-D063-A22-Z08-H	●	63	8	22	40	10				2510-M12x35
AFM90-AX1235-D080-A27-Z10-H	●	80	10	27	50	10				2506-M8x30
AFM90-AX1705-D040-A16-Z04-H	●	40	4	16	40	14	AX.T 1705..	4015-M4x11	80-T15	2506-M8x30
AFM90-AX1705-D050-A22-Z05-H	●	50	5	22	40	14				2508-M10x30
AFM90-AX1705-D063-A22-Z06-H	●	63	6	22	40	14				2510-M12x35
AFM90-AX1705-D080-A27-Z07-H	●	80	7	27	50	14				2514-M16x35
AFM90-AX1705-D100-A32-Z08-H	●	100	8	32	50	14				

SMTM Ucuna Uygun. / Compatible with SMTM Insert.

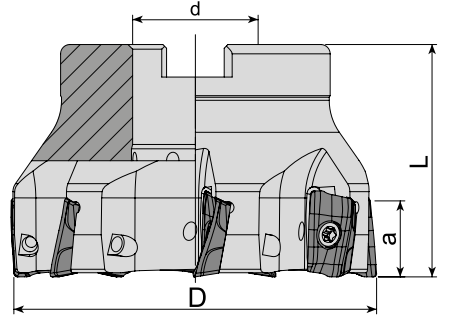

Takım Kodu Ordering Code	Stok Stock	Takım Ölçüleri (mm) Dimension (mm)					Kesici Uç Insert	Yedek Parçaları Spare Parts		
		D	Z	d	L	a		Sıkma Vidası Screw	Tork Anahtar Torx Key	Montaj Vidası Mounting Screw
AFM90-BD1704-D050-A22-Z05-H	●	50	5	22	40	15.7	BDMT 1704..	1515-M4x11	80-T15	2508-M10x30
AFM90-BD1704-D063-A22-Z06-H	●	63	6	22	40	15.7				2510-M12x35
AFM90-BD1704-D080-A27-Z07-H	●	80	7	27	50	15.7				

R: Sağ/Right L: Sol/Left ● Stokta/In Stock ○ Stokta Yok/Non Stock Item
KYCR Ucuna Uygun. / Compatible with KYCR Insert.

Sipariş Örneği/Ordering Example : 1 ad./pcs. AFM90-AX1235-D040-A16-Z06-H
Kesme Hesabı : S 271 / Cutting Calculation : P 271
Montaj Ölçüleri : S 269 / Mounting Reference : P 269

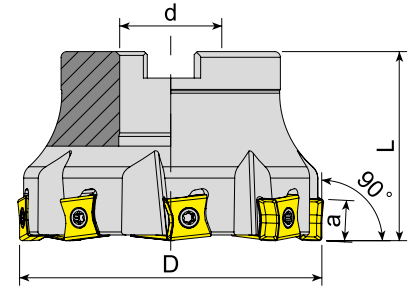

Takım Kodu Ordering Code	Stok Stock	Takım Ölçüleri (mm) Dimension (mm)					Kesici Uç Insert	Yedek Parçaları Spare Parts		
		D	Z	d	L	a		Sıkma Vidası Screw	Tork Anahtar Torx Key	Montaj Vidası Torx Key
AFM90-LN1106-D050-A22-Z05	●	50	5	22	40	10	LNMT 1106..	4015-M3.5x11	80-T15	2508-M10x30
AFM90-LN1106-D063-A22-Z06	●	63	6	22	40	10				2510-M12x35
AFM90-LN1106-D080-A27-Z08	●	80	8	27	50	10				2514-M16x35
AFM90L-LN1106-D080-A27-Z08	●	80	8	27	50	10				-
AFM90-LN1106-D100-A32-Z09	●	100	9	32	50	10				2506-M8x30
AFM90L-LN1106-D100-A32-Z09	●	100	9	32	50	10				2508-M10x30
AFM90-LN1106-D125-B40-Z10	●	125	10	40	63	10				2510-M12x35
AFM90-LN1306-D040-A16-Z04-H	●	40	4	16	40	12.5	LNMT 1306..	4015-M4x11	80-T15	2514-M16x35
AFM90-LN1306-D050-A22-Z05-H	●	50	5	22	40	12.5				2506-M8x30
AFM90-LN1306-D063-A22-Z06-H	●	63	6	22	40	12.5				2508-M10x30
AFM90-LN1306-D080-A27-Z07-H	●	80	7	27	50	12.5				2510-M12x35
AFM90-LN1306-D100-A32-Z08-H	●	100	8	32	50	12.5				2514-M16x35
AFM90L-LN1506-D040-A16-Z04	●	40	4	16	40	14	LNMT 1506..	4015-M4x9	80-T20	2506-M8x30
AFM90-LN1506-D040-A16-Z04	○	40	4	16	40	14				2508-M10x30
AFM90-LN1506-D050-A22-Z05	○	50	5	22	40	14				2510-M12x35
AFM90-LN1506-D063-A22-Z06	○	63	6	22	40	14				2514-M16x35
AFM90-LN1506-D080-A27-Z07	○	80	7	27	50	14				-
AFM90-LN1607-D050-A22-Z03-H	●	50	3	22	40	16	LNHT 1607..	4420-M5x14	80-T20	2508-M10x30
AFM90-LN1607-D063-A22-Z04	○	63	4	22	40	16				2510-M12x35
AFM90-LN1607-D080-A27-Z05	○	80	5	27	50	16				2514-M16x35
AFM90-LN1607-D100-A32-Z06-H	●	100	6	32	50	16				-

R: Sağ/Right L: Sol/Left ● Stokta/In Stock ○ Stokta Yok/Non Stock Item
ISCR Ucuna Uygunudur. / Compatible with ISCR Insert.

Sipariş Örneği/Ordering Example : 1 ad./pcs. AFM90-LN1106-D050-A22-Z05
Kesme Hesabı : S 271 / Cutting Calculation : P 271
Montaj Ölçüleri : S 269 / Mounting Reference : P 269

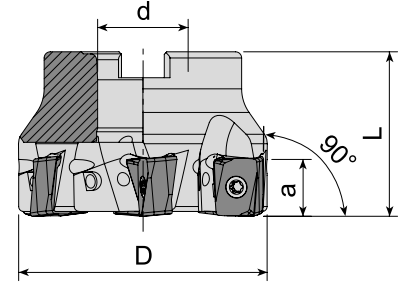

Takım Kodu Ordering Code	Stok Stock	Takım Ölçüleri (mm) Dimension (mm)					Kesici Uç Insert	Yedek Parçaları Spare Parts		
		D	Z	d	L	a		Sıkma Vidası Screw	Tork Anahtar Torx Key	Montaj Vidası Mounting Screw
AFM90-LN1307-D050-A22-Z04-H	●	50	4	22	40	13	LNKX 1307..	1315-M4x11	80-T15	2508-M10x30
AFM90-LN1307-D063-A22-Z06-H	●	63	6	22	40	13				2510-M12x35
AFM90-LN1307-D080-A27-Z07-H	●	80	7	27	50	13				2514-M16x35
AFM90-LN1307-D100-A32-Z08-H	●	100	8	32	50	13				-

WLTR Ucuna Uygunudur. / Compatible with WLTR Insert.

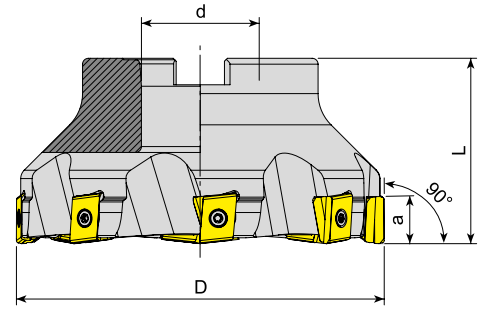

Takım Kodu Ordering Code	Stok Stock	Takım Ölçüleri (mm) Dimension (mm)					Kesici Uç Insert	Yedek Parçaları Spare Parts		
		D	Z	d	L	a		Sıkma Vidası Screw	Tork Anahtar Torx Key	Montaj Vidası Mounting Screw
AFM90-LN15Z-D050-A22-Z04	●	50	4	22	40	15	LNKT 1506..	1515-M4x11	80-T15	2508-M10x30
AFM90-LN15Z-D063-A22-Z05	●	63	5	22	40	15				2510-M12x35
AFM90-LN15Z-D080-A27-Z06	●	80	6	27	50	15				2514-M16x35
AFM90-LN15Z-D100-A32-Z07	●	100	7	32	50	15				-
AFM90-LN15Z-D125-B40-Z08	●	125	8	40	63	15				-

R: Sağ/Right L: Sol/Left ● Stokta/In Stock ○ Stokta Yok/Non Stock Item
ZCC Ucuna Uygunudur. / Compatible with ZCC Insert.

Sipariş Örneği/Ordering Example : 1 ad./pcs. AFM90-LN1307-D050-A22-Z04-H
Kesme Hesabı : S 271 / Cutting Calculation : P 271
Montaj Ölçüleri : S 269 / Mounting Reference : P 269

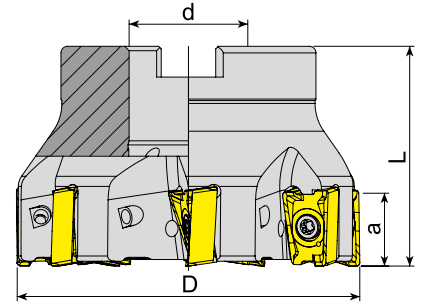

Takım Kodu Ordering Code	Stok Stock	Takım Ölçüleri (mm) Dimension (mm)					Kesici Uç Insert	Yedek Parçaları Spare Parts		
		D	Z	d	L	a		Sıkma Vidası Screw	Tork Anahtar Torx Key	Montaj Vidası Mounting Screw
AFM90-LN15T6-D050-A22-Z05-H	●	50	5	22	40	15.5	LNGU 15T6..	4015-M4x12	80-T15	2508-M10x30
AFM90-LN15T6-D063-A22-Z06-H	●	63	6	22	40	15.5				2510-M12x35
AFM90-LN15T6-D080-A27-Z07-H	●	80	7	27	50	15.5				

KNMTL Ucuna Uygunudur. / Compatiple with KNMTL Insert.

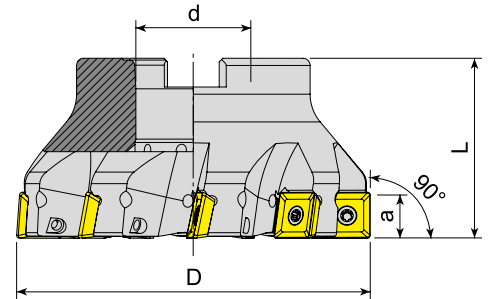

Takım Kodu Ordering Code	Stok Stock	Takım Ölçüleri (mm) Dimension (mm)					Kesici Uç Insert	Yedek Parçaları Spare Parts		
		D	Z	d	L	a		Sıkma Vidası Screw	Tork Anahtar Torx Key	Montaj Vidası Mounting Screw
AFM90-R290.12-D050-A22-Z04-H	●	50	4	22	40	10.7	R290-12T3..	4015-M3.5x11	80-T15	2508-M10x30
AFM90-R290.12-D063-A22-Z05-H	●	63	5	22	40	10.7				2510-M12x35
AFM90-R290.12-D080-A27-Z07-H	●	80	7	27	50	10.7				2514-M16x35
AFM90-R290.12-D100-A32-Z09-H	●	100	9	32	50	10.7				-
AFM90-R290.12-D125-B40-Z11	●	125	11	40	63	10.7				

R: Sağ/Right L: Sol/Left ● Stokta/In Stock ○ Stokta Yok/Non Stock Item
SNDVK Ucuna Uygunudur. / Compatiple with SNDVK Insert.

Sipariş Örneği/Ordering Example : 1 ad./pcs. AFM90-LN15T6-D050-A22-Z05-H
Kesme Hesabı : S 271 / Cutting Calculation : P 271
Montaj Ölçüleri : S 269 / Mounting Reference : P 269

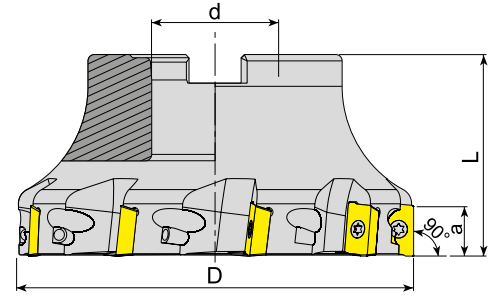

Takım Kodu Ordering Code	Stok Stock	Takım Ölçüleri (mm) Dimension (mm)					Kesici Uç Insert	Yedek Parçaları Spare Parts		
		D	Z	d	L	a		Sıkma Vidası Screw	Tork Anahtar Torx Key	Montaj Vidası Mounting Screw
AFM90-R390.11-D040-A16-Z05-H	●	40	5	16	40	10	R390-11T3..	3008-M2.5x6	80-T08	2506-M8x30
AFM90-R390.11-D050-A22-Z06-H	●	50	6	22	40	10				2508-M10x30
AFM90-R390.11-D063-A22-Z07-H	●	63	7	22	40	10				2510-M12x35
AFM90-R390.11-D080-A27-Z09-H	●	80	9	27	50	10				-
AFM90-R390.17-D040-A16-Z04-H	●	40	4	16	40	15.4	R390-1704..	4015-M3.5x11	80-T15	2506-M8x30
AFM90-R390.17-D050-A22-Z05-H	●	50	5	22	40	15.4				2508-M10x30
AFM90-R390.17-D063-A22-Z06-H	●	63	6	22	40	15.4				2510-M12x35
AFM90-R390.17-D080-A27-Z07-H	●	80	7	27	50	15.4				2514-M16x35
AFM90-R390.17-D100-A32-Z08-H	●	100	8	32	50	15.4				-
AFM90-R390.17-D125-B40-Z09	●	125	9	40	63	15.4				-
AFM90-R390.18-D050-A22-Z04-H	●	50	4	22	40	15.4	R390-1806..	1515-M4x11		2508-M10x30
AFM90-R390.18-D063-A22-Z05-H	●	63	5	22	40	15.4				2510-M12x35
AFM90-R390.18-D080-A27-Z06-H	●	80	6	27	50	15.4				2514-M16x35
AFM90-R390.18-D100-A32-Z07-H	●	100	7	32	50	15.4				-
AFM90-R390.18-D125-B40-Z08	●	125	8	40	63	15.4				-

SNDVK Ucuna Uygunudur. / Compatible with SNDVK Insert.

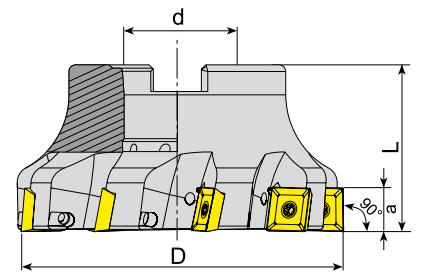

Takım Kodu Ordering Code	Stok Stock	Takım Ölçüleri (mm) Dimension (mm)					Kesici Uç Insert	Yedek Parçaları Spare Parts		
		D	Z	d	L	a		Sıkma Vidası Screw	Tork Anahtar Torx Key	Montaj Vidası Mounting Screw
AFM90-490R14-D050-A22-Z04-H	●	50	4	22	40	10	490R-1404..	4015-M3.5x11	80-T15	2508-M10x30
AFM90-490R14-D063-A22-Z05-H	●	63	5	22	40	10				2510-M12x35
AFM90-490R14-D080-A27-Z07-H	●	80	7	27	50	10				-

R: Sağ/Right L: Sol/Left ● Stokta/In Stock ○ Stokta Yok/Non Stock Item
SNDVK Ucuna Uygunudur. / Compatible with SNDVK Insert.

Sipariş Örneği/Ordering Example : 1 ad./pcs. AFM90-R390.11-D040-A16-Z05-H
Kesme Hesabı : S 271 / Cutting Calculation : P 271
Montaj Ölçüleri : S 269 / Mounting Reference : P 269

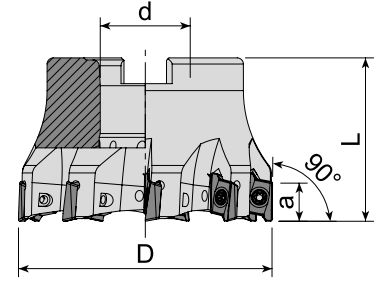

Takım Kodu Ordering Code	Stok Stock	Takım Ölçüleri (mm) Dimension (mm)					Kesici Uç Insert	Yedek Parçaları Spare Parts		
		D	Z	d	L	a		Sıkma Vidası Screw	Tork Anahtar Torx Key	Montaj Vidası Mounting Screw
AFM90-RT10-D040-A16-Z06-H	●	40	6	16	40	10	RT 1003..	3008-M2.5x6	80-T08	2506-M8x30
AFM90-RT10-D050-A22-Z07-H	●	50	7	22	40	10				2407-M10x30
AFM90-RT10-D063-A22-Z09-H	●	63	9	22	40	10				

SFTY Ucuna Uygundur. / Compatiple with SFTY Insert.

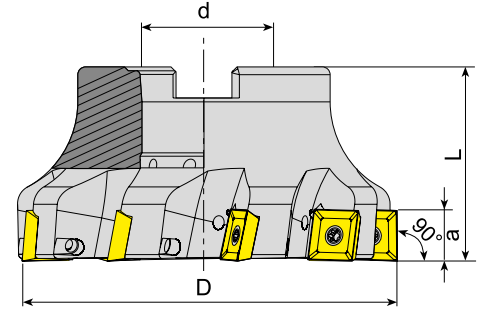

Takım Kodu Ordering Code	Stok Stock	Takım Ölçüleri (mm) Dimension (mm)					Kesici Uç Insert	Yedek Parçaları Spare Parts		
		D	Z	d	L	a		Sıkma Vidası Screw	Tork Anahtar Torx Key	Montaj Vidası Mounting Screw
AFM90-SD09M4-D040-A16-Z04-H	●	40	4	16	40	9	SD.. 09M4..	4015-M3.5x11	80-T15	2406-M8x30
AFM90-SD09M4-D050-A22-Z05-H	●	50	5	22	40	9				2508-M10x30
AFM90-SD09M4-D063-A22-Z06-H	●	63	6	22	40	9				
AFM90-SD1305-D050-A22-Z04-H	●	50	4	22	40	13	SD.. 1305..	1020-M5x11	80-T20	2408-M10x30
AFM90-SD1305-D063-A22-Z05-H	●	63	5	22	40	13				2508-M10x30
AFM90-SD1305-D080-A27-Z06-H	●	80	6	27	50	13				2510-M12x35
AFM90-SD1305-D100-A32-Z07-H	●	100	7	32	50	13				2514-M16x35
AFM90-SD1305-D125-B40-Z08	●	125	8	40	63	13				
AFM90-SD1305-D160-C40-Z10	●	160	10	40	63	13				-

R: Sağ/Right L: Sol/Left ● Stokta/In Stock ○ Stokta Yok/Non Stock Item
KRLY Ucuna Uygundur. / Compatiple with KRLY Insert.

Sipariş Örneği/Ordering Example : 1 ad./pcs. AFM90-RT10-D040-A16-Z06-H
Kesme Hesabı : S 271 / Cutting Calculation : P 271
Montaj Ölçüleri : S 269 / Mounting Reference : P 269

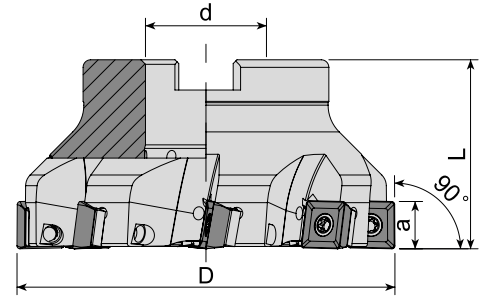

Takım Kodu Ordering Code	Stok Stock	Takım Ölçüleri (mm) Dimension (mm)					Kesici Uç Insert	Yedek Parçaları Spare Parts				
		D	Z	d	L	a		Altık Screw	Altık Vidası Wedge Clamp	Sıkma Vidası Screw	Tork Anahtar Torx Key	Montaj Vidası Mounting Screw
AFM90S-SD1204-D050-A22-Z04-H	●	50	4	22	40	11	SDMT 1204..	AASD-3-0001	AAV-06-M3.5x11	4015-M3.5x14	80-T15	2408-M10x30
AFM90S-SD1204-D063-A22-Z05-H	●	63	5	22	40	11						2508-M10x30
AFM90S-SD1204-D080-A27-Z06-H	●	80	6	27	50	11						2510-M12x35
AFM90S-SD1204-D100-A32-Z08-H	●	100	8	32	50	11						2514-M16x35
AFM90S-SD1204-D125-B40-Z10	●	125	10	40	63	11						-
AFM90S-SD1204-D160-C40-Z12	●	160	12	40	63	11						-

DJT Ucuna Uygundur. / Compatible with DJT Insert.

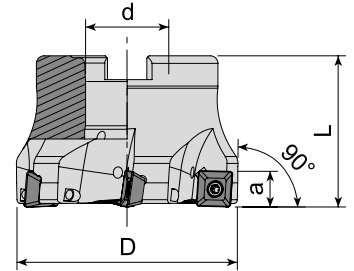

Takım Kodu Ordering Code	Stok Stock	Takım Ölçüleri (mm) Dimension (mm)					Kesici Uç Insert	Yedek Parçaları Spare Parts		
		D	Z	d	L	a		Sıkma Vidası Screw	Tork Anahtar Torx Key	Montaj Vidası Mounting Screw
AFM90-SE09-D040-A16-Z04-H	●	40	4	16	40	6.7	SEET 09T3..	1008-M3x8	80-T08	2506-M8x30
AFM90-SE09-D050-A22-Z05-H	●	50	5	22	40	6.7				2508-M10x30
AFM90-SE09-D063-A22-Z06-H	●	63	6	22	40	6.7				-

R: Sağ/Right L: Sol/Left ● Stokta/In Stock ○ Stokta Yok/Non Stock Item
ZCC Ucuna Uygundur. / Compatible with ZCC Insert.

Sipariş Örneği/Ordering Example : 1 ad./pcs. AFM90S-SD1204-D050-A22-Z04-H
Kesme Hesabı : S 271 / Cutting Calculation : P 271
Montaj Ölçüleri : S 269 / Mounting Reference : P 269

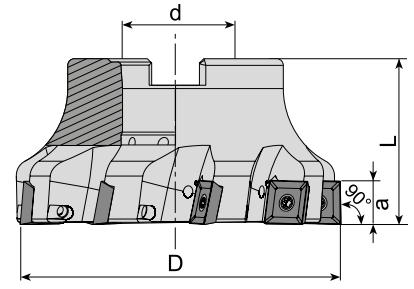

Takım Kodu Ordering Code	Stok Stock	Takım Ölçüleri (mm) Dimension (mm)					Kesici Uç Insert	Yedek Parçaları Spare Parts		
		D	Z	d	L	a		Sıkma Vidası Screw	Tork Anahtar Torx Key	Montaj Vidası Mounting Screw
AFM90-SE12-D050-A22-Z04-H	●	50	4	22	40	12	SEET 1203..	4015-M3.5x11	80-T15	2508-M10x30
AFM90-SE12-D063-A22-Z05-H	●	63	5	22	40	12				
AFM90-SE12-D080-A27-Z07-H	●	80	7	27	50	12				
AFM90-SE12-D100-A32-Z09-H	●	100	9	32	50	12				
AFM90-SE12-D125-B40-Z11	●	125	11	40	63	12				

ZCC Ucuna Uygundur. / Compatible with ZCC Insert.

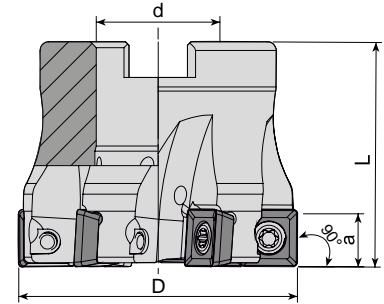

Takım Kodu Ordering Code	Stok Stock	Takım Ölçüleri (mm) Dimension (mm)					Kesici Uç Insert	Yedek Parçaları Spare Parts		
		D	Z	d	L	a		Sıkma Vidası Screw	Tork Anahtar Torx Key	Montaj Vidası Mounting Screw
AFM90-SP1004-D040-A16-Z04-H	●	40	4	16	40	9.4	SPMT 1004.. XPMT 1004.. QPMR 1004.. QPMT 1004..	4015-M4x10	80-T15	2506-M8x30
AFM90-SP1004-D050-A22-Z06-H	●	50	6	22	40	9.4				2508-M10x30

R: Sağ/Right L: Sol/Left ● Stokta/In Stock ○ Stokta Yok/Non Stock Item
ISCR Ucuna Uygundur. / Compatible with ISCR Insert.

Sipariş Örneği/Ordering Example : 1 ad./pcs. AFM90-SE12-D050-A22-Z04-H
Kesme Hesabı : S 271 / Cutting Calculation : P 271
Montaj Ölçüleri : S 269 / Mounting Reference : P 269

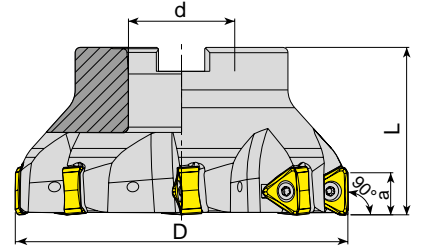

Takım Kodu Ordering Code	Stok Stock	Takım Ölçüleri (mm) Dimension (mm)					Kesici Uç Insert	Yedek Parçaları Spare Parts		
		D	Z	d	L	a		Sıkma Vidası Screw	Tork Anahtar Torx Key	Montaj Vidası Mounting Screw
AFM90-TN2207-D063-A22-Z04-H	●	63	4	22	40	15	TN.X 2207..			2508-M10x30
AFM90-TN2207-D080-A27-Z05-H	●	80	5	27	50	15				2510-M12x35
AFM90-TN2207-D100-B32-Z06	●	100	6	32	50	15				-
AFM90-TN2207-D125-B40-Z08	●	125	8	40	63	15				-

TGTC Ucuna Uygundur. / Compatiple with TGTC Insert.

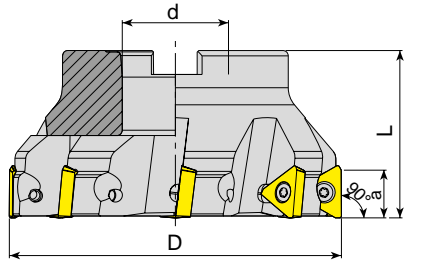

Takım Kodu Ordering Code	Stok Stock	Takım Ölçüleri (mm) Dimension (mm)					Kesici Uç Insert	Yedek Parçaları Spare Parts		
		D	Z	d	L	a		Sıkma Vidası Screw	Tork Anahtar Torx Key	Montaj Vidası Mounting Screw
AFM90-TP2205-D063-A22-Z04	●	63	4	22	40	18	TPKT 2205..			2508-M10x30
AFM90-TP2205-D080-A27-Z06	●	80	6	27	50	18				2510-M12x35
AFM90-TP2205-D100-A32-Z07	●	100	7	32	50	18				2514-M16x35
AFM90-TP2205-D125-B40-Z08	●	125	8	40	63	18				-
AFM90-TP2205-D160-C40-Z09	●	160	9	40	63	18				-
AFM90-TP2205-D200-C60-Z12	●	200	12	60	63	18				-

R: Sağ/Right L: Sol/Left ● Stokta/In Stock ○ Stokta Yok/Non Stock Item
TGTC Ucuna Uygundur. / Compatiple with TGTC Insert.

Sipariş Örneği/Ordering Example : 1 ad./pcs. AFM90-TN2207-D063-A22-Z04-H
Kesme Hesabı : S 271 / Cutting Calculation : P 271
Montaj Ölçüleri : S 269 / Mounting Reference : P 269

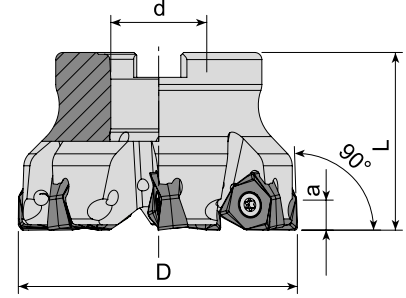

Takım Kodu Ordering Code	Stok Stock	Takım Ölçüleri (mm) Dimension (mm)					Kesici Uç Insert	Yedek Parçaları Spare Parts		
		D	Z	d	L	a		Sıkma Vidası Screw	Tork Anahtar Torx Key	Montaj Vidası Mounting Screw
AFM90-WN0806-D050-A16-Z04-H	●	50	4	16	40	8	WMMX 080608			2506-M8x30
AFM90-WN0806-D063-A22-Z05-H	●	63	5	22	40	8				2508-M10x30
AFM90-WN0806-D080-A27-Z07-H	●	80	7	27	50	8				2510-M12x35

KYCR-JD Ucuna Uygunudur. / Compatible with KYCR-JD Insert.

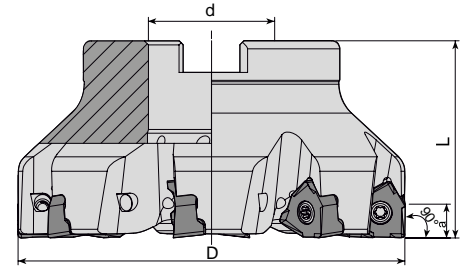

Takım Kodu Ordering Code	Stok Stock	Takım Ölçüleri (mm) Dimension (mm)					Kesici Uç Insert	Yedek Parçaları Spare Parts		
		D	Z	d	L	a		Sıkma Vidası Screw	Tork Anahtar Torx Key	Montaj Vidası Mounting Screw
AFM90-XN0806-D050-A22-Z04-H	●	50	4	22	40	7.5	XNEX 0806..			2508-M10x30
AFM90-XN0806-D063-A22-Z05-H	●	63	5	22	40	7.5				2510-M12x35
AFM90-XN0806-D080-A27-Z07-H	●	80	7	27	50	7.5				2514-M16x35
AFM90-XN0806-D100-A32-Z08-H	●	100	8	32	50	7.5				

R: Sağ/Right L: Sol/Left ● Stokta/In Stock ○ Stokta Yok/Non Stock Item
SC Ucuna Uygunudur. / Compatible with SC Insert.

Sipariş Örneği/Ordering Example : 1 ad./pcs. AFM90-WN0806-D050-A16-Z04-H
Kesme Hesabı : S 271 / Cutting Calculation : P 271
Montaj Ölçüleri : S 269 / Mounting Reference : P 269

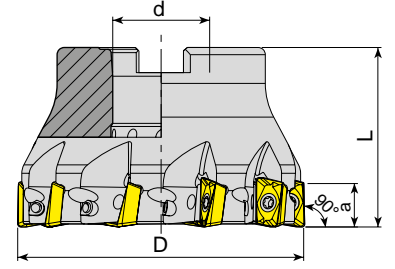

Takım Kodu Ordering Code	Stok Stock	Takım Ölçüleri (mm) Dimension (mm)					Kesici Uç Insert	Yedek Parçaları Spare Parts		
		D	Z	d	L	a		Sıkma Vidası Screw	Tork Anahtar Torx Key	Montaj Vidası Mounting Screw
AFM90-X012-D040-A16-Z05-H	●	40	5	16	40	11	XO.. 1204..			2506-M8x30
AFM90-X012-D050-A22-Z07-H	●	50	7	22	40	11				2508-M10x30
AFM90-X012-D063-A22-Z08-H	●	63	8	22	40	11				2510-M12x35
AFM90-X012-D080-A27-Z10-H	●	80	10	27	50	11				2514-M16x35
AFM90-X012-D100-A32-Z12-H	●	100	12	32	50	11				

SC Ucuna Uygundur. / Compatible with SC Insert.

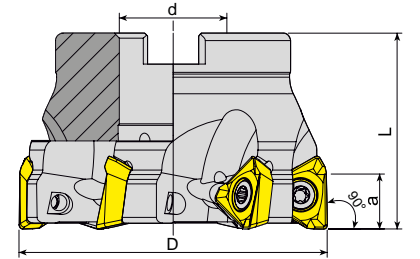

Takım Kodu Ordering Code	Stok Stock	Takım Ölçüleri (mm) Dimension (mm)					Kesici Uç Insert	Yedek Parçaları Spare Parts		
		D	Z	d	L	a		Sıkma Vidası Screw	Tork Anahtar Torx Key	Montaj Vidası Mounting Screw
AFM90-3P1004-D040-A16-Z05-H	●	40	5	16	40	7	3PKT 1004..			2506-M8x30
AFM90-3P1004-D050-A22-Z06-H	●	50	6	22	40	7				2508-M10x30
AFM90-3P1505-D050-A22-Z04-H	●	50	4	22	40	11	3PKT 1505..			2510-M12x35
AFM90-3P1505-D050-A22-Z05-H	●	50	5	22	40	11				2514-M16x35
AFM90-3P1505-D063-A22-Z04-H	●	63	4	22	40	11				
AFM90-3P1505-D063-A22-Z06-H	●	63	6	22	40	11				

R: Sağ/Right L: Sol/Left ● Stokta/In Stock ○ Stokta Yok/Non Stock Item
TGTC Ucuna Uygundur. / Compatible with TGTC Insert.

Sipariş Örneği/Ordering Example : 1 ad./pcs. AFM90-X012-D040-A16-Z05-H
Kesme Hesabı : S 271 / Cutting Calculation : P 271
Montaj Ölçüleri : S 269 / Mounting Reference : P 269

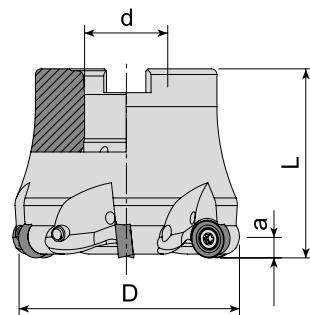

Takım Kodu Ordering Code	Stok Stock	Takım Ölçüleri (mm) Dimension (mm)					Kesici Uç Insert	Yedek Parçaları Spare Parts				
		D	Z	d	L	a		Sıkma Vidası Screw	Tork Anahtar Torx Key	Montaj Vidası Mounting Screw		
AFMR-RC10T3-D040-A16-Z04-H	●	40	4	16	40	5	RC.. 10T3..			2406-M8x30		
AFMR-RC10T3-D050-A22-Z05-H	●	50	5	22	50	5				1515-M4x11	80-T15	2508-M10x30
AFMR-RC10T3-D063-A22-Z06-H	●	63	6	22	50	5						

ZCC Ucuna Uygundur. / Compatible with ZCC Insert.

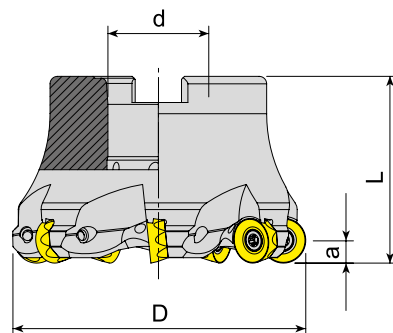

Takım Kodu Ordering Code	Stok Stock	Takım Ölçüleri (mm) Dimension (mm)					Kesici Uç Insert	Yedek Parçaları Spare Parts				
		D	Z	d	L	a		Sıkma Vidası Screw	Tork Anahtar Torx Key	Montaj Vidası Mounting Screw		
AFMR-RC1204-D040-A16-Z04-H	●	40	4	16	40	6	RC.. 1204..			2506-M8x30		
AFMR-RC1204-D052-A22-Z05-H	●	52	5	22	50	6				4015-M3.5x11	80-T15	2508-M10x30
AFMR-RC1204-D050-A22-Z05-H	●	50	5	22	50	6						2510-M12x35
AFMR-RC1204-D063-A22-Z06-H	●	63	6	22	50	6						
AFMR-RC1204-D080-A27-Z07-H	●	80	7	27	50	6						

R: Sağ/Right L: Sol/Left ● Stokta/In Stock ○ Stokta Yok/Non Stock Item
SNDVK Ucuna Uygundur. / Compatible with SNDVK Insert.

Sipariş Örneği/Ordering Example : 1 ad./pcs. AFMR-RC10T3-D040-A16-Z04-H
Kesme Hesabı : S 271 / Cutting Calculation : P 271
Montaj Ölçüleri : S 269 / Mounting Reference : P 269

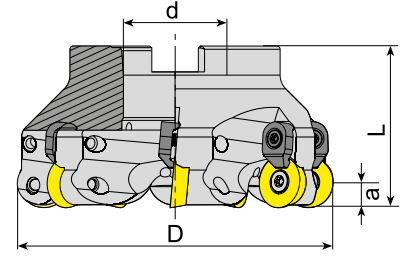

Takım Kodu Ordering Code	Stok Stock	Takım Ölçüleri (mm) Dimension (mm)					Kesici Uç Insert	Yedek Parçaları Spare Parts				
		D	Z	d	L	a		Sıkma Vidası Screw	Baskı Parçası Wedge Clamp	Baskı Vidası Clamp Screw	Tork Anahtar Torx Key	Montaj Vidası Mounting Screw
AFMR-RD0702-D050-A22-Z06-H	●	50	6	22	40	3.5	RD.. 0702..	3008-M2.5x6	-	-	80-T08	2407-M10x30
AFMR-RD0803-D050-A22-Z05-H	●	50	5	22	40	4	RD.. 0803..	1008-M3x8	-	-	80-T08	2407-M10x30
AFMRC-RD1003-D040-A16-Z04-H	●	40	4	16	40	5	RD.. 1003..					2406-M8x30
AFMRC-RD1003-D050-A22-Z05-H	●	50	5	22	50	5						2508-M10x30
AFMRC-RD1003-D063-A22-Z06-H	●	63	6	22	50	5						2510-M12x35
AFMRC-RD1003-D080-A27-Z07-H	●	80	7	27	50	5						2514-M16x35
AFMRC-RD1003-D100-A32-Z08-H	●	100	8	32	50	5						
AFMRC-RD10T3-D050-A22-Z05-H	●	50	5	22	50	5						RD.. 10T3..
AFMRC-RD10T3-D063-A22-Z06-H	●	63	6	22	50	5	RD.. 12T3..	4015-M3.5x11	ACK-15	1015-M3.5x11	80-T15	2406-M8x30
AFMRC-RD12T3-D040-A16-Z04-H	●	40	4	16	40	6						2508-M10x30
AFMRC-RD12T3-D050-A22-Z05-H	●	50	5	22	50	6						2510-M12x35
AFMRC-RD12T3-D052-A22-Z05-H	●	52	5	22	50	6						2514-M16x35
AFMRC-RD12T3-D063-A22-Z06-H	●	63	6	22	50	6						
AFMRC-RD12T3-D080-A27-Z07-H	●	80	7	27	50	6						
AFMRC-RD12T3-D100-A32-Z08-H	●	100	8	32	50	6	RD.. 1204..					2514-M16x35
AFMRC-RD12T3-D125-B40-Z09	●	125	9	40	63	6						
AFMRC-RD1204-D040-A16-Z04-H	●	40	4	16	40	6						2406-M8x30
AFMRC-RD1204-D050-A22-Z05-H	●	50	5	22	50	6						2508-M10x30
AFMRC-RD1204-D052-A22-Z05-H	●	52	5	22	50	6						2510-M12x35
AFMRC-RD1204-D063-A22-Z06-H	●	63	6	22	50	6						2514-M16x35
AFMRC-RD1204-D080-A27-Z07-H	●	80	7	27	50	6	RD.. 1604..	1515-M4.5x11	ACK-05	1515-M4x11		2408-M10x30
AFMRC-RD1204-D100-A32-Z07-H	●	100	7	32	50	6						2508-M10x30
AFMRC-RD1204-D100-A32-Z08-H	●	100	8	32	50	6						2510-M12x35
AFMRC-RD1604-D050-A22-Z04-H	●	50	4	22	50	8						2514-M16x35
AFMRC-RD1604-D052-A22-Z04-H	●	52	4	22	50	8						
AFMRC-RD1604-D063-A22-Z05-H	●	63	5	22	50	8						
AFMRC-RD1604-D066-A22-Z05-H	●	66	5	22	50	8	RD.. 1604..	1515-M4.5x11	ACK-05	1515-M4x11		2510-M12x35
AFMRC-RD1604-D066-A27-Z05-H	●	66	5	27	50	8						2514-M16x35
AFMRC-RD1604-D080-A27-Z06-H	●	80	6	27	50	8						
AFMRC-RD1604-D100-A32-Z07-H	●	100	7	32	50	8						
AFMRC-RD1604-D100-A32-Z08-H	●	100	8	32	50	8						
AFMRC-RD1604-D125-B40-Z07	●	125	7	40	63	8						

R: Sağ/Right L: Sol/Left ● Stokta/In Stock ○ Stokta Yok/Non Stock Item
ISO Ucuna Uygundur. / Compatible with ISO Insert.

Sipariş Örneği/Ordering Example : 1 ad./pcs. AFMR-RD0702-D050-A22-Z06-H

Kesme Hesabı : S 271 / Cutting Calculation : P 271

Montaj Ölçüleri : S 269 / Mounting Reference : P 269



www.akkocom.tr

Дистрибьютер ООО "Ресурс Плюс"
+7 (351) 247-74-40; info@rp-ural.ru

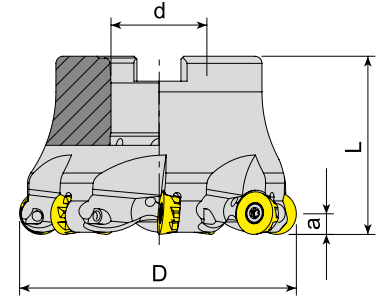

Takım Kodu Ordering Code	Stok Stock	Takım Ölçüleri (mm) Dimension (mm)					Kesici Uç Insert	Yedek Parçaları Spare Parts		
		D	Z	d	L	a		Sıkma Vidası Screw	Tork Anahtar Torx Key	Montaj Vidası Mounting Screw
AFMR-RP10T3-D063-A22-Z06-H	●	63	6	22	40	5	RPNX 10T3..	4010-M3x8	80-T10	2508-M10x30
AFMR-RP10T3-D080-A27-Z07-H	●	80	7	27	50	5				2510-M12x35
AFMR-RP1204-D040-A16-Z04-H	●	40	4	16	40	6	RPNX 1204..	4015-M3.5x11	80-T15	2406-M8x30
AFMR-RP1204-D080-A27-Z07-H	●	80	7	27	50	6				2510-M12x35

CRTZT Ucuna Uygun. / Compatible with CRTZT Insert.

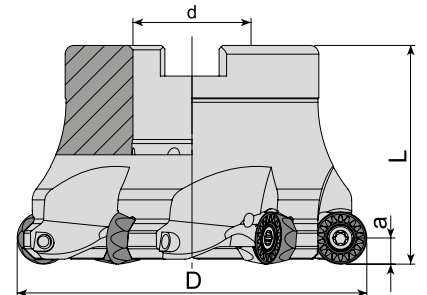

Takım Kodu Ordering Code	Stok Stock	Takım Ölçüleri (mm) Dimension (mm)					Kesici Uç Insert	Yedek Parçaları Spare Parts		
		D	Z	d	L	a		Sıkma Vidası Screw	Tork Anahtar Torx Key	Montaj Vidası Mounting Screw
AFMR-RP1204M-D050-A22-Z04-H	●	50	4	22	50	6	RPMT 1204..	4015-M4x11	80-T15	2508-M10x30
AFMR-RP1204M-D052-A22-Z05-H	●	52	5	22	50	6				2510-M12x35
AFMR-RP1204M-D063-A22-Z05-H	●	63	5	22	50	6				
AFMR-RP1204M-D080-A27-Z06-H	●	80	6	27	50	6				

R: Sağ/Right L: Sol/Left ● Stokta/In Stock ○ Stokta Yok/Non Stock Item
MTSBH Ucuna Uygun. / Compatible with MTSBH Insert.

Sipariş Örneği/Ordering Example : 1 ad./pcs. AFMR-RP10T3-D063-A22-Z06-H

Kesme Hesabı : S 271 / Cutting Calculation : P 271

Montaj Ölçüleri : S 269 / Mounting Reference : P 269

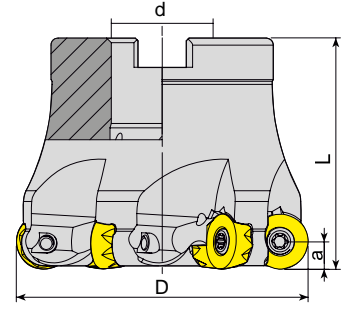

Takım Kodu Ordering Code	Stok Stock	Takım Ölçüleri (mm) Dimension (mm)					Kesici Uç Insert	Yedek Parçaları Spare Parts		
		D	Z	d	L	a		Sıkma Vidası Screw	Tork Anahtar Torx Key	Montaj Vidası Mounting Screw
AFMR-RY10-D040-A16-Z04-H	●	40	4	16	40	5	RYMX 1004..	4015-M3.5x8	80-T15	2406-M8x30
AFMR-RY10-D050-A22-Z05-H	●	50	5	22	50	5				2508-M10x30
AFMR-RY10-D063-A22-Z06-H	●	63	6	22	50	5				2406-M8x30
AFMR-RY12-D040-A16-Z04-H	●	40	4	16	40	6	RYMX 1205..	4015-M4x11	80-T15	2406-M8x30
AFMR-RY12-D050-A22-Z05-H	●	50	5	22	50	6				2508-M10x30
AFMR-RY12-D052-A22-Z05-H	●	52	5	22	50	6				
AFMR-RY12-D063-A22-Z06-H	●	63	6	22	50	6				

TGTC Ucuna Uygundur. / Compatible with TGTC Insert.

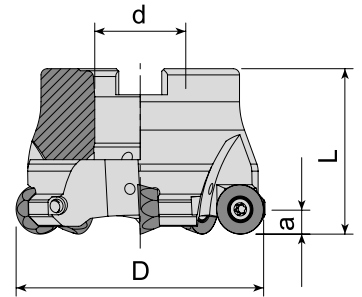

Takım Kodu Ordering Code	Stok Stock	Takım Ölçüleri (mm) Dimension (mm)					Kesici Uç Insert	Yedek Parçaları Spare Parts		
		D	Z	d	L	a		Sıkma Vidası Screw	Tork Anahtar Torx Key	Montaj Vidası Mounting Screw
AFMR-QP10T3-D040-A16-Z04-H	●	40	4	16	40	5	QP.. 10T3..	4015-M3.5x11	80-T15	2506-M8x30
AFMR-QP10T3-D050-A22-Z05-H	●	50	5	22	40	5				2407-M10x30
AFMR-QP10T3-D063-A22-Z06-H	●	63	6	22	40	5				
AFMR-QP1204-D050-A22-Z04-H	●	50	4	22	40	6	QP.. 1204..	1515-M4x11		
AFMR-QP1204-D063-A22-Z05-H	●	63	5	22	40	6				

R: Sağ/Right L: Sol/Left ● Stokta/In Stock ○ Stokta Yok/Non Stock Item
SMTM Ucuna Uygundur. / Compatible with SMTM Insert.

Sipariş Örneği/Ordering Example : 1 ad./pcs. AFMR-RY10-D040-A16-Z04-H
Kesme Hesabı : S 271 / Cutting Calculation : P 271
Montaj Ölçüleri : S 269 / Mounting Reference : P 269

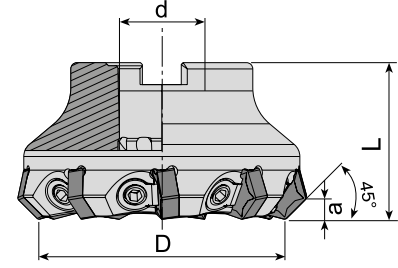

Takım Kodu Ordering Code	Stok Stock	Takım Ölçüleri (mm) Dimension (mm)					Kesici Uç Insert	Yedek Parçaları Spare Parts			
		D	Z	d	L	a		Baskı Pabucu Wedge Clamp	Baskı Vidası Clamp Screw	Anahtar Allen Key	Montaj Vidası Mounting Screw
AFM45C-HN0905-D063-A22-Z07	●	63	7	22	40	4.5	HN.. 0905..	ACK-11	AKV-15-M8x1x20	AAL-05-4	2508-M10x30
AFM45C-HN0905-D080-A27-Z09	●	80	9	27	50	4.5					2510-M12x35
AFM45C-HN0905-D100-A32-Z11	●	100	11	32	50	4.5					2514-M16x35
AFM45C-HN0905-D125-B40-Z13	●	125	13	40	63	4.5					-
AFM45CL-HN0905-D125-B40-Z10	●	125	10	40	63	4.5					-
AFM45C-HN0905-D160-C40-Z15	●	160	15	40	63	4.5					-

WDA-KNMTL Ucuna Uygundur. / Compatible with WDA-KNMTL Insert.

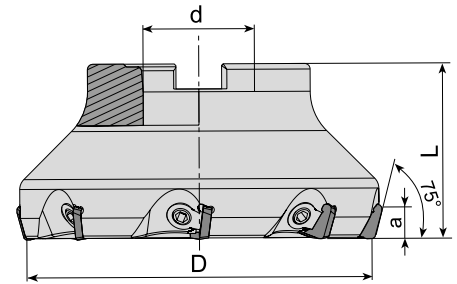

Takım Kodu Ordering Code	Stok Stock	Takım Ölçüleri (mm) Dimension (mm)					Kesici Uç Insert	Yedek Parçaları Spare Parts			
		D	Z	d	L	a		Baskı Pabucu Wedge Clamp	Baskı Vidası Clamp Screw	Anahtar Allen Key	Montaj Vidası Mounting Screw
AFM75C-SP12-D050-A22-Z04	●	50	4	22	42	8	SPKN 1203..	ACK-10	AKV-13-M8x1x16	AAL-05-4	2508-M10x30
AFM75C-SP12-D063-A22-Z05	●	63	5	22	40	8					2510-M12x35
AFM75C-SP12-D080-A27-Z06	●	80	6	27	50	8					2514-M16x35
AFM75C-SP12-D100-A32-Z07	●	100	7	32	50	8					-
AFM75C-SP12-D125-B40-Z08	●	125	8	40	63	8					-
AFM75C-SP12-D160-C40-Z09	●	160	9	40	63	8					-
AFM75C-SP12-D200-C60-Z12	●	200	12	60	63	8					-

R: Sağ/Right L: Sol/Left ● Stokta/In Stock ○ Stokta Yok/Non Stock Item
ISO Ucuna Uygundur. / Compatible with ISO Insert.

Sipariş Örneği/Ordering Example : 1 ad./pcs. AFM45C-HN0905-D063-A22-Z07
Kesme Hesabı : S 271 / Cutting Calculation : P 271
Montaj Ölçüleri : S 269 / Mounting Reference : P 269

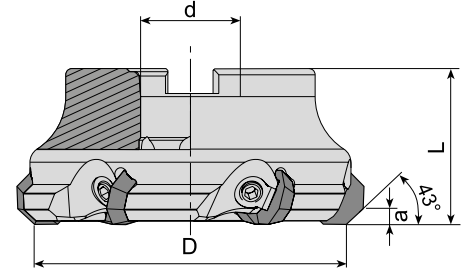

Takım Kodu Ordering Code	Stok Stock	Takım Ölçüleri (mm) Dimension (mm)					Kesici Uç Insert	Yedek Parçaları Spare Parts			
		D	Z	d	L	a		Baskı Pabucu Wedge Clamp	Baskı Vidası Clamp Screw	Anahtar Allen Key	Montaj Vidası Mounting Screw
AFM43C-OF07-D063-A22-Z04	●	63	4	22	45	5	OF.. 0704..	ACK-11	AKV-15-M8x1x20	AAL-05-4	2508-M10x30
AFM43C-OF07-D080-A27-Z05	●	80	5	27	50	5					2510-M12x35
AFM43C-OF07-D100-A32-Z06	●	100	6	32	50	5					2514-M16x35
AFM43C-OF07-D125-B40-Z08	●	125	8	40	63	5					-
AFM43C-OF07-D160-C40-Z09	●	160	9	40	63	5					-

ISO Ucuna Uygundur. / Compatible with ISO Insert.

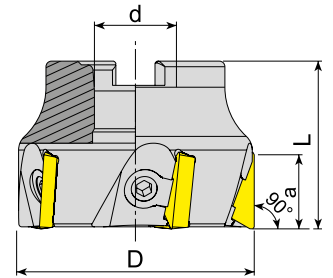





Takım Kodu Ordering Code	Stok Stock	Takım Ölçüleri (mm) Dimension (mm)					Kesici Uç Insert	Yedek Parçaları Spare Parts			
		D	Z	d	L	a		Baskı Pabucu Wedge Clamp	Baskı Vidası Clamp Screw	Anahtar Allen Key	Montaj Vidası Mounting Screw
AFM90C-TP16-D050-A22-Z04	●	50	4	22	40	12	TP.. 1603..	ACK-10	AKV-22-M8x1x14 AKV-13-M8x1x16	AAL-05-4	2407-M10x30
AFM90C-TP16-D063-A22-Z06	●	63	6	22	45	12					2508-M10x30
AFM90C-TP16-D080-A27-Z07	●	80	7	27	50	12					2510-M12x35
AFM90C-TP16-D100-A32-Z08	●	100	8	32	50	12					2514-M16x35
AFM90C-TP16-D125-B40-Z08	●	125	8	40	63	12					-
AFM90C-TP22-D063-A22-Z05	●	63	5	22	45	18	TP.. 2204..	ACK-11	AKV-14-M8x1x18	AAL-05-4	2508-M10x30
AFM90C-TP22-D080-A27-Z06	●	80	6	27	50	18					2510-M12x35
AFM90C-TP22-D100-A32-Z07	●	100	7	32	50	18					2514-M16x35
AFM90C-TP22-D125-B40-Z08	●	125	8	40	63	18					-
AFM90C-TP22-D160-C40-Z09	●	160	9	40	63	18					-
AFM90C-TP22-D200-C60-Z12	●	200	12	60	63	18					-
AFM90C-TP22-D250-C60-Z15	●	250	15	60	63	18					-
AFM90C-TP22-D315-D60-Z18	●	315	18	60	63	18	-				

R: Sağ/Right L: Sol/Left ● Stokta/In Stock ○ Stokta Yok/Non Stock Item
ISO Ucuna Uygundur. / Compatible with ISO Insert.

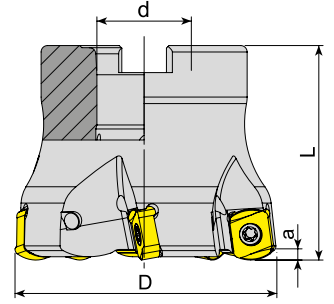
Sipariş Örneği/Ordering Example : 1 ad./pcs. AFM43C-OF07-D063-A22-Z04
Kesme Hesabı : S 271 / Cutting Calculation : P 271
Montaj Ölçüleri : S 269 / Mounting Reference : P 269



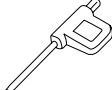

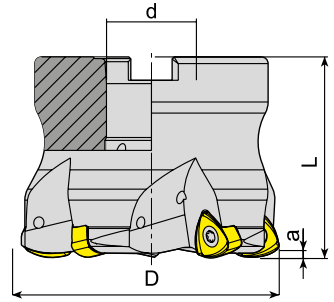

Takım Kodu Ordering Code	Stok Stock	Takım Ölçüleri (mm) Dimension (mm)					Kesici Uç Insert	Yedek Parçaları Spare Parts		
		D	Z	d	L	a		Sıkma Vidası Screw	Tork Anahtar Torx Key	Montaj Vidası Mounting Screw
AHFM-BL0904-D050-A22-Z06-H	●	50	6	22	50	2				
AHFM-BL0904-D063-A22-Z05-H	●	63	5	22	50	2				
AHFM-BL0904-D063-A22-Z07-H	●	63	7	22	50	2				

TGTC Ucuna Uygun. / Compatible with TGTC Insert.





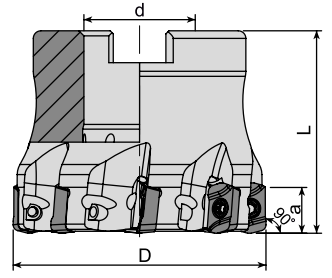

Takım Kodu Ordering Code	Stok Stock	Takım Ölçüleri (mm) Dimension (mm)					Kesici Uç Insert	Yedek Parçaları Spare Parts		
		D	Z	d	L	a		Sıkma Vidası Screw	Tork Anahtar Torx Key	Montaj Vidası Mounting Screw
AHFM-BL1205-D050-A22-Z03-H	●	50	3	22	40	2				
AHFM-BL1205-D063-A22-Z04-H	●	63	4	22	40	2				
AHFM-BL1205-D080-A27-Z05-H	●	80	5	27	50	2				

R: Sağ/Right L: Sol/Left ● Stokta/In Stock ○ Stokta Yok/Non Stock Item
TGTC Ucuna Uygun. / Compatible with TGTC Insert.









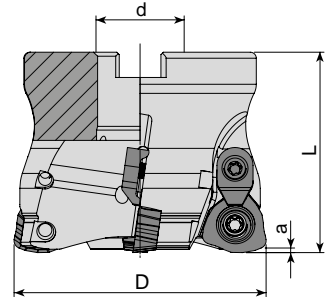

Sipariş Örneği/Ordering Example : 1 ad./pcs. AHFM-BL0904-D050-A22-Z06-H
Kesme Hesabı : S 271 / Cutting Calculation : P 271
Montaj Ölçüleri : S 269 / Mounting Reference : P 269

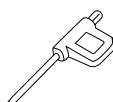

Takım Kodu Ordering Code	Stok Stock	Takım Ölçüleri (mm) Dimension (mm)					Kesici Uç Insert	Yedek Parçaları Spare Parts		
		D	Z	d	L	a		Sıkma Vidası Screw	Tork Anahtar Torx Key	Montaj Vdası Torx Key
AHFM-EP1003-D050-A22-Z08-H	●	50	8	22	40	1	 EP.. 1003.. ZPMT 1003.. YPHW 1003..	 3008-M2.5X6	 80-T08	 2508-M10x30
AHFM-EP1003-D063-A22-Z08-H	●	63	8	22	40	1				

DJT Ucuna Uygundur. / Compatiple with DJT Insert.



Takım Kodu Ordering Code	Stok Stock	Takım Ölçüleri (mm) Dimension (mm)					Kesici Uç Insert	Yedek Parçaları Spare Parts				
		D	Z	d	L	a		Sıkma Vidası Screw	Baskı Parçası Wedge Clamp	Baskı Vidası Clamp Screw	Tork Anahtar Torx Key	Montaj Vidası Mounting Screw
AHFMC-JD1204-D052-A22-Z03-H	●	52	3	22	50	1.5	 JDMW 1204..	 1615-M4x11	 ACK-05	 1515-M4x11	 80-T15	 2508-M10x30
AHFMC-JD1204-D052-A22-Z04-H	●	52	4	22	50	1.5						
AHFMC-JD1405-D052-A22-Z03-H	●	52	3	22	40	2	 JDMW 1405..	 1020-M5x11	 1515-M4x11	 80-T20	 2408-M10x30	
AHFMC-JD1405-D063-A22-Z04-H	●	63	4	22	40	2						

R: Sağ/Right L: Sol/Left ● Stokta/In Stock ○ Stokta Yok/Non Stock Item
MTSBH Ucuna Uygundur. / Compatiple with MTSBH Insert.

Sipariş Örneği/Ordering Example : 1 ad./pcs. AHFM-EP1003-D050-A22-Z08-H
Kesme Hesabı : S 271 / Cutting Calculation : P 271
Montaj Ölçüleri : S 269 / Mounting Reference : P 269

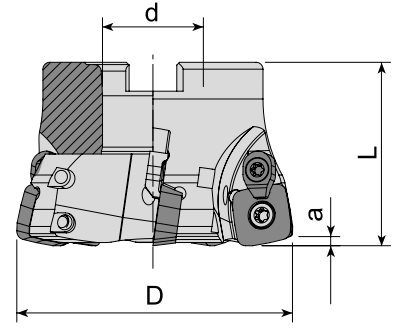

Takım Kodu Ordering Code	Stok Stock	Takım Ölçüleri (mm) Dimension (mm)					Kesici Uç Insert	Yedek Parçaları Spare Parts				
		D	Z	d	L	a		Sıkma Vidası Screw	Baskı Parçası Wedge Clamp	Baskı Vidası Clamp Screw	Tork Anahtar Torx Key	Montaj Vidası Mounting Screw
AHFMC-SD1204-D050-A22-Z04-H	●	50	4	22	40	1.8	SD.. 1204..					
AHFMC-SD1204-D063-A22-Z05-H	●	63	5	22	40	1.8						
AHFMC-SD1204-D080-A27-Z06-H	●	80	6	27	50	1.8						
AHFMC-SD1204-D100-A32-Z08-H	●	100	8	32	50	1.8						

ZCC Ucuna Uygun. / Compatible with ZCC Insert.

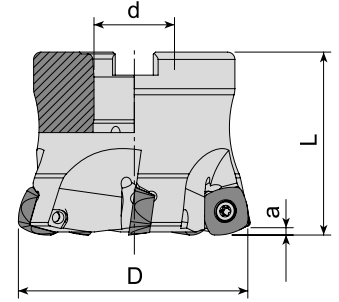



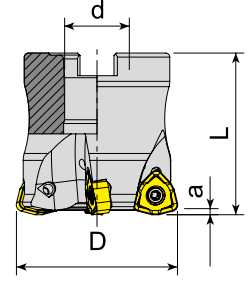

Takım Kodu Ordering Code	Stok Stock	Takım Ölçüleri (mm) Dimension (mm)					Kesici Uç Insert	Yedek Parçaları Spare Parts		
		D	Z	d	L	a		Sıkma Vidası Screw	Tork Anahtar Torx Key	Montaj Vidası Mounting Screw
AHFM-SD1205-D052-A22-Z04-H	●	52	4	22	50	2	SD.. 1205..			
AHFM-SD1205-D052-A22-Z05-H	●	52	5	22	50	2				
AHFM-SD1205-D066-A22-Z05-H	●	66	5	22	50	2				
AHFM-SD1205-D066-A22-Z06-H	●	66	6	22	50	2				
AHFM-SD1205-D080-A27-Z06-H	●	80	6	27	70	2				

R: Sağ/Right L: Sol/Left ● Stokta/In Stock ○ Stokta Yok/Non Stock Item
HTCH Ucuna Uygun. / Compatible with HTCH Insert.









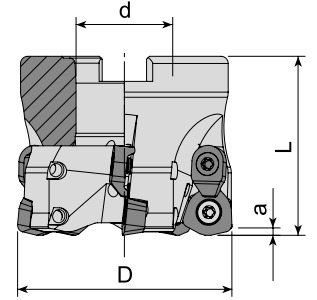



Sipariş Örneği/Ordering Example : 1 ad./pcs. AHFMC-SD1204-D050-A22-Z04-H
Kesme Hesabı : S 271 / Cutting Calculation : P 271
Montaj Ölçüleri : S 269 / Mounting Reference : P 269



Takım Kodu Ordering Code	Stok Stock	Takım Ölçüleri (mm) Dimension (mm)					Kesici Uç Insert	Yedek Parçaları Spare Parts			
		D	Z	d	L	a		Sıkma Vidası Screw	Tork Anahtar Torx Key	Montaj Vidası Mounting Screw	
AHFM-WN09T3-D040-A16-Z04-H	●	40	4	16	40	1.5					
AHFML-WN09T3-D040-A16-Z04-H	●	40	4	16	40	1.5					
AHFM-WN09T3-D050-A22-Z05-H	●	50	5	22	40	1.5					
AHFML-WN09T3-D050-A22-Z05-H	●	50	5	22	40	1.5					
AHFM-WN09T3-D063-A22-Z06-H	●	63	6	22	40	1.5					

KRLY Ucuna Uygun. / Compatible with KRLY Insert.



Takım Kodu Ordering Code	Stok Stock	Takım Ölçüleri (mm) Dimension (mm)					Kesici Uç Insert	Yedek Parçaları Spare Parts				
		D	Z	d	L	a		Sıkma Vidası Screw	Baskı Parçası Wedge Clamp	Baskı Vidası Clamp Screw	Tork Anahtar Torx Key	Montaj Vidası Mounting Screw
AHFMC-WD0804-D040-A16-Z04-H	●	40	4	16	40	-						
AHFMC-WD0804-D050-A22-Z04-H	●	50	4	22	50	-						
AHFMC-WD1205-D050-A22-Z04-H	●	50	4	22	50	-						
AHFMC-WD1205-D052-A22-Z04-H	●	52	4	22	50	-						
AHFMC-WD1205-D063-A22-Z05-H	●	63	5	22	50	-						
AHFMC-WD1205-D080-A27-Z06-H	●	80	6	27	63	-						

R: Sağ/Right L: Sol/Left ● Stokta/In Stock ○ Stokta Yok/Non Stock Item
SMTM Ucuna Uygun. / Compatible with SMTM Insert.

Sipariş Örneği/Ordering Example : 1 ad./pcs. AHFM-WN09T3-D040-A16-Z04-H
Kesme Hesabı : S 271 / Cutting Calculation : P 271
Montaj Ölçüleri : S 269 / Mounting Reference : P 269

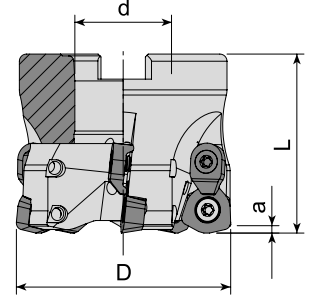

Takım Kodu Ordering Code	Stok Stock	Takım Ölçüleri (mm) Dimension (mm)					Kesici Uç Insert	Yedek Parçaları Spare Parts									
		D	Z	d	L	a		Sıkma Vidası Screw	Baskı Parçası Wedge Clamp	Baskı Vidası Clamp Screw	Tork Anahtar Torx Key	Montaj Vidası Mounting Screw					
AHFMC-WD06T3D-D042-A16-Z04-H	●	42	4	16	45	1.5	WD.W 06T3..						2506-M8x30				
AHFMC-WD06T3D-D050-A22-Z05-H	●	50	5	22	50	1.5							3015-M3.5x9	ACK-15	4015-M3.5x11	80-T15	2508-M10x30
AHFMC-WD06T3D-D052-A22-Z05-H	●	52	5	22	50	1.5											
AHFMC-WD0805D-D052-A22-Z04-H	●	52	4	22	50	2	WD.W 0805..										
AHFMC-WD0805D-D063-A27-Z05-H	●	63	5	27	50	2							4020-M4.5x12	ACK-19	4020-M4.5x12	80-T20	2510-M12x35
AHFMC-WD0805D-D066-A27-Z05-H	●	66	5	27	50	2											
AHFMC-WD0805D-D080-A27-Z05	●	80	5	27	50	2											2514-M16x35
AHFMC-WD0805D-D100-A32-Z06	●	100	6	32	50	2	WD.W 10X6..										
AHFMC-WD10X6D-D125-B40-Z06	●	125	6	40	63	2.5											
AHFMC-WD10X6D-D160-C40-Z07	●	160	7	40	63	2.5											

R: Sağ/Right L: Sol/Left ● Stokta/In Stock ○ Stokta Yok/Non Stock Item
DJT Ucuna Uygunudur. / Compatible with DJT Insert.

Sipariş Örneği/Ordering Example : 1 ad./pcs. AHFMC-WD06T3D-D042-A16-Z04-H
Kesme Hesabı : S 271 / Cutting Calculation : P 271
Montaj Ölçüleri : S 269 / Mounting Reference : P 269



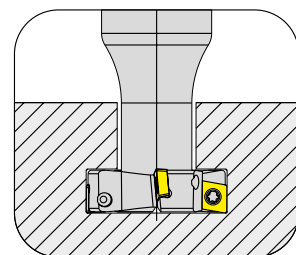
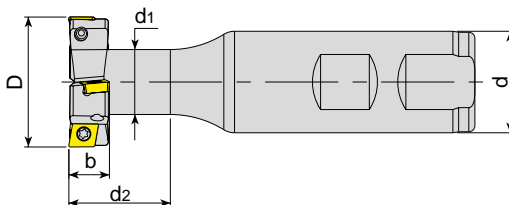

Takım Kodu
Ordering Code

Takım Kodu Ordering Code	Stok Stock	Takım Ölçüleri (mm) Dimension (mm)							Yedek Parçaları Spare Parts			
		Z		D	b	d	L	d ₁	d ₂	Kesici Uç Insert	Sıkma Vidası Screw	Tork Anahtar Torx Key
		Toplam Total	Etkili Effective									
ATSM90-CC06-D17X8-W16-L85-Z02	●	2	1	17	8	16	85	10	16	CC.. 0602..	3008-M2.5x6	80-T08
ATSM90-CC06-D32X8-W25-L100-Z04	●	4	2	32	8	25	100	16	23			
ATSM90-CC06-D28X8-W20-L66-Z04	●	4	2	28	8	20	66	14	15.5			
ATSM90-CC06-D45.5X8-W25-L100-Z06	●	6	3	45.5	8	25	100	12	30			
ATSM90-CC06-D63X8-W32-L125-Z08	●	8	4	63	8	32	125	31.5	30			
ATSM90-CC06-D18X9-W16-L90-Z02	●	2	1	18	9	16	90	10	16			
ATSM90-CC06-D20X9-W16-L85-Z04	●	4	2	20	9	16	85	10	16			
ATSM90-CC06-D23X10-W20-L90-Z04	●	4	2	23	10	20	90	12	25			
ATSM90-CC06-D32X10-W25-L100-Z04	●	4	2	32	10	25	100	16	25			
ATSM90-CC06-D45X10-W32-L120-Z06	●	6	3	45	10	32	120	20	25			
ATSM90-CC06-D25X11-W25-L100-Z04	●	4	2	25	11	25	100	13	20			
ATSM90-CC09-D30X12-W25-L100-Z04	●	4	2	30	12	25	100	16	25	CC.. 09T3..	4015-M3.5x9	80-T15
ATSM90-CC09-D32X12-W25-L100-Z02	●	2	1	32	12	25	100	16	25			
ATSM90-CC09-D32X12-W25-L100-Z04	●	4	2	32	12	25	100	16	25			
ATSM90-CC09-D32X14-W25-L100-Z04	●	4	2	32	14	25	100	16	25			
ATSM90-CC09-D37X16-W32-L120-Z04	●	4	2	37	16	32	120	17	30			
ATSM90-CC09-D42X17-W32-L120-Z04	●	4	2	42	17	32	120	19	30			
ATSM90-CC09-D40X17-W32-L120-Z04-H	●	4	2	40	17	32	120	19	30			
ATSM90-CC12-D47X20-W32-L120-Z04	●	4	2	47	20	32	120	25	45	CC.. 1204..	1020-M5x11	80-T20
ATSM90-CC12-D52X21-W32-L120-Z04	●	4	2	52	21	32	120	25	45			
ATSM90-CC12-D50X22-W32-L120-Z04	●	4	2	50	22	32	120	25	45			
ATSM90-CC12-D55X22-W32-L120-Z04	●	4	2	55	22	32	120	25	45			

R: Sağ/Right L: Sol/Left ● Stokta/In Stock ○ Stokta Yok/Non Stock Item

Sipariş Örneği/Ordering Example : 1 ad./pcs. ATSM90-CC06-D17X8-W16-L85-Z02
Kesme Hesabı : S 271 / Cutting Calculation : P 271



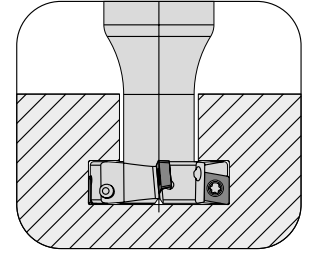
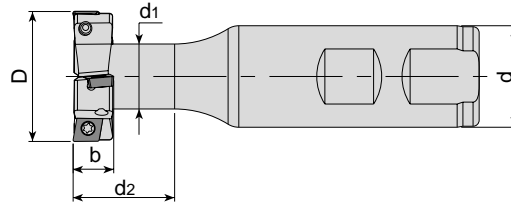

Takım Kodu Ordering Code	Stok Stock	Takım Ölçüleri (mm) Dimension (mm)								Yedek Parçaları Spare Parts		
		Z		D	b	d	L	d ₁	d ₂	Kesici Uç Insert	Sıkma Vidası Screw	Tork Anahtar Torx Key
		Toplam Total	Etkili Effective									
ATSM90-SP..05-D22.5X5-W25-L100-Z04	●	4	2	22.5	5	25	100	12	25	SPMG 050204 TGTC UCUNA UYGUNDUR. FOR TGTC INSERT.	3006-M2x4	80-T06
ATSM90-SP..05-D30X5-W25-L100-Z04	●	4	2	30	5	25	100	10	25			
ATSM90-SPGT0502-D63X6-W32-L125-Z10	●	10	5	63	6	32	125	31	30	SPGT 050204		
ATSM90-SPGT0904-D32X14-W32-L120-Z04-H	●	4	2	32	14	32	120	17.5	30	SPGT 090408 ZCC UCUNA UYGUNDUR. FOR ZCC INSERT.	4015-M3.5x9	80-T15
ATSM90-SPGT0904-D37X16-W32-L120-Z04-H	●	4	2	37	16	32	120	21	40			
ATSM90-SPGT0904-D42X17-W32-L120-Z04-H	●	4	2	42	17	32	120	21	40			
ATSM90-SPGT1104-D47X20-W32-L120-Z04-H	●	4	2	47	20	32	120	24	45	SPGT 110408	4015-M4x11	
ATSM90-SP..06-D80X7-W32-L120-Z10	●	10	5	80	7	32	120	32	30	SPMG 060204 TGTC UCUNA UYGUNDUR. FOR TGTC INSERT.	3007-M2.2x5	80-T07

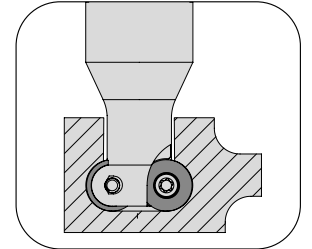
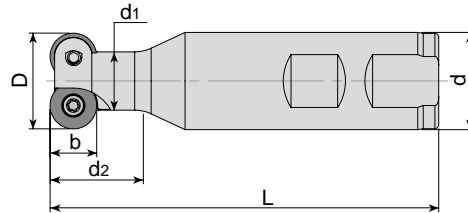

Takım Kodu Ordering Code	Stok Stock	Takım Ölçüleri (mm) Dimension (mm)								Yedek Parçaları Spare Parts		
		Z	D	b	d	L	d ₁	d ₂	Kesici Uç Insert	Sıkma Vidası Screw	Tork Anahtar Torx Key	
ATSMR-RD0702-D17-W16-L90-Z02	●	2	17	7	16	90	10	12	RD.. 0702	3008-M2.5x6	80-T08	
ATSMR-RD0702-D25-W16-L90-Z03	●	3	25	7	16	90	15	12				
ATSMR-RD0702-D35-W25-L100-Z05	●	5	35	7	25	100	20	20				
ATSMR-RD1003-D21-W25-L100-Z02	●	2	21	10	25	100	12	20	RD.. 1003	4015-M3.5x9	80-T15	
ATSMR-RD1003-D80-W32-L165-Z06-H	●	6	80	10	32	165	30	31.5				
ATSMR-RD12T3-D25-W25-L100-Z02	●	2	25	12	25	100	15	24	RD.. 12T3			
ATSMR-RD12T3-D80-W32-L165-Z06-H	●	6	80	12	32	165	30	31.5				
ATSMR-RD1604-D34-W32-L110-Z02	●	2	34	16	32	110	20	30	RD.. 1604	1515-M4.5x11		

R: Sağ/Right L: Sol/Left ● Stokta/In Stock ○ Stokta Yok/Non Stock Item

Sipariş Örneği/Ordering Example : 1 ad./pcs. ATSM90-SP..05-D22.5X5-W25-L100-Z04

Kesme Hesabı : S 271 / Cutting Calculation : P 271

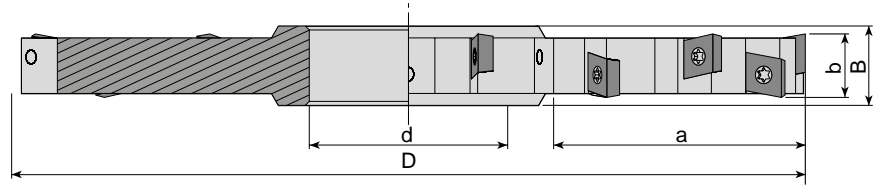

Takım Kodu Ordering Code	Stok Stock	Takım Ölçüleri (mm) Dimension (mm)							Yedek Parçaları Spare Parts		
		Z		D	b	a	d	B	Kesici Uç Insert	Sıkma Vidası Screw	Tork Anahtar Torx Key
		Toplam Total	Etkili Effective								
ASDM-SPGT05-D80x6-d27-Z10	●	10	5	80	6	17	27	10	SPGT 050204 ZCC UCUNA UYGUNDUR. FOR ZCC INSERT.	3006-M2x4	80-T06
ASDM-SPGT05-D100x6-d32-Z12	●	12	6	100	6	25	32	10			
ASDM-SPGT05-D125x6-d40-Z14	●	14	7	125	6	35	40	10			
ASDM-SPGT05-D160x6-d40-Z18	●	18	9	160	6	52	40	10			
ASDM-SPGT06-D80x7-d27-Z10	●	10	5	80	7	17	27	11	SPGT 060204 ZCC UCUNA UYGUNDUR. FOR ZCC INSERT.	3007-M2.2x5	80-T07
ASDM-SPGT06-D100x7-d32-Z12	●	12	6	100	7	25	32	11			
ASDM-SPGT06-D125x7-d40-Z14	●	14	7	125	7	35	40	11			
ASDM-SPGT06-D160x7-d40-Z16	●	16	8	160	7	52	40	11			
ASDM-SPGT06-D200x7-d40-Z18	●	18	9	200	7	70	40	11			

R: Sağ/Right L: Sol/Left ● Stokta/In Stock ○ Stokta Yok/Non Stock Item

Sipariş Örneği/Ordering Example : 1 ad./pcs. ASDM-SPGT05-D80x6-d27-Z10
Kesme Hesabı : S 271 / Cutting Calculation : P 271



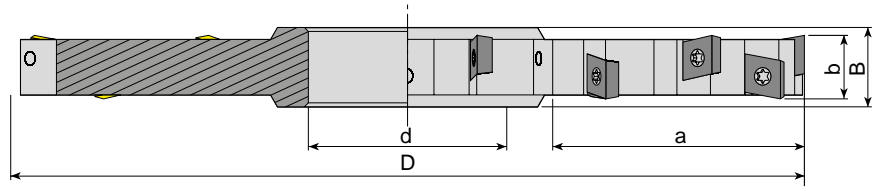

Takım Kodu
Ordering Code

Takım Kodu Ordering Code	Stok Stock	Takım Ölçüleri (mm) Dimension (mm)							Yedek Parçaları Spare Parts		
		Z		D	b	a	d	B	Kesici Uç Insert	Sıkma Vidası Screw	Tork Anahtar Torx Key
		Toplam Total	Etkili Effective								
ASDM-CC06-D80x8-d27-Z10	●	10	5	80	8	17	27	12	CC.. 0602.. ISO UCUNA UYGUNDUR. FOR ISO INSERT.	3008-M2.5x6	80-T08
ASDM-CC06-D100x8-d32-Z12	●	12	6	100	8	25	32	12			
ASDM-CC06-D125x8-d40-Z14	●	14	7	125	8	35	40	12			
ASDM-CC06-D160x8-d40-Z16	●	16	8	160	8	52	40	12			
ASDM-CC06-D200x8-d40-Z18	●	18	9	200	8	70	40	12			
ASDM-CC06-D80x10-d27-Z10	●	10	5	80	10	17	27	14			
ASDM-CC06-D100x10-d32-Z12	●	12	6	100	10	25	32	14			
ASDM-CC06-D125x10-d40-Z14	●	14	7	125	10	35	40	14			
ASDM-CC06-D160x10-d40-Z16	●	16	8	160	10	52	40	14			
ASDM-CC06-D200x10-d40-Z18	●	18	9	200	10	70	40	14			
ASDM-CC09-D80x12-d27-Z08	●	8	4	80	12	17	27	16	CC.. 09T3.. ISO UCUNA UYGUNDUR. FOR ISO INSERT.	4015-M3.5x11	80-T15
ASDM-CC09-D100x12-d32-Z10	●	10	5	100	12	25	32	16			
ASDM-CC09-D125x12-d40-Z12	●	12	6	125	12	35	40	16			
ASDM-CC09-D160x12-d40-Z14	●	14	7	160	12	52	40	16			
ASDM-CC09-D200x12-d40-Z16	●	16	8	200	12	70	40	16			
ASDM-CC09-D80x14-d27-Z08	●	8	4	80	14	17	27	18			
ASDM-CC09-D100x14-d32-Z10	●	10	5	100	14	25	32	18			
ASDM-CC09-D125x14-d40-Z12	●	12	6	125	14	35	40	18			
ASDM-CC09-D160x14-d40-Z14	●	14	7	160	14	52	40	18			
ASDM-CC09-D200x14-d40-Z16	●	16	8	200	14	70	40	18			
ASDM-CC12-D80x16-d27-Z06	●	6	3	80	16	17	27	20	CC.. 1204.. ISO UCUNA UYGUNDUR. FOR ISO INSERT.	1020-M5x11	80-T20
ASDM-CC12-D100x16-d32-Z08	●	8	4	100	16	25	32	20			
ASDM-CC12-D125x16-d40-Z10	●	10	5	125	16	35	40	20			
ASDM-CC12-D160x16-d40-Z12	●	12	6	160	16	52	40	20			
ASDM-CC12-D200x16-d40-Z14	●	14	7	200	16	70	40	20			
ASDM-CC12-D80x18-d27-Z06	●	6	3	80	18	17	27	22			
ASDM-CC12-D100x18-d32-Z08	●	8	4	100	18	25	32	22			
ASDM-CC12-D125x18-d40-Z10	●	10	5	125	18	35	40	22			
ASDM-CC12-D160x18-d40-Z12	●	12	6	160	18	52	40	22			
ASDM-CC12-D200x18-d40-Z14	●	14	7	200	18	70	40	22			
ASDM-CC12-D250x18-d40-Z16	●	16	8	250	18	90	40	22			
ASDM-CC12-D80x20-d27-Z06	●	6	3	80	20	17	27	24			
ASDM-CC12-D100x20-d32-Z08	●	8	4	100	20	25	32	24			
ASDM-CC12-D125x20-d40-Z10	●	10	5	125	20	35	40	24			
ASDM-CC12-D160x20-d40-Z12	●	12	6	160	20	52	40	24			
ASDM-CC12-D200x20-d40-Z14	●	14	7	200	20	70	40	24			
ASDM-CC12-D250x20-d40-Z16	●	16	8	250	20	90	40	24			

R: Sağ/Right L: Sol/Left ● Stokta/In Stock ○ Stokta Yok/Non Stock Item

Sipariş Örneği/Ordering Example : 1 ad./pcs. ASDM-CC06-D80x8-d27-Z10
Kesme Hesabı : S 271 / Cutting Calculation : P 271



A TIP
A TYPE

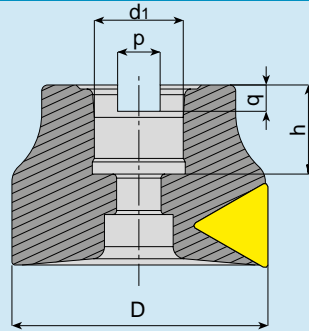

D	d1	d2	p	q	h
40	16	-	8.4	5.6	20
50	22	-	10.4	6.3	22
63	22	-	10.4	6.3	22
80	27	-	12.4	7	25
100	32	-	14.4	8	26

B TIP
B TYPE

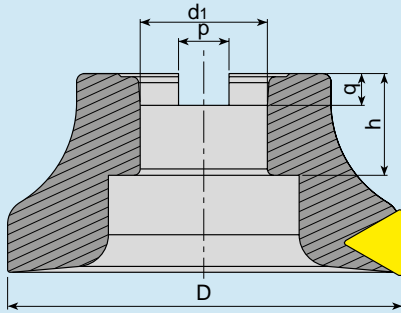

D	d1	d2	p	q	h
125	40	-	16.4	9	32

C TIP
C TYPE

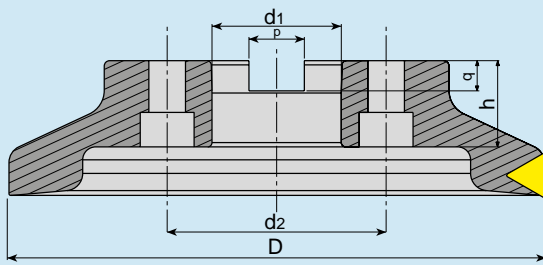

D	d1	d2	p	q	h
160	40	66.7	16.4	9	32
200	60	101.6	25.7	14	40
250	60	101.6	25.7	14	40

D TIP
D TYPE

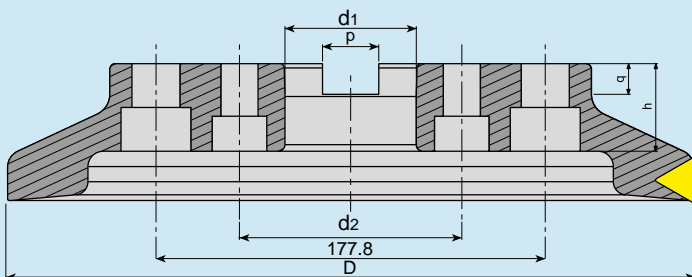

D	d1	d2	p	q	h
315	60	101.6	25.7	14	40

TAKMA UÇLU MATKAP (U-DRILL) KULLANMA KILAVUZU

Matkabınızı CNC torna tezgahına bağlamadan önce taretin merkezden kaçık olup olmadığını kontrol etmeniz gerekir. Şayet taretinizde kaçıklık varsa, takma uçlu matkabınızı kesinlikle kullanmayınız. Taretin düzeltilmesi için yapılması gereken işlemler ;

1. Taretin tutucusuna kullanacağınız takma uçlu matkabın çapında ve boyunda üzeri hassas olan silindirik bir parça bağlanır ve tezgahın X değeri sıfıra getirilir.
2. Tezgahın aynasına mıknatıslı komprotör saati yerleştirilir. Saatin uç kısmı tarete bağlanmış olduğumuz parçanın üstüne temas ettirilir.
3. Aynanın üzerine bağlanmış olduğumuz mıknatıslı komprotör ayna ile beraber 360 derece döndürülerek saatteki değişim oranına göre taretin sıfırlanması sağlanır.

TAKMA UÇLU MATKABINIZI CNC TORNANIZDA DAHA VERİMLİ KULLANMANIZ İÇİN GEREKLİ OLAN KESME HIZLARI ve DEVİRLERİ :

Grup No.	Malzemenin Cinsi	Malzemenin Öz.	Kesme Hızı Vc (m/dk)
1	Çok Yumuşak İş Çelikleri	C1010, Otomat vb.	220
2	İmalat Çelik ve Döküm Malz.	C1030 - 106 vb.	200
3	Takım ve İmalat Çeşitleri	CK-45, 4140, 7131 vb.	170
4	Sıcak İş ve Paslanmaz Çelikler	İmpaks vb.	150

Devir hesabı yapabilmek için önce malzemeyi seçiniz. Seçtiğiniz malzemenin kesme hızını (Vc) 1000 ile çarpıp 3.14'e bölmeliyiz. Çıkan değeri matkap çapına bölmeliyiz. **ÖRNEK** : Malzememiz takım ve imalat çeliği (3. grup), matkap çapı 25 mm kesme hızı 170 ise $170 \times 1000 = 170000 / 3.14 = 54140$, $54140 / 25 = 2166$ devir çıkar (Tezgahın İş Mili Devri). Tezgahın ilerlemesi kullanacağınız uç ile de alakalı olup 0.05 ile 0.10 arasında değişim gösterir. Kullanıcı kesici ucun kesişine göre bunu ayarlar.

İŞLEME MERKEZLERİ İÇİN İLERLEME HESABI :

Yukarıdaki hesaplamalarla bulmuş olduğunuz 2166 iş mili devrini, kesici uç ilerlemesi (mm/devir) 0.05 ile 0.10 arasındaki ilerleme seçenekleri ile çarpılır. **ÖRNEK 1** : $2166 \times 0.05 = 108$ **ÖRNEK 2** : $2166 \times 0.10 = 217$ çıkan sonuçlar 108 ve 217 işleme merkezleri için ilerleme mm/dakika hesabıdır.

Not: D4 ve üzeri takma uçlu matkaplarda tezgahın içten su verme basıncının en az 6 bar olması gerekmektedir.

USER'S GUIDE FOR AKKO U-DRILLS

Before connecting your U-Drill to CNC lathe, you have to check if the turret is eccentric from the center or not. If there is any eccentricity in your turret, never use your U-Drill;

Processes that should be done to fix the turret :

1. A cylindrical part whose surface is precision and whose length and diameter is the same with the U-Drill that you will use, should be mounted to the holder of turret and X value of the lathe should be brought to zero (0).
2. Comparator should be mounted to chuck. The end of the comparator should be contacted (touched) to the surface of the part that we mounted on the turret.
3. The comparator that we mounted on the chuck should be turned 360-degree with the chuck and turret should be zeroed by that turning according to changing rate of comparator.

CUTTING SPEED AND REVOLUTION THAT ARE NEEDED FOR USING (RUNNING) YOUR U-DRILLS MORE PRODUCTIVELY

Grup No.	Material	Material Type	Cutting Speed Vc (m/m)
1	Non-alloy steel and free cutting steel	C1010. Automat etc.	220
2	Low alloy steel and cast steel	C1030 - 106 etc.	200
3	Alloy steel and tool steel	CK-45, 4140, 7131 etc.	170
4	Hot Work Steel and Stainless Steel	Impax etc.	150

P.S. : The cutting speed may be concerned with the type of the insert that you use.

Fistly, choose the material to make calculation of revolution. You should multiply the cutting speed (Vc) of the material that you chose by 1000 and divide by 3.14. You should divide the value that you found by the diameter of U-Drill. For Example : If our material is alloy steel and tool steel (3rd group), diameter of the U-Drill is 25 mm, cutting speed is 170, we should calculate as following; $170 \times 1000 = 170000 / 3.14 = 54140$, $54140 / 25 = 2166$ rpm is the result that we found (Spindle Speed) Feed rate of the lathe is concerned with the U-Drill that you will use and changes between 0.05 and 0.10. The user sets it according to cut of cutting insert.

FEED CALCULATION FOR CENTRAL MACHINE :

2166 spindle speed, that we found as a result of above mentioned calculation, should be multiplied by cutting insert feed (mm/r) between 0.05 and 0.10 feed choisses. Example 1 : $2166 \times 0.05 = 108$

Example 2 : $2166 \times 0.10 = 217$ The results 108 and 217 are the feed mm/m calculation for central machine.

Note: Cooling water pressure of lathe must be minimum 6 bar for our D4 u-drills and u-drills longer than D4.

FREZELEME İŞLEMİNDE DEVİR ve İLERLEME HESABI

Vc.	S	D	F	Z	fz	FORMÜLLER
Kesme Hızı (Uç Kutusunun Arkasından Okuyunuz)	İş Mili Devir Sayısı	Tarama Kafası Çapı	İlerleme	Tarama Kafası Ağız Sayısı	Diş Başına Düşen İlerleme Miktarı (Uç Kutusunun Arkasından Okuyunuz)	Devir Hesabı : $S=(Vc \times 1000) / (3,14 \times D)$ İlerleme Hesabı : $F=S \times Z \times fz$

Örnek : D=50 mm çapında, Z=5 ağızlı tarama kafası ile frezeleme yapacağız. Kesici uç kutusunun arkasında kesme hızı Vc=200m/dk. olarak verilmiş olsun. Tezgaha girilecek devri hesaplayalım: **Vc=200 m/dk. D=50 mm** S = Öncelikle Kesme Hızı 1000 ile çarpılır, çıkan sonuç 3,14 sayısına bölünür, buradan çıkan sonuç da tarama kafası çapına bölünür.

$S=200 \times 1000 = 200000 \rightarrow 200000/3,14=63663 \rightarrow 63663/50=1273$ devir **S=1273 dev/dakika** devri bulduktan sonra ilerlemeyi bulalım : **Z=5** ağızlı tarama kafası olsun **fz=0,12** olarak uç kutusunun arkasından okunmuş olsun F= yukarıda bulmuş olduğumuz devir sayısı ile ağız sayısı çarpılır, çıkan sonuç diş başına düşen ilerleme miktarı ile çarpılır.

$F=1273 \times 5 = 6365 \rightarrow 6365 \times 0,12 = 763$ $F=763$ mm/dakika

Tezgaha girilecek olan devir = S 1273 Tezgaha girilecek olan ilerleme : **F 763 ortalama değerdir.**

Not: Vc ve fz değerlerinin uç kutusunun arkasında verilmiş olması gerekir. Eğer bu değerler uç kutusunun üzerinde yoksa, kesici ucun katalogundan bulunuz. İşleyeceğiniz malzeme çelik ise P, paslanmaz çelik ise M, dökme demir ise K bölümünde yazılı olan Vc ve fz değerlerini okuyun.

CALCULATING SPINDLE SPEED and FEED RATE FOR MILLING PROCESS

Vc.	S	D	F	Z	fz	FORMULAS
Cutting Speed (Please read from the back- side of cutting insert box)	Spindle Revolution rpm	Milling Tool Diameter	Feed Rate	Number of Effective Tooth	Feed Per Tooth (Please Read From The Back Side of Cutting Insert Box)	Calculation of Revolution : $S=(Vc \times 1000) / (3,14 \times D)$ Feed Rate Calculation : $F=S \times Z \times fz$

For Example : We will make milling with milling tool whose diameter is D 50 mm, whose teeth number is Z=5. The spindle revolution was written as Vc=200m/mn at the back side of cutting insert box. Let's calculate the revolution that should be entered to the milling machine : Vc=200 m/mn D=50 mm

S = Firstly Cutting Speed is multiplied with 1000, the result should be divided by 3.14 , the last result should be divided by diameter of milling tool.

$S = 200 \times 1000 = 200000 \rightarrow 200000/3,14 = 63663 \rightarrow 63663/50 = 1273$ rev S=1273 rev / mn

After finding spindle revolution, let's find feed rate : milling tool with Z=5 teeth and we read fz=0,12 from the back side of cutting insert box.

F = Tooth number should be multiplied with revolution, the result should be multiplied with feed per tooth.

$F = 1273 \times 5 = 6365 \rightarrow 6365 \times 0,12 = 763$ F = 763 mm / mn

Revolution that should be entered to the milling machine = S 1273 Feed Rate that should be entered to the milling machine = F 763 average value.

P.S : The values Vc and fz has to be written at the back side of the cutting insert. If these values were not written on the cutting insert box, please find them from cutting insert catalogue. If the material that you will work is steel, please read Vc and fz values that were written on the part P, if it is stainless steel please read from the part M, if it is cast iron please read from the part K.

SIKMA TORKU TAVSİYELERİ - RECOMMENDED TIGHTENING TORQUE

• Takımı Sıkmadan Önce Aşağıdaki Bilgileri Okuyunuz.

• Read below information before tightening the tool.

• Vidalı Takımın Vida Ölçüsü ile Tutucunun İç Vida Ölçüsünü Sıkmadan Önce Kontrol Ediniz.

• Check screw set's the screw size and together with mounting arbor inner dimension of screws.

Takımı Tutucuya Sıkarken Tablodaki İlgili Değerlere Göre İşlem Yapınız.

When tightening head to an arbor, follow the related tightening torque in the table.

Vida Screw	Tork Torque (N.m)
M6	8
M8	23
M10	46
M12	80
M16	90

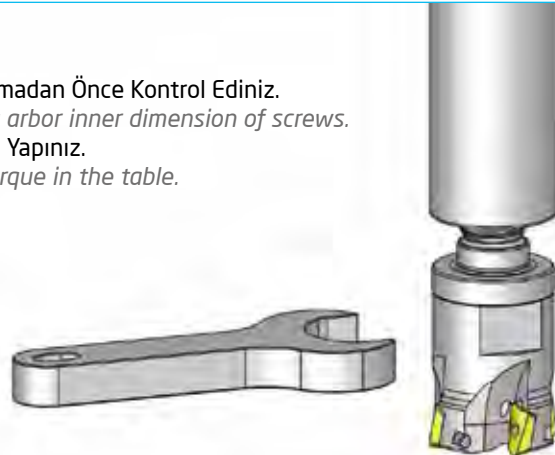

Gövde Malzemesine Göre Delik İçi Kater Uygulama Kılavuzu

Internal Boring Bars Application Guide, Related to Body Material

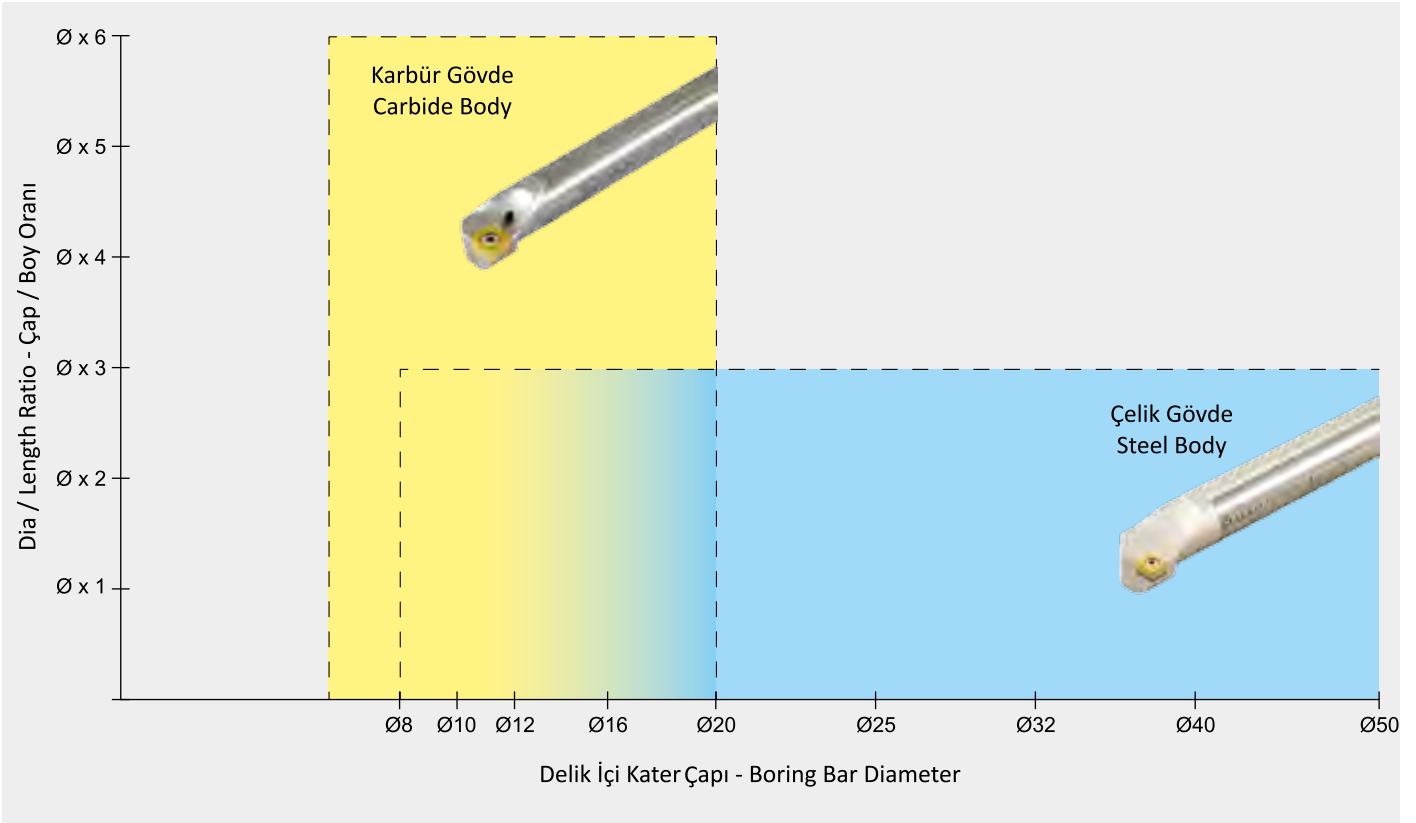

T Kanal Freze Kullanım ve Ön Hazırlama Kılavuzu

Application Guide For T-Slot Milling

T kanal frezelemede talaşın rahat boşaltılması için iş parçası resimde gösterildiği şekilde işlenmelidir.

Örnek: ATSM90-CC06- D32X10-W25- L100-Z04 kodlu T freze ile kanal açmadan önce, takımın boğazının çalışacağı kısmın parmak freze ile işlenmesi gerekir. Bu durumda kanalın tamamen işlenmesi çok yanlıştır. Tabanda ($0.8 \times b = 0.8 \times 10$) 8mm işlenmeden bırakılmalıdır. Bu bölgeyi T frezenin işlemesi, takımın daha sağlıklı çalışması açısından gereklidir.

İşlenen kanallarda yumuşak kesim için talaşlar uzaklaştırılmış olmalıdır.

When T slot machining steel, the workpiece must be machined as shown in the drawing to ensure smooth chip evacuation.

Example: Before slotting with the T - slot milling cutter - code ATSM90-CC06-D32X10-W25-L100-Z04,

The area of the neck of the tools to be worked and must be machined by End-Mill.

In this case, it is very wrong to machining the slot completely.

Bottom area ($0.8 \times b = 0.8 \times 10$) should be left 8 mm without machining.

This area's operation must be machined by the T - slot milling cutter which is also necessary for the healthier work of the tool holder.

Slots to be machined must be free from chips for smooth machining.

KULLANIM İÇİN UYARI CAUTION FOR USE

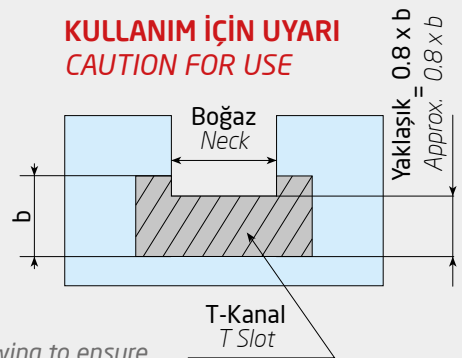

α = 5 Kat Dayanıklılık **α = 5 Times Long Life**

Alfa Kaplamanın Avantajları

Alpha Coating Advantages

- **Yüksek aşınma direnci**
High resistance to abrasion
- **Yüksek yüzey sertliği**
750-800 Vickers
High surface hardness
750-800 Vickers
- **Temperlemeye karşı yüksek direnç**
High resistance to tempering
- **Yüksek yorulma mukavemeti**
High fatigue strength
- **Yüksek çizik ve çentik direnci**
High scratch and impact resistance
- **Paslanmaz olmayan çelikler için daha yüksek korozyon direnci**
Resistant to corrosion of non-stainless steel

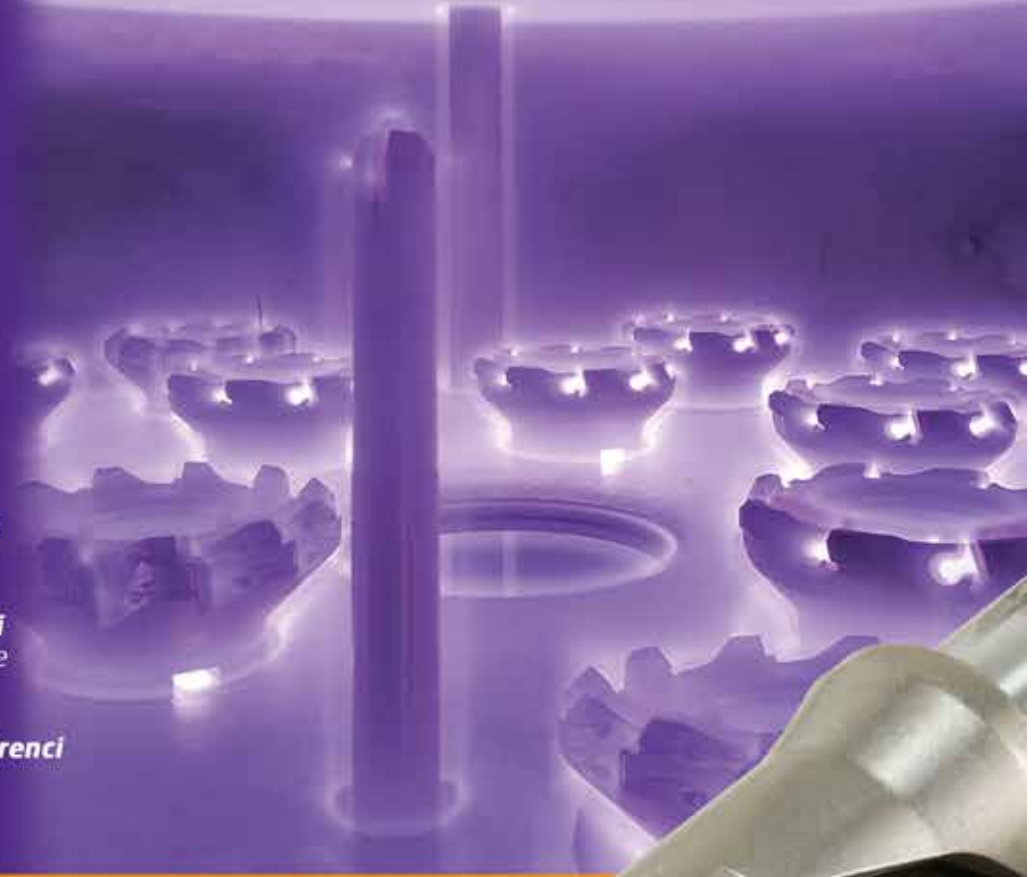

takımınız neden
daha uzun ömürlü
olmasın?...

longer tool life...



α Çevre Dostudur. α is friend of environment.

İnsan sağlığı açısından zararlı değildir. Is not harmful to human health.

Gaz ve diğer atıkları çevreyi kirlilemez. Gas and other wastes will not pollute the environment.

ALTLIKLAR / SHIMS

ÜRÜN RESMİ/PICTURE	ÜRÜN KODU/CODE	ÜRÜN DETAYI / PRODUCT DETAIL
	AATN-2-0001	S-SİSTEM için / For S-SYSTEM
	AATN-2-0002	T-M SİSTEM için / For T-M SYSTEM
	AATN-3-0025	C-SİSTEM için / For C-SYSTEM
	AATN-3-0015	P-SİSTEM için / For P-SYSTEM
	AATN-2-0020	T-M-P SİSTEM için / For T-M SYSTEM
	AATN-2-0004	DİŞ VİDA 16 ALTLIK / For THREADING 16 SHIM
	ATS-16E	DİŞ VİDA 22 ALTLIK / For THREADING 22 SHIM
	ATS-16I	DİŞ VİDA 16, DİŞ ÇAP SAĞ - DELİK İÇİ SOL ALTLIK / For THREADING SYSTEM 16 SHIM, EXTERNAL RIGHT-INTERNAL LEFT
	ATS-22E	DİŞ VİDA 16, DİŞ ÇAP SOL - DELİK İÇİ SAĞ ALTLIK / For THREADING SYSTEM 16 SHIM, EXTERNAL LEFT-INTERNAL RIGHT
	ATS-22I	DİŞ VİDA 22, DİŞ ÇAP SAĞ - DELİK İÇİ SOL ALTLIK / For THREADING SYSTEM 22 SHIM, EXTERNAL RIGHT-INTERNAL LEFT
	ATS-27E	DİŞ VİDA 22, DİŞ ÇAP SOL - DELİK İÇİ SAĞ ALTLIK / For THREADING SYSTEM 22 SHIM, EXTERNAL LEFT-INTERNAL RIGHT
	ATS-27I	DİŞ VİDA 27, DİŞ ÇAP SAĞ - DELİK İÇİ SOL ALTLIK / For THREADING SYSTEM 27 SHIM, EXTERNAL RIGHT-INTERNAL LEFT
	AACN-2-0001	DİŞ VİDA 27, DİŞ ÇAP SOL - DELİK İÇİ SAĞ ALTLIK / For THREADING SYSTEM 27 SHIM, EXTERNAL LEFT-INTERNAL RIGHT
	AACN-2-0002	S-SİSTEM için / For S-SYSTEM
	AACN-2-0002	T-SİSTEM için / For T-SYSTEM
	AACN-2-0003	P-SİSTEM için / For P-SYSTEM
	AACN-3-0001	S-SİSTEM için / For S-SYSTEM
	AACN-3-0002	C-SİSTEM için / For C-SYSTEM
	AACN-3-0001	T-M-P SİSTEM için / For T-M-P SYSTEM
	AACN-3-0002	C-SİSTEM için / For C-SYSTEM
	AACN-3-0002	T-P SİSTEM için / For T-P SYSTEM
	AACN-3-0003	T-P SİSTEM için / For T-P SYSTEM
	AACN-3-0008	T-P SİSTEM için / For T-P SYSTEM
	AAWN-2-0003	T-M-P SİSTEM için / For T-M-P SYSTEM
	AAWN-3-0001	T-M-P SİSTEM için / For T-M-P SYSTEM
	AAWN-SW317	T-M-P SİSTEM için / For T-M-P SYSTEM
	AKS-16L	C-SİSTEM için / For C-SYSTEM
	AKS-16R	C-SİSTEM için / For C-SYSTEM
	AASD-3-0001	C-SİSTEM için / For C-SYSTEM
	AASE-3-0001	S-SİSTEM FREZELEME için / For S-SYSTEM MILLING
	AASE-3-0001	S-SİSTEM FREZELEME için / For S-SYSTEM MILLING
	AASN-2-0001	S-SİSTEM için / For S-SYSTEM
	AASN-2-0001	S-SİSTEM için / For S-SYSTEM
	AASN-2-0002	P-SİSTEM için / For P-SYSTEM
	AASN-2-0004	S-SİSTEM için / For S-SYSTEM
	AASN-3-0004	T-P SİSTEM için / For T-P SYSTEM
	AASN-3-0004	C-SİSTEM için / For C-SYSTEM
	AASN-3-0023	T-P SİSTEM için / For T-P SYSTEM
	AASN-3-0005	T-P SİSTEM için / For T-P SYSTEM
	AASN-3-0020	T-P SİSTEM için / For T-P SYSTEM
	AASN-20020	PSDNN KARTUŞ için / For PSDNN CARTRIDGE
	AADN-2-0001	S-SİSTEM için / For S-SYSTEM
	AADN-2-0001	T-SİSTEM için / For T-SYSTEM
	AADN-SD317	P-SİSTEM için / For P-SYSTEM
	AADN-3-0001	T-M-P SİSTEM için / For T-M-P SYSTEM
	AADN-2-0003	C-SİSTEM için / For C-SYSTEM
	AADN-2-0003	T-SİSTEM için / For T-SYSTEM
	AAVN-2-0002	S-SİSTEM için / For S-SYSTEM
	AAVN-2-0002	T-SİSTEM için / For T-SYSTEM
	AARC-3-0001	C-SİSTEM için / For C-SYSTEM
	AARC-3-0002	C-SİSTEM için / For C-SYSTEM
	AARC-3-0003	C-SİSTEM için / For C-SYSTEM
	AARC-3-0003	C-SİSTEM için / For C-SYSTEM
	AARC-3-0003	C-SİSTEM için / For C-SYSTEM



BASKI PABUÇLARI / CLAMPS

ÜRÜN RESMİ/PICTURE	ÜRÜN KODU/CODE	ÜRÜN DETAYI / PRODUCT DETAIL	
	ATK-01	T-SİSTEM için / For T-SYSTEM	DNMG 11, WNMG 06, TNMG 16, CNMG 09 BASKI PABUCU / CLAMP
	ATK-02	T-SİSTEM için / For T-SYSTEM	CNMG 12, WNMG 08, TNMG 22, DNMG 15, SNMG 12 BASKI PABUCU / CLAMP
	ATK-03	T-SİSTEM için / For T-SYSTEM	VNMG 16 BASKI PABUCU / CLAMP
	ATK-04	T-SİSTEM için / For T-SYSTEM	CNMG 16, SNMG 15 BASKI PABUCU / CLAMP
	AMK-01	M-SİSTEM için / For M-SYSTEM	WNMG 06 BASKI PABUCU / CLAMP
	AMK-02	M-SİSTEM için / For M-SYSTEM	DELİK İÇİ / INTERNAL Ø20 TNMG 16 Ø25 MT-NR/L 16 BASKI PABUCU / CLAMP
	AMK-03	M-SİSTEM için / For M-SYSTEM	DNMG 11, CNMG 12 BASKI PABUCU / CLAMP
	AMK-04	M-SİSTEM için / For M-SYSTEM	DNMG 15, TNMG 16-22 BASKI PABUCU / CLAMP
	AMK-05	M-SİSTEM için / For M-SYSTEM	WNMG 08 BASKI PABUCU / CLAMP
	AMK-07	M-SİSTEM için / For M-SYSTEM	S20R MCLNR/L BASKI PABUCU / CLAMP
	ACK-01-R	C-SİSTEM için / For C-SYSTEM	KNUX-R BASKI PABUCU / CLAMP
	ACK-02-L	C-SİSTEM için / For C-SYSTEM	KNUX-L BASKI PABUCU / CLAMP
	ACK-03	C-SİSTEM için / For C-SYSTEM	154.91 DIŞ ÇAP ve DELİK İÇİ / EXTERNAL and INTERNAL Ø25-Ø32 BASKI PABUCU / CLAMP
	ACK-04	P-C SİSTEM için / For P-C SYSTEM	CTFPR KARTUŞ BASKI PABUCU / CARTRIDGE CLAMP
	ACK-05	P-C SİSTEM için / For P-C SYSTEM	FREZELEME ve DIŞ VIDA AÇMA TAKIMLARINA GÖRE İLAVE BASKI PABUCU ADDITIONAL LITTLE CLAMP for MILLING and THREADING CLAMP
	ACK-06	C-SİSTEM için / For C-SYSTEM	154.91 DELİK İÇİ / INTERNAL Ø16-Ø20 BASKI PABUCU / CLAMP
	ACK-07	C-SİSTEM için / For C-SYSTEM	SERAMİK CNGN, SNGN, DNGN YEDEK TAKIMI SPARE PART SET of CERAMIC CNGN, SNGN, DNGN
	ACK-08	C-SİSTEM için / For C-SYSTEM	SERAMİK TNGN, YEDEK TAKIMI SPARE PART SET of CERAMIC TNGN
	ACK-09	P-SİSTEM için / For P-SYSTEM	CNMG 16-19, SNMG 15-19 İLAVE BÜYÜK BASKI PABUCU ADDITIONAL BIG CLAMP
	ACK-10	C-SİSTEM FREZELEME için For C-SYSTEM MILLING	SPKN 12 ve Ø50-Ø63 TPKN 16 BASKI PABUCU / CLAMP (M8x8)
	ACK-11	C-SİSTEM FREZELEME için For C-SYSTEM MILLING	Ø80-Ø100 TPKN 16-TPKN 22, OFKR 07, HNMX 09 BASKI PABUCU / CLAMP (M8x10)
	ACK-12	C-SİSTEM için For C-SYSTEM	CTSPR KARTUŞ BASKI PABUCU / CARTRIDGE CLAMP
	ACK-15	S-SİSTEM FREZELEME için For S-SYSTEM MILLING	RD.. 10-12 BASKI PABUCU / CLAMP
	ACK-19	S-SİSTEM FREZELEME için For S-SYSTEM MILLING	WD0805D BASKI PABUCU / CLAMP
	ACK-23	C-SİSTEM için / For C-SYSTEM	SERAMİK DNGN 11, YEDEK TAKIMI SPARE PART SET of CERAMIC DNGN 11
	ACK-24	S-SİSTEM FREZELEME için For S-SYSTEM MILLING	XD0806D BASKI PABUCU / CLAMP
	ACK-27	C-SİSTEM için / For C-SYSTEM	RCGX 06 BASKI PABUCU / CLAMP
	ACK-28	C-SİSTEM için / For C-SYSTEM	RCGX 09 BASKI PABUCU / CLAMP
	ACK-29	C-SİSTEM için / For C-SYSTEM	RCGX 12 BASKI PABUCU / CLAMP

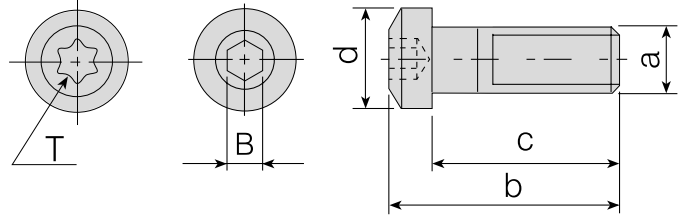

BASKI PABUÇ VİDALARI / CLAMP SCREWS

Takım Kodu Ordering Code	a (M)	b	c	d	B(T)	Ürün Detayı Product Detail
AKV-01-M5X22	M5x0.8	25.1	22	11	3	T-SİSTEM için / For T- SYSTEM DNMG 11, WNMG 06, TNMG 16
AKV-02-M6X22	M6x1.0	25.3	22	11	3	T-SİSTEM için / For T- SYSTEM CNMG 12, WNMG 08, TNMG 22, DNMG 15, SNMG 12, VNMG 16
						M-SİSTEM için / For M- SYSTEM TNMG 16, TNMG 22
AKV-03-M6X22	M6x1.0	25.3	22	10	3	KANAL KATERİ için / For EXTERNAL GROOVING 2mm Dış Çap Kanal Kater Vidası / External Grooving Tools Screw
						M-SİSTEM için / For M- SYSTEM WNMG 08
AKV-04-M5X17	M5x0.8	20	17	8.5	3	M-SİSTEM için / For M- SYSTEM S20R MT-NR/L 16, S20R-S25S MWLNR/L 06, S25S MDUNR/L 11-Dış Çap / External MWLNR 06
AKV-05-M6X25	M6x1.0	29.5	25	13.8	4	T-SİSTEM için / For T- SYSTEM Eski Ürün Vidası / Old Products Screws CNMG 16, SNMG 15
AKV-06-M6X20	M6x1.0	26.5	20	10.6	4	C-SİSTEM için / For C-SYSTEM KNUX 16
AKV-07-M6X22	M6x1.0	23.5	22	8.5	3	C-SİSTEM için / For C-SYSTEM ADKT-154.91, AIKT-154.91-R/L-32
AKV-10-M6X14	M6x1.0	16	14	8.8	4	C-SİSTEM için / For C-SYSTEM AIKT-154.91-R/L-16, AIKT-154.91-R/L-20, AIKT-154.91-R/L-25
AKV-11-M8X29	M8x1.25	33.6	29	11	4	C-SİSTEM için / For C-SYSTEM TNGN 16, CNGN 12, DNGN 15, SNGN 12
AKV-17-M5X15	M5x0.8	18	15	8.55	3	M-SİSTEM için / For M- SYSTEM S16P MWLNR/L 06
AKV-19-M7X25	M7x1.0	29.6	25	14	4	T-SİSTEM için / For T- SYSTEM Yeni / New CNMG 16, SNMG 15
AKV-20-M6X19	M6x1.0	22	19	11	3	M-SİSTEM için / For M- SYSTEM S25S MDUNR/L 15
AKV-21-M6X18	M6x1.0	20	18	8.5	3	C-SİSTEM için / For C-SYSTEM AIKT-154.91-R/L-25
AKV-23-M4X10	M4x0.7	12.2	10	7.4	15	KARTUŞ için / For CARTRIDGE MONTAJ VİDASI / MOUNTING SCREW
AKV-27-M6X20	M6x1.0	23.3	20	10	3	M-SİSTEM için / For M- SYSTEM S25S MWLNR/L 08

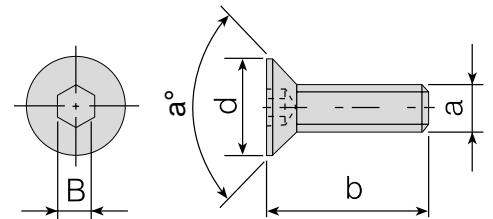

ALTLIK VİDALARI / SHIM SCREWS

Takım Kodu Ordering Code	a (M)	b	d	B	a°	Ürün Detayı Product Detail
AAV-01-M3x10	M3x0.5	10	5.9	2	90°	T-SİSTEM için / For T-SYSTEM WNMG 06, KNUX 16
AAV-02-M5X12	M5x0.8	12	7	3	56°	T-SİSTEM için / For T-SYSTEM CNMG 12, WNMG 08, TNMG 22, DNMG 15, SNMG 12
AAV-05-M6X15	M6x1.0	16	9	4	60°	T-SİSTEM için / For T-SYSTEM CNMG 16, SNMG 15
AKV-12-M5X12	M5x0.8	12	7.8	3	90°	C-SİSTEM için / For C-SYSTEM CTSPR Baskı Pabuç Vidası / Clamp Screw
AKV-16-M6X16	M6x1.0	16	10	4	76°	C-SİSTEM için / For C-SYSTEM CTFPR 13CS 16 Baskı Pabuç Vidası / Clamp Screw
AAV-13-M5X8	M5x0.8	8	7	3	56°	T-SİSTEM için / For T-SYSTEM S25S TSKNR/L 12, S25S TCLNR/L 12, S25S TWLNR/L 08, S25S TDUNR/L 15
AAV-14-M5X14	M5x0.8	14	8.8	3	45°	ADCR için / For ADCR ADCR Montaj Vidası / Mounting Screw

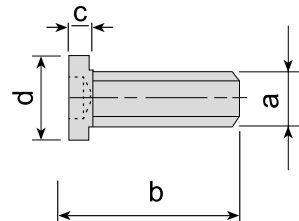
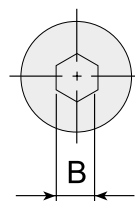

ALTLIK VİDALARI / SHIM SCREWS

Takım Kodu Ordering Code	a (M)	b	c	d	B	Ürün Detayı Product Detail	
						T-SİSTEM için / For T-SYSTEM	C-SİSTEM için / For C-SYSTEM
AAV-03-M5X12	M5X0.8	12	1.4	6	3	T-SİSTEM için / For T-SYSTEM	TNMG 16
						C-SİSTEM için / For C-SYSTEM	TNGN 16
AAV-04-M5X12	M5X0.8	12	1.2	6.5	3	T-SİSTEM için / For T-SYSTEM	VNMG 16, DNMG 11, CNMG 09
AAV-09-M5X9	M5X0.8	9	1.4	6	3	T-SİSTEM için / For T-SYSTEM	S25S TCLNR/L 09, S25S TDUNR/L 11, S25S TDQNR/L 11

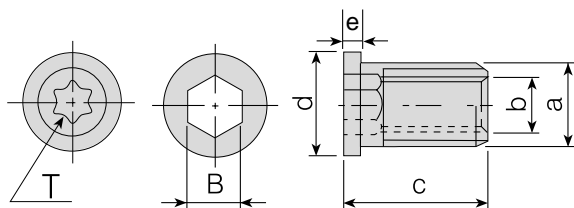

BUKSE VİDALAR / BUKSE SCREWS

Takım Kodu Ordering Code	a (M)	b	c	d	B(T)	e	Ürün Detayı Product Detail	
							S-SİSTEM için / For S- SYSTEM	Other Details
AAV-06-M3.5X11	M5x0.5	M3.5x0.6	11.3	6	3.5	1.2	S-SİSTEM için / For S- SYSTEM	CCMT 09, DCMT 11, VBMT 16, VCMT 16, TCMT 16, SCMT 09, 16 ER/L, 16 IR/L
AAV-07-M4.5X13	M6X0.75	M4.5X0.75	13	7.5	4.5	1.6	S-SİSTEM için / For S- SYSTEM	CCMT 12, SCMT 12, 22 ER/L, 22 IR/L
AAV-08-M3.5X8	M5X0.5	M3.5x0.6	8	6	20	1.2	S-SİSTEM için / For S- SYSTEM	Ø25 DCMT 11, Ø25-Ø32 CCMT 09, Ø25 TCMT 16, S25S-S32T SVJBR/L 16,
AAV-10-M4.5X8	M6X0.75	M4.5X0.75	8	7.5	4.5	1.05	S-SİSTEM için / For S- SYSTEM	Ø25-Ø32 CCMT 12, Ø25-Ø32 SCMT 12, SSSCN 1616 H12, SSSCR/L 1616 H12, SIR/L S25R 22
AAV-16-M3.5X8	M5X0.5	M3.5x0.6	8	6	20	1.1	S-SİSTEM için / For S- SYSTEM	SEMT 13

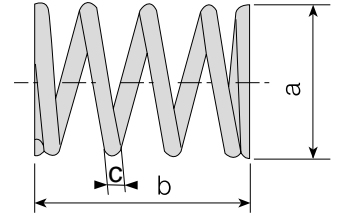
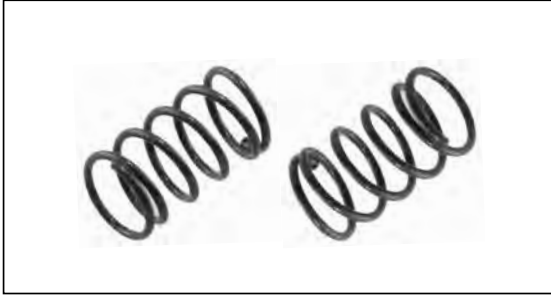

BASKI YAYI / CLAMP SPRING

Takım Kodu Ordering Code	BASKI YAYI / CLAMP SPRING			Ürün Detayı Product Detail	
	a	b	c		
AKY-01	7.7	11.2	0.9	T-SİSTEM için / For T-SYSTEM	CNMG 12, WNMG 08, TNMG 22, DNMG 15, SNMG 12, VNMG 16
AKY-02	8.5	13.5	0.7	C-SİSTEM için / For C-SYSTEM	KNUX 16

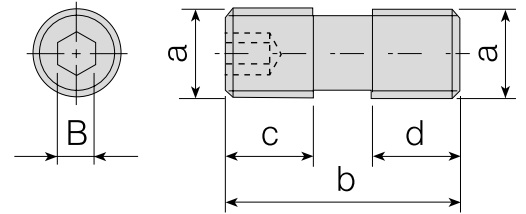

BASKI PABUÇ VİDALARI / CLAMP SCREWS

Takım Kodu Ordering Code	BASKI PABUÇ VİDALARI / CLAMP SCREWS						Ürün Detayı Product Detail	
	a (M)	b	c	d	B			
AKV-13-M8X1X16	M8x1.0	16	6.8	6.8	4	C-SİSTEM FREZELEME için / MILLING For C-SYSTEM	SPKN 12 ve Ø63 TPKN 16	
AKV-14-M8X1X18	M8x1.0	18	8	8	4	C-SİSTEM FREZELEME için / MILLING For C-SYSTEM	Ø80-Ø100 TPKN 16 ve Ø63-Ø315 TPKN 22	
AKV-15-M8X1X20	M8x1.0	20	8.5	8.5	4	C-SİSTEM FREZELEME için / MILLING For C-SYSTEM	OFKR 07, HNMX 09	
AKV-18-M5X14	M5x0.8	15	5	6.8	2.5	C-SİSTEM FREZELEME için / MILLING For C-SYSTEM	SN19	
AKV-22-M8X1X14	M8x1.0	14	6.8	4.8	4	C-SİSTEM FREZELEME için / MILLING For C-SYSTEM	Ø50 TPKN 16	

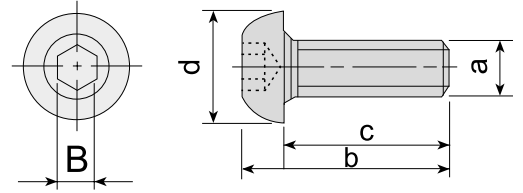

KANAL KATER ve MANTAR VİDALAR / GROOVING TOOL and CLAMP SCREWS

Takım Kodu Ordering Code	a (M)	b	c	d	B	Ürün Detayı Product Detail	
1904-M8X1X20	M8X1.0	25.9	20	11.3	4	S-SİSTEM için / For S- SYSTEM	RCMT 32 Sıkma Vidası / Clamp Screw
2004-M8X1X20	M8X1.0	25.9	20	11.4	4	KANAL KATERİ için / For EXTERNAL GROOVING	Kanal Kater Vidası / External Grooving Tools Screw
2004-M8X20	M8X1.25	30	25	25	4	KANAL KATERİ için / For EXTERNAL GROOVING	Eski Kanal Kater Vidası / Old External Grooving Tools Screw
AKV-08-M6X12	M6x1.0	17	12	14.3	4	C-SİSTEM FREZELEME için / MILLING For C- SYSTEM	Baskı ve Sıkma Vidası, Mantar Vida / Clamp Screw
AKV-09-M8X18	M8X1.0	24	18	17.2	5	C-SİSTEM FREZELEME için / MILLING For C- SYSTEM	Baskı ve Sıkma Vidası, Mantar Vida / Clamp Screw

LEVYELER / LEVERS

Ürün Resmi Product Picture	Ürün Kodu Product Code	Ürün Detayı Product Detail	
	APL-01	P-SİSTEM için / For P-SYSTEM	CNMG 09, DNMG 11, SNMG 09, TNMG 16, WNMG 06 LEVYESİ / LEVER
	APL-02	P-SİSTEM için / For P-SYSTEM	CNMG 12, SNMG 12, TNMG 22, WNMG 08 LEVYESİ / LEVER
	APL-03	P-SİSTEM için / For P-SYSTEM	DNMG 15 LEVYESİ / LEVER
	APL-04	P-SİSTEM için / For P-SYSTEM	CNMG 16, SNMG 15 LEVYESİ / LEVER
	APL-05	P-SİSTEM için / For P-SYSTEM	CNMG 19, SNMG 19 LEVYESİ / LEVER
	APL-06	P-SİSTEM için / For P-SYSTEM	CNMG 25, SNMG 25 LEVYESİ / LEVER
	APL-07	P-SİSTEM için / For P-SYSTEM	S16P PCLNR/L 09 LEVYESİ / LEVER
	APL-08	P-SİSTEM için / For P-SYSTEM	S16P PTUNR/L 16 LEVYESİ / LEVER

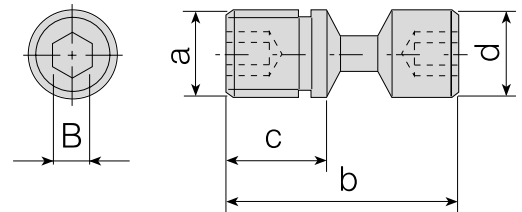

LEVYE VİDALARI / LEVER SCREWS

Takım Kodu Ordering Code	a (M)	b	c	d	B	Ürün Detayı Product Detail	
ALV-01-M6X14	M6x1.0	14	10	5.85	2.5	P-SİSTEM için / For P-SYSTEM	S20R PCLNR/L 09, S20R PDUNR/L 11, S20R PDQNR/L 11, S20R PWLNR/L 06, S20R PTUNR/L 16
ALV-02-M6X17	M6x1.0	17	10	5.85	2.5	P-SİSTEM için / For P-SYSTEM	CNMG 09, DNMG 11, SNMG 09, TNMG 16, WNMG 06
ALV-03-M8X19	M8X1.0	19.8	11	7.9	3	P-SİSTEM için / For P-SYSTEM	CNMG 12, SNMG 12, TNMG 22, WNMG 08, DNMG 15
ALV-04-M8X22	M8X1.0	21.5	13	7.75	3	P-SİSTEM için / For P-SYSTEM	CNMG 16, SNMG 15
ALV-05-M10X27	M10X1.0	27.5	15	9.9	4	P-SİSTEM için / For P-SYSTEM	CNMG 19, SNMG 19
ALV-06-M12X36	M12X1.0	36	20	12	5	P-SİSTEM için / For P-SYSTEM	CNMG 25, SNMG 25
ALV-07-M6X13	M6X0.1	12.6	6.5	5.9	2.5	P-SİSTEM için / For P-SYSTEM	S16P PCLNR/L 09, S16P PCTUR/L 16
ALV-08-M8X16	M8X1.0	16	10	7.9	3	P-SİSTEM için / For P-SYSTEM	S25S PCLNR/L 12, S25S PDUNR/L 15, S25S PSKNR/L 12

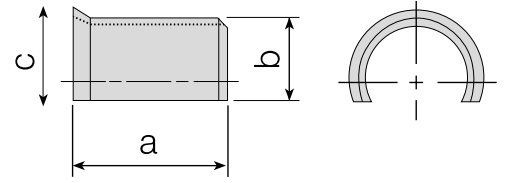

ALTLIK YAYLARI / SHIM SPRINGS

Takım Kodu Ordering Code	ALTLIK YAYLARI / SHIM SPRINGS				
	a	b	c	Ürün Detayı Product Detail	
AAY-01	5.6	4.9	6	P-SİSTEM için / For P-SYSTEM CNMG 09 ,DNMG 11, SNMG 09, TNMG 16, WNMG 06	
AAY-02	6	6.9	7.9	P-SİSTEM için / For P-SYSTEM CNMG 12, SNMG 12, TNMG 22, WNMG 08, DNMG 15	
AAY-03	8.9	8	9.5	P-SİSTEM için / For P-SYSTEM CNMG 16, SNMG 15	
AAY-04	11	9.8	10.7	P-SİSTEM için / For P-SYSTEM CNMG 19, SNMG 19	
AAY-05	12	13	15	P-SİSTEM için / For P-SYSTEM CNMG 25, SNMG 25	

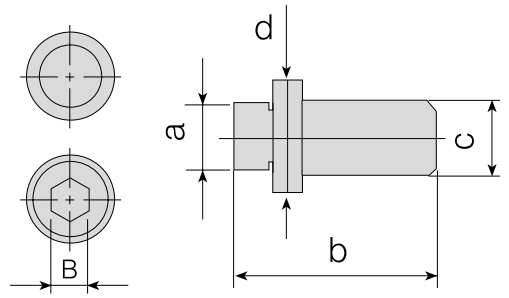

PİMLER / PINS

Takım Kodu Ordering Code	PİMLER / PINS					
	a	b	c	d	B	Ürün Detayı Product Detail
APM-01	3.55	18	5	6	-	M-SİSTEM için / For M- SYSTEM DELİK İÇİ / INTERNAL Ø32-Ø40 TNMG 16 - DIŞ ÇAP / EXTERNAL TNMG 16
APM-02	5	18	6	7.3	-	M-SİSTEM için / For M- SYSTEM TNMG 22, WNMG 08
APM-03	3.5	12	5	6.5	-	M-SİSTEM için / For M- SYSTEM S20R MTFNR/L 16, S20R MT-NR/L 16, S20R MTUNR/L 16, S20R MTQNR/L 16, S20R MDUNR/L 11
APM-04	5	15	6	7.3	-	M-SİSTEM için / For M- SYSTEM S32T MCLNR/L 12, DNMG 15, S25S MWLNR/L 08
APM-05	5	11.5	6.5	6.5	3	M-SİSTEM için / For M- SYSTEM MSYNR 11.5CS 12 KARTUŞ için / for MSYNR 11.5CS 12 CARTRIDGE
APM-06	3	15.7	-	-	-	C-SİSTEM için / For C- SYSTEM 154.91
APM-07	3.5	11.5	6.5	6.5	3	M-SİSTEM için / For M- SYSTEM S20R ET-NR 16
APM-08	3.5	12	5	5.4	-	M-SİSTEM için / For M- SYSTEM S25S MWLNR/L 06, Diş Çap / External MWLNR 06
APM-09	3.5	10	5	5.4	-	M-SİSTEM için / For M- SYSTEM S16P MWLNR/L 06
APM-10	3.5	11	5	5.4	-	M-SİSTEM için / For M- SYSTEM S20R MWLNR/L 06
APM-11	3.5	11	5	6.5	-	M-SİSTEM için / For M- SYSTEM S20R MTQNR/L 16
APM-12	5	12	6	7.3	-	M-SİSTEM için / For M- SYSTEM S20R MCLNR/L 12, S25S MCLNR/L 12-Z
APM-13	5	14	6	7.3	-	M-SİSTEM için / For M- SYSTEM S25S MCLNR/L 12
APM-14	3.55	15	5	6	-	M-SİSTEM için / For M- SYSTEM S25S MTFNR/L 16, S25S MT-NR/L 16, S25S MTUNR/L 16, S25S MTQNR/L 16
APM-15	4.40	16	6.40	6.40	3	M-SİSTEM için / For M- SYSTEM MSYNR 16CS 12 KARTUŞ için / for MSYNR 16CS 12 CARTRIDGE

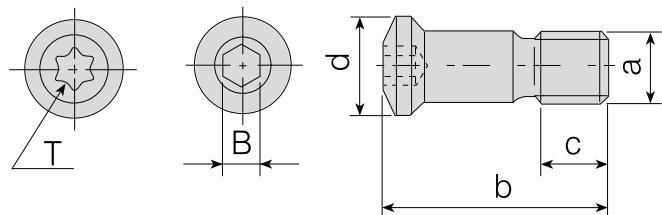

KÜRESEL FİNİŞ VİDALARI / BALL NOSE SCREWS

Takım Kodu Ordering Code	a (M)	b	c	d	B(T)	Ürün Detayı Product Detail	
1208-M3x7	M3x0.5	6.9	2.7	4.1	8	KÜRESEL FREZE VİDASI / BALL NOSE SCREW	P3208
1215-M4X0.5X9	M4X0.5	8.6	3.2	5.75	15	KÜRESEL FREZE VİDASI / BALL NOSE SCREW	P3210-ROHX 12
1220-M5X0.5X9	M5X0.5	9.6	3.4	6.8	20	KÜRESEL FREZE VİDASI / BALL NOSE SCREW	P3212
1220-M5X0.5X12	M5X0.5	12.9	4.4	7.4	20	KÜRESEL FREZE VİDASI / BALL NOSE SCREW	P3216-ROHX 16
1220-M5X0.5X15	M5X0.5	16.4	6	7.8	20	KÜRESEL FREZE VİDASI / BALL NOSE SCREW	P3220-ROHX 20
1220-M6X0.75X20	M6X0.75	20	6	9.4	20	KÜRESEL FREZE VİDASI / BALL NOSE SCREW	P3225
1204-M8X0.75X26	M8X0.75	26	7.5	12	4	KÜRESEL FREZE VİDASI / BALL NOSE SCREW	P3232
1210-M3.5X9.6	M3.5X0.6	9.6	4	4.7	10	KÜRESEL FREZE VİDASI / BALL NOSE SCREW	BNM 12
1215-M4X13.5	M4X0.7	13.5	5	5.8	15	KÜRESEL FREZE VİDASI / BALL NOSE SCREW	BNM 16

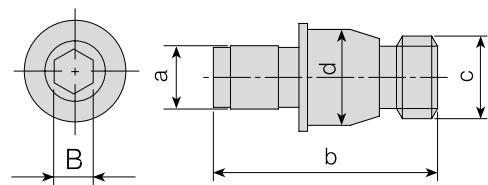

EKSANTRİK VİDA / ECCENTRIC SCREW

Takım Kodu Ordering Code	a	b	c	d	B	Ürün Detayı Product Detail	
AEV-01-M6x16	4.85	16	M6x1.0	6.5	2.5	EKSANTRİK VİDA / ECCENTRIC SCREW	PSDNN KARTUŞ için / for PSDNN CARTRIDGE

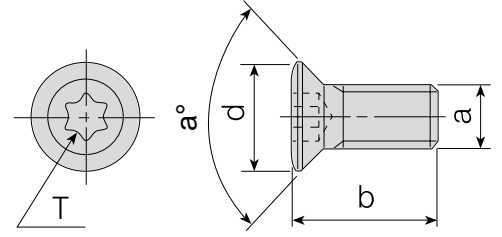

TORK VİDALARI / TORX SCREWS

Takım Kodu Ordering Code	a (M)	b	T	d	a°	Ürün Detayı Product Detail	
						S-SİSTEM için / For S-SYSTEM	TORK VİDA / TORX SCREW
4006-M1.6X3.2	M1.6X0.35	3.2	6	2.50	60	S-SİSTEM için / For S-SYSTEM	TORK VİDA / TORX SCREW
3006-M1.8X4	M1.8X0.35	4	6	2.45	60	S-SİSTEM için / For S-SYSTEM	TORK VİDA / TORX SCREW
3006-M2X4	M2X0.4	4.3	6	2.7	60	S-SİSTEM için / For S-SYSTEM	TORK VİDA / TORX SCREW
4006-M2X5	M2X0.4	5	6	3	55	S-SİSTEM için / For S-SYSTEM	TORK VİDA / TORX SCREW
3007-M2.2X5	M2.2X0.45	5.2	7	3.15	60	S-SİSTEM için / For S-SYSTEM	TORK VİDA / TORX SCREW
4006-M2.2X5	M2.2X0.45	5	6	2.8	55	S-SİSTEM için / For S-SYSTEM	TORK VİDA / TORX SCREW
1008-M2.5X5	M2.5X0.45	5.5	8	3.5	45	S-SİSTEM için / For S-SYSTEM	TORK VİDA / TORX SCREW
1008-M2.5X7	M2.5X0.45	7	8	3.6	45	S-SİSTEM için / For S-SYSTEM	TORK VİDA / TORX SCREW
1108-M2.5x6	M2.5X0.45	6	8	3.9	R	S-SİSTEM için / For S-SYSTEM	TORK VİDA / TORX SCREW
3008-M2.5X5	M2.5X0.45	5	8	3.5	60	S-SİSTEM için / For S-SYSTEM	TORK VİDA / TORX SCREW
3008-M2.5X6	M2.5X0.45	6	8	3.5	60	S-SİSTEM için / For S-SYSTEM	TORK VİDA / TORX SCREW
4008-M2.5X4	M2.5X0.45	4	8	3.5	45	S-SİSTEM için / For S-SYSTEM	TORK VİDA / TORX SCREW
4008-M2.5X4.5	M2.5X0.45	4.5	8	3.5	45	S-SİSTEM için / For S-SYSTEM	TORK VİDA / TORX SCREW
4008-M2.5X6	M2.5X0.45	5.8	8	3.5	45	S-SİSTEM için / For S-SYSTEM	TORK VİDA / TORX SCREW
1008-M3X6	M3X0.5	6	8	4	60	S-SİSTEM için / For S-SYSTEM	TORK VİDA / TORX SCREW
1008-M3X8	M3X0.5	8	8	3.9	60	S-SİSTEM için / For S-SYSTEM	TORK VİDA / TORX SCREW
3008-M3X6	M3X0.5	6	8	4	45	S-SİSTEM için / For S-SYSTEM	TORK VİDA / TORX SCREW
3008-M3X7	M3X0.5	7	8	4	55	S-SİSTEM için / For S-SYSTEM	TORK VİDA / TORX SCREW
3008-M3X8	M3X0.5	8	8	4	45	S-SİSTEM için / For S-SYSTEM	TORK VİDA / TORX SCREW
3108-M3X8	M3X0.5	8	8	3.8	60	S-SİSTEM için / For S-SYSTEM	TORK VİDA / TORX SCREW
4008-M3X8	M3X0.5	8	8	4	60	S-SİSTEM için / For S-SYSTEM	TORK VİDA / TORX SCREW
4010-M3X6	M3X0.5	6	10	4.2	45	S-SİSTEM için / For S-SYSTEM	TORK VİDA / TORX SCREW
4010-M3X8	M3X0.5	8	10	4.2	45	S-SİSTEM için / For S-SYSTEM	TORK VİDA / TORX SCREW
1015-M3.5X9	M3.5X0.6	9	15	5.3	60	S-SİSTEM için / For S-SYSTEM	TORK VİDA / TORX SCREW
1015-M3.5X11	M3.5X0.6	11.1	15	5.3	60	S-SİSTEM için / For S-SYSTEM	TORK VİDA / TORX SCREW
1015-M3.5X14	M3.5X0.6	14	15	5.3	66	S-SİSTEM için / For S-SYSTEM	TORK VİDA / TORX SCREW
1015-M3.5X16	M3.5X0.6	16	15	5.3	55	S-SİSTEM için / For S-SYSTEM	TORK VİDA / TORX SCREW
1315-M3.5X11	M3.5X0.6	10.6	15	7.9	-	S-SİSTEM için / For S-SYSTEM	TORK VİDA / TORX SCREW
1410-M3.5X9	M3.5X0.6	8.2	10	4.75	R	S-SİSTEM için / For S-SYSTEM	TORK VİDA / TORX SCREW
1510-M3.5X7	M3.5X0.6	7.1	10	5.1	55	S-SİSTEM için / For S-SYSTEM	TORK VİDA / TORX SCREW
1510-M3.5X9	M3.5X0.6	9.1	10	5	55	S-SİSTEM için / For S-SYSTEM	TORK VİDA / TORX SCREW
1615-M3.5X10	M3.5X0.6	10	15	5.8	60	S-SİSTEM için / For S-SYSTEM	TORK VİDA / TORX SCREW
1615-M3.5X11	M3.5X0.6	11	15	5.8	60	S-SİSTEM için / For S-SYSTEM	TORK VİDA / TORX SCREW
1615-M3.5X15	M3.5X0.6	15	15	5.8	60	S-SİSTEM için / For S-SYSTEM	TORK VİDA / TORX SCREW
3010-M3.5X7	M3.5X0.6	7	10	5	55	S-SİSTEM için / For S-SYSTEM	TORK VİDA / TORX SCREW
3010-M3.5X9	M3.5X0.6	9	10	5	55	S-SİSTEM için / For S-SYSTEM	TORK VİDA / TORX SCREW
3015-M3.5X9	M3.5X0.6	8.8	15	5.4	60	S-SİSTEM için / For S-SYSTEM	TORK VİDA / TORX SCREW
4015-M3.5X8	M3.5X0.6	7.9	15	5.3	55	S-SİSTEM için / For S-SYSTEM	TORK VİDA / TORX SCREW

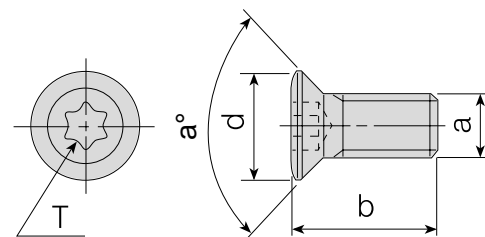

TORK VİDALARI / TORX SCREWS

Takım Kodu Ordering Code	Ürün Detayı Product Detail						TORK VİDA / TORX SCREW
	a (M)	b	T	d	a°	Ürün Detayı Product Detail	
4015-M3.5X9	M3.5X0.6	8.7	15	5.3	60	S-SİSTEM için / For S-SYSTEM	TORK VİDA / TORX SCREW
4015-M3.5X10	M3.5X0.6	9.8	15	5.3	60	S-SİSTEM için / For S-SYSTEM	TORK VİDA / TORX SCREW
4015-M3.5X11	M3.5X0.6	10.7	15	5.3	60	S-SİSTEM için / For S-SYSTEM	TORK VİDA / TORX SCREW
4015-M3.5X12	M3.5X0.6	12	15	5.3	60	S-SİSTEM için / For S-SYSTEM	TORK VİDA / TORX SCREW
4015-M3.5X14	M3.5X0.6	13.7	15	5.3	60	S-SİSTEM için / For S-SYSTEM	TORK VİDA / TORX SCREW
1015-M4X9	M4X0.7	9	15	6.8	R	S-SİSTEM için / For S-SYSTEM	TORK VİDA / TORX SCREW
1515-M4X9	M4X0.7	9	15	5.7	50	S-SİSTEM için / For S-SYSTEM	TORK VİDA / TORX SCREW
1015-M4X11	M4X0.7	10.8	15	6.8	R	S-SİSTEM için / For S-SYSTEM	TORK VİDA / TORX SCREW
1115-M4x10	M4X0.7	10	15	5.9	R	S-SİSTEM için / For S-SYSTEM	TORK VİDA / TORX SCREW
1315-M4X11	M4X0.7	11.1	15	5	45	S-SİSTEM için / For S-SYSTEM	TORK VİDA / TORX SCREW
1415-M4X11	M4X0.7	11	15	5.6	50	S-SİSTEM için / For S-SYSTEM	TORK VİDA / TORX SCREW
1515-M4X11	M4X0.7	11.1	15	5.6	50	S-SİSTEM için / For S-SYSTEM	TORK VİDA / TORX SCREW
1615-M4X11	M4X0.7	11.1	15	6	50	S-SİSTEM için / For S-SYSTEM	TORK VİDA / TORX SCREW
3015-M4X9	M4X0.7	9	15	5.6	50	S-SİSTEM için / For S-SYSTEM	TORK VİDA / TORX SCREW
3015-M4X11	M4X0.7	11	15	5.6	50	S-SİSTEM için / For S-SYSTEM	TORK VİDA / TORX SCREW
4015-M4X9	M4X0.7	9	15	5.6	50	S-SİSTEM için / For S-SYSTEM	TORK VİDA / TORX SCREW
4015-M4X11	M4X0.7	11	15	5.6	50	S-SİSTEM için / For S-SYSTEM	TORK VİDA / TORX SCREW
4015-M4X12	M4X0.7	12	15	5.7	50	S-SİSTEM için / For S-SYSTEM	TORK VİDA / TORX SCREW
4615-M4X11	M4X0.7	11	15	6	50	S-SİSTEM için / For S-SYSTEM	TORK VİDA / TORX SCREW
1015-M4.5X12	M4.5X0.75	12	15	6.6	50	S-SİSTEM için / For S-SYSTEM	TORK VİDA / TORX SCREW
1020-M4.5X16	M4.5X0.75	16	20	6.5	45	S-SİSTEM için / For S-SYSTEM	TORK VİDA / TORX SCREW
1120-M4.5X12	M4.5X0.75	12.1	20	7.9	R	S-SİSTEM için / For S-SYSTEM	TORK VİDA / TORX SCREW
1515-M4.5X11	M4.5X0.75	11	15	6.4	45	S-SİSTEM için / For S-SYSTEM	TORK VİDA / TORX SCREW
4015-M4.5X11	M4.5X0.75	11	15	6.4	45	S-SİSTEM için / For S-SYSTEM	TORK VİDA / TORX SCREW
4020-M4.5X10	M4.5X0.75	10	20	6.6	60	S-SİSTEM için / For S-SYSTEM	TORK VİDA / TORX SCREW
4020-M4.5X12	M4.5X0.75	12	20	6.6	60	S-SİSTEM için / For S-SYSTEM	TORK VİDA / TORX SCREW
1020-M5X11	M5X0.8	11	20	6.6	50	S-SİSTEM için / For S-SYSTEM	TORK VİDA / TORX SCREW
1020-M5X14	M5X0.8	14.1	20	6.8	50	S-SİSTEM için / For S-SYSTEM	TORK VİDA / TORX SCREW
1615-M5x14	M5X0.8	14	15	7.3	50	S-SİSTEM için / For S-SYSTEM	TORK VİDA / TORX SCREW
1620-M5x18	M5X0.8	18	20	8.15	50	S-SİSTEM için / For S-SYSTEM	TORK VİDA / TORX SCREW
1620-M5x22	M5X0.8	22	20	8.15	50	S-SİSTEM için / For S-SYSTEM	TORK VİDA / TORX SCREW
4420-M5X14	M5X0.8	14	20	6.60	60	S-SİSTEM için / For S-SYSTEM	TORK VİDA / TORX SCREW
1020-M6X16	M6X1.0	16	20	8.5	50	S-SİSTEM için / For S-SYSTEM	TORK VİDA / TORX SCREW
1420-M6X16	M6X1.0	16	20	7.6	50	S-SİSTEM için / For S-SYSTEM	TORK VİDA / TORX SCREW
1520-M6X16	M6X1.0	16	20	8.2	50	S-SİSTEM için / For S-SYSTEM	TORK VİDA / TORX SCREW
1710-U5-40X12.2	UNC 5-40	12.2	10	5.6	60	S-SİSTEM için / For S-SYSTEM	TORK VİDA / TORX SCREW
1720-U8-32X15	UNC 8-32	15	20	7.5	60	S-SİSTEM için / For S-SYSTEM	TORK VİDA / TORX SCREW
1707-U4-48X8.2	UNF 4-48	8.2	7	3.27	60	S-SİSTEM için / For S-SYSTEM	TORK VİDA / TORX SCREW

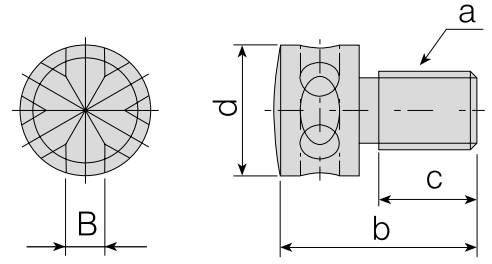

EKSENEL AYAR VİDALARI / AXIAL ADJUSTING SCREWS

Takım Kodu Ordering Code	EKSENEL AYAR VİDALARI / AXIAL ADJUSTING SCREWS					Ürün Detayı Product Detail
	a (M)	b	c	d	B	
2600-M4x9.5	M4x0.5	5.5	4	4	1.5	KARTUŞ için / for CARTRIDGE
2600-M5x13	M5x0.5	12.8	7	8.7	2.5	KARTUŞ için / for CARTRIDGE
2600-M6x18	M6x1.0	18.2	9	10	3.5	KARTUŞ için / for CARTRIDGE

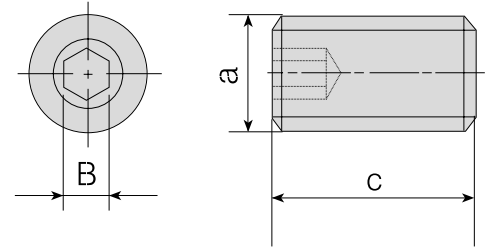

RADYAL AYAR VİDALARI / RADIAL ADJUSTING SCREWS

Takım Kodu Ordering Code	RADYAL AYAR VİDALARI / RADIAL ADJUSTING SCREWS			Ürün Detayı Product Detail
	a (M)	c	B	
2715-M3x4	M3x0.5	4	1.5	KABA BARA için / for ROUGH BORING HEADS
2715-M3x5	M3x0.5	5	1.5	KABA BARA için / for ROUGH BORING HEADS
2715-M3X8	M3x0.5	8	1.5	KABA BARA için / for ROUGH BORING HEADS
2702-M4X10	M4x0.7	10	2	KARTUŞ için / for CARTRIDGE
2702-M4X12	M4x0.7	12	2	KABA BARA için / for ROUGH BORING HEADS
2725-M5X10	M5x0.8	10	2.5	KARTUŞ için / for CARTRIDGE
2725-M5X12	M5x0.8	12	2.5	KABA BARA için / for ROUGH BORING HEADS
2725-M5X14	M5x0.8	14	2.5	KABA BARA için / for ROUGH BORING HEADS
2703-M6X16	M6x1	16	3	KABA BARA için / for ROUGH BORING HEADS
2704-M8X25	M8x1.25	25.9	4	KABA BARA için / for ROUGH BORING HEADS

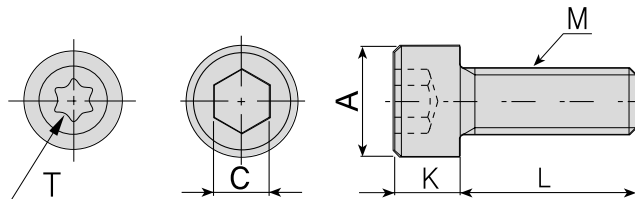

İNBUS CİVATALAR / INBUS SCREWS

Takım Kodu Ordering Code	M	A	C	K	L	Ürün Detayı Product Detail	
2503-M4x10	M4x0.7	6.85	3	4	10	KANAL KATERİ için / For GROOVING TOOLS	KANAL KATER VİDASI / SOME GROOVING TOOLS SCREW
2525-M3X14	M3X0.5	5.4	2.5	2.9	14	BARA KARTUŞU için / for BORING HEADS CARTRIDGE	BARA KARTUŞU için SIKMA VİDASI / for BORING HEADS CARTRIDGE SCREW
2503-M4X20	M4x0.7	7	3	3.9	20	BARA KARTUŞU için / for BORING HEADS CARTRIDGE	BARA KARTUŞU için SIKMA VİDASI / for BORING HEADS CARTRIDGE SCREW
2503-M4X12	M4x0.7	6.85	3	4	12	KANAL KATERİ için / For GROOVING TOOLS	KANAL KATER VİDASI / SOME GROOVING TOOLS SCREW
2503-M4X15	M4x0.7	6.85	3	4	15	BARA KARTUŞU için / for BORING HEADS CARTRIDGE	BARA KARTUŞU için SIKMA VİDASI / for BORING HEADS CARTRIDGE SCREW
2504-M5X16	M5X0.8	8.5	4	5	16	KANAL KATERİ için / For GROOVING TOOLS	KANAL KATER VİDASI / SOME GROOVING TOOLS SCREW
2504-M5X12	M5X0.8	8.5	4	5	12	KANAL KATERİ için / For GROOVING TOOLS	KANAL KATER VİDASI / SOME GROOVING TOOLS SCREW
2504-M5X25	M5X0.8	8.5	4	5	25	BARA KARTUŞU için / for BORING HEADS CARTRIDGE	BARA KARTUŞU için SIKMA VİDASI / for BORING HEADS CARTRIDGE SCREW
2505-M6X16	M6X1	9.9	5	6	16	KANAL KATERİ için / For GROOVING TOOLS	KANAL KATER VİDASI / SOME GROOVING TOOLS SCREW
2505-M6X20	M6X1	9.9	5	6	20	KANAL KATERİ için / For GROOVING TOOLS	KANAL KATER VİDASI / SOME GROOVING TOOLS SCREW
2505-M6X25	M6X1	9.9	5	6	25	BLOK için / For BLOCK	BLOK BASKI PABUÇ VİDASI / for BLOCK CLAMP SCREW
2505-M6X30	M6X1	9.9	5	6	30	BARA KARTUŞU için / for BORING HEADS CARTRIDGE	BARA KARTUŞU için SIKMA VİDASI / for BORING HEADS CARTRIDGE SCREW
2405-M8X30	M8X1.25	11.6	5	8.1	30	FREZELEME TAKIMLARI için / for MILLING TOOLS	A16 MONTAJ VİDASI (KAFASI KÜÇÜK) / MOUNTING SCREW (SMALL HEAD)
2506-M8X20	M8X1.25	13	6	7.9	20	KARTUŞ için / for CARTRIDGE	KARTUŞ MONTAJ VİDASI / CARTRIDGE MOUNTING SCREW
2506-M8X30	M8X1.25	13	6	8.1	30	FREZELEME TAKIMLARI için / for MILLING TOOLS	A16 MONTAJ VİDASI / MOUNTING SCREW
2506-M8X35	M8X1.25	13	6	8.1	35	BARA KARTUŞU için / for BORING HEADS CARTRIDGE	BARA KARTUŞU için SIKMA VİDASI / for BORING HEADS CARTRIDGE SCREW
2406-M8X30	M8X1.25	15.75	6	6	30	FREZELEME TAKIMLARI için / for MILLING TOOLS	A16 MONTAJ VİDASI / MOUNTING SCREW
2408-M8X30	M8X1.25	13.9	8	10	30	FREZELEME TAKIMLARI için / for MILLING TOOLS	A16 MONTAJ VİDASI / MOUNTING SCREW
2407-M10X30	M10X1.5	16	7	6	30	FREZELEME TAKIMLARI için / for MILLING TOOLS	A22 MONTAJ VİDASI / MOUNTING SCREW
2408-M10X30	M10X1.5	13.90	8	10	30	FREZELEME TAKIMLARI için / for MILLING TOOLS	A22 MONTAJ VİDASI / MOUNTING SCREW
2508-M10X30	M10X1.5	16	8	10	30	FREZELEME TAKIMLARI için / for MILLING TOOLS	A22 MONTAJ VİDASI / MOUNTING SCREW
2508-M10X40	M10X1.5	16	8	10	40	BARA KARTUŞU için / for BORING HEADS CARTRIDGE	BARA KARTUŞU için SIKMA VİDASI / for BORING HEADS CARTRIDGE SCREWS
2408-M12X35	M12X1.75	18	8	7	35	FREZELEME TAKIMLARI için / for MILLING TOOLS	A27 MONTAJ VİDASI / MOUNTING SCREW
2510-M12X35	M12X1.75	18	10	12	35	FREZELEME TAKIMLARI için / for MILLING TOOLS	A27 MONTAJ VİDASI / MOUNTING SCREW
2514-M16X35	M16X2.0	23.7	14	16	35	FREZELEME TAKIMLARI için / for MILLING TOOLS	A32 MONTAJ VİDASI / MOUNTING SCREW
AAV-11-U5-40x4.5	UNC 5-40	5.4	T10	2.8	4.5	DİŞ AÇMA TAKIMLARI için / for THREADING TOOLS	16 ER/L, 16 IR/L ALTLIK VİDASI / SHIM SCREW
AAV-12-U8-32x5.5	UNC 8-32	6.7	T20	3.8	5.5	DİŞ AÇMA TAKIMLARI için / for THREADING TOOLS	22 ER/L, 22 IR/L ALTLIK VİDASI / SHIM SCREW
AAV-15-M5x5.7	M5X0.8	8.5	T20	3.15	5.7	DİŞ AÇMA TAKIMLARI için / for THREADING TOOLS	27 ER/L, 27 IR/L ALTLIK VİDASI / SHIM SCREW

SEKMAN / RING

Ürün Resmi Product Picture	Ürün Kodu Product Code	Ürün Detayı Product Detail
		ACS-01

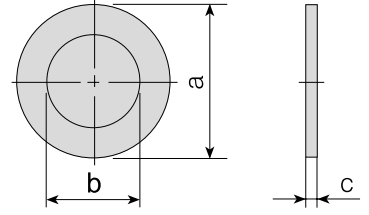

BASKI PULU / STAMP

Takım Kodu Ordering Code	BASKI PULU / STAMP			Ürün Detayı Product Detail
	a	b	c	
ABPL-01	11	6.5	0.5	PUL / STAMP BASKI PULU
ABPL-02	12.75	7.1	0.45	PUL / STAMP BASKI PULU

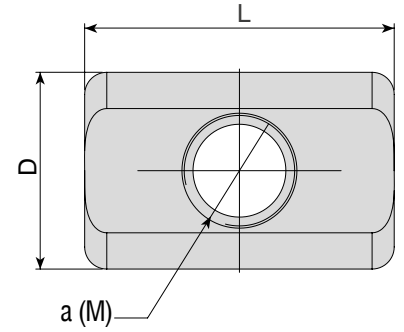

BARA PABUÇLARI / BORING HEADS CARTRIDGE

Takım Kodu Ordering Code	BARA PABUÇLARI / BORING HEADS CARTRIDGE			Ürün Detayı Product Detail
	a (M)	D	L	
ABKS-D16	M3x0.5	4.9	6	KABA BARA için / for ROUGH BORING HEADS ABHR-D16x42-W16-L90
ABKS-D20	M4x0.7	5.9	9	KABA BARA için / for ROUGH BORING HEADS ABHR-D20x50-W20-L100
ABKS-D25	M4x0.7	5.9	12	KABA BARA için / for ROUGH BORING HEADS ABHR-D25x60-W20-L110
ABKS-D32	M5x0.8	8.9	14	KABA BARA için / for ROUGH BORING HEADS ABHR-D32x64-W25-L120
ABKS-D40	M6x1	10.9	18	KABA BARA için / for ROUGH BORING HEADS ABHR-D40x80-W32-L140
ABKS-D50	M8x1.25	13.9	28	KABA BARA için / for ROUGH BORING HEADS ABHR-D50x100-W32-L160
ABKS-D63	M10x1.5	15.9	35	KABA BARA için / for ROUGH BORING HEADS ABHR-D63x80-W32-L140, ABHR-D63x130-W40-L200
ABKS-D80	M12x1.75	17.9	45	KABA BARA için / for ROUGH BORING HEADS ABHR-D80x140-W40-L210, ABHR-D80x140-W40-L210 -B



Ürün Resmi Product Picture	KESME ve KANAL LAMA AÇMA BLOK PABUÇLARI / BLOCKS FOR PARTING AND DEEP GROOVING BLADES CLAMPS		
	Ürün Kodu Product Code	Ürün Detayı Product Detail	
	ABK-01	LAMA BLOĞU için For BLADE BLOCK	ALBU-20-26 BASKI PABUCU / CLAMP
	ABK-02	LAMA BLOĞU için For BLADE BLOCK	ALBU-25-26 BASKI PABUCU / CLAMP
	ABK-03	LAMA BLOĞU için For BLADE BLOCK	ALBU-20-32 BASKI PABUCU / CLAMP
	ABK-04	LAMA BLOĞU için For BLADE BLOCK	ALBU-25-32, ALBU-32-32 BASKI PABUCU / CLAMP

Ürün Resmi Product Picture	LAMA ANAHTARI / BLADE KEY	
	Ürün Kodu Product Code	Ürün Detayı Product Detail
	ALA-01	AKL LAMA ANAHTARI / for BLADE KEY

Ürün Resmi Product Picture	ALYAN ANAHTARLARI / ALLEN KEYS	
	Ürün Kodu Product Code	Ürün Detayı Product Detail
	AAL-01-2	2 mm ALYAN ANAHTARI / ALLEN KEYS
	AAL-02-2.5	2.5 mm ALYAN ANAHTARI / ALLEN KEYS
	AAL-03-3	3 mm ALYAN ANAHTARI / ALLEN KEYS
	AAL-05-4	4 mm ALYAN ANAHTARI / ALLEN KEYS
	AAL-07-5	5 mm ALYAN ANAHTARI / ALLEN KEYS
	AAL-08-6	6 mm ALYAN ANAHTARI / ALLEN KEYS
	AAL-09-1.5	1.5 mm ALYAN ANAHTARI / ALLEN KEYS
	AAL-11-8	8 mm ALYAN ANAHTARI / ALLEN KEYS
AAL-12-10	10 mm ALYAN ANAHTARI / ALLEN KEYS	

Ürün Resmi Product Picture	TORK ANAHTARLARI / TORX KEYS	
	Ürün Kodu Product Code	Ürün Detayı Product Detail
	80-T06	T06 TORK ANAHTARI / TORX KEY
	80-T07	T07 TORK ANAHTARI / TORX KEY
	80-T08	T08 TORK ANAHTARI / TORX KEY
	80-T10	T10 TORK ANAHTARI / TORX KEY
	80-T15	T15 TORK ANAHTARI / TORX KEY
	80-T20	T20 TORK ANAHTARI / TORX KEY
	81-T15	T15 T-TİP TORK ANAHTARI / T-TYPE TORX KEY
	81-T20	T20 T-TİP TORK ANAHTARI / T-TYPE TORX KEY

KOD / CODE	AÇIKLAMA / DESCRIPTION	S.N. P.N.
1008..	Spare Parts	282
1015..	Spare Parts	282/283
1020..	Spare Parts	283
1108..	Spare Parts	282
1120..	Spare Parts	283
1204..	Spare Parts	281
1208..	Spare Parts	281
1210..	Spare Parts	281
1215..	Spare Parts	281
1220..	Spare Parts	281
1315..	Spare Parts	282/283
1410..	Spare Parts	282
1415..	Spare Parts	283
1420..	Spare Parts	283
1510..	Spare Parts	282
1515..	Spare Parts	283
1520..	Spare Parts	283
1615..	Spare Parts	282/283
1620..	Spare Parts	283
1700..	Spare Parts	283
1710..	Spare Parts	283
1720..	Spare Parts	283
1904..	Spare Parts	279
2004..	Spare Parts	279
2405..	Spare Parts	285
2406..	Spare Parts	285
2407..	Spare Parts	285
2408..	Spare Parts	285
2503..	Spare Parts	285
2504..	Spare Parts	285
2505..	Spare Parts	285
2506..	Spare Parts	285
2508..	Spare Parts	285
2510..	Spare Parts	285
2514..	Spare Parts	285
2525..	Spare Parts	285
2600..	Spare Parts	284
2702..	Spare Parts	284
2703..	Spare Parts	284
2704..	Spare Parts	284
2715..	Spare Parts	284
2725..	Spare Parts	284
3006..	Spare Parts	282
3007..	Spare Parts	282
3008..	Spare Parts	282
3010..	Spare Parts	282
3015..	Spare Parts	282/283
3108..	Spare Parts	282
4006..	Spare Parts	282
4008..	Spare Parts	280
4010..	Spare Parts	282
4015..	Spare Parts	282/283
4020..	Spare Parts	283
4420..	Spare Parts	283
4615..	Spare Parts	283
80..	Spare Parts	287
81..	Spare Parts	287
A/SCLCR/L ..	Boring Bars	90
A/SDUCR/L ..	Boring Bars	91
AACN..	Spare Parts	274
AADN..	Spare Parts	274
AAKT-IG-R/L ..	Face External Grooving Tool Holders	129
AAKT-KG-R/L ..	Face External Grooving Tool Holders	126
AAKT-K-R/L ..	Face External Grooving Tool Holders	127
AAKT-ZCC2-R/L ..	Face External Grooving Tool Holders	128
AAL..	Spare Parts	287
AARC..	Spare Parts	274
AASD..	Spare Parts	274
AASE..	Spare Parts	274
AASN..	Spare Parts	274
AATN..	Spare Parts	274
AAV..	Spare Parts	276/277/285

KOD / CODE	AÇIKLAMA / DESCRIPTION	S.N. P.N.
AAVN..	Spare Parts	274
AAWN..	Spare Parts	274
AAV..	Spare Parts	280
ABHR ..	Adjustable Rough Boring Heads	175
ABHRS ..	Adjustable Rough Boring Heads Body	176
ABK..	Spare Parts	287
ABKS..	Spare Parts	286
ABPL..	Spare Parts	286
ACBM ..	Countersink Open Milling Tools	183
ACK..	Spare Parts	275
ACM ..	Chamfering End Mills	181
ACM45-SP..	Chamfering End Mills	182
ACS..	Spare Parts	285
ADCR	Drill Chamfering Ring Tools	166
ADKT-123-R/L ..	External Grooving Tool Holders	118
ADKT-151.22-R/L ..	External Grooving Tool Holders	119
ADKT-151.23-R/L ..	External Grooving Tool Holders	119
ADKT-154.91-R/L ..	External Grooving Tool Holders	120
ADKT-ARN-R/L ..	External Grooving Tool Holders	120
ADKT-CD-R/L ..	External Grooving Tool Holders	124
ADKT-GP-R/L ..	External Grooving Tool Holders	123
ADKT-H22-R/L ..	External Grooving Tool Holders	122
ADKT-HK-R/L ..	External Grooving Tool Holders	114
ADKT-H-R/L ..	External Grooving Tool Holders	114
ADKT-HS223-R/L ..	External Grooving Tool Holders	114
ADKT-IDC-R/L ..	External Grooving Tool Holders	117
ADKT-IGI-R/L ..	External Grooving Tool Holders	117
ADKT-IG-R/L ..	External Grooving Tool Holders	117
ADKT-IGTN-R/L ..	External Grooving Tool Holders	117
ADKT-I-R/L ..	External Grooving Tool Holders	117
ADKT-I-R/L ..S	External Grooving (Swiss Type) Tool Holders	126
ADKT-ITG-R/L ..	External Grooving Tool Holders	116
ADKT-KG-R/L ..	External Grooving Tool Holders	113
ADKT-KG-R/L ..S	External Grooving (Swiss Type) Tool Holders	125
ADKT-KM-R/L ..	External Grooving Tool Holders	118
ADKT-K-R/L ..	External Grooving Tool Holders	112
ADKT-LGC-R/L ..	External Grooving Tool Holders	122
ADKT-SGC-R/L ..	External Grooving Tool Holders	113
ADKT-SWC-R/L ..	External Grooving Tool Holders	121
ADKT-TD-R/L ..	External Grooving Tool Holders	121
ADKT-TD-R/L ..S	External Grooving (Swiss Type) Tool Holders	124
ADKT-WGX24-R/L ..	External Grooving Tool Holders	123
ADKT-ZCC1-R/L ..	External Grooving Tool Holders	116
ADKT-ZCC2-R/L ..	External Grooving Tool Holders	115
ADKT-ZCC2-R/L ..S	External Grooving (Swiss Type) Tool Holders	125
AEKR/L ..	Economic Cutting Tools	172
AEM90-3P..	End Mills	202
AEM90-4N..	End Mills	203
AEM90-AD..	End Mills	184-185-186
AEM90-AD..	Modular End Mills	211
AEM90-AN..	End Mills	186-187
AEM90-AO..	End Mills	192
AEM90-AO..	Modular End Mills	210
AEM90-AP..	End Mills	187/188/189/190/191
AEM90-AP..	Modular End Mills	212
AEM90-AX..	End Mills	192/193
AEM90-AX..	Modular End Mills	211
AEM90-AZ..	End Mills	194
AEM90-BD..	End Mills	195
AEM90-DC..	Modular End Mills	213
AEM90-ED..	End Mills	196
AEM90-LN..	End Mills	196/197
AEM90-R390..	End Mills	197
AEM90-R390..	Modular End Mills	214
AEM90-RT..	End Mills	198
AEM90-RT..	Modular End Mills	213
AEM90-SE..	End Mills	199
AEM90-SO..	End Mills	199
AEM90-SPGT..	End Mills	200
AEM90-XC..	End Mills	200
AEM90-XD..	End Mills	201
AEM90-XO..	End Mills	201

KOD / CODE	AÇIKLAMA / DESCRIPTION	S.N. P.N.
AEM90-ZC..	End Mills	202
AEM90-ZP..	End Mills	203
AEM95(C)-XD..	Modular End Mills	214
AEMR(C)-RD..	Face and Copy End Mills	205
AEMR-QP..	Face and Copy Mills	204
AEMR-QP..	Modular End Mills	217
AEMR-RC..	Modular End Mills	215
AEMR-RD..	Modular End Mills	216
AEMR-RP..	Face and Copy Mills	204
AEMR-RP..	Modular End Mills	215
AEMR-RP..	Modular End Mills	217
AEMR-RY..	Face and Copy End Mills	206
AET	Eccentric Adaptör For U-Drill	168
AEV..	Spare Parts	281
AFM42C-XD..	Face Milling	228
AFM43(C)-OD..	Face Milling	228/229
AFM43C-OF..	Face Milling	258
AFM43-OF..	Face Milling	229
AFM43-ON..	Face Milling	230
AFM45(L)-HN..	Face Milling	230
AFM45(L)-SE..	Face Milling	231
AFM45(S)-SE	Face Milling	231-232
AFM45C(L)-HN..	Face Milling	257
AFM45C(L)-SN..	Face Milling	232/233/234
AFM45-ON..	Face Milling	234
AFM45-SA..	Face Milling	233
AFM67-PN..	Face Milling	235
AFM75-AP..	Face Milling	235
AFM75C-SP..	Face Milling	257
AFM75-XO..	Face Milling	236
AFM88C-SN..	Face Milling	236/237
AFM90(L)-LN..	Face Milling	243/244/245
AFM90(S)-SD..	Face Milling	247/248
AFM90-3P..	Face Milling	252
AFM90-490..	Face Milling	246
AFM90-AD..	Face Milling	237/238
AFM90-AN..	Face Milling	239/240
AFM90-AO..	Face Milling	240
AFM90-AP..	Face Milling	241
AFM90-AX..	Face Milling	242
AFM90-BD..	Face Milling	242
AFM90C-TP..	Face Milling	258
AFM90-R290..	Face Milling	245
AFM90-R390..	Face Milling	246
AFM90-RT..	Face Milling	247
AFM90-SE..	Face Milling	248/249
AFM90-SP..	Face Milling	249
AFM90-TN..	Face Milling	250
AFM90-TP..	Face Milling	250
AFM90-WN..	Face Milling	251
AFM90-XN..	Face Milling	251
AFM90-XO..	Face Milling	252
AFMR(C)-RD..	Face Milling	254
AFMR-QP..	Face Milling	256
AFMR-RC..	Face Milling	253
AFMR-RP..	Face Milling	255
AFMR-RY..	Face Milling	256
AHFM(C)-WD..	High Feed End Mills	208/209
AHFM(C)-WD..	Modular High Feed End Mills	220
AHFM-BL..	High Feed End Mills	206
AHFM-BL..	High Feed Milling Tools	260
AHFM-BL..	Modular High Feed End Mills	218
AHFM-C-JD..	High Feed Milling Tools	261
AHFM-C-SD..	High Feed End Mills	208
AHFM-C-SD..	High Feed Milling Tools	262
AHFM-C-SD..	Modular High Feed End Mills	219
AHFM-C-WD..	High Feed Milling Tools	263/264
AHFM-ED..	Modular High Feed End Mills	218
AHFM-EO..	High Feed End Mills	207
AHFM-EP..	High Feed End Mills	207
AHFM-EP..	High Feed Milling Tools	261
AHFM-EP..	Modular High Feed End Mills	219

KOD / CODE	AÇIKLAMA / DESCRIPTION	S.N. P.N.	KOD / CODE	AÇIKLAMA / DESCRIPTION	S.N. P.N.	KOD / CODE	AÇIKLAMA / DESCRIPTION	S.N. P.N.
AHFM-WN..	High Feed End Mills	209	CDJNR/L ..	External Tool Holders	34	SDUCR/L ..	Internal Tool Holders	80
AHFM-WN..	High Feed Milling Tools	263	CDNNN ..	External Tool Holders	34	SDXCR/L ..	Internal Tool Holders	81
AHFM-WN..	Modular High Feed End Mills	221	CKJNR/L ..	External Tool Holders	33	SER/L ..	External Threading Tool Holders	104
AHFM-WO..	High Feed End Mills	210	CKUNR/L ..	Internal Tool Holders	64	SIR/L ..	Internal Threading Tool Holders	105
AHM ..	Helix Chamfer Milling Tools	182	CRDCN ..	External Tool Holders	35	SRDCN ..	External Tool Holders	42
AHM90-AP..	Helix End Mills	227	CSDNN ..	External Tool Holders	35	SRDCR/L ..	External Tool Holders	43
AIKT ..	Mini Grooving Tool	140	CSKNR/L ..	External Tool Holders	36	SRGCR/L ..	External Tool Holders	43
AIKT-123-R/L ..	Internal Grooving Tool Holders	135	CSRNR/L ..	External Tool Holders	36	SRGCR/L ..	Internal Tool Holders	81
AIKT-154.91-R/L ..	Internal Grooving Tool Holders	135	CSNR/L ..	External Tool Holders	37	SRHCR/L ..	External Tool Holders	44
AIKT-GP-R/L ..	Internal Grooving Tool Holders	139	CTJNR/L ..	External Tool Holders	37	SRXCR/L ..	External Tool Holders	44
AIKT-HK-R/L ..	Internal Grooving Tool Holders	134	E/SCLCR/L ..	Boring Bars	90	SSDCN ..	External Tool Holders	45
AIKT-H-R/L ..	Internal Grooving Tool Holders	133	E/SDUCR/L ..	Boring Bars	91	SSKCR/L ..	Cartridge	97
AIKT-HS223-R/L ..	Internal Grooving Tool Holders	134	MCLNR/L ..	Internal Tool Holders	66	SSSCR/L ..	External Tool Holders	45
AIKT-IGE-R/L ..	Internal Grooving Tool Holders	136	MDUNR/L ..	Internal Tool Holders	66	SSSCR/L ..	Internal Tool Holders	82
AIKT-IGI-R/L ..	Internal Grooving Tool Holders	137	MTENN ..	External Tool Holders	21	STCCN ..	External Tool Holders	47
AIKT-IG-R/L ..	Internal Grooving Tool Holders	138	MTFNR/L ..	Internal Tool Holders	67	ST-CR/L ..	Internal Tool Holders	82
AIKT-I-R/L ..	Internal Grooving Tool Holders	137	MTJNR/L ..	External Tool Holders	21	STFCR/L	Spare Parts Of Cartridge	100
AIKT-ITG-R/L ..	Internal Grooving Tool Holders	138	MT-NR/L ..	Internal Tool Holders	67	STFCR/L ..	Cartridge	97
AIKT-KG-R/L ..	Internal Grooving Tool Holders	133	MTQNR/L ..	Internal Tool Holders	68	STFCR/L ..	External Tool Holders	46
AIKT-KM-R/L ..	Internal Grooving Tool Holders	134	MTUNR/L ..	Internal Tool Holders	68	STFCR/L ..	Internal Tool Holders	83
AIKT-K-R/L ..	Internal Grooving Tool Holders	132	MWLNLR/L ..	External Tool Holders	22	STGCR/L ..	External Tool Holders	46
AIKT-SGC-R ..	Internal Grooving Tool Holders	139	MWLNLR/L ..	Internal Tool Holders	69	STGCR/L ..S	External Tool Holders Swiss Type	53
AIKT-ZCC2-R/L ..	Internal Grooving Tool Holders	136	MWMNN ..	External Tool Holders	22	STJCR/L ..	External Tool Holders	47
AKCR ..	Adjustable Rough Boring Heads Cartridge	177	PCBNR/L ..	External Tool Holders	24	STSCR/L	Spare Parts Of Cartridge	100
AKL-123 ..	Blades	131	PCLNR/L ..	External Tool Holders	24	STSCR/L ..	Cartridge	98
AKL-I ..	Blades	130	PCLNR/L ..	Internal Tool Holders	71	STTCR/L	Spare Parts Of Cartridge	100
AKS ..	Spare Parts	274	PCMNN ..	External Tool Holders	25	STUCR/L ..	External Tool Holders	48
AKSR ..	Adjustable Rough Boring Heads Cartridge	177	PDJNR/L ..	External Tool Holders	25	STUCR/L ..	Internal Tool Holders	83
AKV ..	Spare Parts	276/278/279	PDNNN ..	External Tool Holders	26	STUPR/L ..	Internal Tool Holders	84
AKY ..	Spare Parts	278	PDQNR/L ..	Internal Tool Holders	72	STXCR/L ..	Engine Overhaul Cartridge	95
ALA ..	Spare Parts	287	PDUNR/L ..	Internal Tool Holders	73	SVACR/L ..S	External Tool Holders Swiss Type	54
ALBU ..	Blocks For Blades	131	PDXNR/L ..	Internal Tool Holders	72	SVHBR/L ..	External Tool Holders	48
ALKT-ZCC2-R/L ..	Face External Grooving Tool Holders	130	PSBNR/L ..	External Tool Holders	26	SVHCR/L ..	External Tool Holders	49
ALV ..	Spare Parts	279	PSDNN ..	Cartridge	100	SVJBR/L ..	External Tool Holders	49
AMK ..	Spare Parts	275	PSDNN ..	External Tool Holders	27	SVJBR/L ..	Internal Tool Holders	84
APL ..	Spare Parts	279	PSKNN ..	Cartridge	99	SVJBR/L ..S	External Tool Holders Swiss Type	54
APM ..	Spare Parts	280	PSKNR/L ..	External Tool Holders	27	SVJCR/L ..	External Tool Holders	50
APMR-P32..	Ball Nose End Mills	221	PSKNR/L ..	Internal Tool Holders	73	SVJCR/L ..	Internal Tool Holders	87
APMR-P32..	Ball Nose Modular End Mills	223	PSKNR/L ..	Internal Tool Holders	73	SVJCR/L ..S	External Tool Holders Swiss Type	55
APMR-RO..	Ball Nose End Mills	222	PSSNR/L ..	External Tool Holders	28	SVQBR/L ..	Internal Tool Holders	85
APMR-SWB..	Ball Nose Modular End Mills	223	PTFNR/L ..	Cartridge	99	SVQBR/L ..	Internal Tool Holders	85
APMR-XP..	Ball Nose End Mills	222	PTFNR/L ..	External Tool Holders	28	SVUBR/L ..	Internal Tool Holders	86
APMR-XP..	Ball Nose Modular End Mills	224	PTGNR/L ..	External Tool Holders	29	SVUCR/L ..	Internal Tool Holders	86
ASDM-CC..	Disc Milling	268	PTJNR/L ..	External Tool Holders	29	SVVBN ..	External Tool Holders	50
ASDM-SPGT..	Disc Milling	267	PTTNR/L ..	External Tool Holders	30	SVVCN ..	External Tool Holders	51
ATK ..	Spare Parts	275	PTUNR/L ..	Internal Tool Holders	74	SVXBR/L ..	Internal Tool Holders	87
ATM ..	Thread Milling Tools	225	PWLNR/L ..	External Tool Holders	30	SWLCR ..	Internal Tool Holders	88
ATM60..	Thread Milling Tools	226	PWLNR/L ..	Internal Tool Holders	75	SWUBR ..	Internal Tool Holders	88
ATS ..	Spare Parts	274	S/SCLCR/L ..	Boring Bars	90	TCBNR/L ..	External Tool Holders	11
ATSM90-CC..	T Slot Milling	265	S/SDUCR/L ..	Boring Bars	91	TCKNR/L ..	External Tool Holders	11
ATSM90-SP..	T Slot Milling	266	SCACR/L ..	Engine Overhaul Cartridge	94	TCLNR/L ..	External Tool Holders	12
ATSMR-RD..	T Slot Milling	266	SCACR/L ..	External Tool Holders	39	TCLNR/L ..	Internal Tool Holders	60
ATUM .. xD2 KDR ..	U-Drill	160	SCACR/L ..S	External Tool Holders Swiss Type	51	TCMNN ..	External Tool Holders	12
ATUM .. xD2 SP ..	U-Drill	150/151	SCFCR/L	Spare Parts Of Cartridge	100	TCZNN ..	External Tool Holders	13
ATUM .. xD2 SPGT ..	U-Drill	155	SCFCR/L ..	Cartridge	96	TDHNR/L ..	External Tool Holders	13
ATUM .. xD2 WCM ..	U-Drill	144/145	SCFCR/L ..	Internal Tool Holders	78	TDJNR/L ..	External Tool Holders	14
ATUM .. xD3 KDR ..	U-Drill	161	SCLCR/L ..	Boring Bars With Carbide Shank	89	TDNNN ..	External Tool Holders	14
ATUM .. xD3 SO ..	U-Drill	159	SCLCR/L ..	External Tool Holders	39	TD-NR/L ..	Internal Tool Holders	60
ATUM .. xD3 SP ..	U-Drill	152/153	SCLCR/L ..	Internal Tool Holders	77	TDQNR/L ..	Internal Tool Holders	61
ATUM .. xD3 SPGT ..	U-Drill	156/157	SCLCR/L ..S	External Tool Holders Swiss Type	52	TDUNR/L ..	Internal Tool Holders	61
ATUM .. xD3 WCM ..	U-Drill	146/147	SCMNN ..	Engine Overhaul Cartridge	95	TER/L ..	External Threading Tool Holders	106
ATUM .. xD4 KDR ..	U-Drill	160	SCMNN ..	External Tool Holders	40	TIR/L ..	Internal Threading Tool Holders	107
ATUM .. xD4 SO ..	U-Drill	159	SCSCR/L	Spare Parts Of Cartridge	100	TSDNN ..	External Tool Holders	15
ATUM .. xD4 SP ..	U-Drill	154	SCSCR/L ..	Cartridge	96	TSKNR/L ..	External Tool Holders	15
ATUM .. xD4 SPGT ..	U-Drill	158	SDACR/L ..S	External Tool Holders Swiss Type	52	TSKNR/L ..	Internal Tool Holders	62
ATUM .. xD4 WCM ..	U-Drill	148/149	SD-CR/L ..	Internal Tool Holders	78	TSSNR/L ..	External Tool Holders	16
ATUM xD2 SOMT ..	U-Drill	162	SDHCR/L ..	External Tool Holders	40	TTENN ..	External Tool Holders	16
ATUM xD3 SOMT ..	U-Drill	163	SDJCR/L ..	External Tool Holders	41	TTGNR/L ..	External Tool Holders	17
ATUM xD4 SOMT ..	U-Drill	164	SDJCR/L ..S	External Tool Holders Swiss Type	53	TTJNR/L ..	External Tool Holders	17
ATUM xD5 SOMT ..	U-Drill	165	SDNCR ..	External Tool Holders	41	TT-NR/L ..	Internal Tool Holders	62
AVTT..	Screwed Tool Holders	224	SDPCR/L ..	Internal Tool Holders	79	TTUNR/L ..	Internal Tool Holders	63
CCLNR/L ..	External Tool Holders	33	SDQCR/L ..	Internal Tool Holders	79	TVHNR/L ..	External Tool Holders	18
			SDUCR/L ..	Boring Bars With Carbide Shank	89	TVJNR/L ..	External Tool Holders	18
						TVUNR/L ..	Internal Tool Holders	63
						TVVNN ..	External Tool Holders	19
						TWLNRL ..	External Tool Holders	19
						TWLNRL ..	Internal Tool Holders	64



Bu katalogdaki kodlar, fotoğraflar ve bilgiler izin alınmadan kullanılamaz, hiçbir şekilde kopyalanamaz ve dijital ortamda yayımlanamaz. AKKO; ürünlerinde, kodlarında ve özelliklerinde değişiklik yapma hakkını saklı tutar.

www.akkocom.tr

Дистрибьютер ООО "Ресурс Плюс"
+7 (351) 247-74-40; info@rp-ural.ru



