

DELİK TORNA TAKIMLARI
INTERNAL TURNING TOOLHOLDERS





1 Takım Malzemesi / Type of Boring Bar

"A" Yekpare çelik gövde soğutma suyu kanallı / "A" Solid steel with coolant hole
 "E" Çelik başlıkla sert metal gövde ve soğutma suyu kanallı /
 "E" Carbide bar with fixed steel head and coolant hole
 "C" Karbür Şaft / "C" Carbide shank
 "S" Çelik Şaft / "S" Steel shank

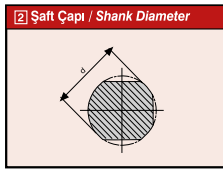

3 Şaft Boyu / Shank Length

A - 32	H - 100	Q - 180	x-special
B - 40	J - 110	R - 200	
C - 50	K - 125	S - 250	
D - 60	L - 140	T - 300	
E - 70	M - 150	U - 350	
F - 80	N - 160	V - 400	
G - 90	P - 170	W - 450	

(mm)

4 Sıkma Tipi / Method of Mounting of Insert

C Deliksiz Üstten Sıkma / Top clamping without hole
 T Üstten Delikle Sıkma / Top and Hole Clamping
 M Üstten ve Delikten Sıkma / Top and Hole Clamping
 P Delikten Laye ile Sıkma / Hole Clamping (Lever Lock)
 S Vida ile Sıkma / Screw on

5 Uç Tipi / Insert Shape

C	D	E
V	R	S
W	K	T

6 Yanaşma Açısı / Tool Holder Shape Bar Geometry

7 Serbest Uç Açısı / Insert Clearance Angle

8 Kesme Yönü / Cutting Direction

9 Kesme Kenar Uzunluğu / Cutting Edge Length

10 Baskı Pabucu / Wedge Clamp



T&C-SİSTEM

T&C SİSTEM DELİK TORNA KATERLERİ
T&C SYSTEM BORING BARS

konuşulan
the spoken kalite...
quality...



www.akkо.com.tr

Дистрибьютер ООО "Ресурс Плюс"
+7 (351) 247-74-40; info@rp-ural.ru

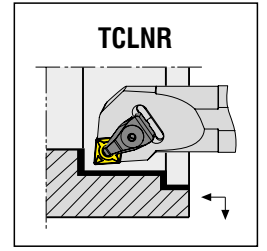
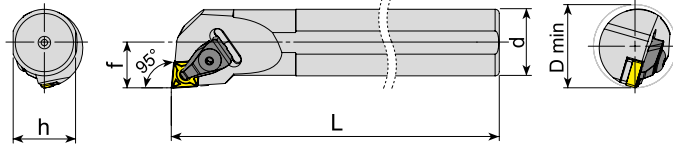

Takım Kodu Ordering Code	Stok Stock		Takım Ölçüleri (mm) Dimension (mm)				Kesici Uç Insert	Yedek Parçaları Spare Parts							
	R	L	d	h	L	f		D min	Baskı Pabucu Wedge Clamp	Pabuç Vidası Clamp Screw	Altık Shim	Altık Vidası Shim Screw	Yay Spring	Pul Stamp	Anahtar Allen Key
S25S TCLNR/L 09	●	●	25	23	250	17	≥32	CNM. 0903..	ATK-01	AKV-01-M5x22	AACN-2-0001	AAV-09-M5x9	-		
S25S TCLNR/L 12	●	●	25	23	250	17	≥32					AAV-13-M5x8			
S32T TCLNR/L 12	●	●	32	30	300	22	≥40	CNM. 1204..	ATK-02	AKV-02-M6x22	AACN-3-0001	AAV-02-M5x12	AKY-01	ABPL-01	AAL-03-3
S40U TCLNR/L 12	●	●	40	37.5	350	27	≥50								
S50V TCLNR/L 12	●	●	50	47	400	35	≥63								
S32T TCLNR/L 16	●	●	32	30	300	22	≥40	CNM. 1606..	ATK-04	AKV-19-M7x25	AACN-3-0002	AAV-05-M6x15	-	ABPL-02	AAL-05-4
S40U TCLNR/L 16	●	●	40	37.5	350	27	≥50								
S50V TCLNR/L 16	●	●	50	47	400	35	≥63								

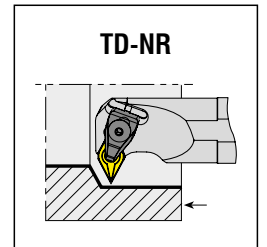
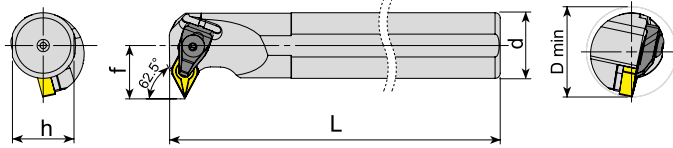

Takım Kodu Ordering Code	Stok Stock		Takım Ölçüleri (mm) Dimension (mm)				Kesici Uç Insert	Yedek Parçaları Spare Parts							
	R	L	d	h	L	f		D min	Baskı Pabucu Wedge Clamp	Pabuç Vidası Clamp Screw	Altık Shim	Altık Vidası Shim Screw	Yay Spring	Pul Stamp	Anahtar Allen Key
S32T TD-NR/L 15	●	●	32	30	300	26	≥44	DNM. 1506..	ATK-02	AKV-02-M6x22	AADN-3-0001	AAV-02-M5x12	AKY-01	ABPL-01	AAL-03-3
S40U TD-NR/L 15	●	●	40	37.5	350	29	≥52								
S50V TD-NR/L 15	●	●	50	47	400	35	≥63								

R: Sağ/Right L: Sol/Left ● Stokta/In Stock ○ Stokta Yok/Non Stock Item

Sipariş Örneği/Ordering Example : 1 ad./pcs. S25S TCLNR 09

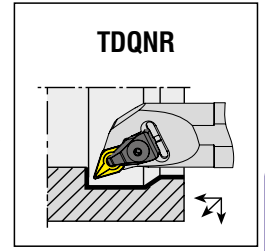
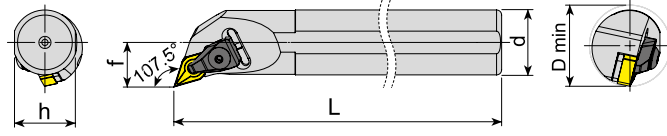

Takım Kodu Ordering Code	Stok Stock		Takım Ölçüleri (mm) Dimension (mm)					Kesici Uç Insert	Yedek Parçaları Spare Parts						
	R	L	d	h	L	f	D min		Baskı Pabucu Wedge Clamp	Pabuç Vidası Clamp Screw	Altlık Shim	Altlık Vidası Shim Screw	Yay Spring	Pul Stamp	Anahtar Allen Key
S25S TDQNR/L 11	●	●	25	23	250	17	≥32	DNM. 1104..	ATK-01	AKV-01-M5x22	AADN-2-0001	AAV-09-M5x9	-	ABPL-01	AAL-03-3
S32T TDQNR/L 11	●	●	32	30	300	22	≥40					AAV-04-M5x12			
S25S TDQNR/L 15	●	○	25	23	250	17	≥32	DNM. 1506..	ATK-02	AKV-02-M6x22	AADN-3-0001	AAV-13-M5x8	AKY-01	ABPL-01	AAL-03-3
S32T TDQNR/L 15	●	●	32	30	300	22	≥40					AAV-02-M5x12			
S40U TDQNR/L 15	●	●	40	37.5	350	27	≥50								
S50V TDQNR/L 15	●	●	50	47	400	35	≥63								

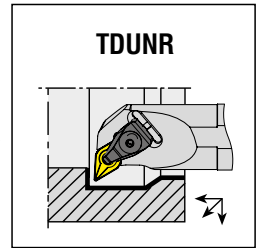
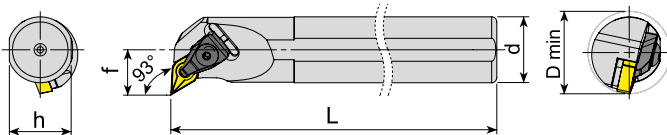

Takım Kodu Ordering Code	Stok Stock		Takım Ölçüleri (mm) Dimension (mm)					Kesici Uç Insert	Yedek Parçaları Spare Parts						
	R	L	d	h	L	f	D min		Baskı Pabucu Wedge Clamp	Pabuç Vidası Clamp Screw	Altlık Shim	Altlık Vidası Shim Screw	Yay Spring	Pul Stamp	Anahtar Allen Key
S25S TDUNR/L 11	●	●	25	23	250	17	≥32	DNM. 1104..	ATK-01	AKV-01-M5x22	AADN-2-0001	AAV-09-M5x9	-	ABPL-01	AAL-03-3
S32T TDUNR/L 11	●	●	32	30	300	22	≥40					AAV-04-M5x12			
S25S TDUNR/L 15	●	●	25	23	250	17	≥34	DNM. 1506..	ATK-02	AKV-02-M6x22	AADN-3-0001	AAV-13-M5x8	AKY-01	ABPL-01	AAL-03-3
S32T TDUNR/L 15	●	●	32	30	300	22	≥40					AAV-02-M5x12			
S40U TDUNR/L 15	●	●	40	37.5	350	27	≥50								
S50V TDUNR/L 15	●	●	50	47	400	35	≥63								

R: Sağ/Right L: Sol/Left ●Stokta/In Stock ○Stokta Yok/Non Stock Item

Sipariş Örneği/Ordering Example : 1 ad./pcs. S25S TDQNR 11

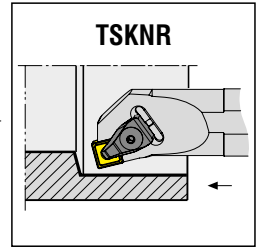
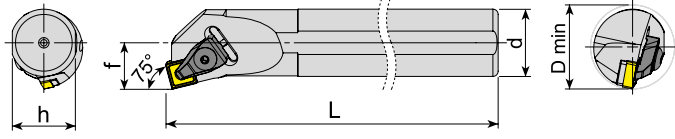

Takım Kodu Ordering Code	Stok Stock		Takım Ölçüleri (mm) Dimension (mm)				Kesici Uç Insert	Yedek Parçaları Spare Parts							
	R	L	d	h	L	f		D min	Baskı Pabucu Wedge Clamp	Pabuç Vidası Clamp Screw	Altılık Shim	Altılık Vidası Shim Screw	Yay Spring	Pul Stamp	Anahtar Allen Key
S25S TSKNR/L 12	●	●	25	23	250	17	≥32	SNM. 1204..	ATK-02	AKV-02-M6x22	AASN-3-0004	AAV-13-M5x8	AKY-01	ABPL-01	AAL-03-3
S32T TSKNR/L 12	●	●	32	30	300	22	≥40					AAV-02-M5x12			
S40U TSKNR/L 12	●	●	40	37.5	350	27	≥50								

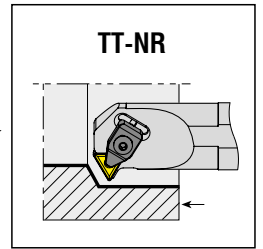
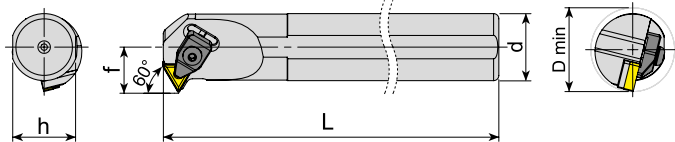

Takım Kodu Ordering Code	Stok Stock		Takım Ölçüleri (mm) Dimension (mm)				Kesici Uç Insert	Yedek Parçaları Spare Parts							
	R	L	d	h	L	f		D min	Baskı Pabucu Wedge Clamp	Pabuç Vidası Clamp Screw	Altılık Shim	Altılık Vidası Shim Screw	Yay Spring	Pul Stamp	Anahtar Allen Key
S25S TT-NR/L 16	●	●	25	23	250	17	≥32	TNM. 1604..	ATK-01	AKV-01-M5x22	AATN-2-0002	AAV-03-M5x12	-	ABPL-01	AAL-03-3
S32T TT-NR/L 16	●	●	32	30	300	22	≥40								

R: Sağ/Right L: Sol/Left ● Stokta/In Stock ○ Stokta Yok/Non Stock Item

Sipariş Örneği/Ordering Example : 1 ad./pcs. S25S TSKNR 12

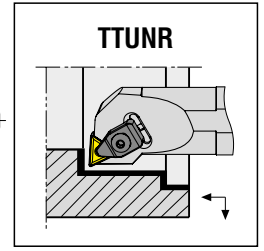
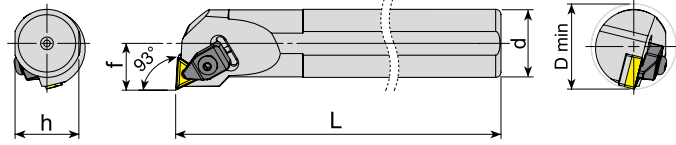

Takım Kodu Ordering Code	Stok Stock		Takım Ölçüleri (mm) Dimension (mm)				Kesici Uç Insert	Yedek Parçaları Spare Parts							
	R	L	d	h	L	f		D min	Baskı Pabucu Wedge Clamp	Pabuç Vidası Clamp Screw	Altlık Shim	Altlık Vidası Shim Screw	Yay Spring	Pul Stamp	Anahtar Allen Key
S25S TTUNR/L 16	●	●	25	23	250	17	≥32	TNM. 1604..	ATK-01	AKV-01-M5x22	AATN-2-0002	AAV-03-M5x12	-	ABPL-01	AAL-03-3
S32T TTUNR/L 16	●	●	32	30	300	22	≥40								
S25S TTUNR/L 22	●	●	25	23	250	17	≥32	TNM. 2204..	ATK-02	AKV-02-M6x22	AATN-3-0015	AAV-02-M5x12	AKY-01	ABPL-01	AAL-03-3
S32T TTUNR/L 22	●	●	32	30	300	22	≥40								
S40U TTUNR/L 22	●	●	40	37.5	350	27	≥50								
S50V TTUNR/L 22	●	●	50	47	400	35	≥63								

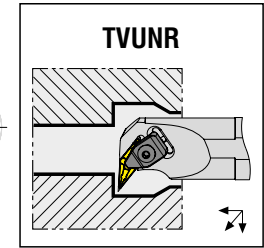
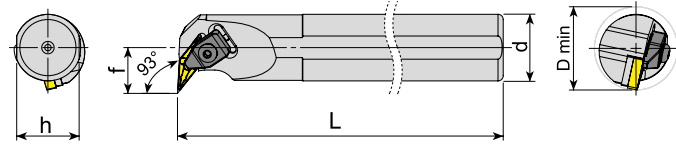

Takım Kodu Ordering Code	Stok Stock		Takım Ölçüleri (mm) Dimension (mm)				Kesici Uç Insert	Yedek Parçaları Spare Parts							
	R	L	d	h	L	f		D min	Baskı Pabucu Wedge Clamp	Pabuç Vidası Clamp Screw	Altlık Shim	Altlık Vidası Shim Screw	Yay Spring	Pul Stamp	Anahtar Allen Key
S25S TVUNR/L 16	●	●	25	23	250	20	≥36	VNM. 1604..	ATK-01	AKV-01-M5x22	AAVN-2-0002	AAV-04-M5x12	-	ABPL-01	AAL-03-3
S32T TVUNR/L 16	●	●	32	30	300	22	≥40								
S40U TVUNR/L 16	●	●	40	37.5	350	27	≥50								

R: Sağ/Right L: Sol/Left ●Stokta/In Stock ○Stokta Yok/Non Stock Item

Sipariş Örneği/Ordering Example : 1 ad./pcs. S25S TTUNR 16

➤ T-SİSTEM DELİK TORNA KATERLERİ
T-SYSTEM BORING BARS

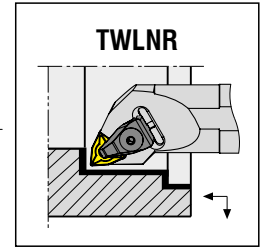
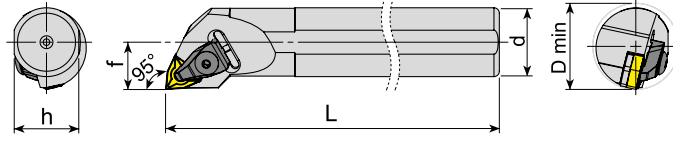

Takım Kodu Ordering Code	Stok Stock		Takım Ölçüleri (mm) Dimension (mm)				Kesici Uç Insert	Yedek Parçaları Spare Parts							
	R	L	d	h	L	f		D min	Baskı Pabucu Wedge Clamp	Pabuç Vidası Clamp Screw	Altılık Shim	Altılık Vidası Shim Screw	Yay Spring	Pul Stamp	Anahtar Allen Key
S25S TWLNR/L 06	●	●	25	23	250	17	≥32	WNM. 0604..	ATK-01	AKV-01-M5x22	AAWN-SW317	AAV-01-M3x10	-	ABPL-01	AAL-03-3
S32T TWLNR/L 06	●	●	32	30	300	22	≥40					AAV-13-M5x8			
S25S TWLNR/L 08	●	●	25	23	250	17	≥32	WNM. 0804..	ATK-02	AKV-02-M6x22	AAWN-3-0001	AAV-02-M5x12	AKY-01	ABPL-01	AAL-03-3
S32T TWLNR/L 08	●	●	32	30	300	22	≥40								
S40U TWLNR/L 08	●	●	40	37.5	350	27	≥50								
S50V TWLNR/L 08	●	●	50	47	400	35	≥63								

➤ C-SİSTEM DELİK TORNA KATERLERİ
C-SYSTEM BORING BARS

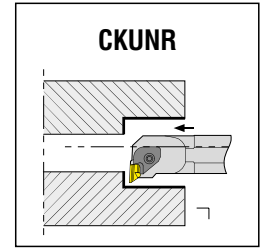
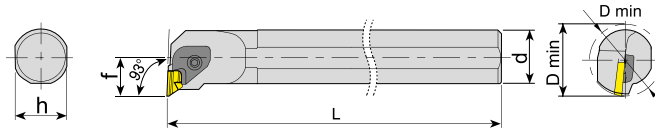

Takım Kodu Ordering Code	Stok Stock		Takım Ölçüleri (mm) Dimension (mm)				Kesici Uç Insert	Yedek Parçaları Spare Parts							
	R	L	d	h	L	f		D min	Baskı Pabucu Wedge Clamp	Pabuç Vidası Clamp Screw	Altılık Shim	Altılık Vidası Shim Screw	Yay Spring	Pul Stamp	Anahtar Allen Key
S25S CKUNR/L 16	●	●	25	23	250	19	≥38	KNUX 1604..	ACK-01-R ACK-02-L	AKV-06-M6x20	AKS-16-R AKS-16-L	AAV-01-M3x10	AKY-02	ABPL-01	AAL-05-4
S32T CKUNR/L 16	●	●	32	30	300	22	≥40								
S40U CKUNR/L 16	●	●	40	37.5	350	27	≥50								
S50V CKUNR/L 16	●	●	50	47	400	35	≥63								

R: Sağ/Right L: Sol/Left ● Stokta/In Stock ○ Stokta Yok/Non Stock Item

Sipariş Örneği/Ordering Example : 1 ad./pcs. S25S TWLNR 06

M-SİSTEM

M-SİSTEM DELİK TORNA KATERLERİ
M-SYSTEM BORING BARS

*konusulan
the spoken kalite...
quality...*



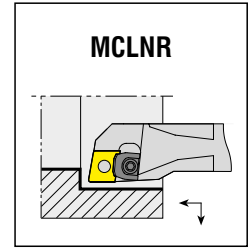
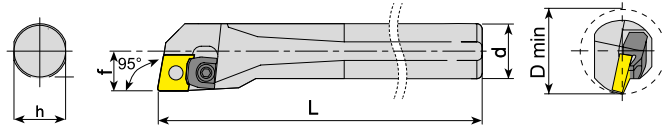

Takım Kodu Ordering Code	Stok Stock		Takım Ölçüleri (mm) Dimension (mm)					Kesici Uç Insert	Yedek Parçaları Spare Parts					
	R	L	d	h	L	f	D min		Baskı Pabucu Wedge Clamp	Pabuç Vidası Clamp Screw	Altlık Shim	Pim Pin	Pul Stamp	Anahtar Allen Key
S20R MCLNR/L 12	●●		20	18.3	200	13	≥25	CNM. 1204..	AMK-07		-	APM-12		
S25S MCLNR/L 12	●●		25	23	250	17	≥32		AMK-03	AKV-04-M5x17	AACN-3-0001	APM-13	-	AAL-03-3
S32T MCLNR/L 12	●●		32	30	300	22	≥40					APM-04		

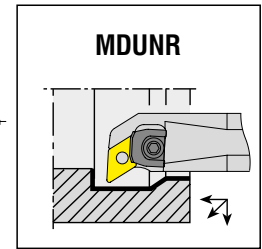
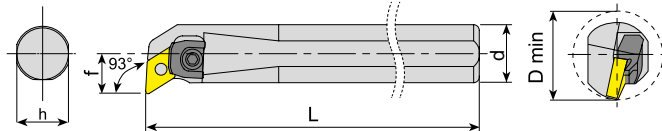

Takım Kodu Ordering Code	Stok Stock		Takım Ölçüleri (mm) Dimension (mm)					Kesici Uç Insert	Yedek Parçaları Spare Parts					
	R	L	d	h	L	f	D min		Baskı Pabucu Wedge Clamp	Pabuç Vidası Clamp Screw	Altlık Shim	Pim Pin	Pul Stamp	Anahtar Allen Key
S20R MDUNR/L 11	●●		20	18.3	200	13	≥25	DNM. 1104..		AKV-17-M5x15		APM-03		
S25S MDUNR/L 11	●●		25	23	250	17	≥32		AMK-03	AKV-04-M5x17	-		-	
S32T MDUNR/L 11	○	○	32	30	300	22	≥40							
S25S MDUNR/L 15	●●		25	23	250	17	≥32	DNM. 1506..		AKV-20-M6x19				
S32T MDUNR/L 15	●●		32	30	300	22	≥40		AMK-04	AKV-02-M6x22	AADN-3-0001	APM-04	ABPL-01	AAL-03-3
S40U MDUNR/L 15	●●		40	37.5	350	27	≥50							
S50V MDUNR/L 15	●●		50	47	400	35	≥63							

R: Sağ/Right L: Sol/Left ● Stokta/In Stock ○ Stokta Yok/Non Stock Item

Sipariş Örneği/Ordering Example : 1 ad./pcs. S20R MCLNR 12

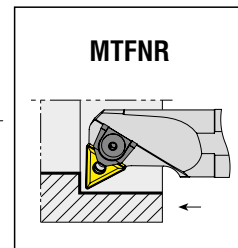
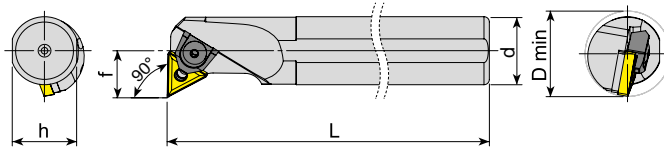

Takım Kodu Ordering Code	Stok Stock		Takım Ölçüleri (mm) Dimension (mm)					Kesici Uç Insert	Yedek Parçaları Spare Parts						
	R	L	d	h	L	f	D min		Baskı Pabucu Wedge Clamp	Pabuç Vidası Clamp Screw	Altlık Shim	Pim Pin	Pul Stamp	Anahtar Allen Key	
S20R MTFNR/L 16	●	●	20	18.3	200	14	≥25	TNM. 1604..	AMK-02	AKV-17-M5x15	-	APM-03	-	ABPL-01	AAL-03-3
S25S MTFNR/L 16	●	●	25	23	250	17	≥32		AATN-2-0002	AKV-02-M6x22	APM-14	APM-01			
S32T MTFNR/L 16	●	●	32	30	300	22	≥40								
S40U MTFNR/L 16	●	●	40	37.5	350	27	≥50								
S32T MTFNR/L 22	●	●	32	30	300	22	≥40	TNM. 2204..	AMK-04	AKV-02-M6x22	AATN-3-0015	APM-02			
S40U MTFNR/L 22	●	○	40	37.5	350	27	≥50								
S50V MTFNR/L 22	●	○	50	47	400	35	≥63								

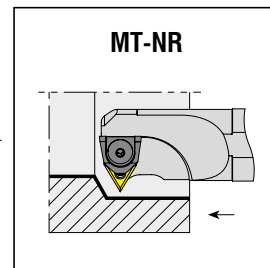
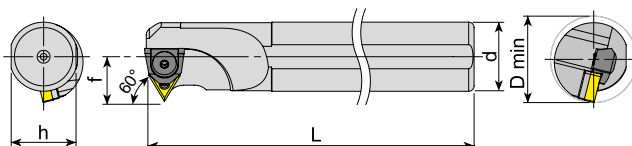

Takım Kodu Ordering Code	Stok Stock		Takım Ölçüleri (mm) Dimension (mm)					Kesici Uç Insert	Yedek Parçaları Spare Parts					
	R	L	d	h	L	f	D min		Baskı Pabucu Wedge Clamp	Pabuç Vidası Clamp Screw	Altlık Shim	Pim Pin	Pul Stamp	Anahtar Allen Key
S20R MT-NR/L 16	●	●	20	18.3	200	16	≥26	TNM. 1604..	AMK-02	AKV-04-M5x17	AATN-2-0002	APM-03	ABPL-01	AAL-03-3
S25S MT-NR/L 16	●	●	25	23	250	17	≥32					APM-14		
S32T MT-NR/L 16	●	●	32	30	300	22	≥40							
S40U MT-NR/L 16	●	●	40	37.5	350	27	≥50							
S32T MT-NR/L 22	●	●	32	30	300	24	≥40	TNM. 2204..	AMK-04	AKV-02-M6x22	AATN-3-0015	APM-02		
S40U MT-NR/L 22	●	●	40	37.5	350	27	≥50							
S50U MT-NR/L 22	●	○	50	47	350	35	≥63							

R: Sağ/Right L: Sol/Left ● Stokta/In Stock ○ Stokta Yok/Non Stock Item

Sipariş Örneği/Ordering Example : 1 ad./pcs. S20R MTFNR 16

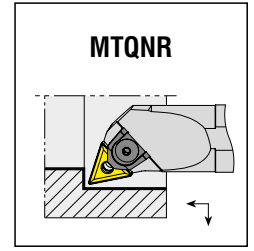
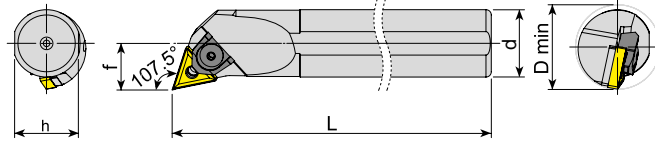

Takım Kodu Ordering Code	Stok Stock		Takım Ölçüleri (mm) Dimension (mm)					Kesici Uç Insert	Yedek Parçaları Spare Parts						
	R	L	d	h	L	f	D min		Baskı Pabucu Wedge Clamp	Pabuç Vidası Clamp Screw	Aitlik Shim	Pim Pin	Pul Stamp	Anahtar Allen Key	
S20R MTQNR/L 16	●	●	20	18.3	200	13	≥25	TNM. 1604..	AMK-02	AKV-17-M5x15	-	APM-11	-	ABPL-01	AAL-03-3
S25S MTQNR/L 16	●	●	25	23	250	17	≥32				AATN-2-0002	APM-14			
S32T MTQNR/L 16	●	●	32	30	300	22	≥40					APM-01			
S40U MTQNR/L 16	●	●	40	37.5	350	27	≥50		AMK-04	AKV-02-M6x22					
S32T MTQNR/L 22	●	●	32	30	300	22	≥40	TNM. 2204..			AATN-3-0015	APM-02			
S40U MTQNR/L 22	●	●	40	37.5	350	27	≥50								
S50V MTQNR/L 22	●	●	50	47	400	35	≥63								

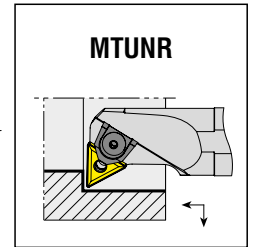
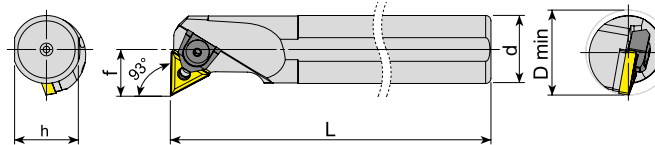

Takım Kodu Ordering Code	Stok Stock		Takım Ölçüleri (mm) Dimension (mm)					Kesici Uç Insert	Yedek Parçaları Spare Parts						
	R	L	d	h	L	f	D min		Baskı Pabucu Wedge Clamp	Pabuç Vidası Clamp Screw	Aitlik Shim	Pim Pin	Pul Stamp	Anahtar Allen Key	
S20R MTUNR/L 16	●	●	20	18.3	200	13	≥25	TNM. 1604..	AMK-02	AKV-17-M5x15	-	APM-03	-	ABPL-01	AAL-03-3
S25S MTUNR/L 16	●	●	25	23	250	17	≥32				AATN-2-0002	APM-14			
S32T MTUNR/L 16	●	●	32	30	300	22	≥40					APM-01			
S40U MTUNR/L 16	●	●	40	37.5	350	27	≥50		AMK-04	AKV-02-M6x22					
S50V MTUNR/L 16	●	○	50	47	400	35	≥63	TNM. 2204..			AATN-3-0015	APM-02			
S32T MTUNR/L 22	●	●	32	30	300	22	≥40								
S40U MTUNR/L 22	●	●	40	37.5	350	27	≥50								
S50V MTUNR/L 22	●	●	50	47	400	35	≥63								

R: Sağ/Right L: Sol/Left ● Stokta/In Stock ○ Stokta Yok/Non Stock Item

Sipariş Örneği/Ordering Example : 1 ad./pcs. S20R MTQNR 16

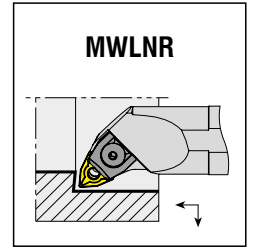
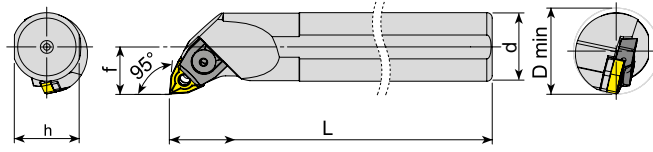

Takım Kodu Ordering Code	Stok Stock		Takım Ölçüleri (mm) Dimension (mm)					Kesici Uç Insert	Yedek Parçaları Spare Parts						
	R	L	d	h	L	f	D min		Baskı Pabucu Wedge Clamp	Pabuç Vidası Clamp Screw	Altlık Shim	Pim Pin	Pul Stamp	Anahtar Allen Key	
S16P MWLNR/L 06	●	●	16	14.8	170	11	≥20	WNM. 0604..		AKV-17-M5x15	-	APM-09	-	AAL-03-3	
S20R MWLNR/L 06	●	●	20	18.3	200	13	≥25					AKV-04-M5x17			APM-10
S25S MWLNR/L 06	●	●	25	23	250	17	≥32					AKV-27-M6x20			APM-08
S25S MWLNR/L 08	●	●	25	23	250	17	≥32	WNM. 0804..	AMK-05	AKV-03-M6x22	AAWN-3-0001	APM-04	ABPL-01		
S32T MWLNR/L 08	●	●	32	30	300	22	≥40					APM-02			
S40U MWLNR/L 08	●	●	40	37.5	350	27	≥50								

R: Sağ/Right L: Sol/Left ● Stokta/In Stock ○ Stokta Yok/Non Stock Item

Sipariş Örneği/Ordering Example : 1 ad./pcs. S16P MWLNR 06





*konusulan
the spoken kalite...
quality...*

P-SİSTEM

P-SİSTEM DELİK TORNA KATERLERİ
P-SYSTEM BORING BARS



www.akkо.com.tr

Дистрибьютер ООО "Ресурс Плюс"
+7 (351) 247-74-40; info@rp-ural.ru

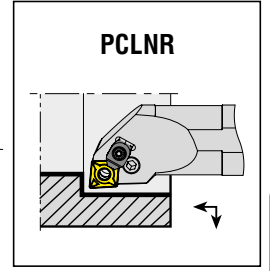
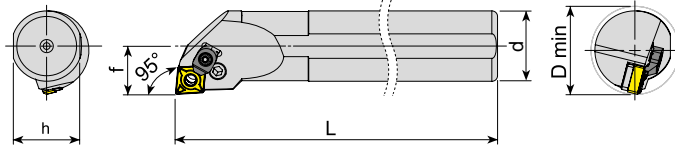

Takım Kodu Ordering Code	Stok Stock		Takım Ölçüleri (mm) Dimension (mm)				Kesici Uç Insert	Yedek Parçaları Spare Parts								
	R	L	d	h	L	f		D min	Levye Lever	Levye Vidası Lever Screw	Altlık Shim	Altlık Yayı Shim Spring	Baskı Parçası Wedge Clamp	Baskı Vidası Clamp Screw	Anahtar Allen Key	
S16P PCLNR/L 09	●	●	16	14.8	170	11	≥20	CNM. 0903..	APL-07	ALV-07-M6x13	-	-	-	-	-	-
S20R PCLNR/L 09	●	●	20	18.3	200	13	≥25		APL-01	ALV-01-M6x14	AACN-2-0002	AAY-01	-	-	-	-
S25S PCLNR/L 09	○	○	25	23	250	17	≥32	CNM. 1204..	APL-02	ALV-08-M8x16	AACN-3-0001	AAY-02	ACK-05	1515-M4x11	AAL-03-3	
S25S PCLNR/L 12C	●	●	25	23	250	17	≥32			ALV-03-M8x19						
S32T PCLNR/L 12C	●	●	32	30	300	22	≥40	CNM. 1606..	APL-04	ALV-04-M8x22	AACN-3-0002	AAY-03	ACK-09	AAV-05-M6x15	AAL-05-4	
S40U PCLNR/L 12C	●	●	40	37.5	350	27	≥50									
S50V PCLNR/L 12C	●	●	50	47	400	35	≥63	CNM. 1906..	APL-05	ALV-05-M10x27	AACN-3-0003	AAY-04	ACK-09	AAV-05-M6x15	AAL-05-4	
S32T PCLNR/L 16C	●	●	32	30	300	22	≥40									
S40U PCLNR/L 16C	●	●	40	37.5	350	27	≥50	CNM. 1204..	APL-02	ALV-03-M8x19	AACN-3-0001	AAY-02	ACK-05	1515-M4x11	AAL-03-3	
S50V PCLNR/L 16C	●	●	50	47	400	35	≥63									
S40U PCLNR/L 19C	●	●	40	37.5	350	27	≥50	CNM. 1606..	APL-04	ALV-04-M8x22	AACN-3-0002	AAY-03	ACK-09	AAV-05-M6x15	AAL-05-4	
S50V PCLNR/L 19C	●	●	50	47	400	35	≥63									
A25R PCLNR/L 12C	●	●	25	23	200	17	≥32	CNM. 1906..	APL-05	ALV-05-M10x27	AACN-3-0003	AAY-04	ACK-09	AAV-05-M6x15	AAL-05-4	
A32S PCLNR/L 12C	●	●	32	30	250	22	≥40									
A40T PCLNR/L 12C	●	●	40	37.5	300	27	≥50	CNM. 1204..	APL-02	ALV-03-M8x19	AACN-3-0001	AAY-02	ACK-05	1515-M4x11	AAL-03-3	
A50U PCLNR/L 12C	●	●	50	47	350	35	≥63									
A32S PCLNR/L 16C	●	●	32	30	250	22	≥40	CNM. 1606..	APL-04	ALV-04-M8x22	AACN-3-0002	AAY-03	ACK-09	AAV-05-M6x15	AAL-05-4	
A40T PCLNR/L 16C	●	●	40	37.5	300	27	≥50									
A50U PCLNR/L 16C	●	●	50	47	350	35	≥63	CNM. 1906..	APL-05	ALV-05-M10x27	AACN-3-0003	AAY-04	ACK-09	AAV-05-M6x15	AAL-05-4	
A40T PCLNR/L 19C	●	●	40	37.5	300	27	≥50									
A50U PCLNR/L 19C	●	●	50	47	350	35	≥63									

R: Sağ/Right L: Sol/Left ● Stokta/In Stock ○ Stokta Yok/Non Stock Item

Sipariş Örneği/Ordering Example : 1 ad./pcs. S16P PCLNR 09

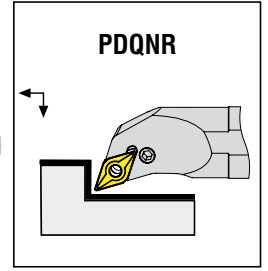
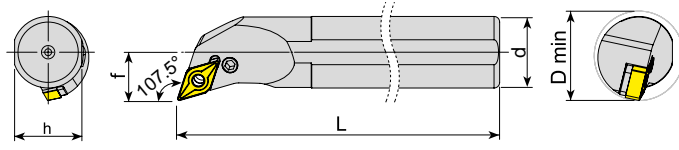

Takım Kodu Ordering Code	Stok Stock		Takım Ölçüleri (mm) Dimension (mm)					Kesici Uç Insert	Yedek Parçaları Spare Parts						
	R	L	d	h	L	f	D min		Levyeye Lever	Levyeye Vidası Lever Screw	Altılık Shim	Altılık Yayı Shim Spring	Baskı Parçası Wedge Clamp	Baskı Vidası Clamp Screw	Anahtar Allen Key
	●	○													
S20R PDQNR/L 11	○	○	20	18.3	200	13	≥25	DNM. 1104..	APL-01	ALV-01-M6x14 ALV-02-M6x17	AADN-SD317	AAAY-01			AAL-02-2.5
S25S PDQNR/L 11	●	●	25	23	250	17	≥32								
S32T PDQNR/L 15	●	●	32	30	300	22	≥40	DNM. 1506..	APL-03	ALV-03-M8x19	AADN-3-0001	AAAY-02	-	-	AAL-03-3
S40U PDQNR/L 15	●	●	40	37.5	350	27	≥50								
S50V PDQNR/L 15	●	●	50	47	400	35	≥63	DNM. 1504..	APL-03	ALV-03-M8x19	AADN-2-0003	AAAY-02	-	-	AAL-03-3
S32T PDQNR/L 1504	●	●	32	30	300	22	≥40								
S40U PDQNR/L 1504	●	●	40	37.5	350	27	≥50	DNM. 1506..	APL-03	ALV-03-M8x19	AADN-3-0001	AAAY-02	-	-	AAL-03-3
S50V PDQNR/L 1504	●	●	50	47	400	35	≥63								
A20P PDQNR/L 11	●	●	20	18.3	170	13	≥25	DNM. 1104..	APL-01	ALV-01-M6x14 ALV-02-M6x17	AADN-SD317	AAAY-01	-	-	AAL-02-2.5
A25R PDQNR/L 11	●	●	25	23	200	17	≥32								
A32S PDQNR/L 15	●	●	32	30	250	22	≥40	DNM. 1506..	APL-03	ALV-03-M8x19	AADN-3-0001	AAAY-02	-	-	AAL-03-3
A40T PDQNR/L 15	●	●	40	37.5	300	27	≥50								
A50U PDQNR/L 15	●	●	50	47	350	35	≥63	DNM. 1504..	APL-03	ALV-03-M8x19	AADN-2-0003	AAAY-02	-	-	AAL-03-3
A32S PDQNR/L 1504	●	○	32	30	250	22	≥40								
A40T PDQNR/L 1504	●	○	40	37.5	300	27	≥50								

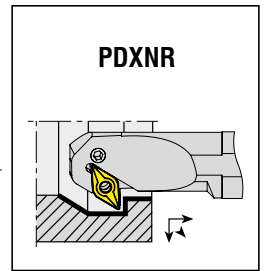
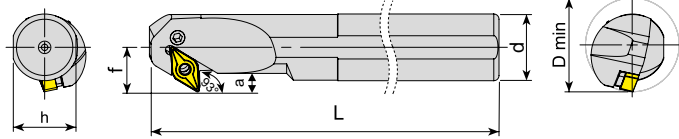

Takım Kodu Ordering Code	Stok Stock		Takım Ölçüleri (mm) Dimension (mm)						Kesici Uç Insert	Yedek Parçaları Spare Parts						
	R	L	d	h	L	f	a	D min		Levyeye Lever	Levyeye Vidası Lever Screw	Altılık Shim	Altılık Yayı Shim Spring	Baskı Parçası Wedge Clamp	Baskı Vidası Clamp Screw	Anahtar Allen Key
	●	○														
S32T PDXNR/L 15	●	●	32	30	300	25	12	≥45	DNM. 1506..	APL-03	ALV-08-M8x16 ALV-03-M8x19	AADN-3-0001	AAAY-02	-	-	AAL-03-3
S40U PDXNR/L 15	●	●	40	37.5	350	27	14	≥50								
S50V PDXNR/L 15	●	●	50	47	400	35	19	≥63								

R: Sağ/Right L: Sol/Left ● Stokta/In Stock ○ Stokta Yok/Non Stock Item
Not: "a" ölçüleri R0.8'e göre verilmiştir.
Note: Dimensions of "a" are given according to R.08.

Sipariş Örneği/Ordering Example : 1 ad./pcs. S20R PDQNR 11

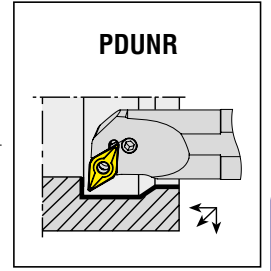
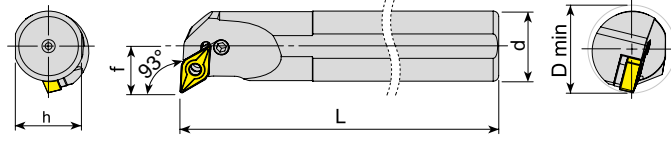

Takım Kodu Ordering Code	Stok Stock		Takım Ölçüleri (mm) Dimension (mm)				Kesici Uç Insert	Yedek Parçaları Spare Parts							
	R	L	d	h	L	f		D min	Levyeye Lever	Levyeye Vidası Lever Screw	Altılık Shim	Altılık Yayı Shim Spring	Baskı Parçası Wedge Clamp	Baskı Vidası Clamp Screw	Anahtar Allen Key
S20R PDUNR/L 11	●	●	20	18.3	200	13	≥25	DNM. 1104..	APL-01	ALV-01-M6x14	AADN-SD317	AAY-01	-	-	AAL-02-2.5
S25S PDUNR/L 11	●	●	25	23	250	17	≥32			ALV-02-M6x17					
S25S PDUNR/L 15	●	●	25	23	250	19	≥32	DNM. 1506..	APL-03	ALV-08-M8x16	AADN-3-0001	AAY-02	-	-	AAL-03-3
S32T PDUNR/L 15	●	●	32	30	300	22	≥40			ALV-03-M8x19					
S40U PDUNR/L 15	●	●	40	37.5	350	27	≥50	DNM. 1104..	APL-01	ALV-01-M6x14	AADN-SD317	AAY-01	-	-	AAL-02-2.5
S50V PDUNR/L 15	●	●	50	47	400	35	≥63			ALV-02-M6x17					
A20P PDUNR/L 11	●	○	20	18.3	170	13	≥25	DNM. 1506..	APL-03	ALV-03-M8x19	AADN-3-0001	AAY-02	-	-	AAL-03-3
A25R PDUNR/L 11	●	○	25	23	200	17	≥32			ALV-03-M8x19					
A32S PDUNR/L 11	●	○	32	30	250	22	≥40	DNM. 1104..	APL-01	ALV-01-M6x14	AADN-SD317	AAY-01	-	-	AAL-02-2.5
A32S PDUNR/L 15	●	○	32	30	250	22	≥40			ALV-02-M6x17					
A40T PDUNR/L 15	●	○	40	37.5	300	27	≥50	DNM. 1506..	APL-03	ALV-03-M8x19	AADN-3-0001	AAY-02	-	-	AAL-03-3
A50U PDUNR/L 15	●	○	50	47	350	35	≥63			ALV-03-M8x19					

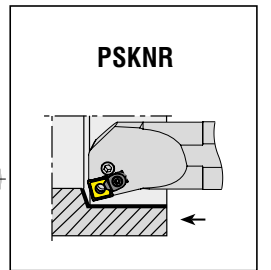
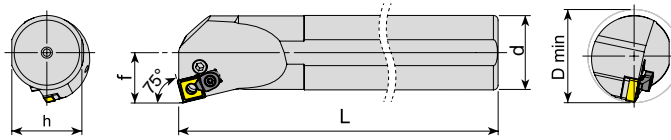

Takım Kodu Ordering Code	Stok Stock		Takım Ölçüleri (mm) Dimension (mm)				Kesici Uç Insert	Yedek Parçaları Spare Parts							
	R	L	d	h	L	f		D min	Levyeye Lever	Levyeye Vidası Lever Screw	Altılık Shim	Altılık Yayı Shim Spring	Baskı Parçası Wedge Clamp	Baskı Vidası Clamp Screw	Anahtar Allen Key
S25S PSKNR/L 12C	●	●	25	23	250	17	≥32	SNM. 1204..	APL-02	ALV-08-M8x16	AASN-3-0004	AAY-02	ACK-05	1515-M4x11	AAL-03-3
S32T PSKNR/L 12C	●	●	32	30	300	22	≥40			ALV-03-M8x19					
S40U PSKNR/L 12C	●	●	40	37.5	350	27	≥50			ALV-03-M8x19					
S50V PSKNR/L 12C	●	●	50	47	400	35	≥63	SNM. 1506..	APL-04	ALV-04-M8x22	AASN-3-0023	AAY-03	-	-	AAL-05-4
S32T PSKNR/L 15	○	○	32	30	300	22	≥40			ALV-04-M8x22					
S40U PSKNR/L 15	○	○	40	37.5	350	27	≥50			ALV-04-M8x22					
S50V PSKNR/L 15	○	○	50	47	400	35	≥63			ALV-04-M8x22					

R: Sağ/Right L: Sol/Left ● Stokta/In Stock ○ Stokta Yok/Non Stock Item

Sipariş Örneği/Ordering Example : 1 ad./pcs. S20R PDUNR 11

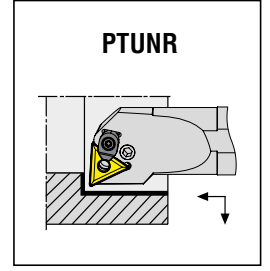
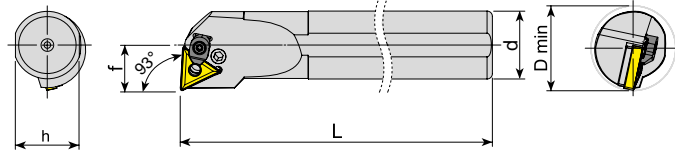

Takım Kodu Ordering Code	Stok Stock		Takım Ölçüleri (mm) Dimension (mm)				Kesici Uç Insert	Yedek Parçaları Spare Parts									
	R	L	d	h	L	f		D min	Levye Lever	Levye Vidası Lever Screw	Altlık Shim	Altlık Yayı Shim Spring	Baskı Parçası Wedge Clamp	Baskı Vidası Clamp Screw	Anahtar Allen Key		
S16P PTUNR/L 16	●	●	16	14.8	170	11	≥20	TNM. 1604..	APL-08	ALV-07-M6x13	-	-	-	-	AAL-02-2.5		
S20R PTUNR/L 16	●	●	20	18.3	200	13	≥25		APL-01	ALV-01-M6x14	AATN-3-0025	AAY-01					
S25S PTUNR/L 16C	●	●	25	23	250	17	≥32			ALV-02-M6x17							
S32T PTUNR/L 16C	●	●	32	30	300	22	≥40										
S40U PTUNR/L 16C	●	●	40	37.5	350	27	≥50										
S32T PTUNR/L 22C	●	●	32	30	300	22	≥40	TNM. 2204..	APL-02	ALV-03-M8x19	AATN-3-0015	AAY-02	ACK-05	1515-M4x11	AAL-03-3		
S40U PTUNR/L 22C	●	●	40	37.5	350	27	≥50										
S50V PTUNR/L 22C	●	●	50	47	400	35	≥63										

R: Sağ/Right L: Sol/Left ● Stokta/In Stock ○ Stokta Yok/Non Stock Item

Sipariş Örneği/Ordering Example : 1 ad./pcs. S16P PTUNR 16



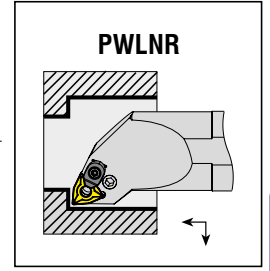
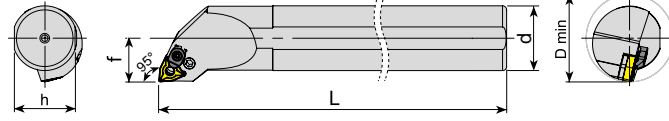

Takım Kodu Ordering Code	Stok Stock		Takım Ölçüleri (mm) Dimension (mm)				Kesici Uç Insert	Yedek Parçaları Spare Parts							
	R	L	d	h	L	f		D min	Levyeye Lever	Levyeye Vidası Lever Screw	Altılık Shim	Altılık Yayı Shim Spring	Baskı Parçası Wedge Clamp	Baskı Vidası Clamp Screw	Anahtar Allen Key
S20R PWLNR/L 06	●	●	20	18.3	200	13	≥25	WNM. 0604..	APL-01	ALV-01-M6x14 ALV-02-M6x17	AAWN-SW317	AAY-01	-	-	AAL-02-2.5
S25S PWLNR/L 06	●	●	25	23	250	17	≥32								
S32T PWLNR/L 06	●	●	32	30	300	22	≥40								
S25S PWLNR/L 08C	●	●	25	23	250	17	≥32	WNM. 0804..	APL-02	ALV-03-M8x19	AAWN-3-0001	AAY-02	ACK-05	1515-M4x11	AAL-03-3
S32T PWLNR/L 08C	●	●	32	30	300	22	≥40								
S40U PWLNR/L 08C	●	●	40	37.5	350	27	≥50								
S50V PWLNR/L 08C	●	●	50	47	400	35	≥63	WNM. 0604..	APL-01	ALV-01-M6x14 ALV-02-M6x17	AAWN-SW317	AAY-01	-	-	AAL-02-2.5
A20P PWLNR/L 06	●	●	20	18.3	170	13	≥25								
A25R PWLNR/L 06	●	●	25	23	200	17	≥32								
A32S PWLNR/L 06	●	●	32	30	250	22	≥40	WNM. 0804..	APL-02	ALV-03-M8x19	AAWN-3-0001	AAY-02	ACK-05	1515-M4x11	AAL-03-3
A25R PWLNR/L 08C	●	●	25	23	200	17	≥32								
A32S PWLNR/L 08C	●	●	32	30	250	22	≥40								
A40T PWLNR/L 08C	●	●	40	37.5	300	27	≥50	WNM. 0804..	APL-02	ALV-03-M8x19	AAWN-3-0001	AAY-02	ACK-05	1515-M4x11	AAL-03-3
A50U PWLNR/L 08C	●	●	50	47	350	35	≥63								

R: Sağ/Right L: Sol/Left ● Stokta/In Stock ○ Stokta Yok/Non Stock Item

Sipariş Örneği/Ordering Example : 1 ad./pcs. S20R PWLNR 06





*konusulan
the spoken kalite...
quality...*

S-SİSTEM

S-SİSTEM DELİK TORNA KATERLERİ
S-SYSTEM BORING BARS



www.akkо.com.tr

Дистрибутор ООО "Ресурс Плюс"
+7 (351) 247-74-40; info@rp-ural.ru

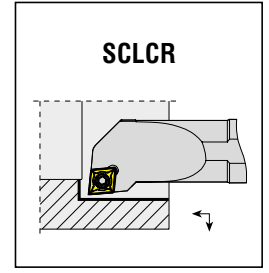
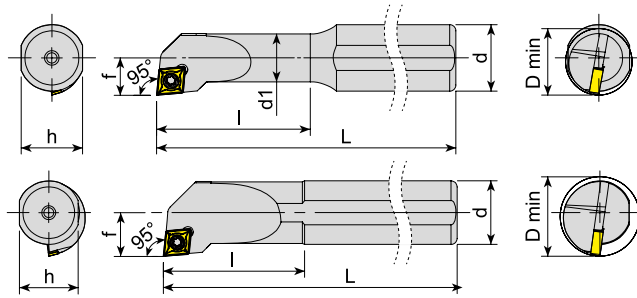

Takım Kodu Ordering Code	Stok Stock		Takım Ölçüleri (mm) Dimension (mm)						Kesici Uç Insert	Yedek Parçaları Spare Parts				
	R	L	d	d1	h	l	L	f		D min	Sıkma Vidası Screw	Aitlik Shim	Aitlik Vidası Shim Screw	Tork Anahtar Torx Key
S0608H SCLCR/L 03	●	○	08	5	7.3	18	100	3	≥6	CC.T 030102	4006-M1.6x3.2			80-T06
S0608H SCLCR/L 06	●	●	08	6	7.3	25	100	4.5	≥8		4008-M2.5x4.5			
S08H SCLCR/L 06	●	●	08	8	7.3	20	100	06	≥11	CC.T 0602..	4008-M2.5x6	-	-	80-T08
S10K SCLCR/L 06	●	●	10	10	09	25	125	07	≥13					
S12K SCLCR/L 06	●	●	12	12	11	25	125	09	≥16					
S1216P SCLCR/L 06	●	○	16	11.5	14.8	37	170	09	≥16	CC.T 09T3..	4015-M3.5x8			80-T15
S16P SCLCR/L 06	●	●	16	16	14.8	35	170	11	≥20		4015-M3.5x9	-	-	
S12K SCLCR/L 09	●	●	12	12	11	30	125	09	≥16	CC.T 09T3..	4015-M3.5x12	AACN-2-0001	AAV-08-M3.5x8	80-T20
S1416P SCLCR/L 09	●	●	16	14	14.8	45	170	9.5	≥17		4020-M4.5x12	AACN-2-0003	AAV-10-M4.5x8	
S16P SCLCR/L 09	●	●	16	16	14.8	35	170	11	≥20		1020-M4.5x16		AAV-07-M4.5x13	
S1620R SCLCR/L 09	●	●	20	16	18.3	50	200	11	≥20	CC.T 1204..	4015-M3.5x9	-	-	80-T15
S20R SCLCR/L 09	●	●	20	20	18.3	40	200	13	≥25		4015-M3.5x12	AACN-2-0001	AAV-08-M3.5x8	
S25S SCLCR/L 09	●	●	25	25	23	50	250	17	≥32	CC.T 1204..	4020-M4.5x12	AACN-2-0003	AAV-10-M4.5x8	80-T20
S32T SCLCR/L 09	●	●	32	32	30	60	300	22	≥40		1020-M4.5x16		AAV-07-M4.5x13	
S25S SCLCR/L 12	●	●	25	25	23	50	250	17	≥32					
S32T SCLCR/L 12	●	●	32	32	30	60	300	22	≥40	CC.T 0602..	4008-M2.5x6	-	-	80-T08
S40U SCLCR/L 12	●	●	40	40	37.5	70	350	27	≥50					
A08H SCLCR/L 06	●	●	08	8	7.3	20	100	06	≥11	CC.T 09T3..	4015-M3.5x9	-	-	80-T15
A10H SCLCR/L 06	●	●	10	10	09	25	100	07	≥13		4015-M3.5x12	AACN-2-0001	AAV-08-M3.5x8	
A12H SCLCR/L 06	●	●	12	12	11	25	100	09	≥16		4015-M3.5x12	AACN-2-0001	AAV-08-M3.5x8	
A16M SCLCR/L 09	●	●	16	16	14.8	35	150	11	≥20	CC.T 1204..	4020-M4.5x12	AACN-2-0003	AAV-10-M4.5x8	80-T20
A20P SCLCR/L 09	●	●	20	20	18.3	40	170	13	≥25					
A25R SCLCR/L 09	●	●	25	25	23	50	200	17	≥32					
A32S SCLCR/L 09	●	●	32	32	30	60	250	22	≥40					
A25R SCLCR/L 12	●	●	25	25	23	50	200	17	≥32					

R: Sağ/Right L: Sol/Left ● Stokta/In Stock ○ Stokta Yok/Non Stock Item

Sipariş Örneği/Ordering Example : 1 ad./pcs. S0608H SCLCR 06

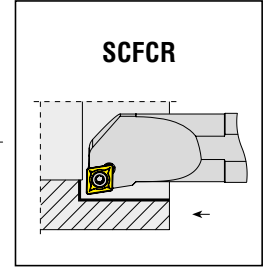
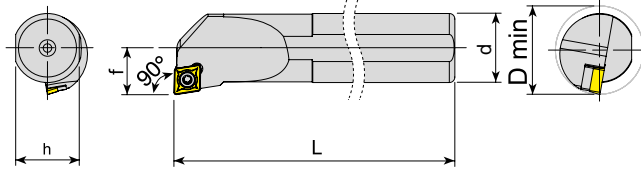

Takım Kodu Ordering Code	Stok Stock		Takım Ölçüleri (mm) Dimension (mm)					Kesici Uç Insert	Yedek Parçaları Spare Parts			
	R	L	d	h	L	f	D min		Sıkma Vidası Screw	Altlık Shim	Altlık Vidası Shim Screw	Tork Anahtar Torx Key
S08H SCFCR/L 06	●	●	08	7.3	100	06	≥11	CC.T 0602..	4008-M2.5x6	-	-	80-T08
S10K SCFCR/L 06	●	●	10	09	125	07	≥13					
S12K SCFCR/L 06	●	●	12	11	125	09	≥16					
S12K SCFCR/L 09	●	●	12	11	125	09	≥16	CC.T 09T3..	4015-M3.5x8	-	-	80-T15
S16P SCFCR/L 09	●	●	16	14.8	170	11	≥20					
S20R SCFCR/L 09	●	●	20	18.3	200	13	≥25					
S25S SCFCR/L 09	●	●	25	23	250	17	≥32	CC.T 1204..	4015-M3.5x12	AACN-2-0001	AAV-08-M3.5x8	80-T20
S25S SCFCR/L 12	○	○	25	23	250	17	≥32					
S32T SCFCR/L 12	○	○	32	30	300	22	≥40					
S40U SCFCR/L 12	○	○	40	37.5	350	27	≥50		4020-M4.5x12	AACN-2-0003	AAV-10-M4.5x8	
									1020-M4.5x16		AAV-07-M4.5x13	

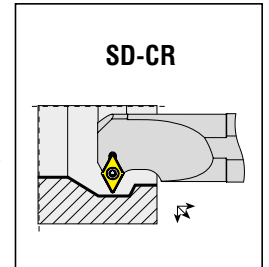
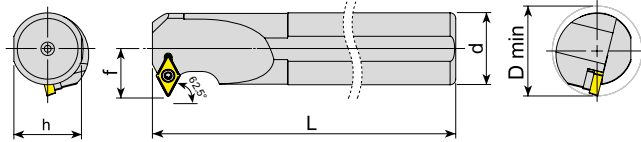

Takım Kodu Ordering Code	Stok Stock		Takım Ölçüleri (mm) Dimension (mm)					Kesici Uç Insert	Yedek Parçaları Spare Parts			
	R	L	d	h	L	f	D min		Sıkma Vidası Screw	Altlık Shim	Altlık Vidası Shim Screw	Tork Anahtar Torx Key
S10K SD-CR/L 07	●	●	10	9	125	07	≥13	DC.T 0702..	4008-M2.5x6	-	-	80-T08
S12K SD-CR/L 07	●	●	12	11	125	09	≥16					
S16P SD-CR/L 07	●	●	16	14.8	170	11	≥20					
S20R SD-CR/L 07	○	○	20	18.3	200	13	≥25	DC.T 11T3..	4015-M3.5x11	-	-	80-T15
S16P SD-CR/L 11	●	●	16	14.8	170	14	≥22					
S20R SD-CR/L 11	●	●	20	18.3	200	15	≥25					
S25S SD-CR/L 11	●	●	25	23	250	18	≥32		4015-M3.5x14	AADN-2-0001	AAV-06-M3.5x11	
S32T SD-CR/L 11	●	●	32	30	300	22	≥40					
S40U SD-CR/L 11	●	●	40	37.5	350	27	≥50					

R: Sağ/Right L: Sol/Left ● Stokta/In Stock ○ Stokta Yok/Non Stock Item

Sipariş Örneği/Ordering Example : 1 ad./pcs. S08H SCFCR 06

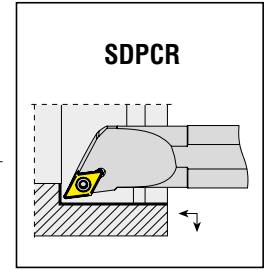
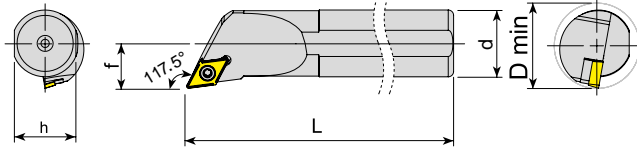

Takım Kodu Ordering Code	Stok Stock		Takım Ölçüleri (mm) Dimension (mm)				Kesici Uç Insert	Yedek Parçaları Spare Parts				
	R	L	d	h	L	f		D min	Sıkma Vidası Screw	Altılık Shim	Altılık Vidası Shim Screw	Tork Anahtar Torx Key
S10K SDPCR/L 07	●	●	10	09	125	07	≥13	DC.T 0702..	4008-M2.5x6	-	-	80-T08
S12K SDPCR/L 07	●	●	12	11	125	09	≥16					
S16P SDPCR/L 11	●	●	16	14.8	170	11	≥20	DC.T 11T3..	4015-M3.5x9	-	-	80-T15
S20R SDPCR/L 11	●	●	20	18.3	200	13	≥25		4015-M3.5x11			
S25S SDPCR/L 11	●	●	25	23	250	17	≥32		4015-M3.5x12			

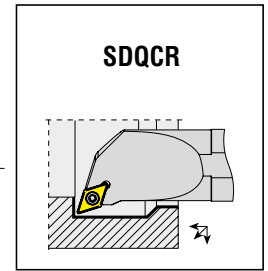
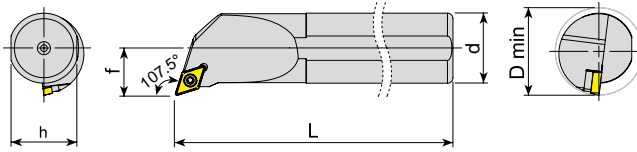

Takım Kodu Ordering Code	Stok Stock		Takım Ölçüleri (mm) Dimension (mm)				Kesici Uç Insert	Yedek Parçaları Spare Parts					
	R	L	d	h	L	f		D min	Sıkma Vidası Screw	Altılık Shim	Altılık Vidası Shim Screw	Tork Anahtar Torx Key	
S10K SDQCR/L 07	●	●	10	09	125	07	≥13	DC.T 0702..	4008-M2.5x6	-	-	80-T08	
S12K SDQCR/L 07	●	●	12	11	125	09	≥16						
S16P SDQCR/L 07	●	●	16	14.8	170	11	≥20	DC.T 11T3..	4015-M3.5x9	-	-	80-T15	
S20R SDQCR/L 07	●	●	20	18.3	200	13	≥25		4015-M3.5x11				
S16P SDQCR/L 11	●	●	16	14.8	170	11	≥20		4015-M3.5x12				AADN-2-0001
S20R SDQCR/L 11	●	●	20	18.3	200	13	≥25	4015-M3.5x14	-	-	80-T15		
S25S SDQCR/L 11	●	●	25	23	250	17	≥32						
S32T SDQCR/L 11	●	●	32	30	300	22	≥40	DC.T 0702..	4008-M2.5x6	-	-	80-T08	
S40U SDQCR/L 11	●	●	40	37.5	350	27	≥50						
A10H SDQCR/L 07	●	●	10	09	100	07	≥13	DC.T 0702..	4008-M2.5x6	-	-	80-T08	
A12H SDQCR/L 07	●	●	12	11	100	09	≥16						
A16M SDQCR/L 07	●	●	16	14.8	150	11	≥20	DC.T 11T3..	4015-M3.5x9	-	-	80-T15	
A20P SDQCR/L 07	●	●	20	18.3	170	13	≥25						4015-M3.5x11
A16M SDQCR/L 11	●	●	16	14.8	150	11	≥20						4015-M3.5x12
A20P SDQCR/L 11	●	●	20	18.3	170	13	≥25	4015-M3.5x14	-	-	80-T15		
A25R SDQCR/L 11	●	●	25	23	200	17	≥32						
A32S SDQCR/L 11	●	●	32	30	250	22	≥40						

R: Sağ/Right L: Sol/Left ● Stokta/In Stock ○ Stokta Yok/Non Stock Item

Sipariş Örneği/Ordering Example : 1 ad./pcs. S10K SDPCR 07

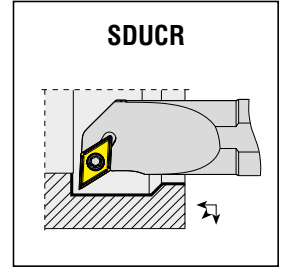
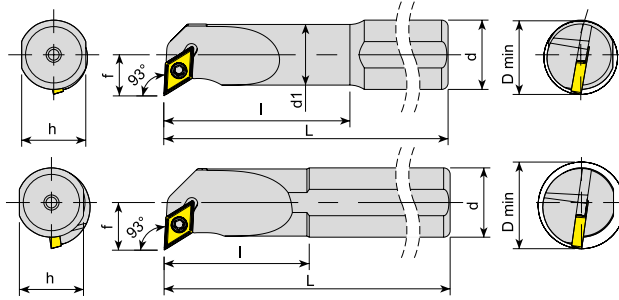

Takım Kodu Ordering Code	Stok Stock		Takım Ölçüleri (mm) Dimension (mm)						Kesici Uç Insert	Yedek Parçaları Spare Parts				
	R	L	d	d1	h	l	L	f		D min	Sıkma Vidası Screw	Altık Shim	Altık Vidası Shim Screw	Tork Anahtar Torx Key
S0810K SDUCR/L 07	●	●	10	8	09	30	125	08	≥13	DC.T 0702..	4008-M2.5x6	-	-	80-T08
S10K SDUCR/L 07	●	●	10	10	09	25	125	08	≥13					
S12K SDUCR/L 07	●	●	12	12	11	25	125	09	≥16					
S1216P SDUCR/L 07	●	○	16	11.5	14.8	37	170	09	≥16					
S1416P SDUCR/L 07	●	●	16	14	14.8	45	170	9.5	≥17					
S16P SDUCR/L 07	●	●	16	16	14.8	35	170	11	≥20					
S20R SDUCR/L 07	●	●	20	20	18.3	40	200	13	≥25					
S1416P SDUCR/L 11	●	○	16	14	14.8	45	170	11	≥18	DC.T 11T3..	4015-M3.5x9	-	-	80-T15
S16P SDUCR/L 11	●	●	16	16	14.8	35	170	11	≥20					
S1620R SDUCR/L 11	●	○	20	16	18.3	50	200	11	≥20					
S20R SDUCR/L 11	●	●	20	20	18.3	40	200	13	≥25					
S25S SDUCR/L 11	●	●	25	25	23	50	250	17	≥32					
S32T SDUCR/L 11	●	●	32	32	30	60	300	22	≥40					
S40U SDUCR/L 11	●	●	40	40	37.5	70	350	27	≥50					
S50V SDUCR/L 11	●	○	50	50	47	80	400	35	≥63					
A0810H SDUCR/L 07	●	○	10	8	09	30	100	08	≥13	DC.T 0702..	4008-M2.5x6	-	-	80-T08
A10H SDUCR/L 07	●	●	10	10	09	25	100	08	≥13					
A12H SDUCR/L 07	●	●	12	12	11	25	100	09	≥16					
A16M SDUCR/L 07	●	●	16	16	14.8	35	150	11	≥20					
A20P SDUCR/L 07	●	●	20	20	18.3	40	170	13	≥25					
A16M SDUCR/L 11	●	●	16	16	14.8	35	150	11	≥20					
A20P SDUCR/L 11	●	●	20	20	18.3	40	170	13	≥25					
A25R SDUCR/L 11	●	●	25	25	23	50	200	17	≥32	DC.T 11T3..	4015-M3.5x9 4015-M3.5x11 4015-M3.5x12 4015-M3.5x14	-	-	80-T15
A32S SDUCR/L 11	●	●	32	32	30	60	250	22	≥40					

R: Sağ/Right L: Sol/Left ● Stokta/In Stock ○ Stokta Yok/Non Stock Item

Sipariş Örneği/Ordering Example : 1 ad./pcs. S0810K SDUCR 07





93°

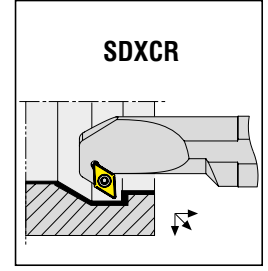
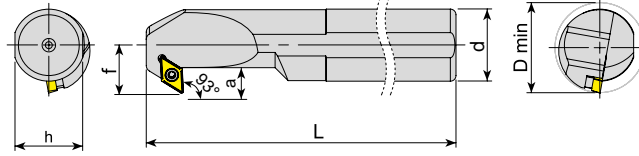

SDXCR

Takım Kodu Ordering Code	Stok Stock		Takım Ölçüleri (mm) Dimension (mm)						Kesici Uç Insert	Yedek Parçaları Spare Parts				
	R	L	d	h	L	f	a	D min		Sıkma Vidası Screw	Altlık Shim	Altlık Vidası Shim Screw	Tork Anahtar Torx Key	
S12K SDXCR/L 07	●	●	12	11	125	09	4.5	≥16	DC.T 0702..			-	-	80-T08
S16P SDXCR/L 07	●	●	16	14.8	170	11	6.5	≥20						
S20R SDXCR/L 07	○	○	20	18.3	200	13	6.5	≥25						
S16P SDXCR/L 11	○	○	16	14.8	170	11	7.5	≥20	DC.T 11T3..			-	-	80-T15
S20R SDXCR/L 11	●	●	20	18.3	200	14	7.5	≥25						
S25S SDXCR/L 11	●	●	25	23	250	17	9	≥32						
S32T SDXCR/L 11	●	●	32	30	300	22	12.5	≥40						
S40U SDXCR/L 11	●	●	40	37.5	350	27	14.5	≥50	4015-M3.5x14	AADN-2-0001	AAV-08-M3.5x8	AAV-06-M3.5x11		

Not: "a" ölçüleri R0.4'e göre verilmiştir.

Note: Dimensions of "a" are given according to R.04.

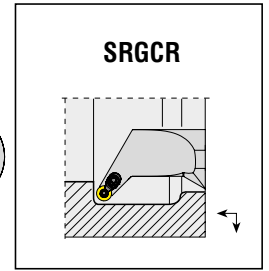
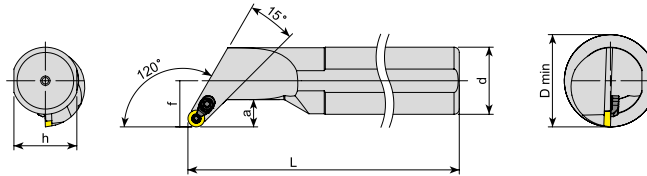

SRGCR

Takım Kodu Ordering Code	Stok Stock		Takım Ölçüleri (mm) Dimension (mm)						Kesici Uç Insert	Yedek Parçaları Spare Parts					
	R	L	d	h	L	f	a	D min		Sıkma Vidası Screw	Altlık Shim	Altlık Vidası Shim Screw	Baskı Pabucu Shim Screw	Pabuç Vidası Shim Screw	Anahtar Allen Key
S16P SRGCR/L 08	●	○	16	14.8	170	11	7	≥22	RCM. 0803..			-	-	-	80-T08
S20R SRGCR/L 08	●	○	20	18.3	200	13	7	≥26							
S25S SRGCR/L 08C	●	○	25	23	250	17	9.5	≥34							
S32T SRGCR/L 08C	●	○	32	30	300	22	13	≥44							
S40U SRGCR/L 08C	●	○	40	37.5	350	27	15	≥54							
									1008-M3x8			ACK-15	1015-M3.5x11		

R: Sağ/Right L: Sol/Left ● Stokta/In Stock ○ Stokta Yok/Non Stock Item

Sipariş Örneği/Ordering Example : 1 ad./pcs. S12K SDXCR 07

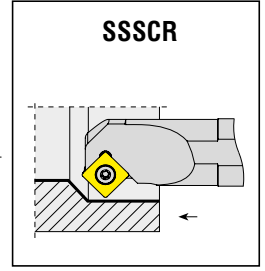
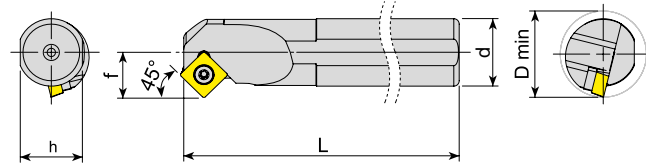

Takım Kodu Ordering Code	Stok Stock		Takım Ölçüleri (mm) Dimension (mm)					Kesici Uç Insert	Yedek Parçaları Spare Parts			
	R	L	d	h	L	f	D min		Sıkma Vidası Screw	Altık Shim	Altık Vidası Shim Screw	Tork Anahtar Torx Key
S16P SSSCR/L 09	●	●	16	14.8	170	11	≥20	SC.T 09T3..	4015-M3.5x9	-	-	80-T15
S20R SSSCR/L 09	●	●	20	18.3	200	13	≥25		4015-M3.5x11	-	-	
S25S SSSCR/L 09	●	●	25	23	250	17	≥32		4015-M3.5x12	AASN-2-0001	AAV-08-M3.5x8	
S25S SSSCR/L 12	●	○	25	23	250	17	≥32	SC.T 1204..	4020-M4.5x12	AASN-2-0004	AAV-10-M4.5x8	80-T20
S32T SSSCR/L 12	●	○	32	30	300	22	≥40		1020-M4.5x16		AAV-07-M4.5x13	
S40U SSSCR/L 12	●	○	40	37.5	350	27	≥50					

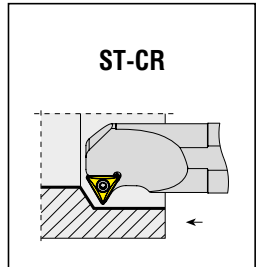
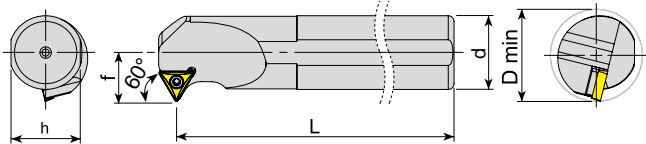

Takım Kodu Ordering Code	Stok Stock		Takım Ölçüleri (mm) Dimension (mm)					Kesici Uç Insert	Yedek Parçaları Spare Parts				
	R	L	d	h	L	f	D min		Sıkma Vidası Screw	Altık Shim	Altık Vidası Shim Screw	Tork Anahtar Torx Key	
S12K ST-CR/L 11	●	●	12	11	125	09	≥17	TC.T 1102..	4008-M2.5x6	-	-	80-T08	
S16P ST-CR/L 11	●	○	16	14.8	170	11	≥20		4015-M3.5x9	-	-		
S20R ST-CR/L 11	●	○	20	18.3	200	13	≥25		4015-M3.5x11	-	-		
S16P ST-CR/L 16	●	●	16	14.8	170	11	≥20	TC.T 16T3..	4015-M3.5x9	AATN-2-0001	AAV-08-M3.5x8	80-T15	
S20R ST-CR/L 16	●	●	20	18.3	200	13	≥25		4015-M3.5x11				
S25S ST-CR/L 16	●	●	25	23	250	17	≥32						
S32T ST-CR/L 16	●	●	32	30	300	22	≥40		4015-M3.5x14				AAV-06-M3.5x11
S40U ST-CR/L 16	●	●	40	37.5	350	27	≥50						

R: Sağ/Right L: Sol/Left ● Stokta/In Stock ○ Stokta Yok/Non Stock Item

Sipariş Örneği/Ordering Example : 1 ad./pcs. S16P SSSCR 09

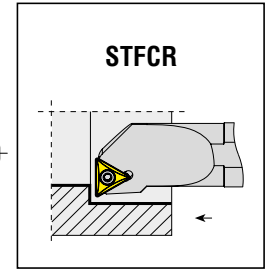
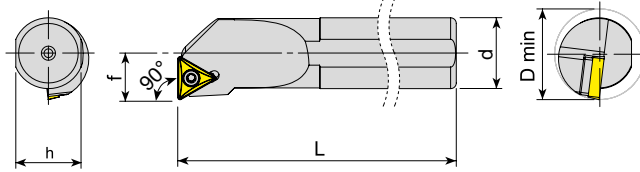

Takım Kodu Ordering Code	Stok Stock		Takım Ölçüleri (mm) Dimension (mm)					Kesici Uç Insert	Yedek Parçaları Spare Parts			
	R	L	d	h	L	f	D min		Sıkma Vidası Screw	Altılık Shim	Altılık Vidası Shim Screw	Tork Anahtar Torx Key
S0610F STFCR/L 06	●	●	10	09	80	4.5	≥08	TC.T 06T1..	3006-M2x4			80-T06
S08H STFCR/L 06	●	●	08	7.3	100	06	≥11					
S10K STFCR/L 09	●	●	10	09	125	07	≥13	TC.T 0902..	3007-M2.2x5	-	-	80-T07
S12K STFCR/L 09	●	●	12	11	125	09	≥17					
S12K STFCR/L 11	●	●	12	11	125	09	≥17	TC.T 1102..	4008-M2.5x6			80-T08
S16P STFCR/L 11	●	●	16	14.8	170	11	≥20					
S20R STFCR/L 11	●	●	20	18.3	200	13	≥25	TC.T 16T3..	4015-M3.5x9 4015-M3.5x11	-	-	80-T15
S16P STFCR/L 16	●	●	16	14.8	170	11	≥20					
S20R STFCR/L 16	●	●	20	18.3	200	13	≥25					
S25S STFCR/L 16	●	●	25	23	250	17	≥32					
S32T STFCR/L 16	●	●	32	30	300	22	≥40	4015-M3.5x14	AATN-2-0001	AAV-08-M3.5x8 AAV-06-M3.5x11		
S40U STFCR/L 16	○	○	40	37.5	350	27	≥50					

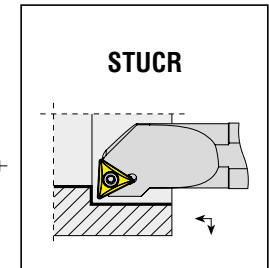
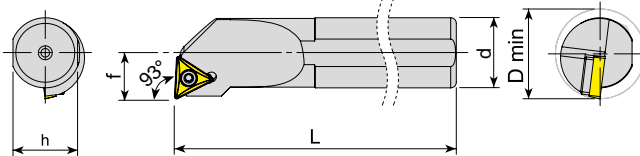





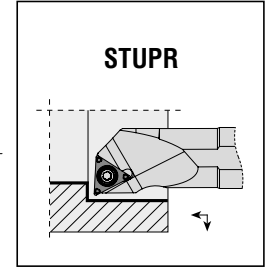
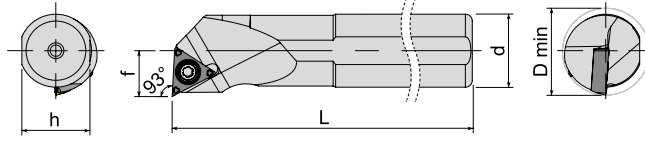

Takım Kodu Ordering Code	Stok Stock		Takım Ölçüleri (mm) Dimension (mm)					Kesici Uç Insert	Yedek Parçaları Spare Parts			
	R	L	d	h	L	f	D min		Sıkma Vidası Screw	Altılık Shim	Altılık Vidası Shim Screw	Tork Anahtar Torx Key
S10K STUCR/L 09	●	●	10	09	125	07	≥13	TC.T 0902..	3007-M2.2x5			80-T07
S12K STUCR/L 09	●	●	12	11	125	09	≥16					
S12K STUCR/L 11	●	●	12	11	125	09	≥17	TC.T 1102..	4008-M2.5x6	-	-	80-T08
S16P STUCR/L 11	●	●	16	14.8	170	11	≥20					
S20R STUCR/L 11	●	●	20	18.3	200	13	≥25	TC.T 16T3..	4015-M3.5x9 4015-M3.5x11	-	-	80-T15
S16P STUCR/L 16	●	●	16	14.8	170	11	≥20					
S20R STUCR/L 16	●	●	20	18.3	200	13	≥25					
S25S STUCR/L 16	●	●	25	23	250	17	≥32					
S32T STUCR/L 16	●	●	32	30	300	22	≥40	4015-M3.5x14	AATN-2-0001	AAV-08-M3.5x8 AAV-06-M3.5x11		
S40U STUCR/L 16	●	●	40	37.5	350	27	≥50					





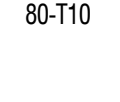

R: Sağ/Right L: Sol/Left ● Stokta/In Stock ○ Stokta Yok/Non Stock Item

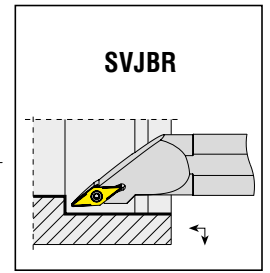
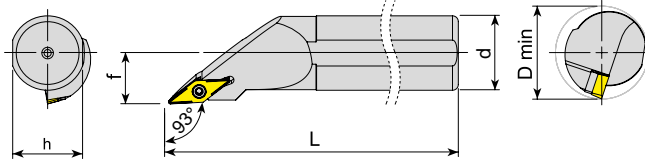
Sipariş Örneği/Ordering Example : 1 ad./pcs. S0610F STFCR 06



Takım Kodu Ordering Code	Stok Stock		Takım Ölçüleri (mm) Dimension (mm)					Kesici Uç Insert	Yedek Parçaları Spare Parts			
	R	L	d	h	L	f	D min		Sıkma Vidası Screw	Altık Shim	Altık Vidası Shim Screw	Tork Anahtar Torx Key
S08H STUPR/L 0802	●	○	08	7.3	100	05	≥10	 TP.. 0802..	 3006-M2x4			 80-T06
S10K STUPR/L 1103	●	○	10	09	125	06	≥12					
S12K STUPR/L 1103	●	○	12	11	125	09	≥16					
S12M STUPR/L 1103	●	○	12	11	150	08	≥16					
S16P STUPR/L 1103	●	○	16	14.8	170	10	≥20					
S16R STUPR/L 1103	●	○	16	14.8	200	10	≥20					
							TP.. 1103..	 4010-M3x6  4010-M3x8	-	-	 80-T10	



Takım Kodu Ordering Code	Stok Stock		Takım Ölçüleri (mm) Dimension (mm)					Kesici Uç Insert	Yedek Parçaları Spare Parts			
	R	L	d	h	L	f	D min		Sıkma Vidası Screw	Altık Shim	Altık Vidası Shim Screw	Tork Anahtar Torx Key
S25S SVJBR/L 16	●	●	25	23	250	17	≥32	 VBM. 1604..	 4015-M3.5x12  4015-M3.5x14		 AAV-08-M3.5x8  AAV-06-M3.5x11	 80-T15
S32T SVJBR/L 16	●	●	32	30	300	22	≥40					
S40U SVJBR/L 16	●	●	40	37.5	350	27	≥50					

R: Sağ/Right L: Sol/Left ● Stokta/In Stock ○ Stokta Yok/Non Stock Item

Sipariş Örneği/Ordering Example : 1 ad./pcs. S08H STUPR 0802

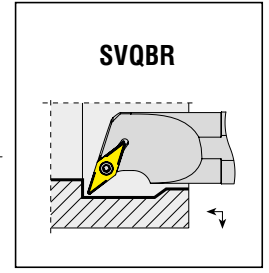
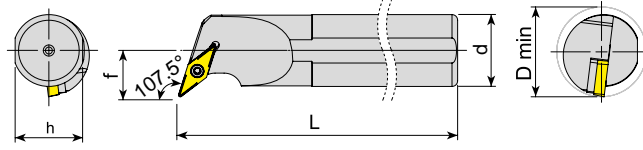

Takım Kodu Ordering Code	Stok Stock		Takım Ölçüleri (mm) Dimension (mm)				Kesici Uç Insert	Yedek Parçaları Spare Parts				
	R	L	d	h	L	f		D min	Sıkma Vidası Screw	Altılık Shim	Altılık Vidası Shim Screw	Tork Anahtar Torx Key
S16P SVQBR/L 11	●	●	16	14.8	170	11	≥20	VBM. 1103..	4008-M2.5x6	-	-	80-T08
S20R SVQBR/L 11	●	●	20	18.3	200	13	≥25					
S25S SVQBR/L 16	●	●	25	23	250	17	≥32	VBM. 1604..	4015-M3.5x14	AAVN-2-0002	AAV-08-M3.5x8	80-T15
S32T SVQBR/L 16	●	●	32	30	300	22	≥40				AAV-06-M3.5x11	
S40U SVQBR/L 16	●	●	40	37.5	350	27	≥50					

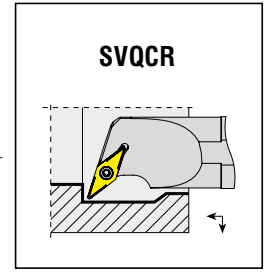
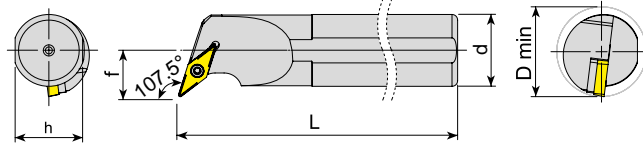

Takım Kodu Ordering Code	Stok Stock		Takım Ölçüleri (mm) Dimension (mm)				Kesici Uç Insert	Yedek Parçaları Spare Parts				
	R	L	d	h	L	f		D min	Sıkma Vidası Screw	Altılık Shim	Altılık Vidası Shim Screw	Tork Anahtar Torx Key
S16P SVQCR/L 11	●	●	16	14.8	170	11	≥20	VC.T 1103..	4008-M2.5x6	-	-	80-T08
S20R SVQCR/L 11	●	●	20	18.3	200	13	≥25					
S25S SVQCR/L 16	●	●	25	23	250	17	≥32	VC.T 1604..	4015-M3.5x14	AAVN-2-0002	AAV-08-M3.5x8	80-T15
S32T SVQCR/L 16	●	●	32	30	300	22	≥40				AAV-06-M3.5x11	
S40U SVQCR/L 16	●	●	40	37.5	350	27	≥50					

R: Sağ/Right L: Sol/Left ● Stokta/In Stock ○ Stokta Yok/Non Stock Item

Sipariş Örneği/Ordering Example : 1 ad./pcs. S16P SVQBR 11

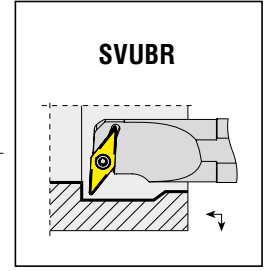
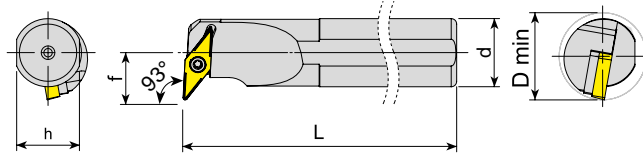

Takım Kodu Ordering Code	Stok Stock		Takım Ölçüleri (mm) Dimension (mm)					Kesici Uç Insert	Yedek Parçaları Spare Parts			
	R	L	d	h	L	f	D min		Sıkma Vidası Screw	Altık Shim	Altık Vidası Shim Screw	Tork Anahtar Torx Key
S16P SVUBR/L 11	●	●	16	14.8	170	12.5	≥20	VBM. 1103..	4008-M2.5x6	-	-	80-T08
S20R SVUBR/L 11	●	●	20	18.3	200	13	≥25					
S25S SVUBR/L 16	●	●	25	23	250	19	≥32	VBM. 1604..	4015-M3.5x14	AAVN-2-0002	AAV-06-M3.5x11	80-T15
S32T SVUBR/L 16	●	●	32	30	300	22	≥40					
S40U SVUBR/L 16	●	●	40	37.5	350	27	≥50					

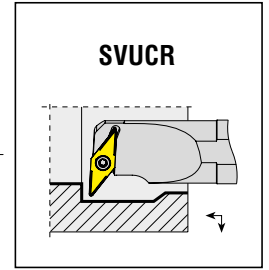
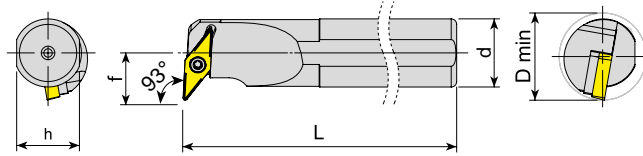

Takım Kodu Ordering Code	Stok Stock		Takım Ölçüleri (mm) Dimension (mm)					Kesici Uç Insert	Yedek Parçaları Spare Parts			
	R	L	d	h	L	f	D min		Sıkma Vidası Screw	Altık Shim	Altık Vidası Shim Screw	Tork Anahtar Torx Key
S16P SVUCR/L 11	●	●	16	14.8	170	12.5	≥20	VC.T 1103..	4008-M2.5x6	-	-	80-T08
S20R SVUCR/L 11	●	●	20	18.3	200	13	≥25					
S25S SVUCR/L 16	●	●	25	23	250	19	≥32	VC.T 1604..	4015-M3.5x14	AAVN-2-0002	AAV-06-M3.5x11	80-T15
S32T SVUCR/L 16	●	●	32	30	300	22	≥40					
S40U SVUCR/L 16	●	●	40	37.5	350	27	≥50					

R: Sağ/Right L: Sol/Left ● Stokta/In Stock ○ Stokta Yok/Non Stock Item

Sipariş Örneği/Ordering Example : 1 ad./pcs. S16P SVUBR 11

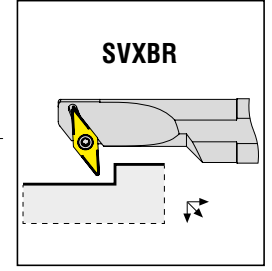
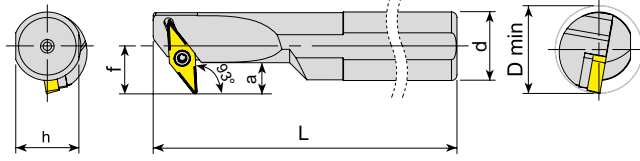

Takım Kodu Ordering Code	Stok Stock		Takım Ölçüleri (mm) Dimension (mm)					Kesici Uç Insert	Yedek Parçaları Spare Parts				
	R	L	d	h	L	f	a		D min	Sıkma Vidası Screw	Altlık Shim	Altlık Vidası Shim Screw	Tork Anahtar Torx Key
S16P SVXBR/L 1102	●	○	16	14.8	170	12.5	7.2	≥20	VBM. 1102..	4008-M2.5x6	-	-	80-T08
S20R SVXBR/L 1102	●	○	20	18.3	200	13	5.7	≥25					
S16P SVXBR/L 11	●	●	16	14.8	170	12.5	7.2	≥20	VBM. 1103..	-	-	80-T08	
S20R SVXBR/L 11	●	●	20	18.3	200	13	5.7	≥25					
S25S SVXBR/L 16	●	●	25	23	250	19	10.2	≥32	VBM. 1604..	4015-M3.5x14	AAVN-2-0002	AAV-06-M3.5x11	80-T15
S32T SVXBR/L 16	●	●	32	30	300	22	11.7	≥40					
S40U SVXBR/L 16	●	●	40	37.5	350	27	14.3	≥50					

Not: "a" ölçüleri R0.4'e göre verilmiştir.

Note: Dimensions of "a" are given according to R.04.

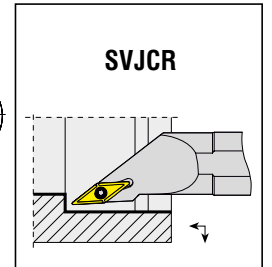
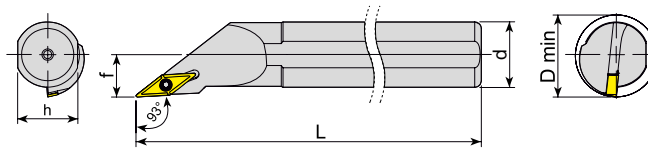

Takım Kodu Ordering Code	Stok Stock		Takım Ölçüleri (mm) Dimension (mm)					Kesici Uç Insert	Yedek Parçaları Spare Parts			
	R	L	d	h	L	f	D min		Sıkma Vidası Screw	Altlık Shim	Altlık Vidası Shim Screw	Tork Anahtar Torx Key
S12K SVJCR/L 11	●	●	12	11	125	7	13	VC.T 1103..	4008-M2.5x6	-	-	80-T08
S16P SVJCR/L 11	●	●	16	14.8	170	11	20					
S20R SVJCR/L 11	●	●	20	18.3	200	13	25					

R: Sağ/Right L: Sol/Left ● Stokta/In Stock ○ Stokta Yok/Non Stock Item

Sipariş Örneği/Ordering Example : 1 ad./pcs. S16P SVXBR 1102

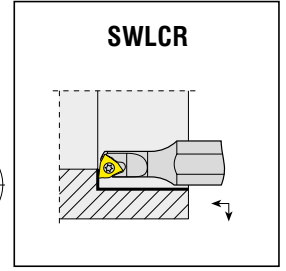
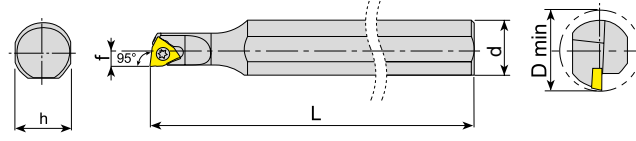

Takım Kodu Ordering Code	Stok Stock	Takım Ölçüleri (mm) Dimension (mm)					Kesici Uç Insert	Yedek Parçaları Spare Parts			
		d	h	L	f	D min		Sıkma Vidası Screw	Altık Shim	Altık Vidası Shim Screw	Tork Anahtar Torx Key
S0608H SWLCR 03	●	08	7.3	100	04	≥08	WC.. 0302..	4008-M2.5x4	-	-	80-T08
S0810K SWLCR 03	●	10	09	125	06	≥10					

R: Sağ/Right L: Sol/Left ● Stokta/In Stock ○ Stokta Yok/Non Stock Item

Sipariş Örneği/Ordering Example : 1 ad./pcs. S16P SVXBR 11

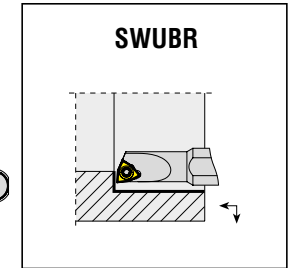
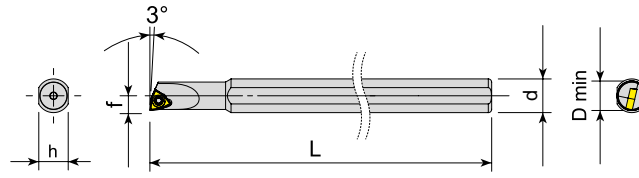

Takım Kodu Ordering Code	Stok Stock	Takım Ölçüleri (mm) Dimension (mm)					Kesici Uç Insert	Yedek Parçaları Spare Parts			
		d	h	L	f	D min		Sıkma Vidası Screw	Altık Shim	Altık Vidası Shim Screw	Tork Anahtar Torx Key
S08H SWUBR 06-5.5	●	08	7.3	100	2.75	≥5.5	WBGT 060102-L	3006-M2x3.6	-	-	80-T06
S08H SWUBR 06-7	●	08	7.3	100	3.5	≥7		3006-M2x4			

R: Sağ/Right L: Sol/Left ● Stokta/In Stock ○ Stokta Yok/Non Stock Item
KYCR Ucuna Uygunudur. / Compatible with KYCR Insert.

Sipariş Örneği/Ordering Example : 1 ad./pcs. S0608H SWLCR 03

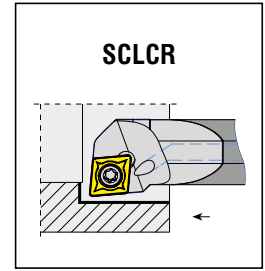
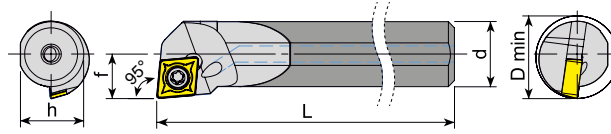

Takım Kodu Ordering Code	Stok Stock		Takım Ölçüleri (mm) Dimension (mm)				Kesici Uç Insert	Yedek Parçaları Spare Parts				
	R	L	d	h	L	f		D min	Sıkma Vidası Screw	Altık Shim	Altık Vidası Shim Screw	Anahtar Allen Key
E08K SCLCR/L 06	●	○	8	7.5	125	6	≥11	CC.T 0602..	4008-M2.5x6	-	-	80-T08
E10M SCLCR/L 06	●	○	10	9.5	150	7	≥13					
E12Q SCLCR/L 06	●	○	12	11	180	9	≥16	CC.T 09T3..	4015-M3.5x9	-	-	80-T15
E16R SCLCR/L 09	●	○	16	15	200	11	≥20					

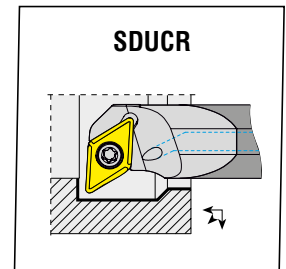
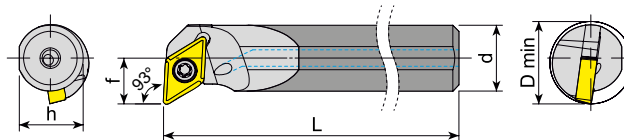

Takım Kodu Ordering Code	Stok Stock		Takım Ölçüleri (mm) Dimension (mm)				Kesici Uç Insert	Yedek Parçaları Spare Parts				
	R	L	d	h	L	f		D min	Sıkma Vidası Screw	Altık Shim	Altık Vidası Shim Screw	Anahtar Allen Key
E10M SDUCR/L 07	●	○	10	9.5	150	8	≥13	DC.T 0702..	4008-M2.5x6	-	-	80-T08
E12Q SDUCR/L 07	●	○	12	11	180	9	≥16					
E16R SDUCR/L 11	●	○	16	15	200	11	≥20	DC.T 11T3..	4015-M3.5x9	-	-	80-T15

R: Sağ/Right L: Sol/Left ● Stokta/In Stock ○ Stokta Yok/Non Stock Item

Sipariş Örneği/Ordering Example : 1 ad./pcs. E08K SCLCR 06

SET-A/SCLCR/L

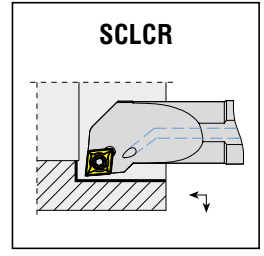
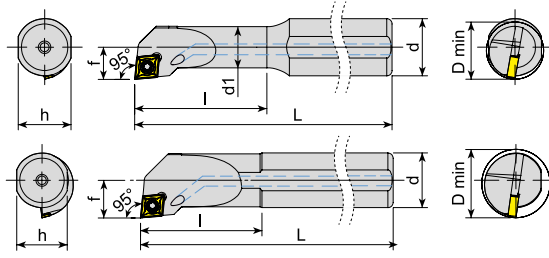

Takım Kodu
Ordering Code

Stok
Stock

Takım Ölçüleri (mm)
Dimension (mm)

Kesici Uç
Insert

Yedek Parçaları
Spare Parts

Sıkma Vidası
Screw

Altık
Shim

Altık Vidası
Shim Screw

Tork Anahtar
Torx Key

R L

d

d1

h

l

L

f

D min

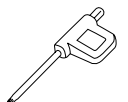
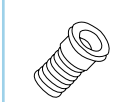
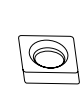

Takım Kodu Ordering Code	R	L	d	d1	h	l	L	f	D min	Kesici Uç Insert	Sıkma Vidası Screw	Altık Shim	Altık Vidası Shim Screw	Tork Anahtar Torx Key
A08H SCLCR/L 06	●	●	8	8	7.3	20	100	6	≥11	CC.T 0602..	4008-M2.5x6	-	-	80-T08
A10H SCLCR/L 06	●	●	10	10	9	25	100	7	≥13					
A12H SCLCR/L 06	●	●	12	12	11	25	100	9	≥16					
A16M SCLCR/L 09	●	●	16	16	14.8	35	150	11	≥20	CC.T 09T3..	4015-M3.5x9			80-T15

SET-E/SCLCR/L

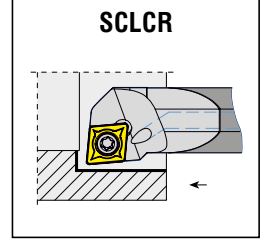
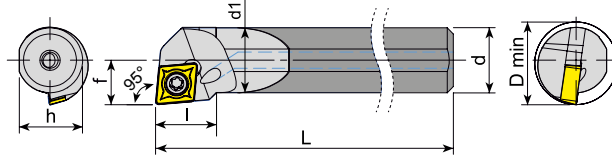

Takım Kodu
Ordering Code

Stok
Stock

Takım Ölçüleri (mm)
Dimension (mm)

Kesici Uç
Insert

Yedek Parçaları
Spare Parts

Sıkma Vidası
Screw

Altık
Shim

Altık Vidası
Shim Screw

Tork Anahtar
Torx Key

R L

d

d1

h

l

L

f

D min

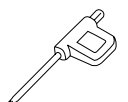
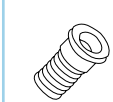
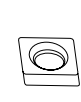
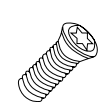

Takım Kodu Ordering Code	R	L	d	d1	h	l	L	f	D min	Kesici Uç Insert	Sıkma Vidası Screw	Altık Shim	Altık Vidası Shim Screw	Tork Anahtar Torx Key
E08K SCLCR/L 06	●	○	8	8	7.5	10	125	6	≥11	CC.T 0602..	4008-M2.5x6	-	-	80-T08
E10M SCLCR/L 06	●	○	10	10	9.5	10	150	7	≥13					
E12Q SCLCR/L 06	●	○	12	12	11	12	180	9	≥16					
E16R SCLCR/L 09	●	○	16	16	15	15	200	11	≥20	CC.T 09T3..	4015-M3.5x9			80-T15

SET-S/SCLCR/L

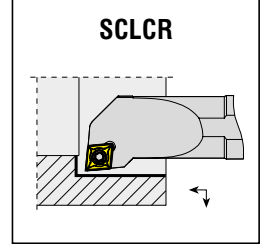
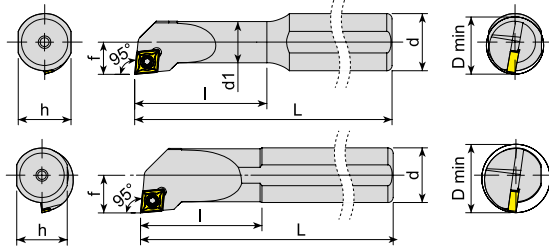

Takım Kodu
Ordering Code

Stok
Stock

Takım Ölçüleri (mm)
Dimension (mm)

Kesici Uç
Insert

Yedek Parçaları
Spare Parts

Sıkma Vidası
Screw

Altık
Shim

Altık Vidası
Shim Screw

Tork Anahtar
Torx Key

R L

d

d1

h

l

L

f

D min

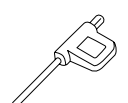
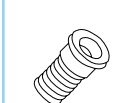
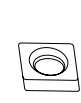
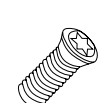

Takım Kodu Ordering Code	R	L	d	d1	h	l	L	f	D min	Kesici Uç Insert	Sıkma Vidası Screw	Altık Shim	Altık Vidası Shim Screw	Tork Anahtar Torx Key
S08H SCLCR/L 06	●	●	8	8	7.3	20	100	6	≥11	CC.T 0602..	4008-M2.5x6	-	-	80-T08
S10K SCLCR/L 06	●	●	10	10	9	25	125	7	≥13					
S12K SCLCR/L 06	●	●	12	12	11	25	125	9	≥16					
S16P SCLCR/L 09	●	●	16	16	14.8	35	170	11	≥20	CC.T 09T3..	4015-M3.5x9			80-T15

R: Sağ/Right L: Sol/Left ● Stokta/In Stock ○ Stokta Yok/Non Stock Item

Sipariş Örneği/Ordering Example : 1 ad./pcs. SET-A/SCLCR



www.akk.com.tr

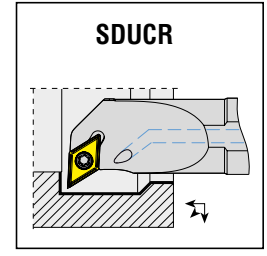
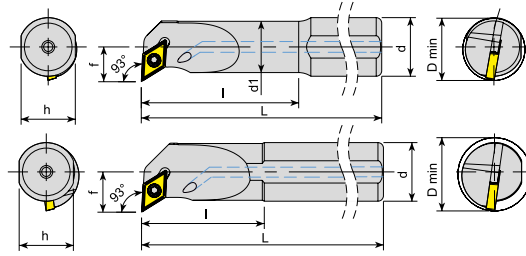

Takım Kodu Ordering Code	Stok Stock	Takım Ölçüleri (mm) Dimension (mm)								Kesici Uç Insert	Yedek Parçaları Spare Parts						
		R	L	d	d1	h	l	L	f		D min	Sıkma Vidası Screw	Altılık Shim	Altılık Vidası Shim Screw	Tork Anahtar Torx Key		
A10H SDUCR/L 07	●●	10	10	09	25	100	08	≥13	DC.T 0702..		4008-M2.5x6						
A12H SDUCR/L 07	●●	12	12	11	25	100	09	≥16							-	-	80-T08
A16M SDUCR/L 11	●●	16	16	14.8	35	150	11	≥20							DC.T 11T3..	4015-M3.5x9	-

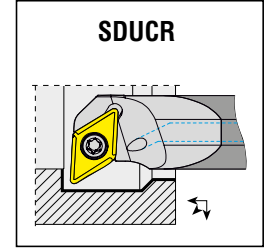
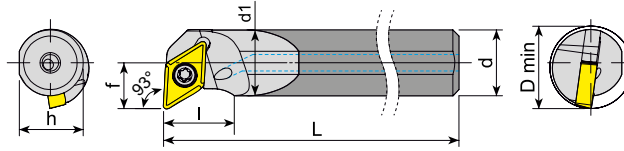

Takım Kodu Ordering Code	Stok Stock	Takım Ölçüleri (mm) Dimension (mm)								Kesici Uç Insert	Yedek Parçaları Spare Parts						
		R	L	d	d1	h	l	L	f		D min	Sıkma Vidası Screw	Altılık Shim	Altılık Vidası Shim Screw	Tork Anahtar Torx Key		
E10M SDUCR/L 07	●○	10	10	9.5	09	150	8	≥13	DC.T 0702..		4008-M2.5x6						
E12Q SDUCR/L 07	●○	12	12	11	10	180	9	≥16							-	-	80-T08
E16R SDUCR/L 11	●○	16	16	15	12	200	11	≥20							DC.T 11T3..	4015-M3.5x9	-

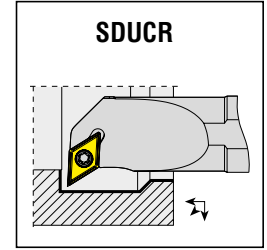
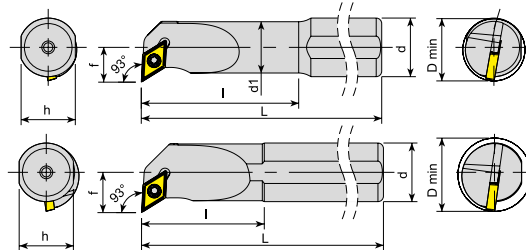

Takım Kodu Ordering Code	Stok Stock	Takım Ölçüleri (mm) Dimension (mm)								Kesici Uç Insert	Yedek Parçaları Spare Parts						
		R	L	d	d1	h	l	L	f		D min	Sıkma Vidası Screw	Altılık Shim	Altılık Vidası Shim Screw	Tork Anahtar Torx Key		
S10K SDUCR/L 07	●●	10	10	9	25	125	8	≥13	DC.T 0702..		4008-M2.5x6						
S12K SDUCR/L 07	●●	12	12	11	25	125	9	≥16							-	-	80-T08
S16P SDUCR/L 11	●●	16	16	14.8	35	170	11	≥20							DC.T 11T3..	4015-M3.5x9	-

R: Sağ/Right L: Sol/Left ● Stokta/In Stock ○ Stokta Yok/Non Stock Item

Sipariş Örneği/Ordering Example : 1 ad./pcs. SET-A/SDUCR