

*konusulan*  
*the spoken kalite...*  
*quality...*

# FREZELEME TAKIMLARI

## MILLING TOOLS



AKKO  
**A**

1

**EM**

2

**90**

3

**L**

4

**- A**

5

**P**

6

**10**

7

**D12**

8

**- W16**

9

**- L100**

10

**- Z01**

11

**- H**

12

## 2 Kesiş Stili / Cutter Style

FM: Yüzey Frezeleme Takımları - Face Milling Tools  
EM: Alın ve Yüzey Parmak Frezeleri - End Face Milling Tools  
CM: Pah Kırma Parmak Frezeleri - Chamfering End Milling Tools  
HM: Helis Parmak Frezeleri - Helix End Milling Tools  
TSM: T Kanal Frezeleri - T Slot Milling Tools  
HFM: Yüksek İlerleme Frezeleme Takımları - High Feed Milling Tools  
PMR: Küresel Uçlu Parmak Frezeleri - Ball Nose End Milling Tools  
SDM: Disk Frezeler / Slot Disc Milling  
CBM: Silindirik Alyan Başlı Vida Havşalarını Açma Frezeleri  
Countersink Milling Tool for Cylindrical Allen Head Screws

## 3 Freze Yanaşma Açısı / Lead Angle

90° - 75° - 60° - 45°  
20° - 15° - 11° - 5° - 0°

## 4 Freze Yanaşma Açısı / Lead Angle

L: Sol - Left  
C: Baskı Pabucu - Clamp  
S: Altık - Shim  
CL: Baskı Pabuçlu Sol Yön - Left Way with Clamp  
CS: Baskı Pabuçlu Altıklı - Clamp with Shim  
CSL: Baskı Pabuçlu Altıklı Sol Yön - Left Way Clamp with Shim

## 7 Kesme Kenar Uzunluğu / Cutting Edge Length

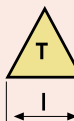
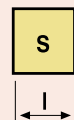
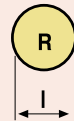
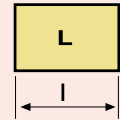
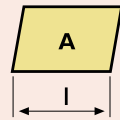

## 5 Uç Tipi / Insert Shape

<b>C</b>	<b>D</b>	<b>E</b>	<b>K</b>
<b>L</b>	<b>R</b>	<b>S</b>	<b>T</b>
<b>V</b>	<b>W</b>	<b>A</b>	<b>B</b>
<b>H</b>	<b>M</b>	<b>O</b>	<b>P</b>

## 6 Serbest Uç Açısı / Clearance angle of Insert

<b>A</b>	<b>B</b>	<b>C</b>
<b>D</b>	<b>E</b>	<b>F</b>
<b>G</b>	<b>N</b>	<b>P</b>

## 8 Takım Çapı / Tool Diameter

## 9 Montaj Formu ve Çapı / Assembly Form and Diameter

A, B, C, D;: ISO'ya göre montaj formu / Assembly form according to ISO  
C: Silindirik Şaft / Cylindrical Shank  
W: Weldon

## 10 Takım Boyu / Tool Length

## 11 Etkili Diş Adedi / Number of Effective Tooth

## 12 İçten Soğutmalı / With Coolant Hole

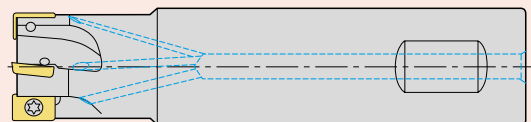

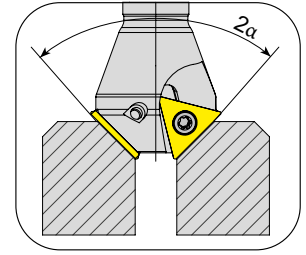
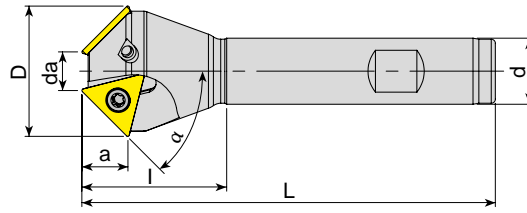

Takım Kodu Ordering Code	Stok Stock	Takım Ölçüleri (mm) Dimension (mm)							Kesici Uç Insert	Yedek Parçaları Spare Parts					
		α	da	D	d	L	l	Z		a	Sıkma Vidası Screw	Tork Anahtar Torx Key			
ACM10-TC16-D17X22-W16-L90-Z01	●	10°	17	22	16	90	30	1	15.2						
ACM15-TC16-D17X24-W16-L90-Z01	●	15°	17	24	16	90	30	1	14.9						
ACM15-TC16-D22X29-W16-L100-Z01	●	15°	22	29	16	100	30	1	14.9						
ACM15-TC16-D30X37-W20-L100-Z02	●	15°	30	37	20	100	35	2	14.9						
ACM15-TC16-D35X42-W20-L100-Z03	●	15°	35	42	20	100	38	3	14.9						
ACM15-TC16-D52X59-W25-L110-Z03	●	15°	52	59	25	110	40	3	14.9						
ACM17.5-TC16-D17X25-W16-L90-Z01	●	17.5°	17	25	16	90	30	1	14.7						
ACM18.5-TC16-D21.3X30-W20-L100-Z02	●	18.5°	21.3	30	20	100	30	2	13.5						
ACM20-TC16-D12X22-W16-L100-Z01	●	20°	12	22	16	100	30	1	14.4						
ACM20-TC16-D17X27-W16-L100-Z01	●	20°	17	27	16	100	30	1	14.4						
ACM20-TC16-D23X33-W20-L100-Z02	●	20°	23	33	20	100	30	2	14.4						
ACM20-TC16-D28X38-W20-L100-Z02	●	20°	28	38	20	100	35	2	14.4						
ACM20-TC16-D35X45-W20-L100-Z03	●	20°	35	45	20	100	40	3	14.4						
ACM20-TC16-D39X49-W20-L100-Z03	●	20°	39	49	20	100	40	3	14.4						
ACM20-TC16-D45X55-W25-L110-Z03	●	20°	45	55	25	110	40	3	14.4						
ACM20-TC16-D51X61-W25-L110-Z03	●	20°	51	61	25	110	40	3	14.4						
ACM22.5-TC16-D17X28-W16-L100-Z01	●	22.5°	17	28	16	100	30	1	14.2						
ACM25-TC16-D17X29-W16-L100-Z01	●	25°	17	29	16	100	30	1	13.9						
ACM30-TC16-D6X20-W16-L100-Z01	●	30°	6	20	16	100	30	1	13.3						
ACM30-TC16-D15X30-W16-L100-Z01	●	30°	15	30	16	100	30	1	13.3						
ACM30-TC16-D17.5X32.5-W20-L100-Z02	●	30°	17.5	32.5	20	100	30	2	13.3						
ACM30-TC16-D20X35-W16-L100-Z02	●	30°	20	35	16	100	35	2	13.3						
ACM30-TC16-D30X45-W20-L100-Z02	●	30°	30	45	20	100	40	2	13.3						
ACM30-TC16-D35X50-W20-L100-Z03	●	30°	35	50	20	100	40	3	13.3						
ACM30-TC16-D45X60-W25-L110-Z03	●	30°	45	60	25	110	40	3	13.3						
ACM45-TC09-D7X18-W16-L100-Z02	●	45°	7	18	16	100	25	2	5.9				TC.T 090204	3007-M2.2x5	80-T07
ACM45-TC11-D11X24-W16-L100-Z02	●	45°	11	24	16	100	25	2	6.9				TC.T 110204	3008-M2.5x6	80-T08
ACM45-TC16-D5X26-W16-L100-Z01	●	45°	5	26	16	100	30	1	10.8				TC.T 16T304	4015-M3.5x9	80-T15
ACM45-TC16-D10X31-W16-L100-Z02	●	45°	10	31	16	100	35	2	10.8						
ACM45-TC16-D10X31-W20-L100-Z02	●	45°	10	31	20	100	35	2	10.8						
ACM45-TC16-D18X39-W16-L100-Z02	●	45°	18	39	16	100	40	2	10.8						
ACM45-TC16-D18X39-W20-L100-Z02	●	45°	18	39	20	100	40	2	10.8						
ACM45-TC16-D20X41-W20-L100-Z02	●	45°	20	41	20	100	40	2	10.8						
ACM45-TC16-D30X51-W20-L100-Z02	●	45°	30	51	20	100	40	2	10.8						
ACM55-TC16-D16X40-W20-L100-Z03	●	55°	16	40	20	100	40	3	8.7						
ACM62-TC16-D14X40-W20-L100-Z03	●	62°	14	40	20	100	40	3	7.1						
ACM72-TC16-D14X42-W20-L100-Z03	●	72°	14	42	20	100	40	3	4.6						

R: Sağ/Right L: Sol/Left ● Stokta/In Stock ○ Stokta Yok/Non Stock Item  
ISO Ucuna Uygunudur. / Compatible with ISO Insert.

Sipariş Örneği/Ordering Example : 1 ad./pcs. ACM10-TC16-D17X22-W16-L90-Z01  
Kesme Hesabı : S 271 / Cutting Calculation : P 271

> S-SİSTEM PAH FREZELER  
S-SYSTEM CHAMFERING END MILLS

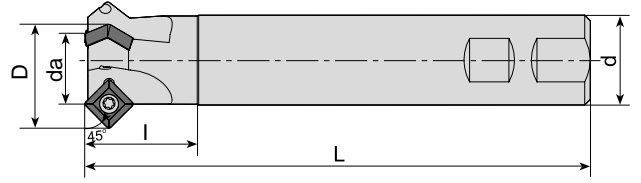

Takım Kodu Ordering Code	Stok Stock	Takım Ölçüleri (mm) Dimension (mm)								Kesici Uç Insert	Yedek Parçaları Spare Parts	
		$\alpha$	da	D	d	L	l	Z	a		Sıkma Vidası Screw	Tork Anahtar Torx Key
ACM45-SP1104-D12x26-W20-L150-Z01	●	45°	12	26	20	150	30	1	-	SPGT 110408	1515-M4x11	80-T15
ACM45-SP1104-D25x39-W25-L150-Z02	●	45°	25	39	25	150	35	2	-			
ACM45-SP1104-D32x46-W32-L150-Z03	●	45°	32	46	32	150	40	3	-			

ZCC Ucuna Uygundur. / Compatible with ZCC Insert.

> HELİS PAH FREZELEME TAKIMLARI  
HELIX CHAMFER MILLING TOOLS

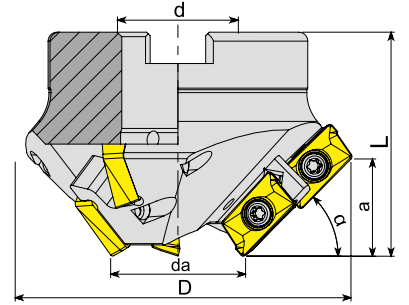

Takım Kodu Ordering Code	Stok Stock	Takım Ölçüleri (mm) Dimension (mm)								Kesici Uç Insert	Yedek Parçaları Spare Parts	
		Z		$\alpha$	da	D	d	a	L		Sıkma Vidası Screw	Tork Anahtar Torx Key
		Toplam Total	Etkili Effective									
AHM15-AP16-D35x93-A27-Z0306-H	●	6	3	15	35	93	27	8	50	AP.. 1604..	4015-M4x11	80-T15
AHM30-AP16-D35x87-A27-Z0306-H	●	6	3	30	35	87	27	15	50			
AHM45-AP16-D35x77-A27-Z0306-H	●	6	3	45	35	77	27	21.5	50			
AHM60-AP16-D35x65-A22-Z0306-H	●	6	3	60	35	65	22	26.5	50			
AHM75-AP16-D35x50-A22-Z0306-H	●	6	3	75	35	50	22	29.5	50			

R: Sağ/Right L: Sol/Left ● Stokta/In Stock ○ Stokta Yok/Non Stock Item  
ISO Ucuna Uygundur. / Compatible with ISO Insert.

Sipariş Örneği/Ordering Example : 1 ad./pcs. ACM45-SP1104-D12x26-W20-L150-Z01  
Kesme Hesabı : S 271 / Cutting Calculation : P 271

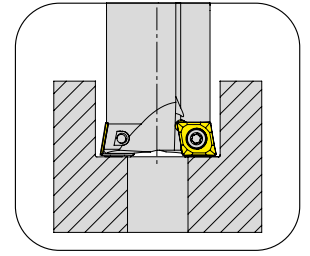
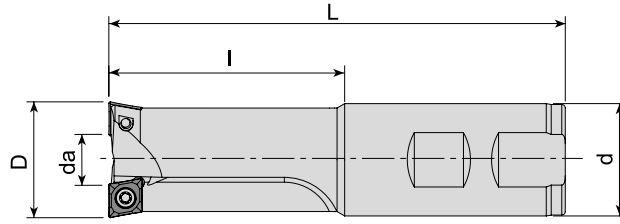

Takım Kodu Ordering Code	Stok Stock	Takım Ölçüleri (mm) Dimension (mm)						Kesici Uç Insert	Yedek Parçaları Spare Parts	
		da	D	d	l	L	Kullanılan Vidalar For Screws		Sıkma Vidası Screw	Tork Anahtar Torx Key
ACBM-CC06-D17X6-W16-L150-Z02	●	6	17	16	30	150	-	CC.. 060204	3008-M2.5x6	80-T08
ACBM-CC06-D18X7-W16-L100-Z02-H	●	7	18	16	32	100	M10			
ACBM-CC06-D18X7-W16-L160-Z02-H	●	7	18	16	32	160	M10			
ACBM-CC06-D20X9-W20-L100-Z02-H	●	9	20	20	40	100	M12			
ACBM-CC06-D20X9-W20-L160-Z02-H	●	9	20	20	38	160	M12	CC.. 09T304	4015-M3.5x9	80-T15
ACBM-CC09-D26X8.5-W25-L130-Z02-H	●	8.5	26	25	50	130	M16			
ACBM-CC09-D26X8.5-W25-L200-Z02	●	8.5	26	25	50	200	M16			
ACBM-CC09-D33X15.5-W32-L130-Z02-H	●	15.5	33	32	65	130	M20			
ACBM-CC09-D33X15.5-W32-L200-Z02	●	15.5	33	32	65	200	M20	SP.. 060204	3007-M2.2x5	80-T07
ACBM-SP06-D15X4-W16-L160-Z02-H	●	4	15	16	80	160	M8			

R: Sağ/Right L: Sol/Left ● Stokta/In Stock ○ Stokta Yok/Non Stock Item  
ISO Ucuna Uygundur. / Compatible with ISO Insert.

Sipariş Örneği/Ordering Example : 1 ad./pcs. ACBM-CC06-D17X6-W16-L150-Z02  
Kesme Hesabı : S 271 / Cutting Calculation : P 271



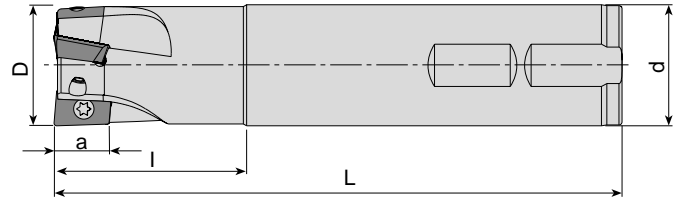

Takım Kodu Ordering Code	Stok Stock	Takım Ölçüleri (mm) Dimension (mm)						Kesici Uç Insert	Yedek Parçaları Spare Parts	
		D	Z	d	L	l	a		Sıkma Vidası Screw	Tork Anahtar Torx Key
AEM90-AD1505-D25-W25-L150-Z02	●	25	2	25	150	50	15	AD.. 1505..	1515-M4x9	80-T15
AEM90-AD1505-D30-W25-L150-Z03	●	30	3	25	150	40	15			
AEM90-AD1505-D32-W32-L150-Z03	●	32	3	32	150	50	15			

R: Sağ/Right L: Sol/Left ● Stokta/In Stock ○ Stokta Yok/Non Stock Item  
ISCR Ucuna Uygunudur. / Compatible with ISCR Insert.

Sipariş Örneği/Ordering Example : 1 ad./pcs. AEM90-AD1505-D25-W25-L150-Z02  
Kesme Hesabı : S 271 / Cutting Calculation : P 271



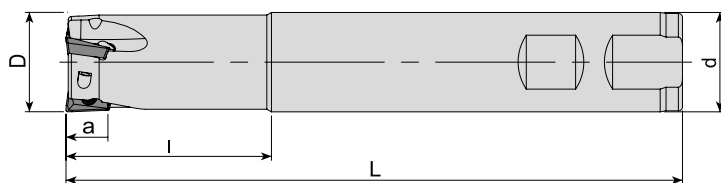

Takım Kodu Ordering Code	Stok Stock	Takım Ölçüleri (mm) Dimension (mm)						Kesici Uç Insert	Yedek Parçaları Spare Parts	
		D	Z	d	L	l	a		Sıkma Vidası Screw	Tork Anahtar Torx Key
AEM90-AD10T3-D16-W16-L100-Z02-H	●	16	2	16	100	30	10	ADMT 10T3..	3008-M2.5x6	80-T08
AEM90-AD10T3-D16-W16-L150-Z02	●	16	2	16	150	40	10			
AEM90-AD10T3-D16-C16-L200-Z02	●	16	2	16	200	50	10			
AEM90-AD10T3-D20-W20-L70-Z03	●	20	3	20	70	30	10			
AEM90-AD10T3-D20-W20-L100-Z03-H	●	20	3	20	100	30	10			
AEM90-AD10T3-D20-W20-L150-Z03	●	20	3	20	150	30	10			
AEM90-AD10T3-D20-C20-L150-Z03	●	20	3	20	150	40	10			
AEM90-AD10T3-D20-C20-L200-Z03	●	20	3	20	200	40	10			
AEM90-AD10T3-D25-W25-L100-Z03-H	●	25	3	25	100	30	10			
AEM90-AD10T3-D25-W25-L100-Z04-H	●	25	4	25	100	30	10			
AEM90-AD10T3-D25-W25-L150-Z03	●	25	3	25	150	50	10	ADMT 1204..	4010-M3x6	80-T10
AEM90-AD1204-D20-W20-L150-Z02	●	20	2	20	150	50	12			
AEM90-AD1204-D25-W25-L150-Z03	●	25	3	25	150	50	12			
AEM90-AD1204-D32-W32-L150-Z04	●	32	4	32	150	50	12	ADMT 1606..	4015-M4x9	80-T15
AEM90-AD1606-D25-W25-L150-Z02	●	25	2	25	150	50	15			
AEM90-AD1606-D32-W32-L150-Z03	●	32	3	32	150	50	15			

R: Sağ/Right L: Sol/Left ● Stokta/In Stock ○ Stokta Yok/Non Stock Item  
WLTR Ucuna Uygundur. / Compatible with WLTR Insert.

Sipariş Örneği/Ordering Example : 1 ad./pcs. AEM90-AD10T3-D16-W16-L100-Z02-H  
Kesme Hesabı : S 271 / Cutting Calculation : P 271



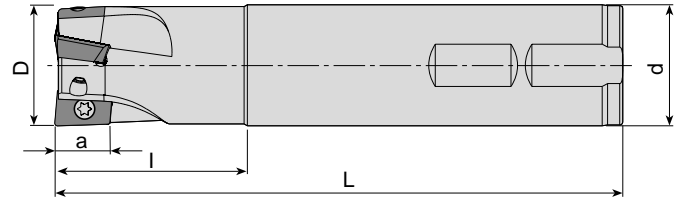

Takım Kodu Ordering Code	Stok Stock	Takım Ölçüleri (mm) Dimension (mm)						Kesici Uç Insert	Yedek Parçaları Spare Parts	
		D	Z	d	L	l	a		Sıkma Vidası Screw	Tork Anahtar Torx Key
AEM90-AD1003-D16-C16-L150-Z02	●	16	2	16	150	30	8	ADMT 1003..	3008-M2.5x6	80-T08
AEM90-AD1003-D17-C16-L150-Z02	●	17	2	16	150	25	8			
AEM90-AD1003-D20-C20-L200-Z03	●	20	3	20	200	50	8			
AEM90-AD1003-D21-C20-L200-Z03	●	21	3	20	200	25	8			
AEM90-AD1003-D25-C25-L200-Z03	●	25	3	25	200	50	8			
AEM90-AD1003-D26-C25-L150-Z03	●	26	3	25	150	30	8			
AEM90-AD1003-D26-C25-L200-Z03	●	26	3	25	200	30	8	ADKT 150508	4015-M4x9	80-T15
AEM90-AD1505D-D25-W25-L150-Z02	●	25	2	25	150	50	14.3		4015-M4x11	
AEM90-AD1505D-D32-W32-L150-Z03	●	32	3	32	150	50	14.3			

DJT Ucuna Uygun. / Compatible with DJT Insert.

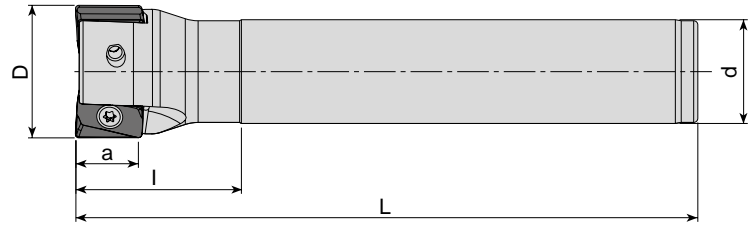

Takım Kodu Ordering Code	Stok Stock	Takım Ölçüleri (mm) Dimension (mm)						Kesici Uç Insert	Yedek Parçaları Spare Parts	
		D	Z	d	L	l	a		Sıkma Vidası Screw	Tork Anahtar Torx Key
AEM90-AN11-D22-W20-L150-Z02	●	22	2	20	150	30	11	ANGX 110508	4010-M3x8	80-T10
AEM90-AN11-D25-W25-L150-Z02	●	25	2	25	150	40	11			
AEM90-AN11-D25-C25-L200-Z02	●	25	2	25	200	40	11			
AEM90-AN11-D26-W25-L150-Z02	●	26	2	25	150	40	11			
AEM90-AN11-D28-W25-L150-Z02	●	28	2	25	150	25	11			
AEM90-AN11-D32-W32-L150-Z03	●	32	3	32	150	50	11			
AEM90-AN11-D32-C32-L200-Z03	●	32	3	32	200	50	11			
AEM90-AN11-D40-W32-L150-Z04	●	40	4	32	150	40	11			

R: Sağ/Right L: Sol/Left ● Stokta/In Stock ○ Stokta Yok/Non Stock Item  
ZCC Ucuna Uygun. / Compatible with ZCC Insert.

Sipariş Örneği/Ordering Example : 1 ad./pcs. AEM90-AD1003-D16-C16-L150-Z02  
Kesme Hesabı : S 271 / Cutting Calculation : P 271



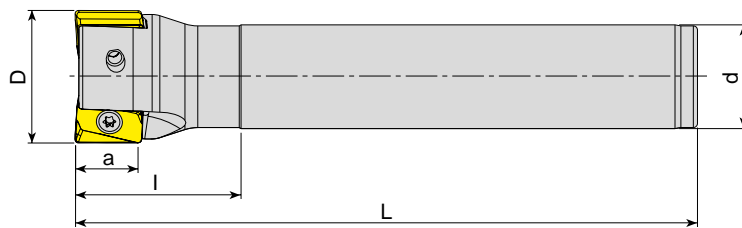

Takım Kodu Ordering Code	Stok Stock	Takım Ölçüleri (mm) Dimension (mm)						Kesici Uç Insert	Yedek Parçaları Spare Parts	
		D	Z	d	L	l	a		Sıkma Vidası Screw	Tork Anahtar Torx Key
AEM90-AN1607-D32-C25-L150-Z02	●	32	2	25	150	50	15	AN.X 1607	1515-M4x11	80-T15
AEM90-AN1607-D40-C32-L150-Z03	●	40	3	32	150	50	15			

TGTC Ucuna Uygundur. / Compatible with TGTC Insert.

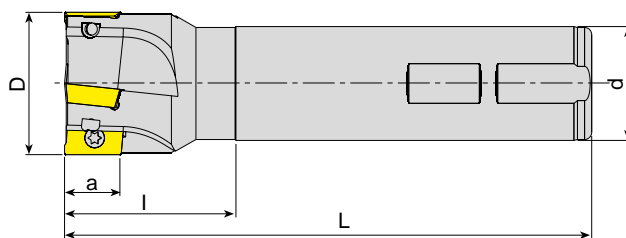





Takım Kodu Ordering Code	Stok Stock	Takım Ölçüleri (mm) Dimension (mm)						Kesici Uç Insert	Yedek Parçaları Spare Parts	
		D	Z	d	L	l	a		Sıkma Vidası Screw	Tork Anahtar Torx Key
AEM90-AP06-D10-C10-L120-Z02	●	10	2	10	120	20	5.6	APMT 0602.. KRILY UCUNA UYGUNDUR. FOR KRILY INSERT.	3006-M1.8x4	80-T06
AEM90-AP06-D12-C12-L120-Z02	●	12	2	12	120	20	5.6			
AEM90-AP0903-D16-C16-L150-Z02	●	16	2	16	150	30	9	APMT 0903.. KRILY UCUNA UYGUNDUR. FOR KRILY INSERT.	3008-M2.5x6	80-T08
AEM90-AP0903-D17-C16-L150-Z02	●	17	2	16	150	30	9			
AEM90-AP0903-D20-C20-L150-Z02	●	20	2	20	150	30	9	KRILY UCUNA UYGUNDUR. FOR KRILY INSERT.	3008-M2.5x6	80-T08
AEM90-AP0903-D21-C20-L150-Z02	●	21	2	20	150	30	9			
AEM90-AP0903-D25-C25-L150-Z03	●	25	3	25	150	30	9	APKT 09T3.. TGTC UCUNA UYGUNDUR. FOR TGTC INSERT.	3008-M2.5x6	80-T08
AEM90-AP09-D16-C16-L100-Z02-H	●	16	2	16	100	30	8.8			
AEM90-AP09-D16-C15-L150-Z02	●	16	2	15	150	25	8.8	APKT 09T3.. TGTC UCUNA UYGUNDUR. FOR TGTC INSERT.	3008-M2.5x6	80-T08
AEM90-AP09-D16-W16-L150-Z02-H	●	16	2	16	150	25	8.8			
AEM90-AP09-D16-C16-L200-Z02-H	●	16	2	16	200	100	8.8	TGTC UCUNA UYGUNDUR. FOR TGTC INSERT.	3008-M2.5x6	80-T08
AEM90-AP09-D17-C16-L150-Z02	●	17	2	16	150	25	8.8			
AEM90-AP09-D20-C20-L150-Z03-H	●	20	3	20	150	50	8.8	AP.. 1003.. ISO UCUNA UYGUNDUR. FOR ISO INSERT.	3008-M2.5x5	80-T08
AEM90-AP09-D20-C20-L200-Z03-H	●	20	3	20	200	100	8.8			
AEM90-AP09-D20-C20-L250-Z02-H	●	20	2	20	250	150	8.8	AP.. 1003.. ISO UCUNA UYGUNDUR. FOR ISO INSERT.	3008-M2.5x5	80-T08
AEM90-AP09-D21-C20-L150-Z03	●	21	3	20	150	25	8.8			
AEM90-AP09-D26-C25-L150-Z04	●	26	4	25	150	30	8.8	AP.. 1003.. ISO UCUNA UYGUNDUR. FOR ISO INSERT.	3008-M2.5x5	80-T08
AEM90-AP10-D12-W16-L100-Z01-H	●	12	1	16	100	30	10			
AEM90-AP10-D12-W16-L150-Z01	●	12	1	16	150	38	10	AP.. 1003.. ISO UCUNA UYGUNDUR. FOR ISO INSERT.	3008-M2.5x5	80-T08
AEM90-AP10-D14-W16-L100-Z01-H	●	14	1	16	100	30	10			

R: Sağ/Right L: Sol/Left ● Stokta/In Stock ○ Stokta Yok/Non Stock Item

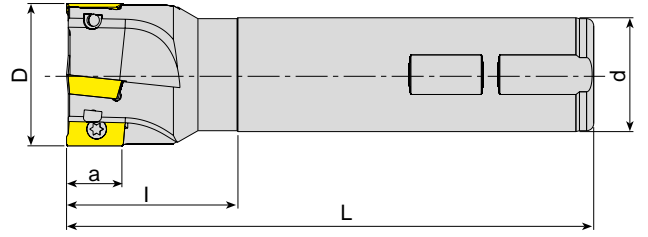
Sipariş Örneği/Ordering Example : 1 ad./pcs. AEM90-AN1607-D32-C25-L150-Z02

Kesme Hesabı : S 271 / Cutting Calculation : P 271



Takım Kodu Ordering Code	Stok Stock	Takım Ölçüleri (mm) Dimension (mm)						Kesici Uç Insert	Yedek Parçaları Spare Parts	
		D	Z	d	L	l	a		Sıkma Vidası Screw	Tork Anahtar Torx Key
AEM90-AP10-D14-W16-L150-Z01	●	14	1	16	150	38	10	 <b>AP.. 1003..</b> <b>ISO UCUNA UYGUNDUR.</b> <i>FOR ISO INSERT.</i>	 3008-M2.5x6	 80-T08
AEM90-AP10-D16-C16-L100-Z02-H	●	16	2	16	100	30	10			
AEM90-AP10-D16-W16-L100-Z02-H	●	16	2	16	100	30	10			
AEM90-AP10-D16-C16-L120-Z02-H	●	16	2	16	120	30	10			
AEM90-AP10-D16-C16-L150-Z02	●	16	2	16	150	50	10			
AEM90-AP10-D16-C16-L150-Z02-H	●	16	2	16	150	50	10			
AEM90-AP10-D16-W16-L150-Z02	●	16	2	16	150	50	10			
AEM90-AP10-D16-C16-L200-Z02	●	16	2	16	200	100	10			
AEM90-AP10-D16-C16-L200-Z02-H	●	16	2	16	200	100	10			
AEM90-AP10-D16-C16-L250-Z02	●	16	2	16	250	50	10			
AEM90-AP10-D18-W16-L100-Z02-H	●	18	2	16	100	30	10			
AEM90-AP10-D18-W16-L150-Z02	●	18	2	16	150	30	10			
AEM90-AP10-D20-C20-L100-Z03-H	●	20	3	20	100	30	10			
AEM90-AP10-D20-W20-L100-Z03-H	●	20	3	20	100	30	10			
AEM90-AP10-D20-C20-L120-Z03-H	●	20	3	20	120	30	10			
AEM90-AP10-D20-C20-L150-Z03	●	20	3	20	150	50	10			
AEM90-AP10-D20-C20-L150-Z03-H	●	20	3	20	150	50	10			
AEM90-AP10-D20-W20-L150-Z03	●	20	3	20	150	50	10			
AEM90-AP10-D20-C20-L200-Z02	●	20	2	20	200	100	10			
AEM90-AP10-D20-C20-L200-Z03-H	●	20	3	20	200	100	10			
AEM90-AP10-D20-C20-L250-Z02	●	20	2	20	250	150	10			
AEM90-AP10-D20-C20-L250-Z02-H	●	20	2	20	250	150	10			
AEM90-AP10-D21-W20-L150-Z03	●	21	3	20	150	30	10			
AEM90-AP10-D22-W20-L100-Z03-H	●	22	3	20	100	30	10			
AEM90-AP10-D22-W20-L150-Z03	●	22	3	20	150	30	10			
AEM90-AP10-D23-W20-L150-Z03	●	23	3	20	150	30	10			
AEM90-AP10-D24-W20-L150-Z03	●	24	3	20	150	30	10			
AEM90-AP10-D25-W25-L100-Z04-H	●	25	4	25	100	30	10			
AEM90-AP10-D25-C25-L100-Z03-H	●	25	3	25	100	30	10			
AEM90-AP10-D25-W25-L100-Z03-H	●	25	3	25	100	30	10			
AEM90-AP10-D25-C25-L120-Z03-H	●	25	3	25	120	30	10			
AEM90-AP10-D25-C25-L150-Z03	●	25	3	25	150	50	10			
AEM90-AP10-D25-W25-L150-Z03	●	25	3	25	150	50	10			
AEM90-AP10-D25-C25-L200-Z02	●	25	2	25	200	100	10			
AEM90-AP10-D25-C25-L200-Z03	●	25	3	25	200	100	10			
AEM90-AP10-D25-C25-L250-Z02	●	25	2	25	250	100	10			

R: Sağ/Right L: Sol/Left ● Stokta/In Stock ○ Stokta Yok/Non Stock Item





Sipariş Örneği/Ordering Example : 1 ad./pcs. AEM90-AP10-D14-W16-L150-Z01

Kesme Hesabı : S 271 / Cutting Calculation : P 271

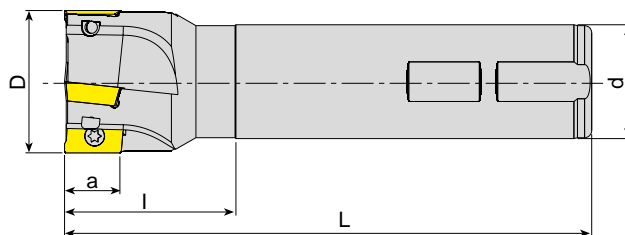

www.akkо.com.tr



Takım Kodu Ordering Code	Stok Stock	Takım Ölçüleri (mm) Dimension (mm)						Kesici Uç Insert	Yedek Parçaları Spare Parts	
		D	Z	d	L	l	a		Sıkma Vidası Screw	Tork Anahtar Torx Key
AEM90-AP10-D30-C25-L100-Z04-H	●	30	4	25	100	30	10	 <b>AP.. 1003..</b> ISO UCUNA UYGUNDUR. FOR ISO INSERT.		
AEM90-AP10-D30-C25-L120-Z04-H	●	30	4	25	120	30	10			
AEM90-AP10-D30-C25-L150-Z04	●	30	4	25	150	30	10			
AEM90-AP10-D32-C25-L100-Z04-H	●	32	4	25	100	35	10			
AEM90-AP10-D32-C25-L120-Z04-H	●	32	4	25	120	35	10			
AEM90-AP10-D32-C25-L150-Z04	●	32	4	25	150	35	10			
AEM90-AP10-D32-W25-L150-Z04	●	32	4	25	150	35	10			
AEM90-AP10-D32-W32-L150-Z04	●	32	4	32	150	50	10			
AEM90-AP10-D40-W32-L150-Z05	●	40	5	32	150	40	10	<b>AP.. 1003..</b> DJT UCUNA UYGUNDUR. FOR DJT INSERT		
AEM90-AP10D-D16-W16-L150-Z02	●	16	2	16	150	50	10			
AEM90-AP10D-D20-W20-L150-Z03	●	20	3	20	150	50	10	<b>AP.. 11T3..</b> ZCC UCUNA UYGUNDUR. FOR ZCC INSERT.	3008-M2.5x6	80-T08
AEM90-AP11-D16-C16-L150-Z02	●	16	2	16	150	50	11			
AEM90-AP11-D16-C16-L150-Z02-H	●	16	2	16	150	50	11			
AEM90-AP11-D16-W16-L150-Z02	●	16	2	16	150	50	11			
AEM90-AP11-D16-C16-L200-Z02	●	16	2	16	200	100	11			
AEM90-AP11-D17-C16-L150-Z02	●	17	2	16	150	30	11			
AEM90-AP11-D17-C16-L200-Z02	●	17	2	16	200	30	11			
AEM90-AP11-D20-C20-L150-Z03	●	20	3	20	150	50	11			
AEM90-AP11-D20-W20-L150-Z03	●	20	3	20	150	50	11			
AEM90-AP11-D20-W20-L150-Z03-H	●	20	3	20	150	50	11			
AEM90-AP11-D20-C20-L200-Z03	●	20	3	20	200	100	11			
AEM90-AP11-D21-C20-L150-Z03	●	21	3	20	150	30	11			
AEM90-AP11-D21-W20-L150-Z03	●	21	3	20	150	30	11			
AEM90-AP11-D21-W20-L150-Z03-H	●	21	3	20	150	30	11			
AEM90-AP11-D21-C20-L200-Z03	●	21	3	20	200	30	11			
AEM90-AP11-D25-C25-L150-Z03	●	25	3	25	150	50	11			
AEM90-AP11-D25-W25-L150-Z03	●	25	3	25	150	50	11			
AEM90-AP11-D25-W25-L150-Z03-H	●	25	3	25	150	50	11			
AEM90-AP11-D26-C25-L150-Z03	●	26	3	25	150	35	11			
AEM90-AP11-D26-C24-L150-Z03	●	26	3	24	150	47	11			
AEM90-AP11-D32-W25-L150-Z04	●	32	4	25	150	35	11			
AEM90-AP11-D32-W32-L150-Z03-H	●	32	3	32	150	50	11			
AEM90-AP11-D32-W32-L150-Z04	●	32	4	32	150	50	11			

R: Sağ/Right L: Sol/Left ● Stokta/In Stock ○ Stokta Yok/Non Stock Item

Sipariş Örneği/Ordering Example : 1 ad./pcs. AEM90-AP10-D30-C25-L100-Z04-H  
Kesme Hesabı : S 271 / Cutting Calculation : P 271

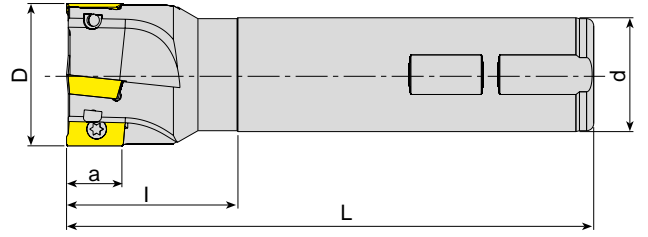

Takım Kodu Ordering Code	Stok Stock	Takım Ölçüleri (mm) Dimension (mm)						Kesici Uç Insert	Yedek Parçaları Spare Parts	
		D	Z	d	L	l	a		Sıkma Vidası Screw	Tork Anahtar Torx Key
AEM90-AP1135-D16-W16-L150-Z02	●	16	2	16	150	50	9.5	AP.. 1135.. GSC UCUNA UYGUNDUR. FOR GSC INSERT	3008-M2.5x6	80-T08
AEM90-AP1135-D20-W20-L150-Z03	●	20	3	20	150	50	9.5			
AEM90-AP1204-D20-C20-L150-Z02	●	20	2	20	150	30	12			
AEM90-AP1204-D21-C20-L150-Z02	●	21	2	20	150	30	12	AP.. 1204.. TGTC UCUNA UYGUNDUR. FOR TGTC INSERT.	1510-M3.5x7	80-T10
AEM90-AP1204-D21-C20-L200-Z02	●	21	2	20	200	30	12			
AEM90-AP1204-D25-C25-L150-Z03	●	25	3	25	150	40	12			
AEM90-AP1204-D26-C25-L250-Z02	●	26	2	25	250	35	12			
AEM90-AP1204-D32-C25-L150-Z03	●	32	3	25	150	35	12			
AEM90-AP16-D25-C20-L100-Z02	●	25	2	20	100	35	16			
AEM90-AP16-D25-W25-L100-Z02-H	●	25	2	25	100	35	16			
AEM90-AP16-D25-W25-L150-Z02	●	25	2	25	150	50	16			
AEM90-AP16-D25-C25-L250-Z02	●	25	2	25	250	100	16			
AEM90-AP16-D28-W25-L100-Z03-H	●	28	3	25	100	40	16			
AEM90-AP16-D28-W25-L150-Z03	●	28	3	25	150	40	16			
AEM90-AP16-D30-W25-L110-Z03-H	●	30	3	25	110	40	16			
AEM90-AP16-D30-W25-L150-Z02	●	30	2	25	150	40	16			
AEM90-AP16-D30-W25-L150-Z03	●	30	3	25	150	40	16			
AEM90-AP16-D32-W32-L110-Z03-H	●	32	3	32	110	40	16			
AEM90-AP16-D32-C32-L150-Z03	●	32	3	32	150	50	16			
AEM90-AP16-D32-W25-L150-Z03	●	32	3	25	150	40	16			
AEM90-AP16-D32-W32-L150-Z03	●	32	3	32	150	50	16			
AEM90-AP16-D32-W32-L150-Z03-H	●	32	3	32	150	50	16			
AEM90-AP16-D32-C25-L200-Z03-H	●	32	3	25	200	40	16			
AEM90-AP16-D32-C32-L250-Z02	●	32	2	32	250	100	16			
AEM90-AP16-D32-C32-L250-Z03	●	32	3	32	250	100	16			
AEM90-AP16-D35-W32-L150-Z03	●	35	3	32	150	40	16			
AEM90-AP16-D36-W32-L110-Z03-H	●	36	3	32	110	40	16			
AEM90-AP16-D36-W32-L150-Z03	●	36	3	32	150	40	16			
AEM90-AP16-D40-W32-L110-Z04-H	●	40	4	32	110	40	16			
AEM90-AP16-D40-C32-L150-Z04	●	40	4	32	150	40	16			
AEM90-AP16-D40-W32-L150-Z04	●	40	4	32	150	40	16			
AEM90-AP16-D40-C32-L250-Z02	●	40	2	32	250	40	16			
AEM90-AP16-D40-C32-L250-Z04	●	40	4	32	250	40	16			

R: Sağ/Right L: Sol/Left ● Stokta/In Stock ○ Stokta Yok/Non Stock Item

Sipariş Örneği/Ordering Example : 1 ad./pcs. AEM90-AP1135-D16-W16-L150-Z02

Kesme Hesabı : S 271 / Cutting Calculation : P 271

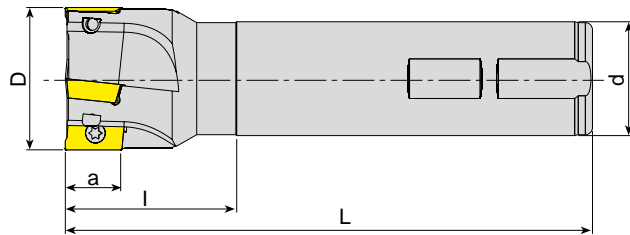

Takım Kodu Ordering Code	Stok Stock	Takım Ölçüleri (mm) Dimension (mm)						Kesici Uç Insert	Yedek Parçaları Spare Parts	
		D	Z	d	L	l	a		Sıkma Vidası Screw	Tork Anahtar Torx Key
AEM90-AP16DJ-D25-W25-L150-Z02	●	25	2	25	150	50	16	AP.. 1604.. DJT UCUNA UYGUNDUR. FOR DJT INSERT.		
AEM90-AP16DJ-D25-C25-L200-Z02	●	25	2	25	200	50	16			
AEM90-AP16DJ-D32-W32-L150-Z03	●	32	3	32	150	50	16			
AEM90-AP16DJ-D32-C32-L180-Z03	●	32	3	32	180	50	16	AP.. 1604.. LMN UCUNA UYGUNDUR. FOR LMN INSERT.	1515-M4x9	80-T15
AEM90-AP16DJ-D32-C32-L200-Z03	●	32	3	32	200	50	16			
AEM90-AP16L-D25-C25-L120-Z02-H	●	25	2	25	120	45	16			
AEM90-AP16L-D25-C25-L150-Z02	●	25	2	25	150	55	16	AP.. 1604.. LMN UCUNA UYGUNDUR. FOR LMN INSERT.	1515-M4x9	80-T15
AEM90-AP16L-D25-C25-L200-Z02	●	25	2	25	200	55	16			
AEM90-AP16L-D25-C25-L250-Z02	●	25	2	25	250	100	16			
AEM90-AP16L-D32-C32-L120-Z03-H	●	32	3	32	120	45	16	AP.. 1604.. PLBT UCUNA UYGUNDUR. FOR PLBT INSERT.	1515-M4x9	80-T15
AEM90-AP16L-D32-C32-L150-Z03	●	32	3	32	150	55	16			
AEM90-AP16L-D32-C32-L200-Z03	●	32	3	32	200	55	16			
AEM90-AP16L-D32-C32-L250-Z03	●	32	3	32	250	100	16	AP.. 1705.. TGTC-LMN UCUNA UYGUNDUR. FOR TGTC-LMN INSERT.	1515-M4x9	80-T15
AEM90-AP16L-D40-C32-L120-Z04-H	●	40	4	32	120	40	16			
AEM90-AP16L-D40-C32-L150-Z04	●	40	4	32	150	40	16			
AEM90-AP16L-D40-C32-L200-Z04	●	40	4	32	200	40	16	AP.. 1705.. TGTC-LMN UCUNA UYGUNDUR. FOR TGTC-LMN INSERT.	1515-M4x9	80-T15
AEM90-AP16L-D40-C32-L250-Z04	●	40	4	32	250	40	16			
AEM90-AP16P-D25-W25-L100-Z02-H	●	25	2	25	100	35	16			
AEM90-AP16P-D25-W25-L150-Z02	●	25	2	25	150	50	16	AP.. 1705.. TGTC-LMN UCUNA UYGUNDUR. FOR TGTC-LMN INSERT.	1515-M4x9	80-T15
AEM90-AP16P-D32-W32-L150-Z03	●	32	3	32	150	50	16			
AEM90-AP16P-D32-C32-L250-Z02	●	32	2	32	250	100	16			
AEM90-AP16P-D40-W32-L150-Z04	●	40	4	32	150	50	16	AP.. 1705.. TGTC-LMN UCUNA UYGUNDUR. FOR TGTC-LMN INSERT.	1515-M4x9	80-T15
AEM90-AP1705-D25-C25-L120-Z02	●	25	2	25	120	40	16			
AEM90-AP1705-D26-C25-L200-Z02	●	26	2	25	200	40	16			
AEM90-AP1705-D26-C25-L250-Z02	●	26	2	25	250	40	16	AP.. 1705.. TGTC-LMN UCUNA UYGUNDUR. FOR TGTC-LMN INSERT.	1515-M4x9	80-T15
AEM90-AP1705-D28-W25-L075-Z02	●	28	2	25	75	20	16			
AEM90-AP1705-D32-C25-L150-Z03	●	32	3	25	150	40	16			
AEM90-AP1705-D33-C32-L300-Z02	●	33	2	32	300	40	16	AP.. 1705.. TGTC-LMN UCUNA UYGUNDUR. FOR TGTC-LMN INSERT.	1515-M4x9	80-T15

R: Sağ/Right L: Sol/Left ● Stokta/In Stock ○ Stokta Yok/Non Stock Item

Sipariş Örneği/Ordering Example : 1 ad./pcs. AEM90-AP16DJ-D25-W25-L150-Z02  
Kesme Hesabı : S 271 / Cutting Calculation : P 271



90°

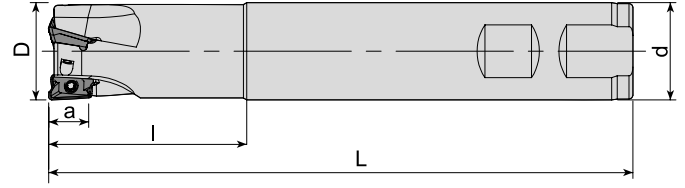

Takım Kodu Ordering Code	Stok Stock	Takım Ölçüleri (mm) Dimension (mm)						Kesici Uç Insert	Yedek Parçaları Spare Parts	
		D	Z	d	L	l	a		Sıkma Vidası Screw	Tork Anahtar Torx Key
AEM90-AO1236-D16-W16-L150-Z02	●	16	2	16	150	50	12			
AEM90-AO1236-D25-W25-L150-Z03	●	25	3	25	150	50	12			
AEM90-AO1236-D32-W32-L150-Z04	●	32	4	32	150	50	12			

MTSBH Ucuna Uygunudur. / Compatible with MTSBH Insert.

90°

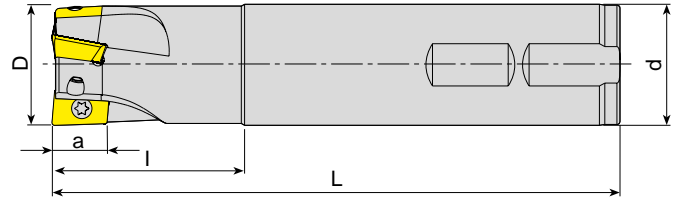

Takım Kodu Ordering Code	Stok Stock	Takım Ölçüleri (mm) Dimension (mm)						Kesici Uç Insert	Yedek Parçaları Spare Parts	
		D	Z	d	L	l	a		Sıkma Vidası Screw	Tork Anahtar Torx Key
AEM90-AX0602-D10-C10-L120-Z02	●	10	2	10	120	20	5.7			
AEM90-AX0602-D12-C12-L120-Z02	●	12	2	12	120	20	5.7			
AEM90-AX0602-D14-C12-L120-Z03	●	14	3	12	120	20	5.7			
AEM90-AX0602-D16-W16-L120-Z04-H	●	16	4	16	120	20	5.7			
AEM90-AX0602-D16-W16-L150-Z04-H	●	16	4	16	150	20	5.7			
AEM90-AX0602-D20-W20-L120-Z05-H	●	20	5	20	120	25	5.7			
AEM90-AX0602-D20-W20-L150-Z05-H	●	20	5	20	150	25	5.7			
AEM90-AX0903-D16-C16-L120-Z02	●	16	2	16	120	30	8.8			
AEM90-AX0903-D16-C16-L180-Z02	●	16	2	16	180	30	8.8			
AEM90-AX0903-D17-C16-L120-Z02	●	17	2	16	120	25	8.8			
AEM90-AX0903-D17-C16-L180-Z02	●	17	2	16	180	25	8.8			
AEM90-AX0903-D20-C20-L120-Z03	●	20	3	20	120	30	8.8			
AEM90-AX0903-D20-C20-L200-Z02	●	20	2	20	200	30	8.8			
AEM90-AX0903-D21-C20-L120-Z03	●	21	3	20	120	25	8.8			
AEM90-AX0903-D21-C20-L200-Z02	●	21	2	20	200	25	8.8			
AEM90-AX0903-D25-C25-L150-Z03	●	25	3	25	150	30	8.8			
AEM90-AX0903-D25-C25-L250-Z02	●	25	2	25	250	40	8.8			
AEM90-AX0903-D26-C25-L150-Z03	●	26	3	25	150	30	8.8			

R: Sağ/Right L: Sol/Left ● Stokta/In Stock ○ Stokta Yok/Non Stock Item  
TGTC Ucuna Uygunudur. / Compatible with TGTC Insert.

Sipariş Örneği/Ordering Example : 1 ad./pcs. AEM90-AO1236-D16-W16-L150-Z02  
Kesme Hesabı : S 271 / Cutting Calculation : P 271



www.akkо.com.tr

90°

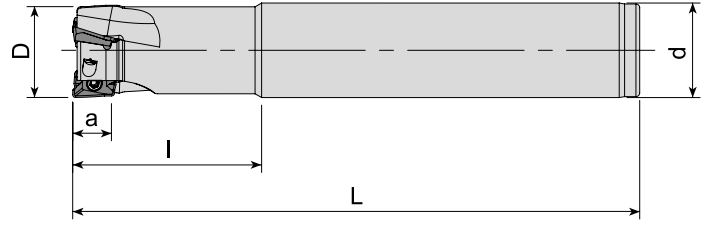

Takım Kodu Ordering Code	Stok Stock	Takım Ölçüleri (mm) Dimension (mm)						Kesici Uç Insert	Yedek Parçaları Spare Parts			
		D	Z	d	L	l	a		Sıkma Vidası Screw	Tork Anahtar Torx Key		
AEM90-AX1235-D16-C14-L120-Z02-H	●	16	2	14	120	25	10		1008-M3x6			
AEM90-AX1235-D16-C15-L145-Z02-H	●	16	2	15	145	30	10		3108-M3x6			
AEM90-AX1235-D16-C16-L100-Z02-H	●	16	2	16	100	30	10		1008-M3x6			
AEM90-AX1235-D16-C16-L140-Z02-H	●	16	2	16	140	30	10		3108-M3x6			
AEM90-AX1235-D16-C16-L145-Z02-H	●	16	2	16	145	30	10		1008-M3x6			
AEM90-AX1235-D16-C16-L150-Z02	●	16	2	16	150	30	10		3108-M3x6			
AEM90-AX1235-D20-C19-L150-Z02-H	●	20	2	19	150	40	10		1008-M3x6			
AEM90-AX1235-D20-C20-L110-Z03-H	●	20	3	20	110	40	10		3108-M3x6			
AEM90-AX1235-D20-C20-L150-Z02	●	20	2	20	150	40	10		1008-M3x6			
AEM90-AX1235-D20-C20-L150-Z02-H	●	20	2	20	150	40	10		3108-M3x6			
AEM90-AX1235-D20-C20-L150-Z03	●	20	3	20	150	40	10		1008-M3x6			
AEM90-AX1235-D25-C20-L120-Z04-H	●	25	4	20	120	30	10		3108-M3x6			
AEM90-AX1235-D25-C20-L150-Z04-H	●	25	4	20	150	30	10		1008-M3x6			
AEM90-AX1235-D25-C24-L170-Z02-H	●	25	2	24	170	50	10		3108-M3x6			
AEM90-AX1235-D25-C25-L120-Z04-H	●	25	4	25	120	40	10		1008-M3x6			
AEM90-AX1235-D25-C25-L150-Z03	●	25	3	25	150	50	10		3108-M3x6			
AEM90-AX1235-D25-C25-L170-Z02-H	●	25	2	25	170	50	10		1008-M3x6			
AEM90-AX1235-D25-W25-L100-Z04-H	●	25	4	25	100	30	10		3108-M3x6			
AEM90-AX1235-D32-C32-L130-Z05-H	●	32	5	32	130	40	10				4015-M4x9	80-T15
AEM90-AX1705-D25-C25-L150-Z02	●	25	2	25	150	50	14					
AEM90-AX1705-D28-W25-L115-Z02-H	●	28	2	25	115	35	14					
AEM90-AX1705-D32-C32-L150-Z03	●	32	3	32	150	50	14					
AEM90-AX1705-D32-C32-L180-Z02-H	●	32	2	32	180	50	14					



R: Sağ/Right L: Sol/Left ● Stokta/In Stock ○ Stokta Yok/Non Stock Item  
SMTM Ucuna Uygunudur. / Compatible with SMTM Insert.

Sipariş Örneği/Ordering Example : 1 ad./pcs. AEM90-AX1235-D16-C14-L120-Z02-H  
Kesme Hesabı : S 271 / Cutting Calculation : P 271

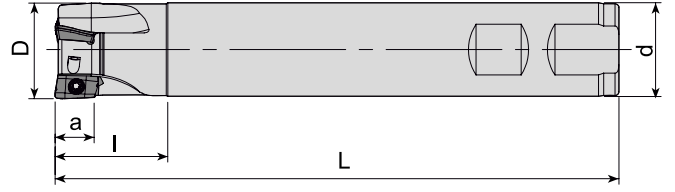

90°







Takım Kodu Ordering Code	Stok Stock	Takım Ölçüleri (mm) Dimension (mm)						Kesici Uç Insert	Yedek Parçaları Spare Parts	
		D	Z	d	L	l	a		Sıkma Vidası Screw	Tork Anahtar Torx Key
AEM90-AZ11-D12-W16-L90-Z01	●	12	1	16	90	30	11			
AEM90-AZ11-D16-C16-L200-Z02	●	16	2	16	200	100	11			
AEM90-AZ11-D16-W15-L170-Z02	●	16	2	15	170	50	11			
AEM90-AZ11-D16-W16-L100-Z02	●	16	2	16	100	35	11			
AEM90-AZ11-D16-W16-L150-Z02	●	16	2	16	150	50	11			
AEM90-AZ11-D17-C16-L150-Z02	●	17	2	16	150	30	11			
AEM90-AZ11-D17-C16-L180-Z02	●	17	2	16	180	50	11			
AEM90-AZ11-D17-W16-L100-Z02	●	17	2	16	100	30	11			
AEM90-AZ11-D20-C20-L200-Z03	●	20	3	20	200	100	11			
AEM90-AZ11-D20-W19-L170-Z03	●	20	3	19	170	50	11			
AEM90-AZ11-D20-W20-L110-Z02	●	20	2	20	110	35	11			
AEM90-AZ11-D21-C20-L150-Z03	●	21	3	20	150	30	11			
AEM90-AZ11-D21-C20-L180-Z03	●	21	3	20	180	50	11			
AEM90-AZ11-D21-W20-L110-Z03	●	21	3	20	110	35	11			
AEM90-AZ11-D25-C24-L180-Z04	●	25	4	24	180	50	11			
AEM90-AZ11-D25-W25-L110-Z04	●	25	4	25	110	40	11			
AEM90-AZ11-D26-C25-L250-Z02	●	26	2	25	250	50	11			
AEM90-AZ11-D26-W25-L120-Z03	●	26	3	25	120	30	11			
AEM90-AZ11-D26-W25-L120-Z04	●	26	4	25	120	40	11			
AEM90-AZ11-D28-C25-L250-Z02	●	28	2	25	250	50	11			
AEM90-AZ11-D33-W32-L130-Z04	●	33	4	32	130	50	11			

R: Sağ/Right L: Sol/Left ● Stokta/In Stock ○ Stokta Yok/Non Stock Item  
ZCC Ucuna Uygunudur. / Compatiple with ZCC Insert.

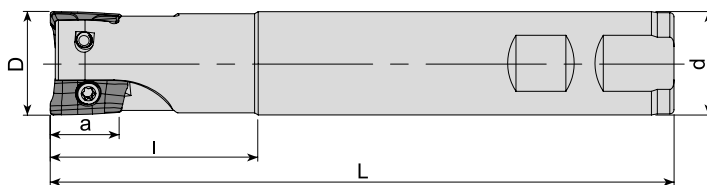
Sipariş Örneği/Ordering Example : 1 ad./pcs. AEM90-AZ11-D12-W16-L90-Z01  
Kesme Hesabı : S 271 / Cutting Calculation : P 271



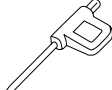

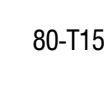
Takım Kodu Ordering Code	Stok Stock	Takım Ölçüleri (mm) Dimension (mm)						Kesici Uç Insert	Yedek Parçaları Spare Parts	
		D	Z	d	L	l	a		Sıkma Vidası Screw	Tork Anahtar Torx Key
AEM90-BD11T3-D16-W16-L100-Z02-H	●	16	2	16	100	30	10			
AEM90-BD11T3-D16-W16-L150-Z02	●	16	2	16	150	50	10			
AEM90-BD11T3-D17-W16-L150-Z02	●	17	2	16	150	50	10			
AEM90-BD11T3-D18-W16-L100-Z02-H	●	18	2	16	100	25	10			
AEM90-BD11T3-D20-W20-L100-Z03-H	●	20	3	20	100	30	10			
AEM90-BD11T3-D20-W20-L150-Z03	●	20	3	20	150	50	10			
AEM90-BD11T3-D21-W20-L150-Z03	●	21	3	20	150	50	10			
AEM90-BD11T3-D22-W20-L090-Z02-H	●	22	2	20	90	25	10			
AEM90-BD11T3-D25-W25-L100-Z03-H	●	25	3	25	100	30	10			
AEM90-BD11T3-D25-W25-L150-Z03	●	25	3	25	150	50	10			
AEM90-BD11T3-D26-W25-L150-Z03	●	26	3	25	150	50	10			
AEM90-BD11T3-D32-W32-L110-Z04-H	●	32	4	32	110	40	10			
AEM90-BD11T3-D32-W32-L150-Z04	●	32	4	32	150	50	10			
AEM90-BD11T3-D40-W32-L110-Z04-H	●	40	4	32	110	50	10			
AEM90-BD1704-D25-W25-L100-Z02-H	●	25	2	25	100	35	15.7			
AEM90-BD1704-D25-W25-L150-Z02	●	25	2	25	150	50	15.7			
AEM90-BD1704-D32-W32-L110-Z03-H	●	32	3	32	110	40	15.7			
AEM90-BD1704-D32-W32-L150-Z03	●	32	3	32	150	50	15.7			
AEM90-BD1704-D40-W32-L110-Z04-H	●	40	4	32	110	40	15.7			
AEM90-BD1704-D40-W32-L150-Z04	●	40	4	32	150	40	15.7			

R: Sağ/Right L: Sol/Left ● Stokta/In Stock ○ Stokta Yok/Non Stock Item  
KYCR Ucuna Uygundur. / Compatible with KYCR Insert.

Sipariş Örneği/Ordering Example : 1 ad./pcs. AEM90-BD11T3-D16-W16-L100-Z02-H  
Kesme Hesabı : S 271 / Cutting Calculation : P 271

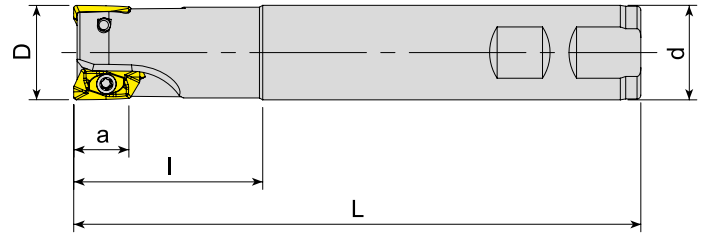

Takım Kodu Ordering Code	Stok Stock	Takım Ölçüleri (mm) Dimension (mm)						Kesici Uç Insert	Yedek Parçaları Spare Parts	
		D	Z	d	L	l	a		Sıkma Vidası Screw	Tork Anahtar Torx Key
AEM90-ED1404-D20-W20-L150-Z02	●	20	2	20	150	50	14.5			
AEM90-ED1404-D25-W25-L150-Z02	●	25	2	25	150	50	14.5			
AEM90-ED1404-D30-C25-L150-Z03	●	30	3	25	150	50	14.5			

KNMNTL Ucuna Uygunudur. / Compatiple with KNMNTL Insert.

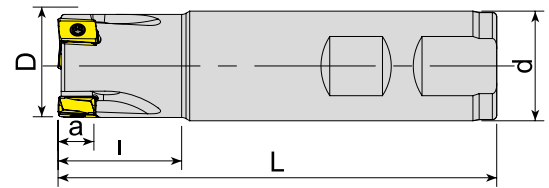

Takım Kodu Ordering Code	Stok Stock	Takım Ölçüleri (mm) Dimension (mm)						Kesici Uç Insert	Yedek Parçaları Spare Parts	
		D	Z	d	L	l	a		Sıkma Vidası Screw	Tork Anahtar Torx Key
AEM90-LN08-D16-W16-L100-Z02-H	●	16	2	16	100	28	8			
AEM90-LN08-D20-W20-L100-Z03-H	●	20	3	20	100	28	8			
AEM90-LN08-D25-W25-L100-Z03-H	●	25	3	25	100	30	8			
AEM90-LN08-D32-W32-L110-Z05-H	●	32	5	32	110	30	8			

R: Sağ/Right L: Sol/Left ● Stokta/In Stock ○ Stokta Yok/Non Stock Item  
ISCR Ucuna Uygunudur. / Compatiple with ISCR Insert.

Sipariş Örneği/Ordering Example : 1 ad./pcs. AEM90-ED1404-D20-W20-L150-Z02  
Kesme Hesabı : S 271 / Cutting Calculation : P 271

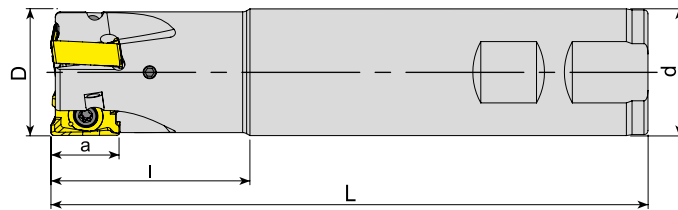

Takım Kodu Ordering Code	Stok Stock	Takım Ölçüleri (mm) Dimension (mm)						Kesici Uç Insert	Yedek Parçaları Spare Parts	
		D	Z	d	L	l	a		Sıkma Vidası Screw	Tork Anahtar Torx Key
AEM90-LN15T6-D25-W25-L150-Z02-H	●	25	2	25	150	50	15.5	LNGU 15T6..	4015-M4x12	80-T15
AEM90-LN15T6-D32-W32-L150-Z03-H	●	32	3	32	150	50	15.5			
AEM90-LN15T6-D40-W32-L150-Z03-H	●	40	3	32	150	40	15.5			

KNMTL Ucuna Uygundur. / Compatiple with KNMTL Insert.

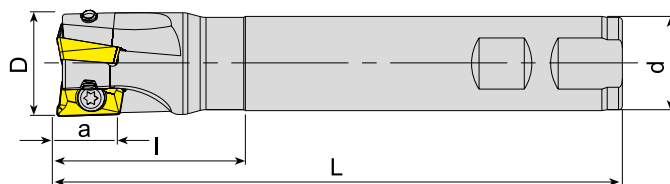

Takım Kodu Ordering Code	Stok Stock	Takım Ölçüleri (mm) Dimension (mm)						Kesici Uç Insert	Yedek Parçaları Spare Parts				
		D	Z	d	L	l	a		Sıkma Vidası Screw	Tork Anahtar Torx Key			
AEM90-R390.11-D16-W16-L100-Z02-H	●	16	2	16	100	30	10	R390-11T3..	3008-M2.5x6	80-T08			
AEM90-R390.11-D16-W16-L150-Z02	●	16	2	16	150	50	10						
AEM90-R390.11-D16-W16-L150-Z02-H	●	16	2	16	150	50	10						
AEM90-R390.11-D20-W20-L090-Z02-H	●	20	2	20	90	30	10						
AEM90-R390.11-D20-W20-L100-Z03-H	●	20	3	20	100	30	10						
AEM90-R390.11-D20-W20-L150-Z03	●	20	3	20	150	50	10						
AEM90-R390.11-D20-W20-L150-Z03-H	●	20	3	20	150	50	10						
AEM90-R390.11-D20-C20-L150-Z03	●	20	3	20	150	30	10						
AEM90-R390.11-D22-W20-L090-Z02-H	●	22	2	20	90	30	10						
AEM90-R390.11-D25-C20-L150-Z03	●	25	3	20	150	40	10						
AEM90-R390.11-D25-W25-L100-Z03-H	●	25	3	25	100	30	10						
AEM90-R390.11-D25-W25-L150-Z03	●	25	3	25	150	50	10						
AEM90-R390.11-D25-W25-L150-Z03-H	●	25	3	25	150	50	10						
AEM90-R390.11-D30-W25-L150-Z04-H	●	30	4	25	150	30	10						
AEM90-R390.11-D32-C25-L200-Z03	●	32	3	25	200	40	10						
AEM90-R390.11-D32-W32-L150-Z05-H	●	32	5	32	150	50	10						
AEM90-R390.17-D25-W25-L150-Z02	●	25	2	25	150	50	15.4				R390-1704..	4015-M3.5x8	80-T15
AEM90-R390.17-D25-W25-L150-Z02-H	●	25	2	25	150	50	15.4						
AEM90-R390.17-D30-W25-L150-Z03	●	30	3	25	150	40	15.4						
AEM90-R390.17-D30-W25-L150-Z03-H	●	30	3	25	150	40	15.4						
AEM90-R390.18-D32-C32-L150-Z03	●	32	3	32	150	45	15.4	R390-1806..	4015-M4x11				

R: Sağ/Right L: Sol/Left ● Stokta/In Stock ○ Stokta Yok/Non Stock Item  
SNDVK Ucuna Uygundur. / Compatiple with SNDVK Insert.

Sipariş Örneği/Ordering Example : 1 ad./pcs. AEM90-LN15T6-D25-W25-L150-Z02-H  
Kesme Hesabı : S 271 / Cutting Calculation : P 271

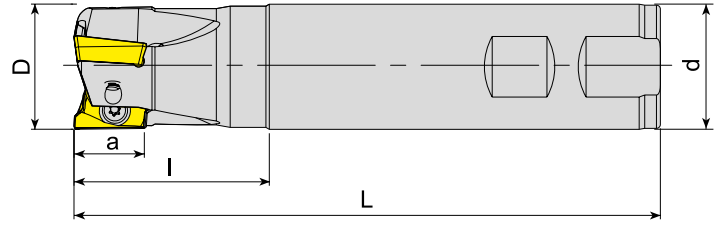

Takım Kodu Ordering Code	Stok Stock	Takım Ölçüleri (mm) Dimension (mm)						Kesici Uç Insert	Yedek Parçaları Spare Parts	
		D	Z	d	L	l	a		Sıkma Vidası Screw	Tork Anahtar Torx Key
AEM90-RT07-D10-W10-L120-Z02	●	10	2	10	120	30	7	RT 0702	3006-M2x4	80-T06
AEM90-RT07-D12-C12-L120-Z02	●	12	2	12	120	30	7			
AEM90-RT07-D12-W12-L120-Z02	●	12	2	12	120	30	7			
AEM90-RT07-D14-W12-L120-Z02	●	14	2	12	120	30	7			
AEM90-RT10-D16-C15-L160-Z02	●	16	2	15	160	30	10	RT 1003	3008-M2.5x6	80-T08
AEM90-RT10-D16-W16-L120-Z02-H	●	16	2	16	120	30	10			
AEM90-RT10-D16-W16-L150-Z02	●	16	2	16	150	50	10			
AEM90-RT10-D16-C16-L200-Z02	●	16	2	16	200	100	10			
AEM90-RT10-D17-W16-L160-Z02	●	17	2	16	160	30	10			
AEM90-RT10-D17-C16-L200-Z02	●	17	2	16	200	30	10			
AEM90-RT10-D18-W16-L120-Z02-H	●	18	2	16	120	30	10			
AEM90-RT10-D20-C19-L200-Z03	●	20	3	19	200	30	10			
AEM90-RT10-D20-W20-L120-Z03-H	●	20	3	20	120	30	10			
AEM90-RT10-D20-W20-L150-Z03	●	20	3	20	150	50	10			
AEM90-RT10-D20-C20-L200-Z03	●	20	3	20	200	100	10			
AEM90-RT10-D21-W20-L200-Z03	●	21	3	20	200	30	10			
AEM90-RT10-D22-W20-L120-Z03-H	●	22	3	20	120	30	10			
AEM90-RT10-D22-C20-L150-Z03	●	22	3	20	150	30	10			
AEM90-RT10-D22-C20-L200-Z03	●	22	3	20	200	30	10			
AEM90-RT10-D25-W25-L120-Z04-H	●	25	4	25	120	40	10			
AEM90-RT10-D25-W25-L150-Z04	●	25	4	25	150	50	10			
AEM90-RT10-D25-C25-L200-Z04	●	25	4	25	200	100	10			
AEM90-RT10-D26-C25-L250-Z04	●	26	4	25	250	32	10			
AEM90-RT10-D32-W32-L120-Z05-H	●	32	5	32	120	50	10			
AEM90-RT10-D32-W32-L150-Z05	●	32	5	32	150	50	10			
AEM90-RT10-D32-C32-L200-Z05	●	32	5	32	200	100	10			
AEM90-RT10-D33-C32-L250-Z04	●	33	4	32	250	32	10			
AEM90-RT13-D32-C32-L250-Z04	●	32	4	32	250	50	13	RT 1304	1008-M3x8	
AEM90-RT16-D25-W25-L120-Z02-H	●	25	2	25	120	40	16	RT 1606	4015-M4x9	80-T15
AEM90-RT16-D25-W25-L150-Z02	●	25	2	25	150	50	16			
AEM90-RT16-D25-C25-L200-Z02	●	25	2	25	200	100	16			
AEM90-RT16-D32-W32-L120-Z03-H	●	32	3	32	120	50	16			
AEM90-RT16-D32-W32-L150-Z03	●	32	3	32	150	50	16			
AEM90-RT16-D32-C32-L200-Z03	●	32	3	32	200	100	16			
AEM90-RT16-D32-C32-L250-Z03	●	32	3	32	250	100	16			
AEM90-RT16-D32-C32-L270-Z03	●	32	3	32	270	100	16			
AEM90-RT16-D40-W32-L120-Z04-H	●	40	4	32	120	50	16			
AEM90-RT16-D40-W32-L150-Z04	●	40	4	32	150	50	16			
AEM90-RT16-D40-C32-L200-Z04	●	40	4	32	200	100	16			

R: Sağ/Right L: Sol/Left ● Stokta/In Stock ○ Stokta Yok/Non Stock Item  
SFTY Ucuna Uygunudur. / Compatible with SFTY Insert.

Sipariş Örneği/Ordering Example : 1 ad./pcs. AEM90-RT07-D10-W10-L120-Z02  
Kesme Hesabı : S 271 / Cutting Calculation : P 271

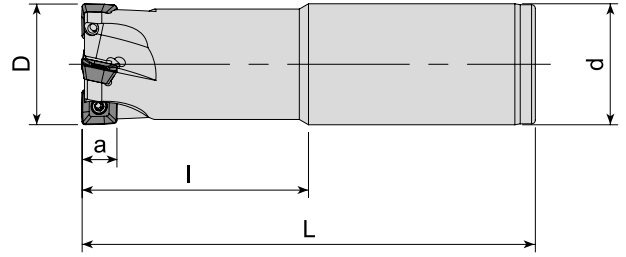

Takım Kodu Ordering Code	Stok Stock	Takım Ölçüleri (mm) Dimension (mm)						Kesici Uç Insert	Yedek Parçaları Spare Parts	
		D	Z	d	L	l	a		Sıkma Vidası Screw	Tork Anahtar Torx Key
AEM90-SE09-D25-C25-L120-Z03-H	●	25	3	25	120	60	6.7	SEET 09T3..	1008-M3x8	80-T08
AEM90-SE09-D25-C25-L150-Z02	●	25	2	25	150	50	6.7			
AEM90-SE09-D32-C32-L120-Z04-H	●	32	4	32	120	60	6.7			
AEM90-SE09-D32-C32-L150-Z03	●	32	3	32	150	50	6.7			

ZCC Ucuna Uygundur. / Compatible with ZCC Insert.

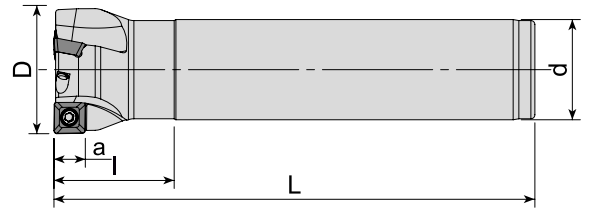

Takım Kodu Ordering Code	Stok Stock	Takım Ölçüleri (mm) Dimension (mm)						Kesici Uç Insert	Yedek Parçaları Spare Parts	
		D	Z	d	L	l	a		Sıkma Vidası Screw	Tork Anahtar Torx Key
AEM90-S00803-D20-C16-L110-Z02-H	●	20	2	16	110	25	7	SOMT 0803..	3008-M3x7	80-T08
AEM90-S00803-D25-C20-L110-Z02-H	●	25	2	20	110	25	7			
AEM90-S00803-D32-C25-L120-Z03-H	●	32	3	25	120	30	7			

R: Sağ/Right L: Sol/Left ● Stokta/In Stock ○ Stokta Yok/Non Stock Item  
SMTM Ucuna Uygundur. / Compatible with SMTM Insert.

Sipariş Örneği/Ordering Example : 1 ad./pcs. AEM90-SE09-D25-C25-L120-Z03-H  
Kesme Hesabı : S 271 / Cutting Calculation : P 271

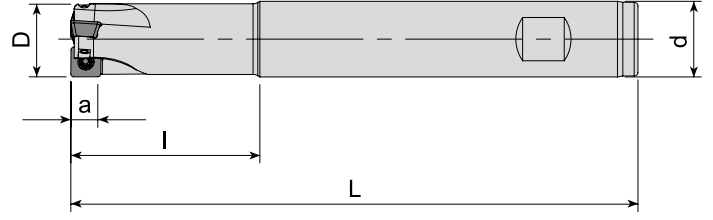

Takım Kodu Ordering Code	Stok Stock	Takım Ölçüleri (mm) Dimension (mm)						Yedek Parçaları Spare Parts		
		D	Z	d	L	l	a	Kesici Uç Insert	Sıkma Vidası Screw	Tork Anahtar Torx Key
AEM90-SPGT0602-D16-W16-L150-Z02	●	16	2	16	150	50	5.5		3007-M2.2x5	80-T07
AEM90-SPGT07T3-D20-W20-L150-Z03	●	20	3	20	150	50	7		3008-M2.5x6	80-T08
AEM90-SPGT07T3-D25-W25-L150-Z03	●	25	3	25	150	50	7		3008-M2.5x6	80-T08
AEM90-SPGT0904-D30-W32-L150-Z03	●	30	3	32	150	50	9		4015-M3.5x9	80-T15

ZCC Ucuna Uygunudur. / Compatible with ZCC Insert.

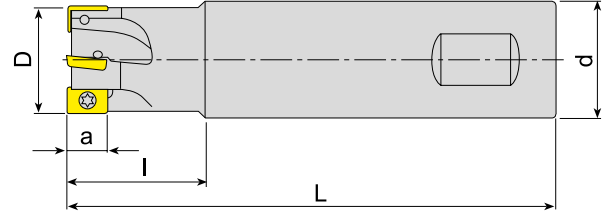



Takım Kodu Ordering Code	Stok Stock	Takım Ölçüleri (mm) Dimension (mm)						Yedek Parçaları Spare Parts		
		D	Z	d	L	l	a	Kesici Uç Insert	Sıkma Vidası Screw	Tork Anahtar Torx Key
AEM90-XC13-D20-W20-L150-Z02	●	20	2	20	150	60	13		1008-M3x6	80-T08
AEM90-XC13-D25-W25-L150-Z03	●	25	3	25	150	60	13	<b>XCKX 13T3..</b>	1008-M3x8	
AEM90-XC13-D32-W32-L150-Z04	●	32	4	32	150	60	13			

R: Sağ/Right L: Sol/Left ● Stokta/In Stock ○ Stokta Yok/Non Stock Item  
SC Ucuna Uygunudur. / Compatible with SC Insert.

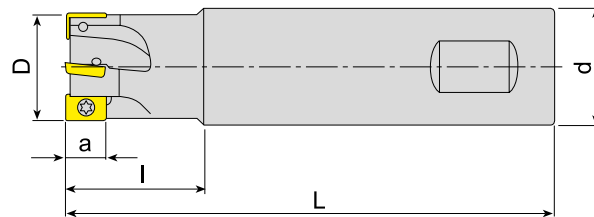



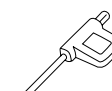

Sipariş Örneği/Ordering Example : 1 ad./pcs. AEM90-SPGT0602-D16-W16-L150-Z02  
Kesme Hesabı : S 271 / Cutting Calculation : P 271

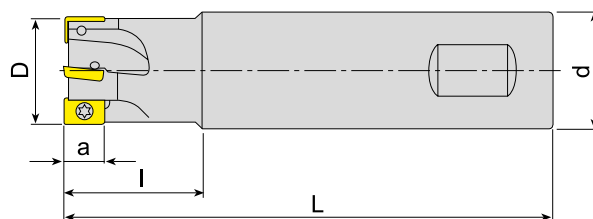

Takım Kodu Ordering Code	Stok Stock	Takım Ölçüleri (mm) Dimension (mm)						Kesici Uç Insert	Yedek Parçaları Spare Parts	
		D	Z	d	L	l	a		Sıkma Vidası Screw	Tork Anahtar Torx Key
AEM90-XD11T3-D16-W16-L150-Z02	●	16	2	16	150	30	10			
AEM90-XD11T3-D17-C16-L150-Z02	●	17	2	16	150	30	10			
AEM90-XD11T3-D20-W20-L150-Z03	●	20	3	20	150	50	10			
AEM90-XD11T3-D21-C20-L150-Z03	●	21	3	20	150	30	10			
AEM90-XD11T3-D25-W25-L150-Z04	●	25	4	25	150	50	10			
AEM90-XD11T3-D32-W32-L150-Z04	●	32	4	32	150	50	10			

CRTZT Ucuna Uygun. / Compatiple with CRTZT Insert.

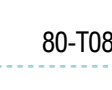
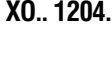

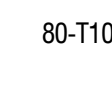

Takım Kodu Ordering Code	Stok Stock	Takım Ölçüleri (mm) Dimension (mm)						Kesici Uç Insert	Yedek Parçaları Spare Parts	
		D	Z	d	L	l	a		Sıkma Vidası Screw	Tork Anahtar Torx Key
AEM90-X006-D10-C12-L120-Z02	●	10	2	12	120	50	5			
AEM90-X006-D12-C12-L120-Z02	●	12	2	12	120	25	5			
AEM90-X009-D16-W16-L150-Z02	●	16	2	16	150	50	8			
AEM90-X009-D20-W20-L150-Z03	●	20	3	20	150	50	8			
AEM90-X012-D20-W20-L150-Z02	●	20	2	20	150	50	11			
AEM90-X012-D20-C20-L200-Z02	●	20	2	20	200	100	11			
AEM90-X012-D22-W20-L150-Z02	●	22	2	20	150	30	11			
AEM90-X012-D25-W25-L150-Z03	●	25	3	25	150	50	11			
AEM90-X012-D25-C25-L200-Z03	●	25	3	25	200	100	11			
AEM90-X012-D32-C25-L150-Z04	●	32	4	25	150	40	11			
AEM90-X012-D32-W32-L150-Z04	●	32	4	32	150	50	11			
AEM90-X012-D32-C32-L250-Z04	●	32	4	32	250	100	11			

R: Sağ/Right L: Sol/Left ● Stokta/In Stock ○ Stokta Yok/Non Stock Item  
SC Ucuna Uygun. / Compatiple with SC Insert.

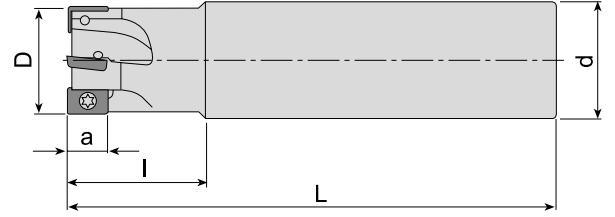

Sipariş Örneği/Ordering Example : 1 ad./pcs. AEM90-XD11T3-D16-W16-L150-Z02  
Kesme Hesabı : S 271 / Cutting Calculation : P 271

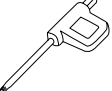

Takım Kodu Ordering Code	Stok Stock	Takım Ölçüleri (mm) Dimension (mm)						Kesici Uç Insert	Yedek Parçaları Spare Parts	
		D	Z	d	L	l	a		Sıkma Vidası Screw	Tork Anahtar Torx Key
AEM90-ZC1003-D16-C14-L150-Z02	●	16	2	14	150	25	9			
AEM90-ZC1003-D16-C14-L200-Z02	●	16	2	14	200	25	9			
AEM90-ZC1003-D16-C15-L150-Z02	●	16	2	15	150	25	9			
AEM90-ZC1003-D16-C16-L150-Z02	●	16	2	16	150	25	9			
AEM90-ZC1003-D17-C16-L150-Z02	●	17	2	16	150	25	9			
AEM90-ZC1003-D17-C16-L200-Z02	●	17	2	16	200	25	9			
AEM90-ZC1003-D20-C18-L150-Z03	●	20	3	18	150	25	9			
AEM90-ZC1003-D20-C18-L200-Z02	●	20	2	18	200	25	9			
AEM90-ZC1003-D20-C20-L150-Z03	●	20	3	20	150	40	9			
AEM90-ZC1003-D20-C18-L200-Z03	●	20	3	18	200	25	9			
AEM90-ZC1003-D21-C20-L150-Z03	●	21	3	20	150	30	9			
AEM90-ZC1003-D21-C20-L200-Z03	●	21	3	20	200	30	9			
AEM90-ZC1003-D25-C20-L150-Z03	●	25	3	20	150	30	9			
AEM90-ZC1003-D25-C20-L200-Z03	●	25	3	20	200	30	9			
AEM90-ZC1003-D25-C25-L150-Z03	●	25	3	25	150	40	9			
AEM90-ZC1003-D26-C25-L170-Z03	●	26	3	25	170	25	9			
AEM90-ZC1003-D26-C25-L200-Z03	●	26	3	25	200	25	9			
AEM90-ZC1003-D32-C25-L180-Z04	●	32	4	25	180	30	9			
AEM90-ZC1003-D33-C32-L200-Z04	●	33	4	32	200	25	9			

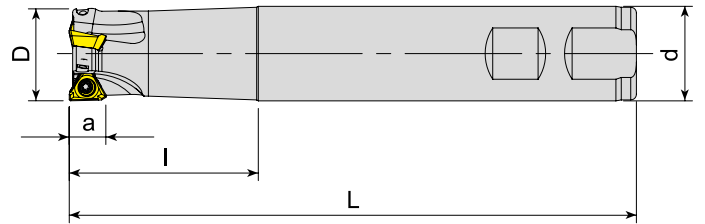
DJT Ucuna Uygundur. / Compatible with DJT Insert.



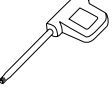



Takım Kodu Ordering Code	Stok Stock	Takım Ölçüleri (mm) Dimension (mm)						Kesici Uç Insert	Yedek Parçaları Spare Parts	
		D	Z	d	L	l	a		Sıkma Vidası Screw	Tork Anahtar Torx Key
AEM90-3P1004-D20-W20-L150-Z02	●	20	2	20	150	40	7			
AEM90-3P1004-D25-W25-L150-Z03	●	25	3	25	150	40	7			
AEM90-3P1505-D32-W32-L150-Z03	●	32	3	32	150	50	11			
AEM90-3P1505-D40-W32-L150-Z04	●	40	4	32	150	35	11			

R: Sağ/Right L: Sol/Left ● Stokta/In Stock ○ Stokta Yok/Non Stock Item  
TGTC Ucuna Uygundur. / Compatible with TGTC Insert.

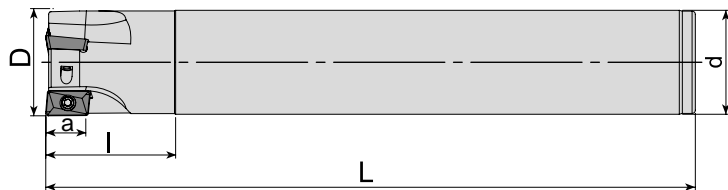
Sipariş Örneği/Ordering Example : 1 ad./pcs. AEM90-ZC1003-D16-C14-L150-Z02  
Kesme Hesabı : S 271 / Cutting Calculation : P 271





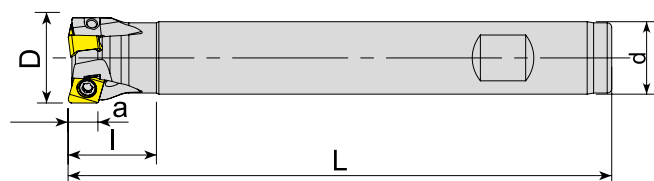

Takım Kodu Ordering Code	Stok Stock	Takım Ölçüleri (mm) Dimension (mm)						Kesici Uç Insert	Yedek Parçaları Spare Parts	
		D	Z	d	L	l	a		Sıkma Vidası Screw	Tork Anahtar Torx Key
AEM90-ZP13T3-D26-C25-L200-Z02	●	26	2	25	200	35	13			
AEM90-ZP13T3-D26-C25-L200-Z03	●	26	3	25	200	35	13			
AEM90-ZP13T3-D26-C25-L250-Z02	●	26	2	25	250	35	13			
AEM90-ZP13T3-D33-C32-L200-Z03	●	33	3	32	200	40	13			
AEM90-ZP13T3-D33-C32-L250-Z03	●	33	3	32	250	40	13			

DJT Ucuna Uygundur. / Compatiple with DJT Insert.

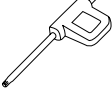

Takım Kodu Ordering Code	Stok Stock	Takım Ölçüleri (mm) Dimension (mm)						Kesici Uç Insert	Yedek Parçaları Spare Parts	
		D	Z	d	L	l	a		Sıkma Vidası Screw	Tork Anahtar Torx Key
AEM90-4N06-D16-W16-L120-Z02-H	●	16	2	16	120	25	6			
AEM90-4N06-D16-W16-L160-Z02	●	16	2	16	160	25	6			
AEM90-4N06-D20-W16-L120-Z03-H	●	20	3	16	120	20	6			
AEM90-4N06-D20-W16-L160-Z03	●	20	3	16	160	20	6			

R: Sağ/Right L: Sol/Left ● Stokta/In Stock ○ Stokta Yok/Non Stock Item  
TGTC Ucuna Uygundur. / Compatiple with TGTC Insert.

Sipariş Örneği/Ordering Example : 1 ad./pcs. AEM90-ZP13T3-D26-C25-L200-Z02  
Kesme Hesabı : S 271 / Cutting Calculation : P 271

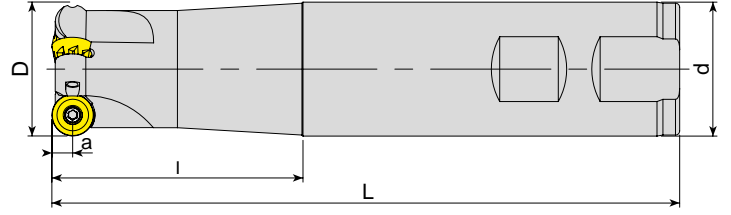

Takım Kodu Ordering Code	Stok Stock	Takım Ölçüleri (mm) Dimension (mm)						Kesici Uç Insert	Yedek Parçaları Spare Parts			
		D	Z	d	L	l	a		Sıkma Vidası Screw	Baskı Parçası Wedge Clamp	Baskı Vidası Clamp Screw	Tork Anahtar Torx Key
AEMR-RP10T3-D25-W25-L150-Z02	●	25	2	25	150	60	5	RPNX 10T3..	4010-M3x8	-	-	80-T10
AEMR-RP10T3-D32-W32-L150-Z03	●	32	3	32	150	60	5					

CRTZT Ucuna Uygundur. / Compatible with CRTZT Insert.

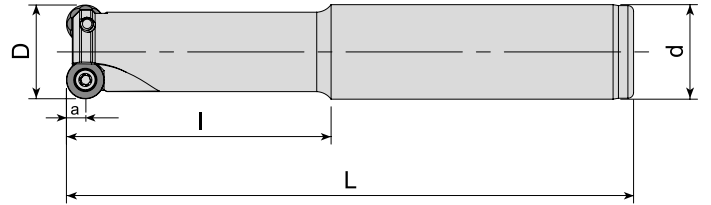

Takım Kodu Ordering Code	Stok Stock	Takım Ölçüleri (mm) Dimension (mm)						Kesici Uç Insert	Yedek Parçaları Spare Parts			
		D	Z	d	L	l	a		Sıkma Vidası Screw	Baskı Parçası Wedge Clamp	Baskı Vidası Clamp Screw	Tork Anahtar Torx Key
AEMR-QP10T3-D20-C20-L150-Z01-H	●	20	1	20	150	70	5	QP.. 10T3..	4015-M3.5x9	-	-	80-T15
AEMR-QP10T3-D25-C25-L120-Z02-H	●	25	2	25	120	40	5					
AEMR-QP10T3-D25-C25-L150-Z02-H	●	25	2	25	150	70	5					
AEMR-QP10T3-D25-C25-L170-Z02	●	25	2	25	170	90	5					
AEMR-QP10T3-D32-C32-L150-Z03-H	●	32	3	32	150	70	5					
AEMR-QP10T3-D32-C32-L170-Z03	●	32	3	32	170	90	5					
AEMR-QP1204-D25-C25-L150-Z02-H	●	25	2	25	150	70	6	QP.. 1204..	1515-M4x9	-	-	

R: Sağ/Right L: Sol/Left ● Stokta/In Stock ○ Stokta Yok/Non Stock Item  
SMTM Ucuna Uygundur. / Compatible with SMTM Insert.

Sipariş Örneği/Ordering Example : 1 ad./pcs. AEMR-RP10T3-D25-W25-L150-Z02  
Kesme Hesabı : S 271 / Cutting Calculation : P 271

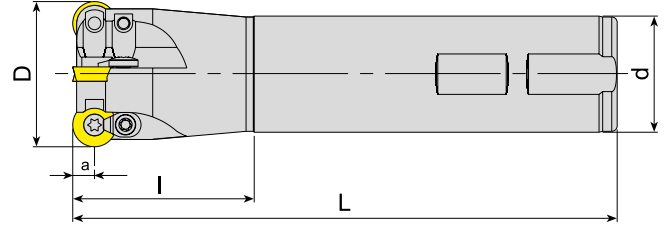

Takım Kodu Ordering Code	Stok Stock	Takım Ölçüleri (mm) Dimension (mm)					Kesici Uç Insert	Yedek Parçaları Spare Parts				
		D	Z	d	L	l		a	Sıkma Vidası Screw	Baskı Parçası Wedge Clamp	Baskı Vidası Clamp Screw	Tork Anahtar Torx Key
AEMR-RD0501-D08-W10-L100-Z01-H	●	8	1	10	100	20	2.5	RD.. 0501	3006-M2x3.6			80-T06
AEMR-RD0501-D10-W12-L100-Z02-H	●	10	2	12	100	20	2.5		3006-M2x4			
AEMR-RD0501-D12-W12-L120-Z02-H	●	12	2	12	120	20	2.5					
AEMR-RD0803-D16-W16-L150-Z02	●	16	2	16	150	60	4	RD.. 0803	1008-M3x6	-	-	80-T08
AEMR-RD0803-D16-C20-L200-Z02	●	16	2	20	200	60	4					
AEMR-RD08T2-D16-W16-L150-Z02	●	16	2	16	150	60	4	RD.. 08T2	3008-M2.5x6			
AEMR-RD08T2-D20-W20-L150-Z02	●	20	2	20	150	60	4					
AEMRC-RD1003-D20-W20-L150-Z02	●	20	2	20	150	60	5	RD.. 1003	4015-M3.5x9	ACK-15	1015-M3.5x11	80-T15
AEMRC-RD1003-D20-C20-L160-Z02	●	20	2	20	160	70	5					
AEMRC-RD1003-D20-C20-L250-Z02	●	20	2	20	250	150	5					
AEMRC-RD1003-D21-C20-L160-Z02	●	21	2	20	160	70	5					
AEMRC-RD1003-D25-W25-L150-Z02	●	25	2	25	150	60	5					
AEMRC-RD1003-D25-C25-L160-Z02	●	25	2	25	160	70	5					
AEMRC-RD1003-D25-W25-L200-Z02	●	25	2	25	200	100	5					
AEMRC-RD1003-D25-C25-L200-Z02	●	25	2	25	200	100	5					
AEMRC-RD1003-D25-C25-L250-Z02	●	25	2	25	250	150	5					
AEMRC-RD1003-D26-C25-L160-Z02	●	26	2	25	160	70	5					
AEMRC-RD1003-D32-W32-L150-Z03	●	32	3	32	150	60	5					
AEMRC-RD1003-D32-C32-L250-Z02	●	32	2	32	250	150	5					
AEMRC-RD1003-D33-C32-L160-Z03	●	33	3	32	160	70	5					
AEMRC-RD1003-D40-W32-L150-Z04	●	40	4	32	150	35	5					
AEMRC-RD1003-D40-C32-L250-Z02	●	40	2	32	250	35	5					
AEMRC-RD10T3-D20-W20-L150-Z02	●	20	2	20	150	60	5	RD.. 10T3				
AEMRC-RD10T3-D25-W25-L150-Z02	●	25	2	25	150	60	5					
AEMRC-RD10T3-D32-W32-L150-Z03	●	32	3	32	150	60	5					
AEMRC-RD1204-D32-C32-L160-Z03	●	32	3	32	160	70	6	RD.. 1204				
AEMRC-RD1204-D32-W32-L160-Z03	●	32	3	32	160	50	6					
AEMRC-RD1204-D33-C32-L160-Z03	●	33	3	32	160	70	6					
AEMRC-RD12T3-D25-W25-L150-Z02	●	25	2	25	150	60	6	RD.. 12T3	1515-M4.5x11	ACK-05	1515-M4x11	
AEMRC-RD12T3-D25-W25-L200-Z02	●	25	2	25	200	100	6					
AEMRC-RD12T3-D25-C25-L250-Z02	●	25	2	25	250	150	6					
AEMRC-RD12T3-D32-W32-L150-Z03	●	32	3	32	150	60	6					
AEMRC-RD12T3-D32-C32-L250-Z02	●	32	2	32	250	150	6					
AEMRC-RD12T3-D40-W32-L150-Z04	●	40	4	32	150	50	6					
AEMRC-RD12T3-D40-C32-L250-Z02	●	40	2	32	250	50	6					
AEMRC-RD1604-D40-W32-L150-Z02	●	40	2	32	150	35	8	RD.. 1604				

R: Sağ/Right L: Sol/Left ● Stokta/In Stock ○ Stokta Yok/Non Stock Item  
ISO Ucuna Uygunudur. / Compatible with ISO Insert.

Sipariş Örneği/Ordering Example : 1 ad./pcs. AEMR-RD0501-D08-W10-L100-Z01-H  
Kesme Hesabı : S 271 / Cutting Calculation : P 271

➤ **S-SİSTEM YÜZEY ve KOPYA PARMAK FREZELER**  
S-SYSTEM FACE and COPY END MILLS

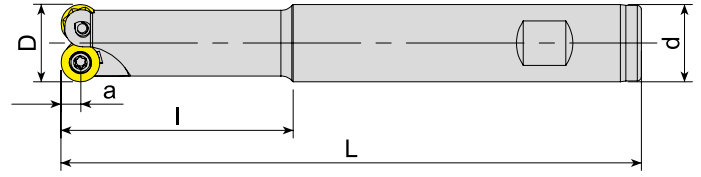

Takım Kodu Ordering Code	Stok Stock	Takım Ölçüleri (mm) Dimension (mm)						Kesici Uç Insert	Yedek Parçaları Spare Parts	
		D	Z	d	L	l	a		Sıkma Vidası Screw	Tork Anahtar Torx Key
AEMR-RY08-D16-W16-L150-Z02	●	16	2	16	150	55	4		4010-M3x6	80-T10
AEMR-RY10-D20-W20-L150-Z02	●	20	2	20	150	60	5		4015-M3.5x8	80-T15
AEMR-RY10-D20-C20-L200-Z02	●	20	2	20	200	100	5			
AEMR-RY10-D25-W25-L150-Z02	●	25	2	25	150	60	5			

TGTC Ucuna Uygundur. / Compatiple with TGTC Insert.

➤ **S-SİSTEM HIZLI İLERLEMELİ PARMAK FREZELER**  
S-SYSTEM HIGHFEED END MILLS

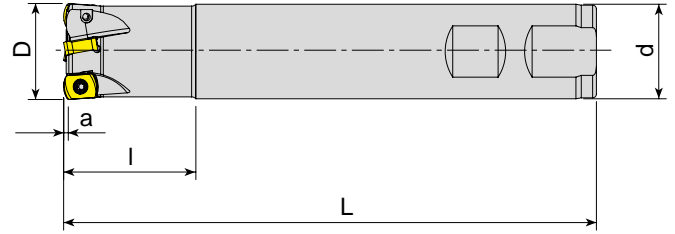



Takım Kodu Ordering Code	Stok Stock	Takım Ölçüleri (mm) Dimension (mm)						Kesici Uç Insert	Yedek Parçaları Spare Parts	
		D	Z	d	L	l	a		Sıkma Vidası Screw	Tork Anahtar Torx Key
AHFM-BL0603-D17-W16-L170-Z02	●	17	2	16	170	20	1		3008-M2.5x6	80-T08
AHFM-BL0603-D18-W16-L150-Z02-H	●	18	2	16	150	20	1			
AHFM-BL0603-D21-W20-L200-Z03	●	21	3	20	200	25	1			
AHFM-BL0603-D26-W25-L200-Z04	●	26	4	25	200	35	1			

R: Sağ/Right L: Sol/Left ● Stokta/In Stock ○ Stokta Yok/Non Stock Item  
TGTC Ucuna Uygundur. / Compatiple with TGTC Insert.

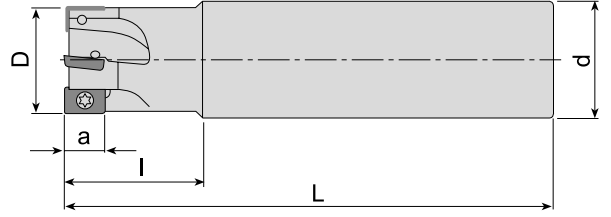

S parış Örneği/Ordering Example : 1 ad./pcs. AEMR-RY08-D16-W16-L150-Z02  
Kesme Hesabı : S 271 / Cutting Calculation : P 271

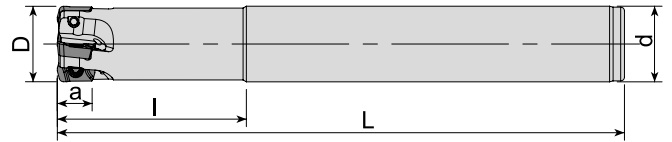

Takım Kodu Ordering Code	Stok Stock	Takım Ölçüleri (mm) Dimension (mm)						Kesici Uç Insert	Yedek Parçaları Spare Parts	
		D	Z	d	L	l	a		Sıkma Vidası Screw	Tork Anahtar Torx Key
AHFM-E00602-D10-C10-L080-Z02	●	10	2	10	80	20	-	 EO.. 0602.. ZOMT 0602..	 3006-M1.8x4	 80-T06
AHFM-E00602-D10-C09-L120-Z02	●	10	2	9	120	15	-			
AHFM-E00602-D10-C10-L120-Z02	●	10	2	10	120	60	-			
AHFM-E00602-D12-C12-L080-Z02	●	12	2	12	80	20	-			
AHFM-E00602-D12-C12-L080-Z03	●	12	3	12	80	20	-			
AHFM-E00602-D12-C11-L120-Z02	●	12	2	11	120	15	-			
AHFM-E00602-D12-C11-L120-Z03	●	12	3	11	120	15	-			
AHFM-E00602-D12-C12-L120-Z02	●	12	2	12	120	60	-			
AHFM-E00602-D12-C12-L120-Z03	●	12	3	12	120	60	-			
AHFM-E00602-D16-C16-L150-Z04	●	16	4	16	150	60	-			

DJT Ucuna Uygundur. / Compatible with DJT Insert.



Takım Kodu Ordering Code	Stok Stock	Takım Ölçüleri (mm) Dimension (mm)						Kesici Uç Insert	Yedek Parçaları Spare Parts	
		D	Z	d	L	l	a		Sıkma Vidası Screw	Tork Anahtar Torx Key
AHFM-EP1003-D16-C16-L150-Z02-H	●	16	2	16	150	50	1	 EP.. 1003.. ZPMT 1003.. YPHW 1003..	 3008-M2.5x5.5	 80-T08
AHFM-EP1003-D17-C16-L150-Z02-H	●	17	2	16	150	20	1			
AHFM-EP1003-D20-C20-L150-Z04-H	●	20	4	20	150	50	1			
AHFM-EP1003-D21-C20-L150-Z04-H	●	21	4	20	150	20	1			

R: Sağ/Right L: Sol/Left ● Stokta/In Stock ○ Stokta Yok/Non Stock Item  
DJT Ucuna Uygundur. / Compatible with DJT Insert.

Sipariş Örneği/Ordering Example : 1 ad./pcs. AHFM-E00602-D10-C10-L080-Z02  
Kesme Hesabı : S 271 / Cutting Calculation : P 271

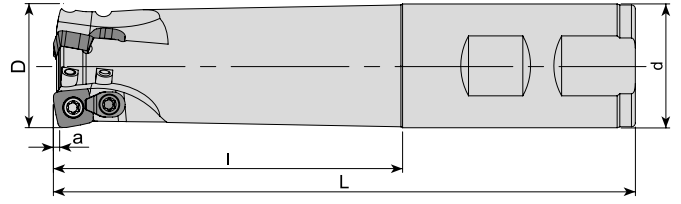

Takım Kodu Ordering Code	Stok Stock	Takım Ölçüleri (mm) Dimension (mm)						Kesici Uç Insert	Yedek Parçaları Spare Parts			
		D	Z	d	L	l	a		Sıkma Vidası Screw	Baskı Parçası Wedge Clamp	Baskı Vidası Clamp Screw	Tork Anahtar Torx Key
AHFMC-SD09T3-D25-C25-L150-Z02	●	25	2	25	150	100	1.4	SD.. 09T3..				
AHFMC-SD09T3-D25-W25-L150-Z02	●	25	2	25	150	100	1.4					
AHFMC-SD09T3-D32-C32-L150-Z03	●	32	3	32	150	100	1.4					
AHFMC-SD09T3-D32-W32-L150-Z03	●	32	3	32	150	100	1.4					

ZCC Ucuna Uygunudur. / Compatible with ZCC Insert.

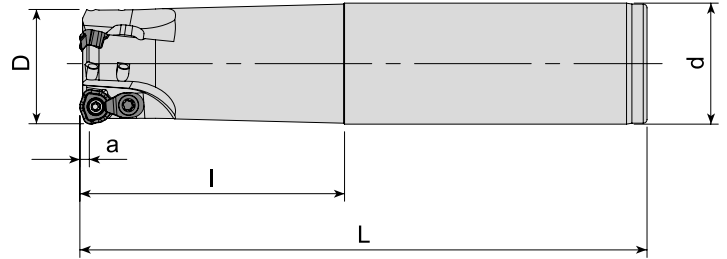

Takım Kodu Ordering Code	Stok Stock	Takım Ölçüleri (mm) Dimension (mm)						Kesici Uç Insert	Yedek Parçaları Spare Parts			
		D	Z	d	L	l	a		Sıkma Vidası Screw	Baskı Parçası Wedge Clamp	Baskı Vidası Clamp Screw	Tork Anahtar Torx Key
AHFM-WD0603-D16-C16-L150-Z02	●	16	2	16	150	70	2	WDMT 0603..				
AHFM-WD0603-D20-C20-L150-Z03	●	20	3	20	150	70	2					
AHFMC-WD0804-D25-C25-L150-Z02	●	25	2	25	150	70	2.5	WDMT 0804..				
AHFMC-WD0804-D32-C32-L150-Z03	●	32	3	32	150	70	2.5					
AHFMC-WD1205-D32-C32-L150-Z02	●	32	2	32	150	70	3	WDMT 1205..				

R: Sağ/Right L: Sol/Left ● Stokta/In Stock ○ Stokta Yok/Non Stock Item  
SMTM Ucuna Uygunudur. / Compatible with SMTM Insert.

Sipariş Örneği/Ordering Example : 1 ad./pcs. AHFMC-SD09T3-D25-C25-L150-Z02  
Kesme Hesabı : S 271 / Cutting Calculation : P 271

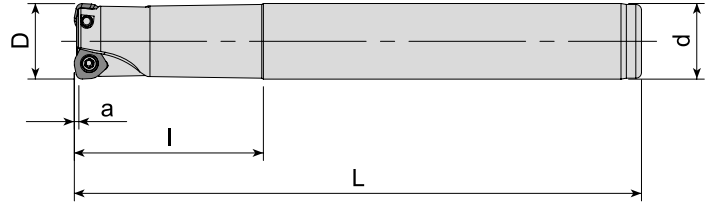

Takım Kodu Ordering Code	Stok Stock	Takım Ölçüleri (mm) Dimension (mm)						Kesici Uç Insert	Yedek Parçaları Spare Parts			
		D	Z	d	L	l	a		Sıkma Vidası Screw	Baskı Parçası Wedge Clamp	Baskı Vidası Clamp Screw	Tork Anahtar Torx Key
AHFM-WD0503D-D20-C20-L150-Z02	●	20	2	20	150	50	1.25	WD.W 0503..	4010-M3x6	-	-	80-T10
AHFM-WD0503D-D21-C20-L150-Z02	●	21	2	20	150	30	1.25					
AHFMC-WD06T3D-D26-C25-L200-Z02	●	26	2	25	200	30	1.5	WD.W 06T3..	3015-M3.5x9	ACK-15	1015-M3.5x11	80-T15
AHFMC-WD06T3D-D33-C32-L200-Z03	●	33	3	32	200	32	1.5					

DJT Ucuna Uygundur. / Compatible with DJT Insert.

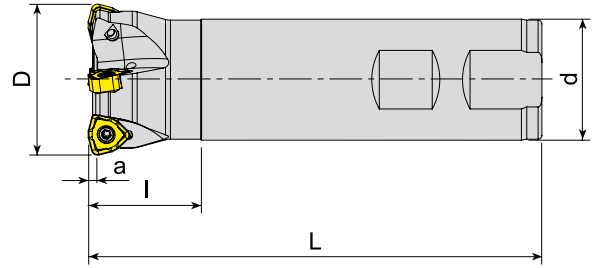





Takım Kodu Ordering Code	Stok Stock	Takım Ölçüleri (mm) Dimension (mm)						Kesici Uç Insert	Yedek Parçaları Spare Parts	
		D	Z	d	L	l	a		Sıkma Vidası Screw	Tork Anahtar Torx Key
AHFM-WN09T3-D25-W25-L120-Z02-H	●	25	2	25	120	40	1.5	WNMX 09T3..	4010-M3x8	80-T10
AHFML-WN09T3-D25-W25-L120-Z02-H	●	25	2	25	120	40	1.5			
AHFM-WN09T3-D25-C25-L200-Z02	●	25	2	25	200	120	1.5			
AHFM-WN09T3-D32-W32-L120-Z03-H	●	32	3	32	120	30	1.5			
AHFM-WN09T3-D40-W32-L120-Z04-H	●	40	4	32	120	30	1.5			
AHFM-WN09T3-D40-C32-L200-Z04	●	40	4	32	200	30	1.5			

R: Sağ/Right L: Sol/Left ● Stokta/In Stock ○ Stokta Yok/Non Stock Item  
KRLY Ucuna Uygundur. / Compatible with KRLY Insert.

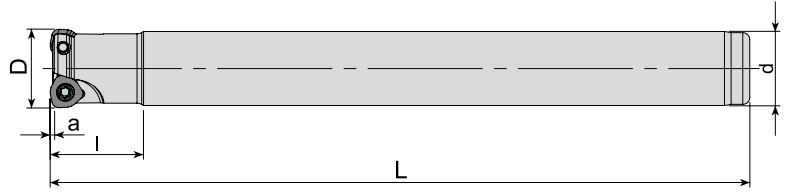
Sipariş Örneği/Ordering Example : 1 ad./pcs. AHFM-WD0503D-D20-C20-L150-Z02  
Kesme Hesabı : S 271 / Cutting Calculation : P 271

> S-SİSTEM HIZLI İLERLEMELİ PARMAK FREZELER  
S-SYSTEM HIGHFEED END MILLS



Takım Kodu Ordering Code	Stok Stock	Takım Ölçüleri (mm) Dimension (mm)						Kesici Uç Insert	Yedek Parçaları Spare Parts	
		D	Z	d	L	l	a		Sıkma Vidası Screw	Tork Anahtar Torx Key
AHFM-W004T2D-D16-C16-L150-Z02	●	16	2	16	150	20	0.8			
AHFM-W004T2D-D17-C16-L150-Z02	●	17	2	16	150	20	0.8			



DJT Ucuna Uygunur. / Compatiple with DJT Insert.

> S-SİSTEM MODÜLER PARMAK FREZELER  
S-SYSTEM MODULAR END MILLS (SCREW TYPE TOOLS)

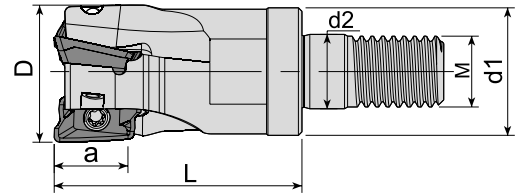

90°



Takım Kodu Ordering Code	Stok Stock	Takım Ölçüleri (mm) Dimension (mm)							Kesici Uç Insert	Yedek Parçaları Spare Parts	
		D	Z	d1	M	L	d2	a		Sıkma Vidası Screw	Tork Anahtar Torx Key
AEM90-A01236-D16-M08-L30-Z02	●	16	2	14.8	M08	30	8.5	12			
AEM90-A01236-D20-M10-L35-Z03	●	20	3	18	M10	35	10.5	12			

R: Sağ/Right L: Sol/Left ● Stokta/In Stock ○ Stokta Yok/Non Stock Item  
MTSBH Ucuna Uygunur. / Compatiple with MTSBH Insert.

Sipariş Örneği/Ordering Example : 1 ad./pcs. AHFM-W004T2D-D16-C16-L150-Z02  
Kesme Hesabı : S 271 / Cutting Calculation : P 271  
Sıkma Tork Değeri : S 271 / Tightening Torque : P 271



www.akkо.com.tr

Дистрибьютер ООО "Ресурс Плюс"  
+7 (351) 247-74-40; info@rp-ural.ru



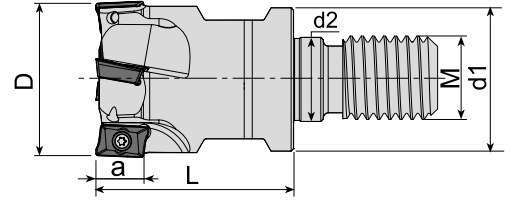

Takım Kodu Ordering Code	Stok Stock	Takım Ölçüleri (mm) Dimension (mm)							Kesici Uç Insert	Yedek Parçaları Spare Parts	
		D	Z	d1	M	L	d2	a		Sıkma Vidası Screw	Tork Anahtar Torx Key
AEM90-AD1505D-D25-M12-L43-Z02-H	●	25	2	21	M12	43	12.5	14.3	ADKT 150508	1515-M4x9	80-T15
AEM90-AD1505D-D32-M16-L43-Z03-H	●	32	3	29	M16	43	17	14.3		1515-M4x11	

DJT Ucuna Uygundur. / Compatible with DJT Insert.

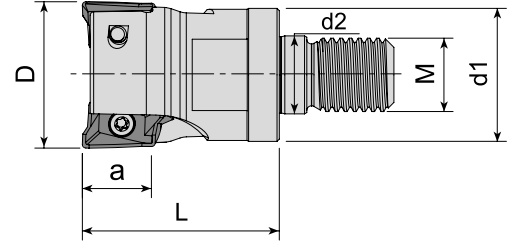







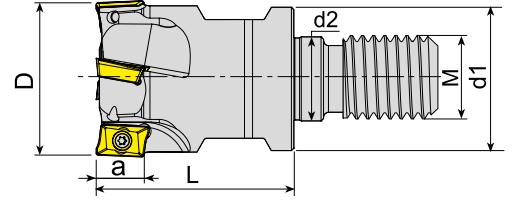



Takım Kodu Ordering Code	Stok Stock	Takım Ölçüleri (mm) Dimension (mm)							Kesici Uç Insert	Yedek Parçaları Spare Parts	
		D	Z	d1	M	L	d2	a		Sıkma Vidası Screw	Tork Anahtar Torx Key
AEM90-AX1235-D16-M08-L30-Z02-H	●	16	2	14.75	M08	30	8.5	10	AX.T 1235..	1008-M3x6	80-T08
AEM90-AX1235-D20-M10-L30-Z03-H	●	20	3	18	M10	30	10.5	10		1515-M4x9	
AEM90-AX1235-D25-M12-L35-Z04-H	●	25	4	21	M12	35	12.5	10	AX.T 1705..	1515-M4x9	80-T15
AEM90-AX1705-D25-M12-L43-Z02-H	●	25	2	21	M12	43	12.5	14			
AEM90-AX1705-D32-M16-L43-Z02-H	●	32	2	29	M16	43	17	14			

R: Sağ/Right L: Sol/Left ● Stokta/In Stock ○ Stokta Yok/Non Stock Item  
SMTM Ucuna Uygundur. / Compatible with SMTM Insert.

Sipariş Örneği/Ordering Example : 1 ad./pcs. AEM90-AD1505D-D25-M12-L43-Z02-H  
Kesme Hesabı : S 271 / Cutting Calculation : P 271  
Sıkma Tork Değeri : S 271 / Tightening Torque : P 271



Takım Kodu Ordering Code	Stok Stock	Takım Ölçüleri (mm) Dimension (mm)							Kesici Uç Insert	Yedek Parçaları Spare Parts	
		D	Z	d1	M	L	d2	a		Sıkma Vidası Screw	Tork Anahtar Torx Key
AEM90-AP10-D16-M08-L30-Z02-H	●	16	2	14.75	M08	30	8.5	10	 <b>AP.. 1003..</b> ISO UCUNA UYGUNDUR. FOR ISO INSERT.	 3008-M2.5x6	 80-T08
AEM90-AP10-D20-M10-L30-Z03-H	●	20	3	18	M10	30	10.5	10			
AEM90-AP10-D25-M12-L35-Z03-H	●	25	3	21	M12	35	12.5	10			
AEM90-AP10-D32-M16-L35-Z04-H	●	32	4	29	M16	35	17	10			
AEM90-AP10-D40-M16-L43-Z05-H	●	40	5	29	M16	43	17	10			
AEM90-AP10-D42-M16-L43-Z05-H	●	42	5	29	M16	43	17	10			
AEM90-AP10D-D16-M08-L30-Z02-H	●	16	2	14.75	M08	30	8.5	10	 <b>AP.. 1003..</b> DJT UCUNA UYGUNDUR. FOR DJT INSERT.	3008-M2.5x6	80-T08
AEM90-AP10D-D20-M10-L30-Z03-H	●	20	3	18	M10	30	10.5	10			
AEM90-AP10D-D25-M12-L35-Z03-H	●	25	3	21	M12	35	12.5	10			
AEM90-AP11-D16-M08-L30-Z02-H	●	16	2	14.75	M08	30	8.5	11	 <b>AP.. 11T3..</b> ZCC UCUNA UYGUNDUR. FOR ZCC INSERT.	3008-M2.5x6	80-T08
AEM90-AP11-D20-M10-L30-Z03-H	●	20	3	18	M10	30	10.5	11			
AEM90-AP11-D25-M12-L35-Z03-H	●	25	3	21	M12	35	12.5	11			
AEM90-AP11-D32-M16-L35-Z04-H	●	32	4	29	M16	35	17	11			
AEM90-AP11-D40-M16-L43-Z05-H	●	40	5	29	M16	43	17	11	 <b>AP.. 1604..</b> ISO UCUNA UYGUNDUR. FOR ISO INSERT.	1515-M4x9	80-T15
AEM90-AP16-D25-M12-L43-Z02-H	●	25	2	21	M12	43	12.5	16			
AEM90-AP16-D32-M16-L43-Z03-H	●	32	3	29	M16	43	17	16			
AEM90-AP16-D40-M16-L43-Z04-H	●	40	4	29	M16	43	17	16			
AEM90-AP16D-D25-M12-L43-Z02-H	●	25	2	21	M12	43	12.5	16			
AEM90-AP16D-D32-M16-L43-Z03-H	●	32	3	29	M16	43	17	16			
AEM90-AP16D-D40-M16-L43-Z04-H	●	40	4	29	M16	43	17	16	 <b>AP.. 1604..</b> DJT UCUNA UYGUNDUR. FOR DJT INSERT.	1515-M4x9	80-T15
AEM90-AP16L-D25-M12-L43-Z02-H	●	25	2	21	M12	43	12.5	16			
AEM90-AP16L-D32-M16-L43-Z03-H	●	32	3	29	M16	43	17	16			
AEM90-AP16L-D40-M16-L43-Z04-H	●	40	4	29	M16	43	17	16	 <b>AP.. 1604..</b> LMN UCUNA UYGUNDUR. FOR LMN INSERT.	1515-M4x9	80-T15
AEM90-AP16L-D32-M16-L43-Z03-H	●	32	3	29	M16	43	17	16			
AEM90-AP16L-D40-M16-L43-Z04-H	●	40	4	29	M16	43	17	16	 <b>AP.. 1604..</b> LMN UCUNA UYGUNDUR. FOR LMN INSERT.	1515-M4x9	80-T15
AEM90-AP16L-D32-M16-L43-Z03-H	●	32	3	29	M16	43	17	16			
AEM90-AP16L-D40-M16-L43-Z04-H	●	40	4	29	M16	43	17	16	 <b>AP.. 1604..</b> LMN UCUNA UYGUNDUR. FOR LMN INSERT.	1515-M4x9	80-T15
AEM90-AP16L-D32-M16-L43-Z03-H	●	32	3	29	M16	43	17	16			

R: Sağ/Right L: Sol/Left ● Stokta/In Stock ○ Stokta Yok/Non Stock Item

Sipariş Örneği/Ordering Example : 1 ad./pcs. AEM90-AP10-D16-M08-L30-Z02-H

Kesme Hesabı : S 271 / Cutting Calculation : P 271

Sıkma Tork Değeri : S 271 / Tightening Torque : P 271



90°

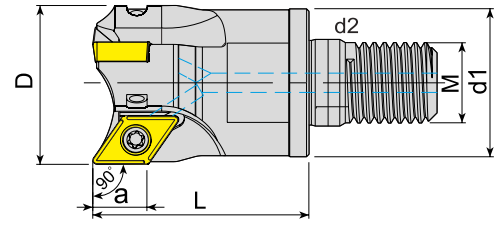

Takım Kodu Ordering Code	Stok Stock	Takım Ölçüleri (mm) Dimension (mm)							Kesici Uç Insert	Yedek Parçaları Spare Parts	
		D	Z	d1	M	L	d2	a		Sıkma Vidası Screw	Tork Anahtar Torx Key
AEM90-DC07-D20-M10-L30-Z02-H	●	20	2	18	M10	30	10.5	7	DC.T 0702.		
AEM90-DC07-D25-M12-L35-Z03-H	●	25	3	21	M12	35	12.5	7			
AEM90-DC07-D32-M16-L43-Z04-H	●	32	4	29	M16	43	17	7			
AEM90-DC07-D40-M16-L43-Z05-H	●	40	5	29	M16	43	17	7			
AEM90-DC11-D32-M16-L43-Z03-H-F	●	32	3	29	M16	43	17	11	DC.T 11T3..	4015-M3.5x9	80-T15
AEM90-DC11-D40-M16-L43-Z03-H-F	●	40	3	29	M16	43	17	11			

F: Çap toleransı +, - 0,02 mm içerisinde anlamına gelmektedir. / F: Diameter tolerance is between +, - 0,02 mm.  
ISO Ucuna Uygunudur. / Compatible with ISO Insert.

90°

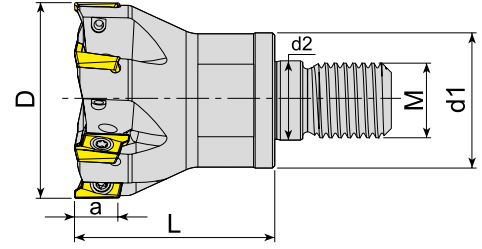

Takım Kodu Ordering Code	Stok Stock	Takım Ölçüleri (mm) Dimension (mm)							Kesici Uç Insert	Yedek Parçaları Spare Parts	
		D	Z	d1	M	L	d2	a		Sıkma Vidası Screw	Tork Anahtar Torx Key
AEM90-RT10-D16-M08-L20-Z02-H	●	16	2	14.75	M08	20	8.5	10	RT 1003..		
AEM90-RT10-D20-M10-L25-Z03-H	●	20	3	18	M10	25	10.5	10			
AEM90-RT10-D25-M12-L30-Z04-H	●	25	4	21	M12	30	12.5	10			
AEM90-RT10-D32-M16-L43-Z05-H	●	32	5	29	M16	43	17	10			
AEM90-RT10-D42-M16-L43-Z06-H	●	42	6	29	M16	43	17	10			

R: Sağ/Right L: Sol/Left ● Stokta/In Stock ○ Stokta Yok/Non Stock Item  
SFTY Ucuna Uygunudur. / Compatible with SFTY Insert.

Sipariş Örneği/Ordering Example : 1 ad./pcs. AEM90-DC07-D20-M10-L30-Z02-H  
Kesme Hesabı : S 271 / Cutting Calculation : P 271  
Sıkma Tork Değeri : S 271 / Tightening Torque : P 271

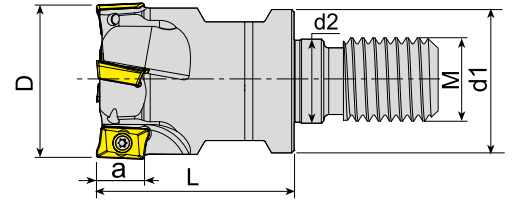

Takım Kodu Ordering Code	Stok Stock	Takım Ölçüleri (mm) Dimension (mm)							Kesici Uç Insert	Yedek Parçaları Spare Parts		
		D	Z	d1	M	L	d2	a		Sıkma Vidası Screw	Tork Anahtar Torx Key	
AEM90-R390.11-D16-M08-L30-Z02-H	●	16	2	14.75	M08	30	8.5	10				
AEM90-R390.11-D20-M10-L30-Z03-H	●	20	3	18	M10	30	10.5	10				
AEM90-R390.11-D25-M12-L35-Z03-H	●	25	3	21	M12	35	12.5	10				
AEM90-R390.11-D32-M16-L43-Z04-H	●	32	4	29	M16	43	17	10				

SNDVK Ucuna Uygun. / Compatible with SNDVK Insert.

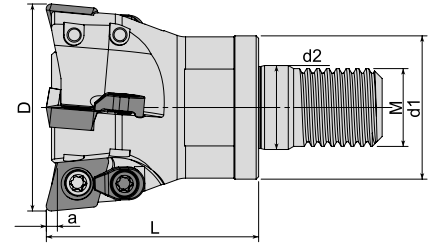

Takım Kodu Ordering Code	Stok Stock	Takım Ölçüleri (mm) Dimension (mm)							Kesici Uç Insert	Yedek Parçaları Spare Parts			
		D	Z	d1	M	L	d2	a		Sıkma Vidası Screw	Baskı Parçası Wedge Clamp	Baskı Vidası Clamp Screw	Tork Anahtar Torx Key
AEM95-XD0206-D16-M08-L23-Z02-H	●	16	2	14.75	8	23	8.5	1					
AEM95-XD0206-D16-M08-L23-Z02-H-F	●	16	2	14.75	8	23	8.5	1					
AEM95-XD0206-D20-M10-L30-Z03-H	●	20	3	18	10	30	10.5	1					
AEM95-XD0206-D20-M10-L30-Z03-H-F	●	20	3	18	10	30	10.5	1					
AEM95-XD0206-D25-M12-L35-Z03-H	●	25	3	21	12	35	12.5	1					
AEM95-XD0206-D25-M12-L35-Z03-H-F	●	25	3	21	12	35	12.5	1					
AEM95C-XD0310-D35-M16-L43-Z03-H	●	35	3	29	16	43	17	1.5					
AEM95C-XD0310-D35-M16-L43-Z03-H-F	●	35	3	29	16	43	17	1.5					
AEM95C-XD0310-D42-M16-L43-Z04-H	●	42	4	29	16	43	17	1.5					
AEM95C-XD0310-D42-M16-L43-Z04-H-F	●	42	4	29	16	43	17	1.5					

R: Sağ/Right L: Sol/Left ● Stokta/In Stock ○ Stokta Yok/Non Stock Item  
DJT Ucuna Uygun. / Compatible with DJT Insert.

F: Çap toleransı +, - 0,02 mm içerisinde anlamına gelmektedir. / F: Diameter tolerance is between +, - 0,02 mm.

Sipariş Örneği/Ordering Example : 1 ad./pcs. AEM90-R390.11-D16-M08-L30-Z02-H  
Kesme Hesabı : S 271 / Cutting Calculation : P 271  
Sıkma Tork Değeri : S 271 / Tightening Torque : P 271

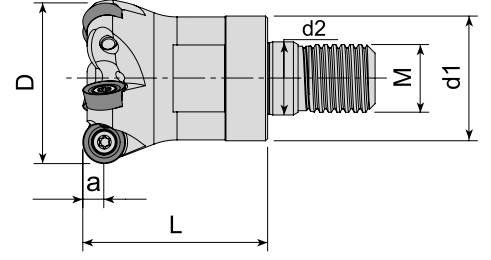

Takım Kodu Ordering Code	Stok Stock	Takım Ölçüleri (mm) Dimension (mm)							Kesici Uç Insert	Yedek Parçaları Spare Parts	
		D	Z	d1	M	L	d2	a		Sıkma Vidası Screw	Tork Anahtar Torx Key
AEMR-RC10T3-D25-M12-L35-Z03-H	●	25	3	21	M12	35	12.5	5	RC.. 10T3..	1515-M4x9	80-T15
AEMR-RC10T3-D32-M16-L43-Z04-H	●	32	4	29	M16	43	17	5			
AEMR-RC10T3-D40-M16-L43-Z05-H	●	40	5	29	M16	43	17	5			

ZCC Ucuna Uygundur. / Compatible with ZCC Insert.

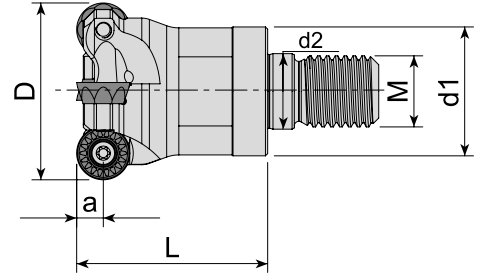

Takım Kodu Ordering Code	Stok Stock	Takım Ölçüleri (mm) Dimension (mm)							Kesici Uç Insert	Yedek Parçaları Spare Parts	
		D	Z	d1	M	L	d2	a		Sıkma Vidası Screw	Tork Anahtar Torx Key
AEMR-RP08T2M-D20-M10-L30-Z02-H	●	20	2	18	M10	30	10.5	4	RPMT 08T2..	3008-M2.5x6	80-T08
AEMR-RP10T3M-D25-M12-L35-Z02-H	●	25	2	21	M12	35	12.5	5	RPMT 10T3..	4015-M3.5x9	80-T15
AEMR-RP10T3M-D32-M16-L43-Z03-H	●	32	3	29	M16	43	17	5			
AEMR-RP1204M-D32-M16-L43-Z03-H	●	32	3	29	M16	43	17	6	RPMT 1204..	4015-M4X9	
AEMR-RP1204M-D40-M16-L43-Z04-H	●	40	4	29	M16	43	17	6			

R: Sağ/Right L: Sol/Left ● Stokta/In Stock ○ Stokta Yok/Non Stock Item  
MTSBH Ucuna Uygundur. / Compatible with MTSBH Insert.

Sipariş Örneği/Ordering Example : 1 ad./pcs. AEMR-RC10T3-D25-M12-L35-Z03-H  
Kesme Hesabı : S 271 / Cutting Calculation : P 271  
Sıkma Tork Değeri : S 271 / Tightening Torque : P 271

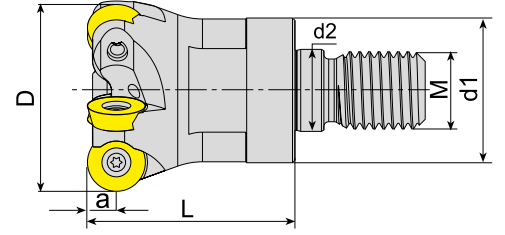

Takım Kodu Ordering Code	Stok Stock	Takım Ölçüleri (mm) Dimension (mm)							Kesici Uç Insert	Yedek Parçaları Spare Parts	
		D	Z	d1	M	L	d2	a		Sıkma Vidası Screw	Tork Anahtar Torx Key
AEMR-RD0702-D15-M08-L23-Z02-H	●	15	2	13	M08	23	8.5	3.5	RD.. 0702	3008-M2.5x6	80-T08
AEMR-RD0702-D16-M08-L23-Z02-H	●	16	2	13	M08	23	8.5	3.5			
AEMR-RD0702-D20-M10-L30-Z04-H	●	20	4	18	M10	30	10.5	3.5			
AEMR-RD0702-D25-M12-L35-Z05-H	●	25	5	21	M12	35	12.5	3.5			
AEMR-RD0702-D30-M16-L42-Z05-H	●	30	5	29	M16	42	17	3.5			
AEMR-RD0702-D32-M16-L43-Z05-H	●	32	5	29	M16	43	17	3.5			
AEMR-RD0702-D35-M16-L42-Z06-H	●	35	6	29	M16	42	17	3.5			
AEMR-RD0702-D42-M16-L43-Z05-H	●	42	5	29	M16	43	17	3.5			
AEMR-RD0702-D42-M16-L43-Z07-H	●	42	7	29	M16	43	17	3.5			
AEMR-RD08T2-D16-M08-L23-Z02-H	●	16	2	13	M08	23	8.5	4	RD.. 08T2	3008-M2.5x6	80-T08
AEMR-RD08T2-D20-M10-L30-Z03-H	●	20	3	18	M10	30	10.5	4			
AEMR-RD08T2-D25-M12-L35-Z04-H	●	25	4	21	M12	35	12.5	4			
AEMR-RD0803-D16-M08-L23-Z02-H	●	16	2	13	M08	23	8.5	4	RD.. 0803	1008-M3x6	80-T15
AEMR-RD0803-D20-M10-L30-Z03-H	●	20	3	18	M10	30	10.5	4		1008-M3x8	
AEMR-RD0803-D25-M12-L35-Z04-H	●	25	4	21	M12	35	12.5	4			
AEMR-RD1003-D20-M10-L30-Z02-H	●	20	2	18	M10	30	10.5	5	RD.. 1003	4015-M3.5x9	80-T15
AEMR-RD1003-D25-M12-L35-Z02-H	●	25	2	21	M12	35	12.5	5			
AEMR-RD1003-D25-M12-L35-Z03-H	●	25	3	21	M12	35	12.5	5			
AEMR-RD1003-D30-M16-L43-Z04-H	●	30	4	29	M16	43	17	5			
AEMR-RD1003-D32-M16-L43-Z04-H	●	32	4	29	M16	43	17	5			
AEMR-RD1003-D35-M16-L43-Z04-H	●	35	4	29	M16	43	17	5			
AEMR-RD1003-D40-M16-L43-Z05-H	●	40	5	29	M16	43	17	5			
AEMR-RD1003-D42-M16-L43-Z05-H	●	42	5	29	M16	43	17	5			
AEMR-RD12T3-D24-M12-L35-Z02-H	●	24	2	21	M12	35	12.5	6			
AEMR-RD12T3-D25-M12-L35-Z02-H	●	25	2	21	M12	35	12.5	6			
AEMR-RD12T3-D32-M16-L43-Z03-H	●	32	3	29	M16	43	17	6			
AEMR-RD12T3-D35-M16-L43-Z03-H	●	35	3	29	M16	43	17	6			
AEMR-RD12T3-D35-M16-L43-Z04-H	●	35	4	29	M16	43	17	6			
AEMR-RD12T3-D40-M16-L43-Z04-H	●	40	4	29	M16	43	17	6			
AEMR-RD12T3-D42-M16-L43-Z05-H	●	42	5	29	M16	43	17	6	RD.. 1204	4015-M3.5x9	80-T15
AEMR-RD1204-D32-M16-L43-Z03-H	●	32	3	29	M16	43	17	6			
AEMR-RD1204-D42-M16-L43-Z04-H	●	42	4	29	M16	43	17	6	RD.. 1604	1515-M4.5X11	80-T15
AEMR-RD1604-D32-M16-L43-Z02-H	●	32	2	29	M16	43	17	8			
AEMR-RD1604-D40-M16-L43-Z02-H	●	40	2	29	M16	43	17	8			
AEMR-RD1604-D42-M16-L43-Z03-H	●	42	3	29	M16	43	17	8			

R: Sağ/Right L: Sol/Left ● Stokta/In Stock ○ Stokta Yok/Non Stock Item  
ISO Ucuna Uygundur. / Compatible with ISO Insert.

Sipariş Örneği/Ordering Example : 1 ad./pcs. AEMR-RD0702-D15-M08-L23-Z02-H  
Kesme Hesabı : S 271 / Cutting Calculation : P 271  
Sıkma Tork Değeri : S 271 / Tightening Torque : P 271



www.akko.com.tr

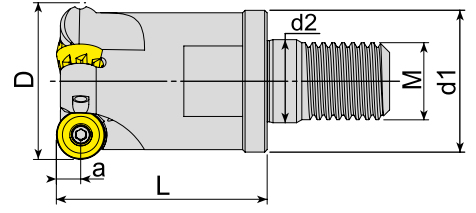

Takım Kodu Ordering Code	Stok Stock	Takım Ölçüleri (mm) Dimension (mm)							Kesici Uç Insert	Yedek Parçaları Spare Parts	
		D	Z	d1	M	L	d2	a		Sıkma Vidası Screw	Tork Anahtar Torx Key
AEMR-RP10T3-D25-M12-L35-Z02-H	●	25	2	21	12	35	12.5	5	RPNX 10T3..	4010-M3x8	80-T10
AEMR-RP10T3-D32-M16-L43-Z03-H	●	32	3	29	16	43	17	5			

CRTZT Ucuna Uygunudur. / Compatible with CRTZT Insert.

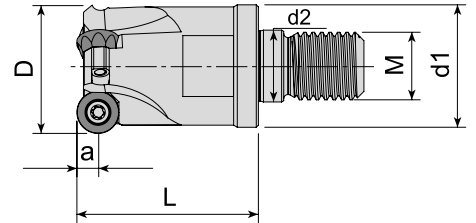

Takım Kodu Ordering Code	Stok Stock	Takım Ölçüleri (mm) Dimension (mm)							Kesici Uç Insert	Yedek Parçaları Spare Parts	
		D	Z	d1	M	L	d2	a		Sıkma Vidası Screw	Tork Anahtar Torx Key
AEMR-QP10T3-D25-M12-L35-Z02-H	●	25	2	21	M12	35	12.5	5	QP.. 10T3..	4015-M3.5x9	80-T15
AEMR-QP10T3-D32-M16-L43-Z03-H	●	32	3	29	M16	43	17	5			

R: Sağ/Right L: Sol/Left ● Stokta/In Stock ○ Stokta Yok/Non Stock Item  
SMTM Ucuna Uygunudur. / Compatible with SMTM Insert.

Sipariş Örneği/Ordering Example : 1 ad./pcs. AEMR-RP10T3-D25-M12-L35-Z02-H  
Kesme Hesabı : S 271 / Cutting Calculation : P 271  
Sıkma Tork Değeri : S 271 / Tightening Torque : P 271

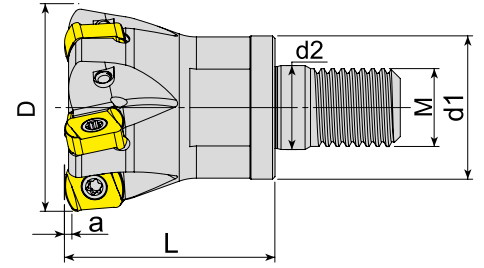

Takım Kodu Ordering Code	Stok Stock	Takım Ölçüleri (mm) Dimension (mm)							Kesici Uç Insert	Yedek Parçaları Spare Parts	
		D	Z	d1	M	L	d2	a		Sıkma Vidası Screw	Tork Anahtar Torx Key
AHFM-BL0603-D32-M16-L40-Z05-H	●	32	5	29	M16	40	17	1		3008-M2.5x6	80-T08
AHFM-BL0904-D42-M16-L43-Z05-H	●	42	5	29	M16	43	17	2		1510-M3.5x9	80-T10

TGTC Ucuna Uygunur. / Compatiple with TGTC Insert.

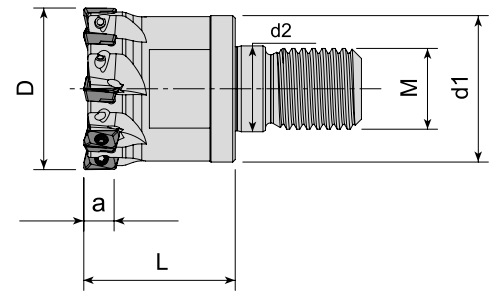



Takım Kodu Ordering Code	Stok Stock	Takım Ölçüleri (mm) Dimension (mm)							Kesici Uç Insert	Yedek Parçaları Spare Parts	
		D	Z	d1	M	L	d2	a		Sıkma Vidası Screw	Tork Anahtar Torx Key
AHFM-ED0702-D12-M06-L20-Z03	●	12	3	10	M06	20	6.5	6		3006-M1.8x4	80-T06
AHFM-ED0702-D16-M08-L25-Z04-H	●	16	4	14.75	M08	25	8.5	6			
AHFM-ED0702-D20-M10-L30-Z05-H	●	20	5	18	M10	30	10.5	6			
AHFM-ED0702-D25-M12-L30-Z06-H	●	25	6	21	M12	30	12.5	6			
AHFM-ED0702-D32-M16-L30-Z08-H	●	32	8	29	M16	30	17	6			

R: Sağ/Right L: Sol/Left ● Stokta/In Stock ○ Stokta Yok/Non Stock Item  
HTCH Ucuna Uygunur. / Compatiple with HTCH Insert.

Sipariş Örneği/Ordering Example : 1 ad./pcs. AHFM-BL0603-D32-M16-L40-Z05-H  
Kesme Hesabı : S 271 / Cutting Calculation : P 271  
Sıkma Tork Değeri : S 271 / Tightening Torque : P 271

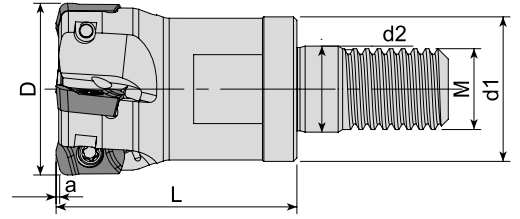



Takım Kodu Ordering Code	Stok Stock	Takım Ölçüleri (mm) Dimension (mm)							Kesici Uç Insert	Yedek Parçaları Spare Parts		
		D	Z	d1	M	L	d2	a		Sıkma Vidası Screw	Tork Anahtar Torx Key	
AHFM-EP1003-D16-M08-L23-Z02-H	●	16	2	14.75	8	23	8.5	1	 EP.. 1003.. ZPMT 1003.. YPHW 1003..	3008-M2.5x5.5	80-T08	
AHFM-EP1003-D20-M10-L30-Z04-H	●	20	4	18	10	30	10.5	1				
AHFM-EP1003-D25-M12-L35-Z04-H	●	25	4	21	12	35	12.5	1				
AHFM-EP1003-D32-M16-L43-Z05-H	●	32	5	29	16	43	17	1				
AHFM-EP1003-D35-M16-L43-Z05-H	●	35	5	29	16	43	17	1				
AHFM-EP1003-D42-M16-L43-Z06-H	●	42	6	29	16	43	17	1				

DJT Ucuna Uygundur. / Compatible with DJT Insert.

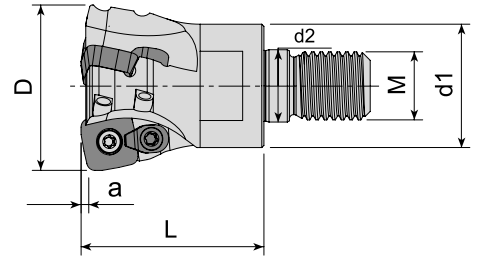

Takım Kodu Ordering Code	Stok Stock	Takım Ölçüleri (mm) Dimension (mm)							Kesici Uç Insert	Yedek Parçaları Spare Parts			
		D	Z	d1	M	L	d2	a		Sıkma Vidası Screw	Baskı Parçası Wedge Clamp	Baskı Vidası Clamp Screw	Tork Anahtar Torx Key
AHFMC-SD09T3-D22-M12-L30-Z02-H	○	22	2	21	M12	30	12.5	1.4	 SD.. 09T3..	3015-M3.5x9	ACK-15	1015-M3.5x11	80-T15
AHFMC-SD09T3-D25-M12-L30-Z02-H	●	25	2	22	M12	30	12.5	1.4					
AHFMC-SD09T3-D32-M16-L43-Z03-H	●	32	3	29	M16	43	17	1.4					
AHFMC-SD09T3-D35-M16-L43-Z03-H	●	35	3	29	M16	43	17	1.4					
AHFMC-SD09T3-D40-M16-L43-Z04-H	●	40	4	29	M16	43	17	1.4					
AHFMC-SD1204-D32-M16-L43-Z02-H	●	32	2	29	M16	43	17	1.8		1515-M4x9			
AHFMC-SD1204-D40-M16-L43-Z03-H	●	40	3	29	M16	43	17	1.8					

R: Sağ/Right L: Sol/Left ● Stokta/In Stock ○ Stokta Yok/Non Stock Item  
ZCC Ucuna Uygundur. / Compatible with ZCC Insert.

Sipariş Örneği/Ordering Example : 1 ad./pcs. AHFM-EP1003-D16-M08-L23-Z02-H  
Kesme Hesabı : S 271 / Cutting Calculation : P 271

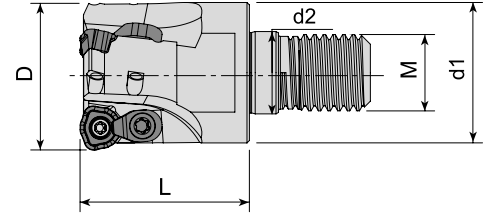

Takım Kodu Ordering Code	Stok Stock	Takım Ölçüleri (mm) Dimension (mm)							Kesici Uç Insert	Yedek Parçaları Spare Parts			
		D	Z	d1	M	L	d2	a		Sıkma Vidası Screw	Baskı Parçası Wedge Clamp	Baskı Vidası Clamp Screw	Tork Anahtar Torx Key
AHFMC-WD0804-D25-M12-L35-Z02-H	●	25	2	21	M12	35	12.5	-	WDMT 0804..	4010-M3x8	ACK-15	4010-M3x8	80-T10
AHFMC-WD0804-D32-M16-L35-Z03-H	●	32	3	29	M16	35	17	-					

SMTM Ucuna Uygundur. / Compatible with SMTM Insert.

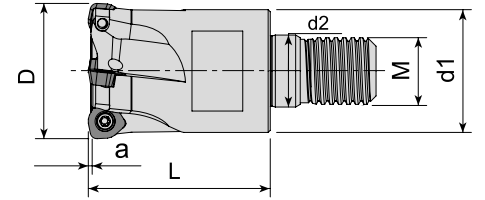

Takım Kodu Ordering Code	Stok Stock	Takım Ölçüleri (mm) Dimension (mm)							Kesici Uç Insert	Yedek Parçaları Spare Parts			
		D	Z	d1	M	L	d2	a		Sıkma Vidası Screw	Baskı Parçası Wedge Clamp	Baskı Vidası Clamp Screw	Tork Anahtar Torx Key
AHFM-WD0503D-D20-M10-L30-Z02-H	●	20	2	18	M10	30	10.5	1.25	WDMT 0503..	4010-M3x6	-	-	80-T10
AHFM-WD0503D-D25-M12-L35-Z03-H	●	25	3	21	M12	35	12.5	1.25		4010-M3x8			
AHFM-WD0503D-D32-M16-L43-Z04-H	●	32	4	29	M16	43	17	1.25					
AHFM-WD0503D-D40-M16-L43-Z05-H	●	40	5	29	M16	43	17	1.25					
AHFMC-WD06T3D-D35-M16-L43-Z03-H	●	35	3	29	M16	43	17	1.5	WDHW 06T3..	3015-M3.5x9	ACK-15	1015-M3.5x11	80-T15
AHFMC-WD0805D-D32-M16-L43-Z02-H	●	32	2	29	M16	43	17	2	WDHW 0805..	4020-M4.5x10	ACK-19	4020-M4.5x12	

R: Sağ/Right L: Sol/Left ● Stokta/In Stock ○ Stokta Yok/Non Stock Item  
DJT Ucuna Uygundur. / Compatible with DJT Insert.

Sipariş Örneği/Ordering Example : 1 ad./pcs. AHFMC-WD0804-D25-M12-L35-Z02-H  
Kesme Hesabı : S 271 / Cutting Calculation : P 271  
Sıkma Tork Değeri : S 271 / Tightening Torque : P 271

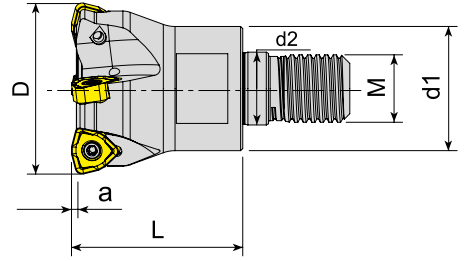

Takım Kodu Ordering Code	Stok Stock	Takım Ölçüleri (mm) Dimension (mm)							Kesici Uç Insert	Yedek Parçaları Spare Parts	
		D	Z	d1	M	L	d2	a		Sıkma Vidası Screw	Tork Anahtar Torx Key
AHFM-WN09T3-D32-M16-L40-Z03-H	●	32	3	29	M16	40	17	1.5			
AHFM-WN09T3-D40-M16-L40-Z04-H	●	40	4	29	M16	40	17	1.5			

KRLY Ucuna Uygunudur. / Compatible with KRLY Insert.

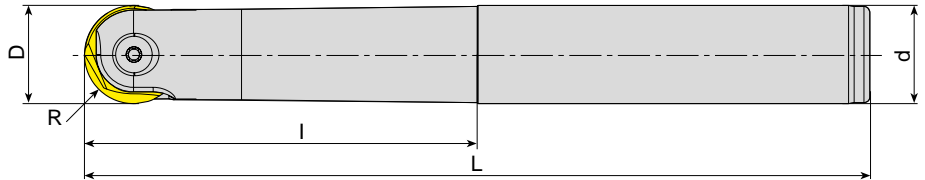

Takım Kodu Ordering Code	Stok Stock	Takım Ölçüleri (mm) Dimension (mm)					Kesici Uç Insert	Yedek Parçaları Spare Parts	
		D	R	d	L	l		Sıkma Vidası Screw	Anahtar Key
APMR-P3208-D08-C10-L110	●	8	4	10	110	25			
APMR-P3210-D10-C10-L130	●	10	5	10	130	30			
APMR-P3210-D10-C12-L130	●	10	5	12	130	30			
APMR-P3212-D12-C12-L130	●	12	6	12	130	32			
APMR-P3216-D16-C16-L175	●	16	8	16	175	60			
APMR-P3220-D20-C20-L200	●	20	10	20	200	100			
APMR-P3225-D25-C25-L200	●	25	12.5	25	200	100			
APMR-P3232-D32-C32-L200	●	32	16	32	200	100			

R: Sağ/Right L: Sol/Left ● Stokta/In Stock ○ Stokta Yok/Non Stock Item  
WLTR Ucuna Uygunudur. / Compatible with WLTR Insert.

Sipariş Örneği/Ordering Example : 1 ad./pcs. AHFM-WN09T3-D32-M16-L40-Z03-H  
Kesme Hesabı : S 271 / Cutting Calculation : P 271

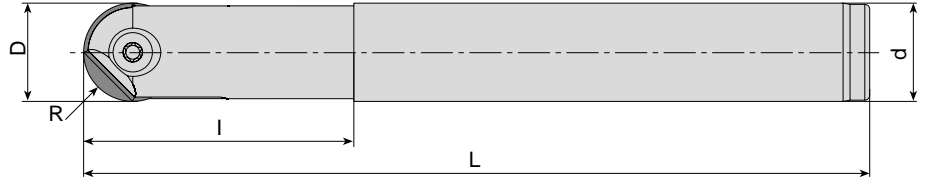

Takım Kodu Ordering Code	Stok Stock	Takım Ölçüleri (mm) Dimension (mm)					Kesici Uç Insert	Yedek Parçaları Spare Parts	
		D	R	d	L	l		Sıkma Vidası Screw	Tork Anahtar Torx Key
APMR-R012-D12-C12-L120	●	12	6	12	120	35		1215-M4x0.5x9	80-T15
APMR-R012-D12-C16-L160	●	12	6	16	160	50			
APMR-R016-D16-C16-L160	●	16	8	16	160	45		1220-M5x0.5x12	80-T20
APMR-R016-D16-C16-L200	●	16	8	16	200	45			
APMR-R016-D16-C20-L200	●	16	8	20	200	65		1220-M5x0.5x15	80-T20
APMR-R020-D20-C20-L160	●	20	10	20	160	55			
APMR-R020-D20-C20-L200	●	20	10	20	200	55			
APMR-R020-D20-C25-L220	●	20	10	25	220	80			

ZCC Ucuna Uygundur. / Compatible with ZCC Insert.

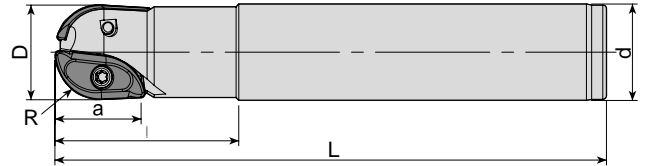

Takım Kodu Ordering Code	Stok Stock	Takım Ölçüleri (mm) Dimension (mm)					Kesici Uç Insert	Yedek Parçaları Spare Parts	
		D	R	d	L	l		Sıkma Vidası Screw	Tork Anahtar Torx Key
APMR-XP16-D16-C16-L150	●	16	8	16	150	40		3008-M2.5x6	80-T08
APMR-XP20-D20-C20-L150	●	20	10	20	150	50			
APMR-XP25-D25-C25-L150	●	25	12.5	25	150	50		4015-M4x9	80-T15

R: Sağ/Right L: Sol/Left ● Stokta/In Stock ○ Stokta Yok/Non Stock Item  
ZCC Ucuna Uygundur. / Compatible with ZCC Insert.

Sipariş Örneği/Ordering Example : 1 ad./pcs. APMR-R012-D12-C12-L120  
Kesme Hesabı : S 271 / Cutting Calculation : P 271

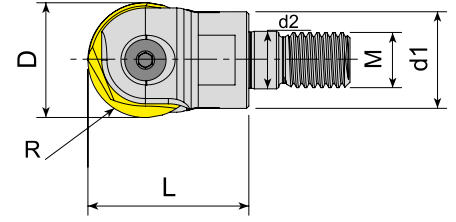

Takım Kodu Ordering Code	Stok Stock	Takım Ölçüleri (mm) Dimension (mm)						Kesici Uç Insert	Yedek Parçaları Spare Parts	
		D	R	d1	M	L	d2		Sıkma Vidası Screw	Tork Anahtar Torx Key
APMR-P3216-D16-M08-L25	●	16	8	14	M08	25	8.5		1220-M5x0.5x12	
APMR-P3220-D20-M10-L30	●	20	10	18	M10	30	10.5		1220-M5x0.5x15	80-T20
APMR-P3225-D25-M12-L35	●	25	12.5	21	M12	35	12.5		1220-M6x0.75x20	
APMR-P3232-D32-M16-L43	●	32	16	30	M16	43	17		1204-M8x0.75x26	AAL-05-4

WLTR Ucuna Uygun. / Compatiple with WLTR Insert.

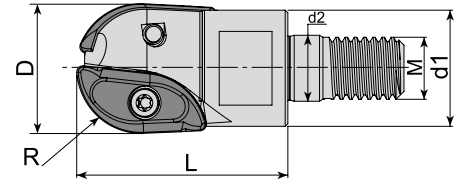

Takım Kodu Ordering Code	Stok Stock	Takım Ölçüleri (mm) Dimension (mm)						Kesici Uç Insert	Yedek Parçaları Spare Parts	
		D	R	d1	M	L	d2		Sıkma Vidası Screw	Tork Anahtar Torx Key
APMR-SWB225-D25-M12-L35	●	25	12.5	23.5	M12	35	12.5		1515-M4x9	80-15
APMR-SWB232-D32-M16-L43	●	32	16	30	M16	43	17		1020-M5x11	80-T20

R: Sağ/Right L: Sol/Left ● Stokta/In Stock ○ Stokta Yok/Non Stock Item  
DJT Ucuna Uygun. / Compatiple with DJT Insert.

Sipariş Örneği/Ordering Example : 1 ad./pcs. APMR-P3216-D16-M08-L25  
Kesme Hesabı : S 271 / Cutting Calculation : P 271  
Sıkma Tork Değeri : S 271 / Tightening Torque : P 271

➤ KÜRE UÇLU MODÜLER PARMAK FREZELER  
BALL NOSE MODULAR (SCREW TYPE) END MILLS

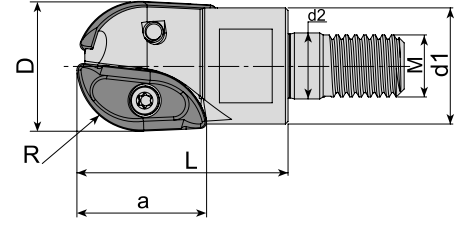

Takım Kodu Ordering Code	Stok Stock	Takım Ölçüleri (mm) Dimension (mm)							Kesici Uç Insert	Yedek Parçaları Spare Parts	
		D	R	d <sub>1</sub>	M	L	a	d <sub>2</sub>		Sıkma Vidası Screw	Tork Anahtar Torx Key
APMR-XP16-D16-M08-L25	●	16	8	14.75	M08	25	16	8.5			
APMR-XP20-D20-M10-L30	●	20	10	18	M10	30	20	10.5	<b>XPHT 20R10T3</b>	3008-M2.5x6	80-T08
APMR-XP25-D25-M12-L40	●	25	12.5	22	M12	40	25	12.5	<b>XPHT 25R1204</b>	1510-M3.5x9	80-T10
										1515-M4x9	80-T15

ZCC Ucuna Uygundur. / Compatible with ZCC Insert.

➤ VİDALI TAKIM TUTUCULARI  
SCREWED TOOL HOLDERS

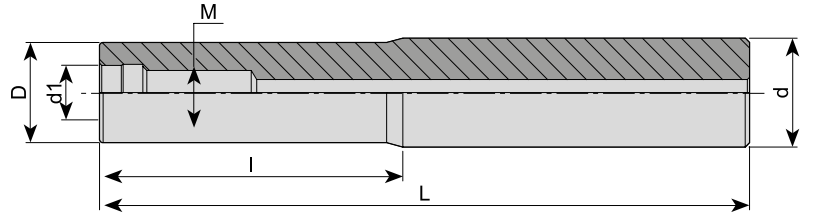

Takım Kodu Ordering Code	Stok Stock	Takım Ölçüleri (mm) Dimension (mm)					
		d	M	d <sub>1</sub>	D	L	I
AVTT-D13-C16-M08-L100-H	●	16	M08	8.5	13	100	40
AVTT-D15-C16-M08-L130-H	●	16	M08	8.5	15	130	70
AVTT-D18-C20-M10-L130-H	●	20	M10	10.5	18	130	70
AVTT-D18-C20-M10-L160-H	●	20	M10	10.5	18	160	80
AVTT-D23-C25-M12-L150-H	●	25	M12	12.5	23	150	70
AVTT-D23-C25-M12-L200-H	●	25	M12	12.5	23	200	100
AVTT-D23-C25-M12-L250-H	●	25	M12	12.5	23	250	150
AVTT-D30-C32-M16-L150-H	●	32	M16	17	30	150	70
AVTT-D30-C32-M16-L200-H	●	32	M16	17	30	200	100
AVTT-D30-C32-M16-L250-H	●	32	M16	17	30	250	150
AVTT-D30-C32-M16-L300-H	●	32	M16	17	30	300	200

R: Sağ/Right L: Sol/Left ● Stokta/In Stock ○ Stokta Yok/Non Stock Item

Sipariş Örneği/Ordering Example : 1 ad./pcs. APMR-XP16-D16-M08-L25  
Kesme Hesabı : S 271 / Cutting Calculation : P 271



www.akkо.com.tr

Дистрибьютер ООО "Ресурс Плюс"  
+7 (351) 247-74-40; info@rp-ural.ru

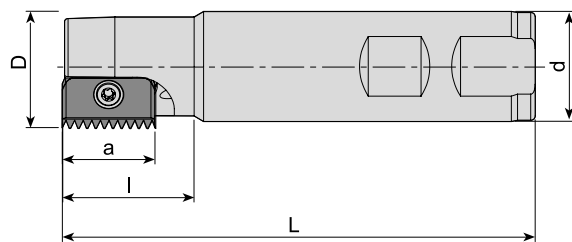

Takım Kodu Ordering Code	Stok Stock	Takım Ölçüleri (mm) Dimension (mm)						Kesici Uç Insert	Yedek Parçaları Spare Parts	
		D	Z	d	L	l	a		Sıkma Vidası Screw	Tork Anahtar Torx Key
ATM-C14-D14-W20-L100-Z01-H	●	14	1	20	100	25	14	C14	3008-M2.5x6	80-T08
ATM-C21-D18-W20-L100-Z01-H	●	18	1	20	100	30	21		1515-M4x9	
ATM-C21-D21-W25-L125-Z01-H	●	21	1	25	125	40	21	C21	1515-M4x11	80-T15
ATM-C21-D25-W20-L125-Z01-H	●	25	1	20	125	30	21			
ATM-C21-D28-W25-L90-Z01-H	●	28	1	25	90	30	21			
ATM-C21-D38-W32-L120-Z03-H	●	38	3	32	120	30	21			
ATM-C21-D43-W32-L90-Z03-H	●	43	3	32	90	30	21			
ATM-C30-D29-W25-L150-Z01-H	●	29	1	25	150	50	30	C30	1020-M5x14	80-T20

CPT Ucuna Uygundur. / Compatible with CPT Insert.

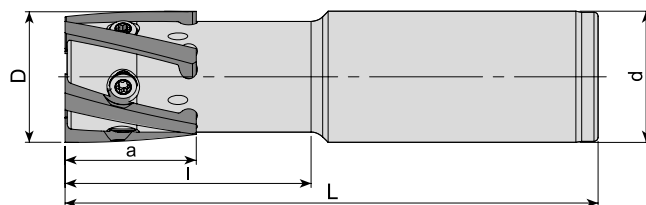

Takım Kodu Ordering Code	Stok Stock	Takım Ölçüleri (mm) Dimension (mm)						Kesici Uç Insert	Yedek Parçaları Spare Parts	
		D	Z	d	L	l	a		Sıkma Vidası Screw	Tork Anahtar Torx Key
ATM-H23-D23-C25-L100-Z02-H	●	23	2	25	100	30	27	H23	1015-M4x8	80-T15
ATM-H32-D32-C32-L130-Z05-H	●	32	5	32	130	35	32	H32	1720-U8-32x10	80-T20

R: Sağ/Right L: Sol/Left ● Stokta/In Stock ○ Stokta Yok/Non Stock Item  
CPT Ucuna Uygundur. / Compatible with CPT Insert.

Sipariş Örneği/Ordering Example : 1 ad./pcs. ATM-C14-D14-W20-L100-Z01-H  
Kesme Hesabı : S 271 / Cutting Calculation : P 271

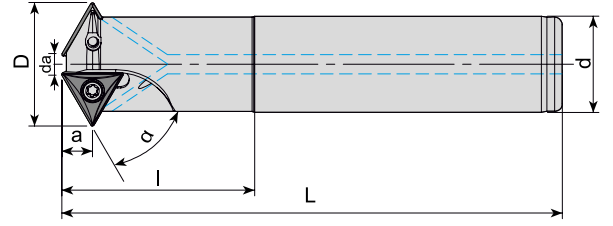

Takım Kodu Ordering Code	Stok Stock	Takım Ölçüleri (mm) Dimension (mm)								Kesici Uç Insert	Yedek Parçaları Spare Parts	
		α	D	d	da	L	l	Z	a		Sıkma Vidası Screw	Tork Anahtar Torx Key
ATM60-TB0601-D13-C10-L150-Z02-H	●	60	13	10	2.5	150	40	2	3.3			
ATM60-TC0902-D20.5-C16-L150-Z02-H	●	60	20.5	16	5.2	150	40	2	4.7	<b>TBGT 060102</b>	3006-M2x4	80-T06
ATM60-TC1102-D26-C20-L150-Z03-H	●	60	26	20	8.3	150	50	3	5.4	<b>TC.T 090202</b>	3007-M2.2x5	80-T07
ATM60-TC16T3-D32-C25-L150-Z02-H	●	60	32	25	6.4	150	50	2	8	<b>TC.T 110202</b>	3008-M2.5x6	80-T08
ATM60-TC16T3-D40-C32-L250-Z03-H	●	60	40	32	13.7	250	50	3	8	<b>TC.T 16T304</b>	4015-M3.5x9	80-T15

R: Sağ/Right L: Sol/Left ● Stokta/In Stock ○ Stokta Yok/Non Stock Item  
ISO Ucuna Uygunudur. / Compatible with ISO Insert.

Sipariş Örneği/Ordering Example : 1 ad./pcs. ATM60-TB0601-D13-C10-L150-Z02-H  
Kesme Hesabı : S 271 / Cutting Calculation : P 271





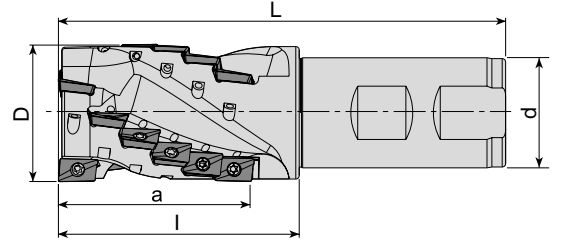

Takım Kodu Ordering Code	Stok Stock	Takım Ölçüleri (mm) Dimension (mm)							Kesici Uç Insert	Yedek Parçaları Spare Parts	
		Z		D	d	a	l	L		Sıkma Vidası Screw	Tork Anahtar Torx Key
		Toplam Total	Etkili Effective								
AHM90-AP10-D20-W20-L087-Z0204	●	4	2	20	20	28	37	87	AP.. 1003..	3008-M2.5x6	80-T08
AHM90-AP10-D20-W20-L087-Z0206	●	6	2	20	20	28	37	87			
AHM90-AP10-D25-W25-L105-Z0208-H	●	8	2	25	25	37	47	105			
AHM90-AP10-D32-W32-L115-Z0315-H	●	15	3	32	32	46	55	115			
AHM90-AP10-D40-W32-L130-Z0318-H	●	18	3	40	32	55	64	130			

R: Sağ/Right L: Sol/Left ● Stokta/In Stock ○ Stokta Yok/Non Stock Item  
ISO Ucuna Uygunudur. / Compatible with ISO Insert.

Sipariş Örneği/Ordering Example : 1 ad./pcs. AHM90-AP10-D20-W20-L087-Z0204  
Kesme Hesabı : S 271 / Cutting Calculation : P 271



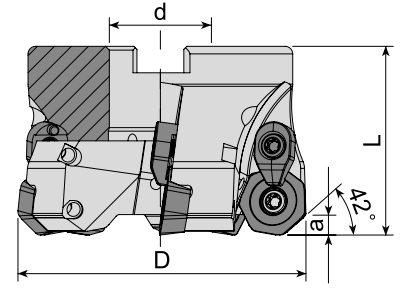

Takım Kodu Ordering Code	Stok Stock	Takım Ölçüleri (mm) Dimension (mm)					Kesici Uç Insert	Yedek Parçaları Spare Parts					
		D	Z	d	L	a		Sıkma Vidası Screw	Baskı Parçası Wedge Clamp	Baskı Vidası Clamp Screw	Tork Anahtar Torx Key	Montaj Vidası Mounting Screw	
AFM42C-XD0806-D063-A27-Z04-H	●	63	4	27	50	12	XDMW 0806..	4020-M4.5x12	ACK-24	4020-M4.5x12	80-T20	2510-M12x35	
AFM42C-XD0806-D080-A27-Z05-H	●	80	5	27	50	12							
AFM42C-XD0806-D100-A32-Z06-H	●	100	6	32	63	12							2514-M16x35
AFM42C-XD0806-D125-B40-Z07	●	125	7	40	63	12							-
AFM42C-XD0806-D160-C40-Z08	●	160	8	40	63	12							-
AFM42C-XD0806-D200-C60-Z09	●	200	9	60	63	12							-

DJT Ucuna Uygunudur. / Compatible with DJT Insert.

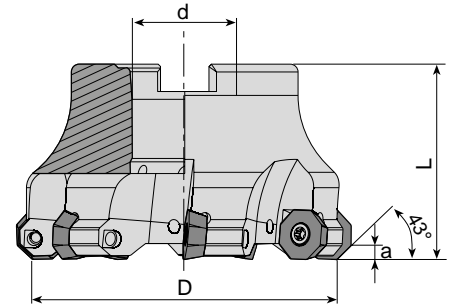

Takım Kodu Ordering Code	Stok Stock	Takım Ölçüleri (mm) Dimension (mm)					Kesici Uç Insert	Yedek Parçaları Spare Parts			
		D	Z	d	L	a		Sıkma Vidası Screw	Tork Anahtar Torx Key	Montaj Vidası Mounting Screw	
AFM43-OD0504-D040-A16-Z04-H	●	40	4	16	40	3.5	OD.. 0504..	4015-M3.5x11	80-T15	2506-M8x30	
AFM43-OD0504-D050-A22-Z05-H	●	50	5	22	40	3.5					
AFM43-OD0504-D063-A22-Z06-H	●	63	6	22	40	3.5					2407-M10x30
AFM43-OD0504-D080-A27-Z07-H	●	80	7	27	50	3.5					2510-M12x35
AFM43-OD0504-D100-A32-Z08-H	●	100	8	32	50	3.5					2514-M16x35

R: Sağ/Right L: Sol/Left ● Stokta/In Stock ○ Stokta Yok/Non Stock Item  
WLTR Ucuna Uygunudur. / Compatible with WLTR Insert.

Sipariş Örneği/Ordering Example : 1 ad./pcs. AFM42C-XD0806-D063-A27-Z04-H  
Kesme Hesabı : S 271 / Cutting Calculation : P 271  
Montaj Ölçüleri : S 269 / Mounting Reference : P 269

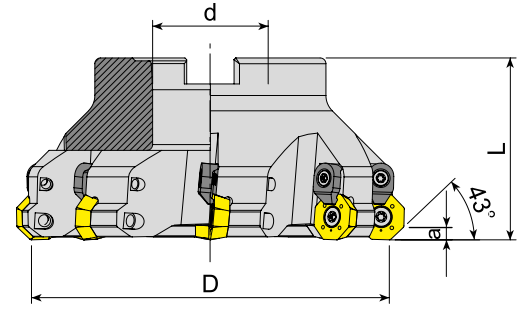

Takım Kodu Ordering Code	Stok Stock	Takım Ölçüleri (mm) Dimension (mm)					Kesici Uç Insert	Yedek Parçaları Spare Parts					
		D	Z	d	L	a		Sıkma Vidası Screw	Baskı Parçası Wedge Clamp	Baskı Vidası Clamp Screw	Tork Anahtar Torx Key	Montaj Vidası Mounting Screw	
AFM43C-OD0605-D080-A27-Z06-H	●	80	6	27	50	4	OD.. 0605..		ACK-05	1515-M4x11		2510-M12x35	
AFM43C-OD0605-D100-A32-Z07-H	●	100	7	32	50	4						1020-M5x11	2514-M16x35
AFM43C-OD0605-D125-B40-Z08	●	125	8	40	63	4						-	-

WLTR-LMN Ucuna Uygunudur. / Compatible with WLTR-LMN Insert.

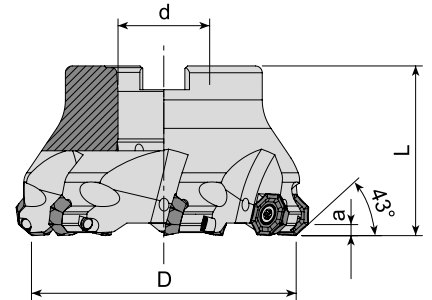

Takım Kodu Ordering Code	Stok Stock	Takım Ölçüleri (mm) Dimension (mm)					Kesici Uç Insert	Yedek Parçaları Spare Parts		
		D	Z	d	L	a		Sıkma Vidası Screw	Tork Anahtar Torx Key	Montaj Vidası Mounting Screw
AFM43-OF05T3-D050-A22-Z05-H	●	50	5	22	40	3	OF.. 05T3..	1515-M4x9	80-T15	2407-M10x30
AFM43-OF05T3-D063-A22-Z06-H	●	63	6	22	40	3		1515-M4x11		2510-M12x35
AFM43-OF05T3-D080-A27-Z07-H	●	80	7	27	50	3		-	-	
AFM43-OF05T3-D125-B40-Z09	●	125	9	40	63	3		-	-	

R: Sağ/Right L: Sol/Left ● Stokta/In Stock ○ Stokta Yok/Non Stock Item  
ISO Ucuna Uygunudur. / Compatible with ISO Insert.

Sipariş Örneği/Ordering Example : 1 ad./pcs. AFM43C-OD0605-D080-A27-Z06-H  
Kesme Hesabı : S 271 / Cutting Calculation : P 271  
Montaj Ölçüleri : S 269 / Mounting Reference : P 269

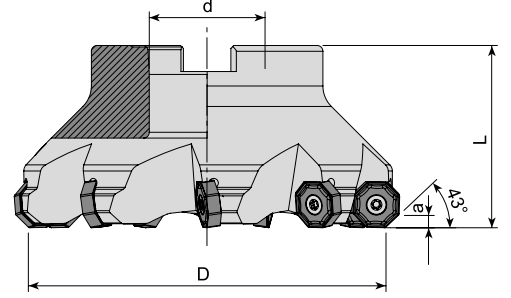

Takım Kodu Ordering Code	Stok Stock	Takım Ölçüleri (mm) Dimension (mm)					Kesici Uç Insert	Yedek Parçaları Spare Parts			
		D	Z	d	L	a		Sıkma Vidası Screw	Tork Anahtar Torx Key	Montaj Vidası Mounting Screw	
AFM43-ON0604-D050-A22-Z05-H	●	50	5	22	40	4	ON.. 0604..				
AFM43-ON0604-D063-A22-Z06-H	●	63	6	22	40	4					2407-M10x30
AFM43-ON0604-D080-A27-Z07-H	●	80	7	27	50	4					2510-M12x35
AFM43-ON0604-D100-A32-Z08-H	●	100	8	32	50	4					2514-M16x35
AFM43-ON0604-D125-B40-Z09	●	125	9	40	63	4					-

ZCC Ucuna Uygunur. / Compatiple with ZCC Insert.

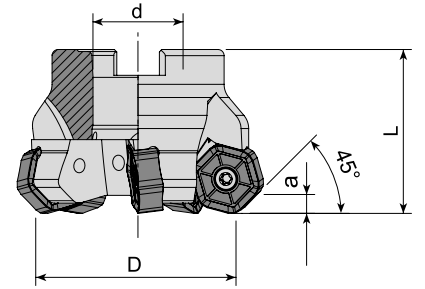

Takım Kodu Ordering Code	Stok Stock	Takım Ölçüleri (mm) Dimension (mm)					Kesici Uç Insert	Yedek Parçaları Spare Parts			
		D	Z	d	L	a		Sıkma Vidası Screw	Tork Anahtar Torx Key	Montaj Vidası Mounting Screw	
AFM45-HN0905-D050-A22-Z05-H	●	50	5	22	40	4.5	HN.. 0905..				
AFM45-HN0905-D063-A22-Z06-H	●	63	6	22	40	4.5					2407-M10x30
AFM45-HN0905-D080-A27-Z07-H	●	80	7	27	50	4.5					2510-M12x35
AFM45-HN0905-D125-B40-Z10	●	125	10	40	63	4.5					-
AFM45-HN0905-D160-C40-Z12	●	160	12	40	63	4.5					
AFM45L-HN0905-D160-C40-Z12	●	160	12	40	63	4.5					
AFM45L-HN0905-D200-C60-Z16	●	200	16	60	63	4.5					

R: Sağ/Right L: Sol/Left ● Stokta/In Stock ○ Stokta Yok/Non Stock Item  
WDA Ucuna Uygunur. / Compatiple with WDA Insert.

Sipariş Örneği/Ordering Example : 1 ad./pcs. AFM43-ON0604-D050-A22-Z05-H  
Kesme Hesabı : S 271 / Cutting Calculation : P 271  
Montaj Ölçüleri : S 269 / Mounting Reference : P 269

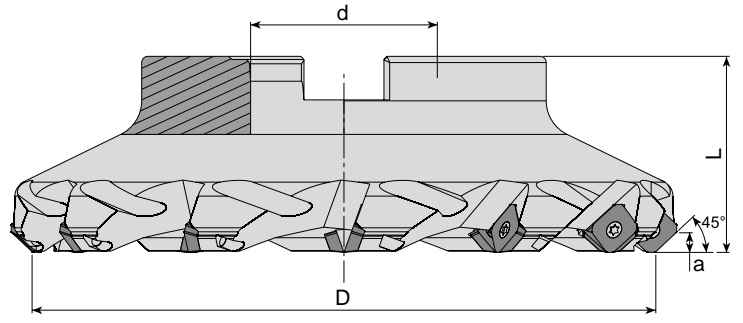

Takım Kodu Ordering Code	Stok Stock	Takım Ölçüleri (mm) Dimension (mm)					Kesici Uç Insert	Yedek Parçaları Spare Parts		
		D	Z	d	L	a		Sıkma Vidası Screw	Tork Anahtar Torx Key	Montaj Vidası Mounting Screw
AFM45-SE12-D050-A22-Z04-H	●	50	4	22	40	6	SE.. 12T3.. R245-12T3..	4015-M3.5x11	80-T15	2407-M10x30
AFM45L-SE12-D050-A22-Z04-H	●	50	4	22	40	6				
AFM45-SE12-D063-A22-Z05-H	●	63	5	22	40	6				
AFM45L-SE12-D063-A22-Z05-H	●	63	5	22	40	6				
AFM45-SE12-D080-A27-Z06-H	●	80	6	27	50	6				2510-M12x35
AFM45L-SE12-D080-A27-Z06-H	●	80	6	27	50	6				
AFM45-SE12-D100-A32-Z07-H	●	100	7	32	50	6				2514-M16x35
AFM45-SE12-D125-B40-Z08	●	125	8	40	63	6				
AFM45-SE12-D160-C40-Z10	●	160	10	40	63	6				-
AFM45-SE12-D200-C60-Z12	●	200	12	60	63	6				-

ZCC-SNDVK Ucuna Uygundur. / Compatible with ZCC-SNDVK Insert.

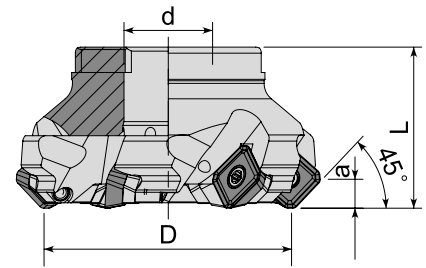

Takım Kodu Ordering Code	Stok Stock	Takım Ölçüleri (mm) Dimension (mm)					Kesici Uç Insert	Yedek Parçaları Spare Parts									
		D	Z	d	L	a		Altık Screw	Altık Vidası Wedge Clamp	Sıkma Vidası Screw	Tork Anahtar Torx Key	Montaj Vidası Mounting Screw					
AFM45-SE13-D050-A22-Z04-H	●	50	4	22	40	6	SEMT 13T3..	AASE-3-0001	AAV-16-M3.5x8	4015-M3.5x12	80-T15	2407-M10x30					
AFM45-SE13-D063-A22-Z05-H	●	63	5	22	40	6											
AFM45-SE13-D080-A27-Z06-H	●	80	6	27	50	6							2510-M12x35				
AFM45S-SE13-D050-A22-Z05-H	●	50	5	22	40	6											
AFM45S-SE13-D063-A22-Z06-H	●	63	6	22	40	6						2407-M10x30					
AFM45S-SE13-D080-A27-Z08-H	●	80	8	27	50	6											
AFM45S-SE13-D100-A32-Z10-H	●	100	10	32	50	6						2510-M12x35					
AFM45S-SE13-D125-B40-Z12	●	125	12	40	63	6											
												-	-	-	-	-	2514-M16x35

R: Sağ/Right L: Sol/Left ● Stokta/In Stock ○ Stokta Yok/Non Stock Item  
SMTM-DJT Ucuna Uygundur. / Compatible with SMTM-DJT Insert.

Sipariş Örneği/Ordering Example : 1 ad./pcs. AFM45-SE12-D050-A22-Z04-H  
Kesme Hesabı : S 271 / Cutting Calculation : P 271  
Montaj Ölçüleri : S 269 / Mounting Reference : P 269

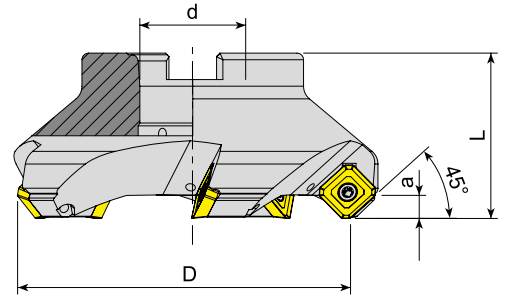

Takım Kodu Ordering Code	Stok Stock	Takım Ölçüleri (mm) Dimension (mm)					Kesici Uç Insert	Yedek Parçaları Spare Parts			
		D	Z	d	L	a		Sıkma Vidası Screw	Tork Anahtar Torx Key	Montaj Vidası Mounting Screw	
AFM45-SE14M4-D063-A22-Z04-H	●	63	4	22	40	7	SE.. 14M4..	4015-M3.5x11	80-T15	2407-M10x30	
AFM45-SE14M4-D080-A27-Z05-H	●	80	5	27	50	7				2510-M12x35	
AFM45-SE14M4-D100-A32-Z05-H	●	100	5	32	50	7				2514-M16x35	
AFM45-SE14M4-D125-B40-Z06	●	125	6	40	63	7				-	
AFM45-SE14M4-D160-C40-Z07	●	160	7	40	63	7				-	

KRLY Ucuna Uygun. / Compatible with KRLY Insert.

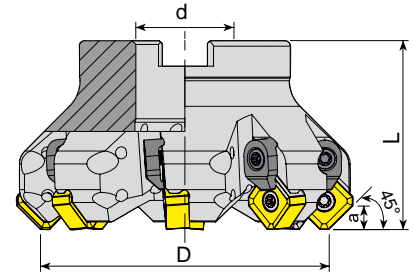

Takım Kodu Ordering Code	Stok Stock	Takım Ölçüleri (mm) Dimension (mm)					Kesici Uç Insert	Yedek Parçaları Spare Parts				
		D	Z	d	L	a		Sıkma Vidası Screw	Baskı Parçası Wedge Clamp	Baskı Vidası Clamp Screw	Tork Anahtar Torx Key	Montaj Vidası Mounting Screw
AFM45C-SN12..-D050-A22-Z04-H	●	50	4	22	42	6	SN.. 1206..	1015-M4x11	ACK-05	4015-M4x11	80-T15	2407-M10x30
AFM45C-SN12..-D050-A22-Z05-H	●	50	5	22	42	6						2510-M12x35
AFM45C-SN12..-D063-A22-Z06-H	●	63	6	22	42	6						2514-M16x35
AFM45C-SN12..-D063-A22-Z07-H	●	63	7	22	42	6						-
AFM45CL-SN12..-D063-A22-Z07-H	●	63	7	22	42	6						-
AFM45C-SN12..-D080-A27-Z07-H	●	80	7	27	52	6						-
AFM45C-SN12..-D080-A27-Z08-H	●	80	8	27	52	6						-
AFM45CL-SN12..-D080-A27-Z08-H	●	80	8	27	52	6						-
AFM45C-SN12..-D100-A32-Z08-H	●	100	8	32	52	6						-
AFM45C-SN12..-D100-A32-Z10-H	●	100	10	32	52	6						-
AFM45CL-SN12..-D100-A32-Z10-H	●	100	10	32	52	6						-
AFM45C-SN12..-D125-B40-Z11	●	125	11	40	65	6						-
AFM45CL-SN12..-D125-B40-Z11	●	125	11	40	65	6						-
AFM45C-SN12..-D160-C40-Z12	●	160	12	40	65	6						-
AFM45C-SN12..-D200-C60-Z14	●	200	14	60	65	6						-
AFM45CL-SN12..-D200-C60-Z14	●	200	14	60	65	6						-

R: Sağ/Right L: Sol/Left ● Stokta/In Stock ○ Stokta Yok/Non Stock Item

WLTR-LMN-ACHTK Ucuna Uygun. / Compatible with WLTR-LMN-ACHTK Insert.

Sipariş Örneği/Ordering Example : 1 ad./pcs. AFM45-SE14M4-D063-A22-Z04-H

Kesme Hesabı : S 271 / Cutting Calculation : P 271

Montaj Ölçüleri : S 269 / Mounting Reference : P 269



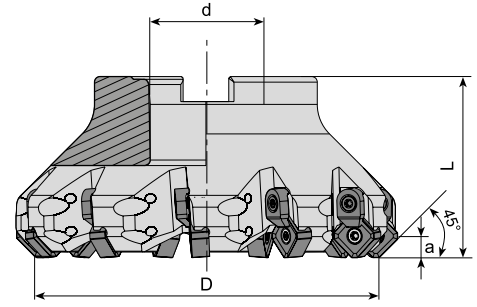

Takım Kodu Ordering Code	Stok Stock	Takım Ölçüleri (mm) Dimension (mm)					Kesici Uç Insert	Yedek Parçaları Spare Parts				
		D	Z	d	L	a		Sıkma Vidası Screw	Baskı Parçası Wedge Clamp	Baskı Vidası Clamp Screw	Tork Anahtar Torx Key	Montaj Vidası Mounting Screw
AFM45C-SN1206-D050-A22-Z04-H	●	50	4	22	42	6	SN.. 1206..	1515-M4x11	ACK-05	1515-M4x11	80-T15	2407-M10x30
AFM45C-SN1206-D050-A22-Z05-H	●	50	5	22	42	6						
AFM45C-SN1206-D063-A22-Z06-H	●	63	6	22	42	6						
AFM45C-SN1206-D063-A22-Z07-H	●	63	7	22	42	6						
AFM45CL-SN1206-D063-A22-Z07-H	●	63	7	22	42	6						
AFM45C-SN1206-D080-A27-Z07-H	●	80	7	27	52	6						
AFM45C-SN1206-D080-A27-Z08-H	●	80	8	27	52	6						
AFM45CL-SN1206-D080-A27-Z08-H	●	80	8	27	52	6						
AFM45C-SN1206-D100-A32-Z08-H	●	100	8	32	52	6						
AFM45C-SN1206-D100-A32-Z10-H	●	100	10	32	52	6						
AFM45CL-SN1206-D100-A32-Z10-H	●	100	10	32	52	6						
AFM45C-SN1206-D125-B40-Z11	●	125	11	40	65	6						
AFM45CL-SN1206-D125-B40-Z11	●	125	11	40	65	6						
AFM45C-SN1206-D160-C40-Z12	●	160	12	40	65	6						
AFM45C-SN1206-D200-C60-Z14	●	200	14	60	65	6						
AFM45CL-SN1206-D200-C60-Z14	●	200	14	60	65	6						

KRLY-PLBT-BHLR Ucuna Uygundur. / Compatible with KRLY-PLBT-BHLR Insert.

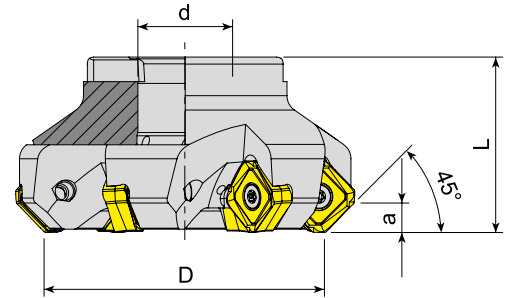

Takım Kodu Ordering Code	Stok Stock	Takım Ölçüleri (mm) Dimension (mm)					Kesici Uç Insert	Yedek Parçaları Spare Parts		
		D	Z	d	L	a		Sıkma Vidası Screw	Tork Anahtar Torx Key	Montaj Vidası Mounting Screw
AFM45-SA1706-D080-A27-Z06-H	●	80	6	27	50	8.4	SAKU 1706..	1020-M5x14	80-T20	2510-M12x35
AFM45-SA1706-D100-A32-Z07-H	●	100	7	32	50	8.4				2514-M16x35
AFM45-SA1706-D125-B40-Z09	●	125	9	40	63	8.4				-

R: Sağ/Right L: Sol/Left ● Stokta/In Stock ○ Stokta Yok/Non Stock Item  
CRTZT Ucuna Uygundur. / Compatible with CRTZT Insert.

Sipariş Örneği/Ordering Example : 1 ad./pcs. AFM45C-SN1206-D050-A22-Z04-H  
Kesme Hesabı : S 271 / Cutting Calculation : P 271  
Montaj Ölçüleri : S 269 / Mounting Reference : P 269

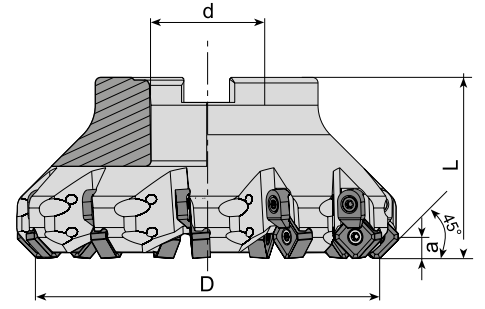

Takım Kodu Ordering Code	Stok Stock	Takım Ölçüleri (mm) Dimension (mm)					Kesici Uç Insert	Yedek Parçaları Spare Parts					
		D	Z	d	L	a		Sıkma Vidası Screw	Baskı Parçası Wedge Clamp	Baskı Vidası Clamp Screw	Tork Anahtar Torx Key	Montaj Vidası Mounting Screw	
AFM45C-SN12Z-D050-A22-Z05-H	●	50	5	22	42	6	SNEG 1205..						2407-M10X30
AFM45C-SN12Z-D063-A22-Z06-H	●	63	6	22	42	6							2510-M12x35
AFM45C-SN12Z-D080-A27-Z07-H	●	80	7	27	52	6							2514-M16x35
AFM45C-SN12Z-D100-A32-Z09-H	●	100	9	32	52	6							-
AFM45C-SN12Z-D125-B40-Z11	●	125	11	40	65	6							-
AFM45C-SN12Z-D160-C40-Z12	●	160	12	60	65	6							-
AFM45C-SN12Z-D200-C60-Z14	●	200	14	60	65	6							-

ZCC Ucuna Uygundur. / Compatible with ZCC Insert.

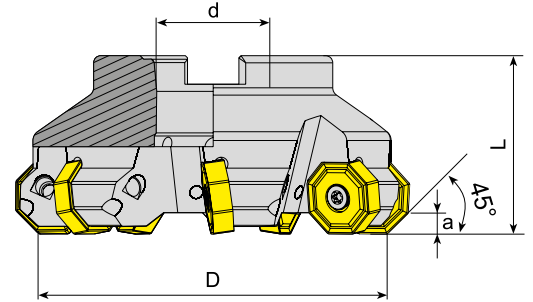

Takım Kodu Ordering Code	Stok Stock	Takım Ölçüleri (mm) Dimension (mm)					Kesici Uç Insert	Yedek Parçaları Spare Parts			
		D	Z	d	L	a		Sıkma Vidası Screw	Tork Anahtar Torx Key	Montaj Vidası Mounting Screw	
AFM45-ON0806-D063-A22-Z05-H	●	63	5	22	40	4	ON.. 0806..				2508-M10x30
AFM45-ON0806-D080-A27-Z06-H	●	80	6	27	50	4					2510-M12x35
AFM45-ON0806-D100-A32-Z07-H	●	100	7	32	50	4					2514-M16x35
AFM45-ON0806-D125-B40-Z08	●	125	8	40	63	4					-
AFM45-ON0806-D160-C40-Z10	●	160	10	40	63	4					-
AFM45-ON0806-D200-C60-Z12	●	200	12	60	63	4					-
AFM45-ON0806-D315-D60-Z16	●	315	16	60	63	4					-

R: Sağ/Right L: Sol/Left ● Stokta/In Stock ○ Stokta Yok/Non Stock Item  
ISO Ucuna Uygundur. / Compatible with ISO Insert.

Sipariş Örneği/Ordering Example : 1 ad./pcs. AFM45C-SN12Z-D050-A22-Z05-H  
Kesme Hesabı : S 271 / Cutting Calculation : P 271  
Montaj Ölçüleri : S 269 / Mounting Reference : P 269



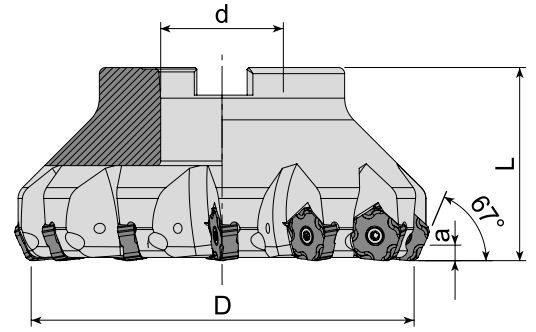

Takım Kodu Ordering Code	Stok Stock	Takım Ölçüleri (mm) Dimension (mm)					Kesici Uç Insert	Yedek Parçaları Spare Parts		
		D	Z	d	L	a		Sıkma Vidası Screw	Tork Anahtar Torx Key	Montaj Vidası Mounting Screw
AFM67-PN1105-D050-A22-Z05	●	50	5	22	50	5	PNEG 1105..	1515-M4x11	80-T15	2508-M10x30
AFM67-PN1105-D063-A22-Z06	●	63	6	22	50	5				
AFM67-PN1105-D080-A27-Z08	●	80	8	27	50	5				
AFM67-PN1105-D100-B32-Z10	●	100	10	32	50	5				
AFM67-PN1105-D125-B40-Z12	●	125	12	40	63	5				
AFM67-PN1105-D160-C40-Z14	●	160	14	40	63	5				

ZCC Ucuna Uygunudur. / Compatible with ZCC Insert.

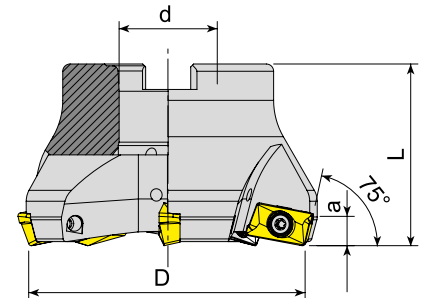

Takım Kodu Ordering Code	Stok Stock	Takım Ölçüleri (mm) Dimension (mm)					Kesici Uç Insert	Yedek Parçaları Spare Parts		
		D	Z	d	L	a		Sıkma Vidası Screw	Tork Anahtar Torx Key	Montaj Vidası Mounting Screw
AFM75-AP16-D063-A22-Z04-H	●	63	4	22	40	6	AP.. 1604..	1515-M4x11	80-T15	2508-M10x30
AFM75-AP16-D080-A27-Z05-H	●	80	5	27	50	6				2510-M12x35
AFM75-AP16-D100-A32-Z06-H	●	100	6	32	50	6				2514-M16x35
AFM75-AP16-D125-B40-Z07	●	125	7	40	63	6				-

R: Sağ/Right L: Sol/Left ● Stokta/In Stock ○ Stokta Yok/Non Stock Item  
ISO Ucuna Uygunudur. / Compatible with ISO Insert.

Sipariş Örneği/Ordering Example : 1 ad./pcs. AFM67-PN1105-D050-A22-Z05  
Kesme Hesabı : S 271 / Cutting Calculation : P 271  
Montaj Ölçüleri : S 269 / Mounting Reference : P 269

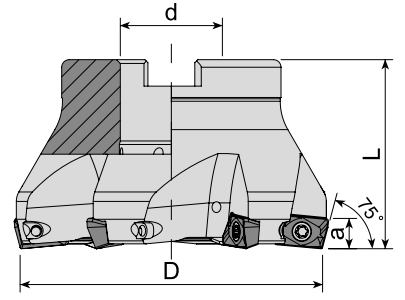

Takım Kodu Ordering Code	Stok Stock	Takım Ölçüleri (mm) Dimension (mm)					Kesici Uç Insert	Yedek Parçaları Spare Parts			
		D	Z	d	L	a		Sıkma Vidası Screw	Tork Anahtar Torx Key	Montaj Vidası Torx Key	
AFM75-X012-D050-A22-Z04-H	●	50	4	22	40	-	XOMX 1204..		1510-M3.5x9		2508-M10x30
AFM75-X012-D063-A22-Z05-H	●	63	5	22	40	-					
AFM75-X012-D080-A27-Z06-H	●	80	6	27	50	-					

SC Ucuna Uygun. / Compatible with SC Insert.

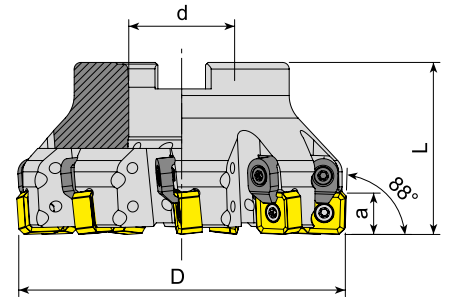

Takım Kodu Ordering Code	Stok Stock	Takım Ölçüleri (mm) Dimension (mm)					Kesici Uç Insert	Yedek Parçaları Spare Parts				
		D	Z	d	L	a		Sıkma Vidası Screw	Baskı Parçası Wedge Clamp	Baskı Vidası Clamp Screw	Tork Anahtar Torx Key	Montaj Vidası Mounting Screw
AFM88C-SN1206-D063-A22-Z06-H	●	63	6	22	40	11.5	SN.. 1206..			1515-M4x11		2508-M10x30
AFM88C-SN1206-D080-A27-Z07-H	●	80	7	27	50	11.5						
AFM88C-SN1206-D100-A32-Z09-H	●	100	9	32	52	11.5						

R: Sağ/Right L: Sol/Left ● Stokta/In Stock ○ Stokta Yok/Non Stock Item  
ISO Ucuna Uygun. / Compatible with ISO Insert.

Sipariş Örneği/Ordering Example : 1 ad./pcs. AFM75-X012-D050-A22-Z04-H  
Kesme Hesabı : S 271 / Cutting Calculation : P 271  
Montaj Ölçüleri : S 269 / Mounting Reference : P 269



88°

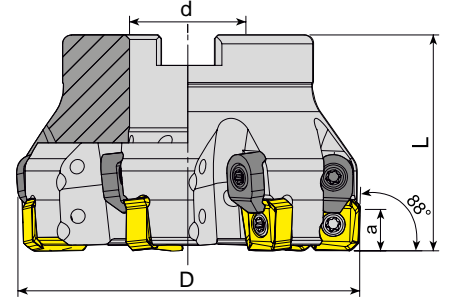

Takım Kodu Ordering Code	Stok Stock	Takım Ölçüleri (mm) Dimension (mm)					Kesici Uç Insert	Yedek Parçaları Spare Parts				
		D	Z	d	L	a		Sıkma Vidası Screw	Baskı Parçası Wedge Clamp	Baskı Vidası Clamp Screw	Tork Anahtar Torx Key	Montaj Vidası Mounting Screw
AFM88C-SN12Z-D063-A22-Z06-H	●	63	6	22	40	11.5	SNEG 1205..					
AFM88C-SN12Z-D080-A27-Z07-H	●	80	7	27	50	11.5						

ZCC Ucuna Uygundur. / Compatiple with ZCC Insert.

90°

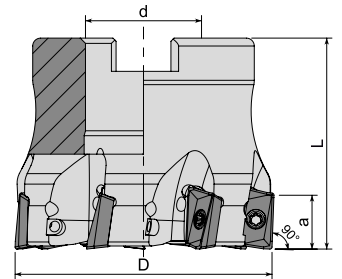

Takım Kodu Ordering Code	Stok Stock	Takım Ölçüleri (mm) Dimension (mm)					Kesici Uç Insert	Yedek Parçaları Spare Parts		
		D	Z	d	L	a		Sıkma Vidası Screw	Tork Anahtar Torx Key	Montaj Vidası Torx Key
AFM90-AD10T3-D040-A16-Z06-H	●	40	6	16	40	10				
AFM90-AD10T3-D050-A22-Z07-H	●	50	7	22	40	10				

R: Sağ/Right L: Sol/Left ● Stokta/In Stock ○ Stokta Yok/Non Stock Item  
WLTR Ucuna Uygundur. / Compatiple with WLTR Insert.

Sipariş Örneği/Ordering Example : 1 ad./pcs. AFM88C-SN12Z-D063-A22-Z06-H  
Kesme Hesabı : S 271 / Cutting Calculation : P 271  
Montaj Ölçüleri : S 269 / Mounting Reference : P 269

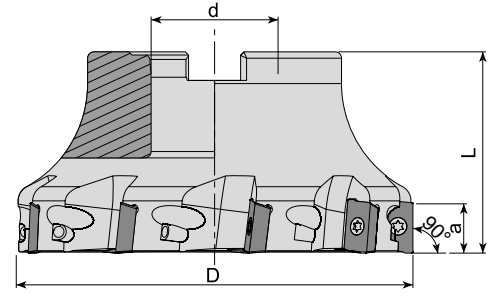

Takım Kodu Ordering Code	Stok Stock	Takım Ölçüleri (mm) Dimension (mm)					Kesici Uç Insert	Yedek Parçaları Spare Parts		
		D	Z	d	L	a		Sıkma Vidası Screw	Tork Anahtar Torx Key	Montaj Vidası Mounting Screw
AFM90-AD1505-D040-A16-Z04-H	●	40	4	16	40	15	AD.. 1505..	1515-M4x11	80-T15	2506-M8x30
AFM90-AD1505-D050-A22-Z05-H	●	50	5	22	40	15				2508-M10x30
AFM90-AD1505-D063-A22-Z06-H	●	63	6	22	40	15				2510-M12x35
AFM90-AD1505-D080-A27-Z07-H	●	80	7	27	50	15				2514-M16x35
AFM90-AD1505-D100-A32-Z08-H	●	100	8	32	50	15				-
AFM90-AD1505-D125-B40-Z09	●	125	9	40	63	15				-

ISCR Ucuna Uygunudur. / Compatible with ISCR Insert.

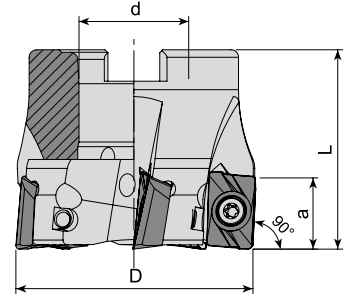

Takım Kodu Ordering Code	Stok Stock	Takım Ölçüleri (mm) Dimension (mm)					Kesici Uç Insert	Yedek Parçaları Spare Parts		
		D	Z	d	L	a		Sıkma Vidası Screw	Tork Anahtar Torx Key	Montaj Vidası Mounting Screw
AFM90-AD1505D-D050-A22-Z05-H	●	50	5	22	40	14.3	ADKT 150508	1515-M4x11	80-T15	2508-M10x30
AFM90-AD1505D-D063-A27-Z06-H	●	63	6	27	50	14.3				2510-M12x35
AFM90-AD1505D-D080-A27-Z08-H	●	80	8	27	50	14.3				-

R: Sağ/Right L: Sol/Left ● Stokta/In Stock ○ Stokta Yok/Non Stock Item  
DJT Ucuna Uygunudur. / Compatible with DJT Insert.

Sipariş Örneği/Ordering Example : 1 ad./pcs. AFM90-AD1505-D040-A16-Z04-H  
Kesme Hesabı : S 271 / Cutting Calculation : P 271  
Montaj Ölçüleri : S 269 / Mounting Reference : P 269

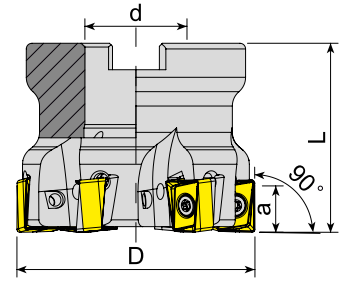

Takım Kodu Ordering Code	Stok Stock	Takım Ölçüleri (mm) Dimension (mm)					Kesici Uç Insert	Yedek Parçaları Spare Parts		
		D	Z	d	L	a		Sıkma Vidası Screw	Tork Anahtar Torx Key	Montaj Vidası Torx Key
AFM90-AN12-D040-A16-Z04-H	●	40	4	16	40	12	ANKX 1205..	4015-M4x12	80-T15	2406-M8x30
AFM90-AN12-D050-A22-Z05-H	●	50	5	22	40	12				2508-M10x30
AFM90-AN12-D063-A27-Z06-H	●	63	6	27	50	12				2510-M12x35

ISCR Ucuna Uygundur. / Compatible with ISCR Insert.

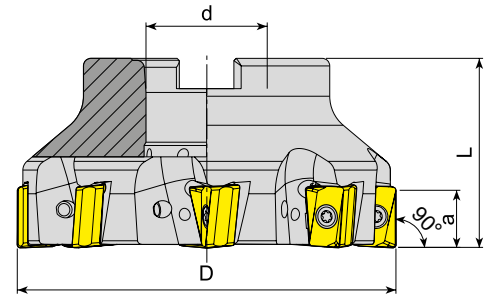

Takım Kodu Ordering Code	Stok Stock	Takım Ölçüleri (mm) Dimension (mm)					Kesici Uç Insert	Yedek Parçaları Spare Parts		
		D	Z	d	L	a		Sıkma Vidası Screw	Tork Anahtar Torx Key	Montaj Vidası Mounting Screw
AFM90-AN1607-D050-A22-Z04-H	●	50	4	22	40	15	AN.X 1607..	1515-M4x11	80-T15	2508-M10x30
AFM90-AN1607-D063-A22-Z06-H	●	63	6	22	40	15				2510-M12x35
AFM90-AN1607-D080-A27-Z07-H	●	80	7	27	50	15				2514-M16x35
AFM90-AN1607-D100-A32-Z08-H	●	100	8	32	50	15				

R: Sağ/Right L: Sol/Left ● Stokta/In Stock ○ Stokta Yok/Non Stock Item  
TGTC Ucuna Uygundur. / Compatible with TGTC Insert.

Sipariş Örneği/Ordering Example : 1 ad./pcs. AFM90-AN12-D040-A16-Z04-H  
Kesme Hesabı : S 271 / Cutting Calculation : P 271  
Montaj Ölçüleri : S 269 / Mounting Reference : P 269

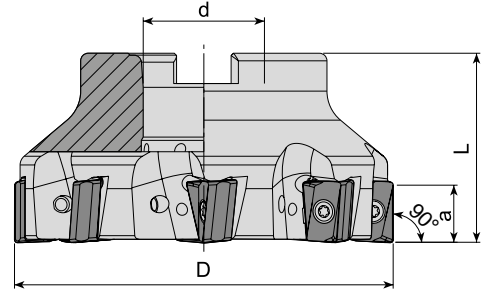

Takım Kodu Ordering Code	Stok Stock	Takım Ölçüleri (mm) Dimension (mm)					Kesici Uç Insert	Yedek Parçaları Spare Parts		
		D	Z	d	L	a		Sıkma Vidası Screw	Tork Anahtar Torx Key	Montaj Vidası Mounting Screw
AFM90-AN11-D040-A16-Z04-H	●	40	4	16	40	11	ANGX 1105..	4010-M3x8	80-T10	2506-M8x30
AFM90-AN1506-D050-A22-Z04-H	●	50	4	22	40	14.5	ANGX 1506..	4015-M4x12	80-T15	2508-M10x30
AFM90-AN1506-D063-A22-Z05-H	●	63	5	22	40	14.5				2510-M12x35
AFM90-AN1506-D080-A27-Z06-H	●	80	6	27	50	14.5				2514-M16x35
AFM90-AN1506-D100-A32-Z08-H	●	100	8	32	50	14.5				-
AFM90-AN1506-D125-B40-Z09	●	125	9	40	63	14.5				-
AFM90-AN1506-D160-C40-Z10	●	160	10	40	63	14.5	-	-	-	

ZCC Ucuna Uygunudur. / Compatible with ZCC Insert.

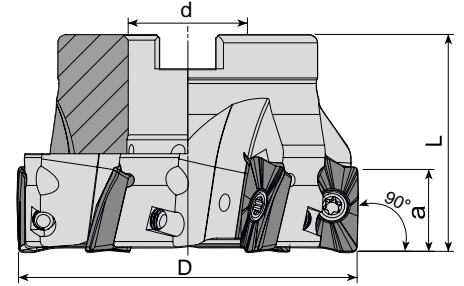

Takım Kodu Ordering Code	Stok Stock	Takım Ölçüleri (mm) Dimension (mm)					Kesici Uç Insert	Yedek Parçaları Spare Parts		
		D	Z	d	L	a		Sıkma Vidası Screw	Tork Anahtar Torx Key	Montaj Vidası Mounting Screw
AFM90-AO1236-D050-A22-Z05-H	●	50	5	22	40	12	AO.. 1236..	3008-M2.5x6	80-T08	2508-M10x30
AFM90-AO1848-D050-A22-Z05-H	●	50	5	22	40	15	AO.. 1848..	4015-M4x11	80-T15	2508-M10x30
AFM90-AO1848-D063-A22-Z06-H	●	63	6	22	40	15				

R: Sağ/Right L: Sol/Left ● Stokta/In Stock ○ Stokta Yok/Non Stock Item  
MTSBH Ucuna Uygunudur. / Compatible with MTSBH Insert.

Sipariş Örneği/Ordering Example : 1 ad./pcs. AFM90-AN11-D040-A16-Z04-H  
Kesme Hesabı : S 271 / Cutting Calculation : P 271  
Montaj Ölçüleri : S 269 / Mounting Reference : P 269

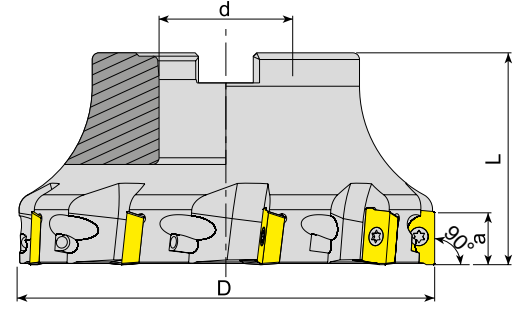

Takım Kodu Ordering Code	Stok Stock	Takım Ölçüleri (mm) Dimension (mm)					Kesici Uç Insert	Yedek Parçaları Spare Parts		
		D	Z	d	L	a		Sıkma Vidası Screw	Tork Anahtar Torx Key	Montaj Vidası Mounting Screw
AFM90-AP10-D040-A16-Z05-H	●	40	5	16	40	10	AP.. 1003.. ISO UCUNA UYGUNDUR. FOR ISO INSERT.	3008-M2.5x6	80-T08	2506-M8x30
AFM90-AP10-D050-A22-Z06-H	●	50	6	22	40	10				2508-M10x30
AFM90-AP10-D063-A22-Z07-H	●	63	7	22	40	10				2510-M12x35
AFM90-AP10-D080-A27-Z08-H	●	80	8	27	50	10				2514-M16x35
AFM90-AP10-D100-A32-Z09-H	●	100	9	32	50	10				2506-M8x30
AFM90-AP16-D040-A16-Z04-H	●	40	4	16	40	16	AP.. 1604.. ISO UCUNA UYGUNDUR. FOR ISO INSERT.			2508-M10x30
AFM90-AP16-D050-A22-Z05-H	●	50	5	22	40	16				2510-M12x35
AFM90-AP16-D052-A22-Z05-H	●	52	5	22	40	16				2514-M16x35
AFM90-AP16-D063-A22-Z06-H	●	63	6	22	40	16				-
AFM90-AP16-D080-A27-Z07-H	●	80	7	27	50	16				
AFM90-AP16-D100-A32-Z08-H	●	100	8	32	50	16				
AFM90-AP16-D125-B40-Z09	●	125	9	40	63	16				
AFM90-AP16-D160-C40-Z10	●	160	10	40	63	16				
AFM90-AP16-D200-C60-Z12	●	200	12	60	63	16				
AFM90-AP16DJ-D050-A22-Z05-H	●	50	5	22	40	16	AP.. 1604.. DJT UCUNA UYGUNDUR. FOR DJT INSERT.	1515-M4x11	80-T15	2508-M10x30
AFM90-AP16DJ-D063-A22-Z06-H	●	63	6	22	40	16				2510-M12x35
AFM90-AP16DJ-D080-A27-Z07-H	●	80	7	27	50	16				2508-M10x30
AFM90-AP16L-D050-A22-Z05-H	●	50	5	22	40	16	AP.. 1604.. LMN UCUNA UYGUNDUR. FOR LMN INSERT.			2510-M12x35
AFM90-AP16L-D063-A22-Z06-H	●	63	6	22	40	16				2508-M10x30
AFM90-AP16L-D080-A27-Z07-H	●	80	7	27	50	16				2510-M12x35
AFM90-AP16P-D040-A16-Z04-H	●	40	4	16	40	16	AP.. 1604.. PLBT UCUNA UYGUNDUR. FOR PLBT INSERT.			2506-M8x30
AFM90-AP16P-D050-A22-Z05-H	●	50	5	22	40	16				2508-M10x30
AFM90-AP16P-D063-A22-Z06-H	●	63	6	22	40	16				2510-M12x35
AFM90-AP16P-D080-A27-Z07-H	●	80	7	27	50	16				2514-M16x35
AFM90-AP16P-D100-A32-Z08-H	●	100	8	32	50	16				
AFM90-AP1705-D050-A22-Z05-H	●	50	5	22	40	16	AP.. 1705.. TGTC-LMN UCUNA UYGUNDUR. FOR TGTC-LMN INSERT.			2508-M10x30
AFM90-AP1705-D063-A22-Z06-H	●	63	6	22	40	16				2510-M12x35
AFM90-AP1705-D080-A27-Z07-H	●	80	7	27	50	16				2514-M16x35
AFM90-AP1705-D100-A32-Z08-H	●	100	8	32	50	16				

R: Sağ/Right L: Sol/Left ● Stokta/In Stock ○ Stokta Yok/Non Stock Item

Sipariş Örneği/Ordering Example : 1 ad./pcs. AFM90-AP10-D040-A16-Z05-H

Kesme Hesabı : S 271 / Cutting Calculation : P 271

Montaj Ölçüleri : S 269 / Mounting Reference : P 269

240 / 241

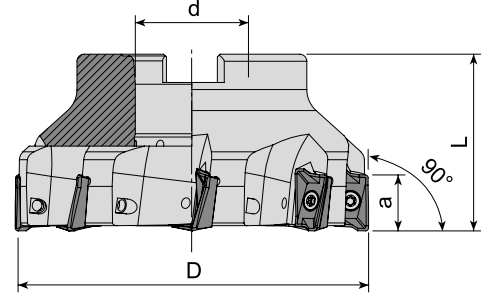

Takım Kodu Ordering Code	Stok Stock	Takım Ölçüleri (mm) Dimension (mm)					Kesici Uç Insert	Yedek Parçaları Spare Parts		
		D	Z	d	L	a		Sıkma Vidası Screw	Tork Anahtar Torx Key	Montaj Vidası Mounting Screw
AFM90-AX1235-D040-A16-Z06-H	●	40	6	16	40	10	AX.T 1235..	3108-M3x6	80-T08	2506-M8x30
AFM90-AX1235-D050-A22-Z07-H	●	50	7	22	40	10				2508-M10x30
AFM90-AX1235-D063-A22-Z08-H	●	63	8	22	40	10				2510-M12x35
AFM90-AX1235-D080-A27-Z10-H	●	80	10	27	50	10				2506-M8x30
AFM90-AX1705-D040-A16-Z04-H	●	40	4	16	40	14	AX.T 1705..	4015-M4x11	80-T15	2506-M8x30
AFM90-AX1705-D050-A22-Z05-H	●	50	5	22	40	14				2508-M10x30
AFM90-AX1705-D063-A22-Z06-H	●	63	6	22	40	14				2510-M12x35
AFM90-AX1705-D080-A27-Z07-H	●	80	7	27	50	14				2514-M16x35
AFM90-AX1705-D100-A32-Z08-H	●	100	8	32	50	14				

SMTM Ucuna Uygunudur. / Compatible with SMTM Insert.

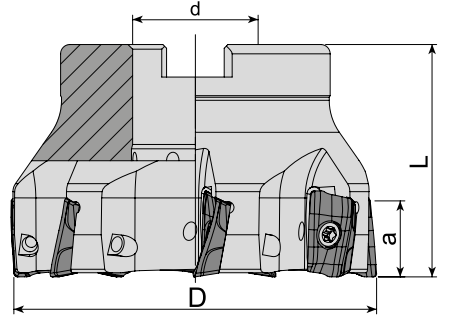

Takım Kodu Ordering Code	Stok Stock	Takım Ölçüleri (mm) Dimension (mm)					Kesici Uç Insert	Yedek Parçaları Spare Parts		
		D	Z	d	L	a		Sıkma Vidası Screw	Tork Anahtar Torx Key	Montaj Vidası Mounting Screw
AFM90-BD1704-D050-A22-Z05-H	●	50	5	22	40	15.7	BDMT 1704..	1515-M4x11	80-T15	2508-M10x30
AFM90-BD1704-D063-A22-Z06-H	●	63	6	22	40	15.7				2510-M12x35
AFM90-BD1704-D080-A27-Z07-H	●	80	7	27	50	15.7				

R: Sağ/Right L: Sol/Left ● Stokta/In Stock ○ Stokta Yok/Non Stock Item  
KYCR Ucuna Uygunudur. / Compatible with KYCR Insert.

Sipariş Örneği/Ordering Example : 1 ad./pcs. AFM90-AX1235-D040-A16-Z06-H  
Kesme Hesabı : S 271 / Cutting Calculation : P 271  
Montaj Ölçüleri : S 269 / Mounting Reference : P 269



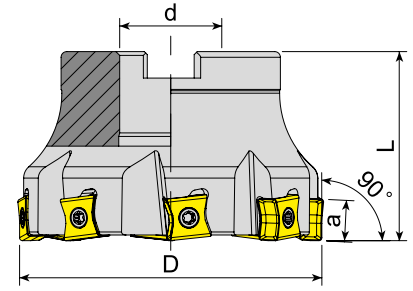

Takım Kodu Ordering Code	Stok Stock	Takım Ölçüleri (mm) Dimension (mm)					Kesici Uç Insert	Yedek Parçaları Spare Parts		
		D	Z	d	L	a		Sıkma Vidası Screw	Tork Anahtar Torx Key	Montaj Vidası Torx Key
AFM90-LN1106-D050-A22-Z05	●	50	5	22	40	10	LNMT 1106..	4015-M3.5x11	80-T15	2508-M10x30
AFM90-LN1106-D063-A22-Z06	●	63	6	22	40	10				2510-M12x35
AFM90-LN1106-D080-A27-Z08	●	80	8	27	50	10				2514-M16x35
AFM90L-LN1106-D080-A27-Z08	●	80	8	27	50	10				-
AFM90-LN1106-D100-A32-Z09	●	100	9	32	50	10				2506-M8x30
AFM90L-LN1106-D100-A32-Z09	●	100	9	32	50	10				2508-M10x30
AFM90-LN1106-D125-B40-Z10	●	125	10	40	63	10				2510-M12x35
AFM90-LN1306-D040-A16-Z04-H	●	40	4	16	40	12.5	LNMT 1306..	4015-M4x11	80-T15	2514-M16x35
AFM90-LN1306-D050-A22-Z05-H	●	50	5	22	40	12.5				2506-M8x30
AFM90-LN1306-D063-A22-Z06-H	●	63	6	22	40	12.5				2508-M10x30
AFM90-LN1306-D080-A27-Z07-H	●	80	7	27	50	12.5				2510-M12x35
AFM90-LN1306-D100-A32-Z08-H	●	100	8	32	50	12.5				2514-M16x35
AFM90L-LN1506-D040-A16-Z04	●	40	4	16	40	14	LNMT 1506..	4015-M4x9	80-T20	2506-M8x30
AFM90-LN1506-D040-A16-Z04	○	40	4	16	40	14				2508-M10x30
AFM90-LN1506-D050-A22-Z05	○	50	5	22	40	14				2510-M12x35
AFM90-LN1506-D063-A22-Z06	○	63	6	22	40	14				2514-M16x35
AFM90-LN1506-D080-A27-Z07	○	80	7	27	50	14				-
AFM90-LN1607-D050-A22-Z03-H	●	50	3	22	40	16	LNHT 1607..	4420-M5x14	80-T20	2508-M10x30
AFM90-LN1607-D063-A22-Z04	○	63	4	22	40	16				2510-M12x35
AFM90-LN1607-D080-A27-Z05	○	80	5	27	50	16				2514-M16x35
AFM90-LN1607-D100-A32-Z06-H	●	100	6	32	50	16				-

R: Sağ/Right L: Sol/Left ● Stokta/In Stock ○ Stokta Yok/Non Stock Item  
ISCR Ucuna Uygundur. / Compatible with ISCR Insert.

Sipariş Örneği/Ordering Example : 1 ad./pcs. AFM90-LN1106-D050-A22-Z05  
Kesme Hesabı : S 271 / Cutting Calculation : P 271  
Montaj Ölçüleri : S 269 / Mounting Reference : P 269

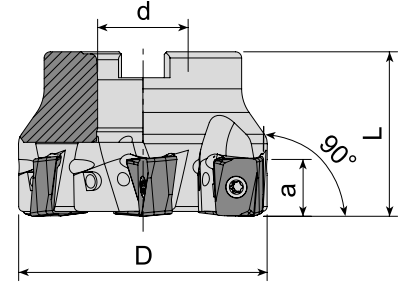

Takım Kodu Ordering Code	Stok Stock	Takım Ölçüleri (mm) Dimension (mm)					Kesici Uç Insert	Yedek Parçaları Spare Parts		
		D	Z	d	L	a		Sıkma Vidası Screw	Tork Anahtar Torx Key	Montaj Vidası Mounting Screw
AFM90-LN1307-D050-A22-Z04-H	●	50	4	22	40	13	LNKX 1307..	1315-M4x11	80-T15	2508-M10x30
AFM90-LN1307-D063-A22-Z06-H	●	63	6	22	40	13				2510-M12x35
AFM90-LN1307-D080-A27-Z07-H	●	80	7	27	50	13				2514-M16x35
AFM90-LN1307-D100-A32-Z08-H	●	100	8	32	50	13				-

WLTR Ucuna Uygunudur. / Compatible with WLTR Insert.

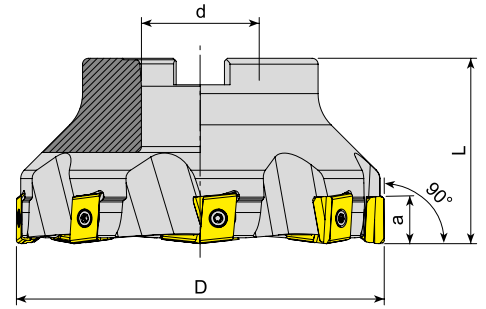

Takım Kodu Ordering Code	Stok Stock	Takım Ölçüleri (mm) Dimension (mm)					Kesici Uç Insert	Yedek Parçaları Spare Parts		
		D	Z	d	L	a		Sıkma Vidası Screw	Tork Anahtar Torx Key	Montaj Vidası Mounting Screw
AFM90-LN15Z-D050-A22-Z04	●	50	4	22	40	15	LNKT 1506..	1515-M4x11	80-T15	2508-M10x30
AFM90-LN15Z-D063-A22-Z05	●	63	5	22	40	15				2510-M12x35
AFM90-LN15Z-D080-A27-Z06	●	80	6	27	50	15				2514-M16x35
AFM90-LN15Z-D100-A32-Z07	●	100	7	32	50	15				-
AFM90-LN15Z-D125-B40-Z08	●	125	8	40	63	15				-

R: Sağ/Right L: Sol/Left ● Stokta/In Stock ○ Stokta Yok/Non Stock Item  
ZCC Ucuna Uygunudur. / Compatible with ZCC Insert.

Sipariş Örneği/Ordering Example : 1 ad./pcs. AFM90-LN1307-D050-A22-Z04-H  
Kesme Hesabı : S 271 / Cutting Calculation : P 271  
Montaj Ölçüleri : S 269 / Mounting Reference : P 269

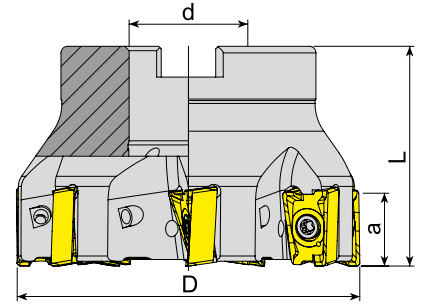

Takım Kodu Ordering Code	Stok Stock	Takım Ölçüleri (mm) Dimension (mm)					Kesici Uç Insert	Yedek Parçaları Spare Parts		
		D	Z	d	L	a		Sıkma Vidası Screw	Tork Anahtar Torx Key	Montaj Vidası Mounting Screw
AFM90-LN15T6-D050-A22-Z05-H	●	50	5	22	40	15.5	LNGU 15T6..	4015-M4x12	80-T15	2508-M10x30
AFM90-LN15T6-D063-A22-Z06-H	●	63	6	22	40	15.5				2510-M12x35
AFM90-LN15T6-D080-A27-Z07-H	●	80	7	27	50	15.5				

KNMTL Ucuna Uygunudur. / Compatiple with KNMTL Insert.

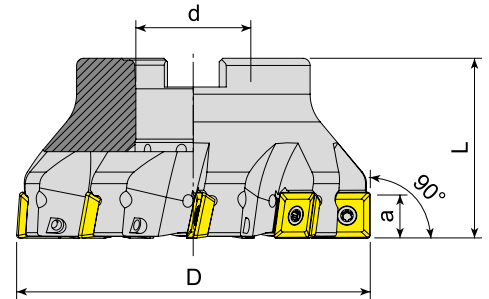

Takım Kodu Ordering Code	Stok Stock	Takım Ölçüleri (mm) Dimension (mm)					Kesici Uç Insert	Yedek Parçaları Spare Parts		
		D	Z	d	L	a		Sıkma Vidası Screw	Tork Anahtar Torx Key	Montaj Vidası Mounting Screw
AFM90-R290.12-D050-A22-Z04-H	●	50	4	22	40	10.7	R290-12T3..	4015-M3.5x11	80-T15	2508-M10x30
AFM90-R290.12-D063-A22-Z05-H	●	63	5	22	40	10.7				2510-M12x35
AFM90-R290.12-D080-A27-Z07-H	●	80	7	27	50	10.7				2514-M16x35
AFM90-R290.12-D100-A32-Z09-H	●	100	9	32	50	10.7				-
AFM90-R290.12-D125-B40-Z11	●	125	11	40	63	10.7				

R: Sağ/Right L: Sol/Left ● Stokta/In Stock ○ Stokta Yok/Non Stock Item  
SNDVK Ucuna Uygunudur. / Compatiple with SNDVK Insert.

Sipariş Örneği/Ordering Example : 1 ad./pcs. AFM90-LN15T6-D050-A22-Z05-H  
Kesme Hesabı : S 271 / Cutting Calculation : P 271  
Montaj Ölçüleri : S 269 / Mounting Reference : P 269

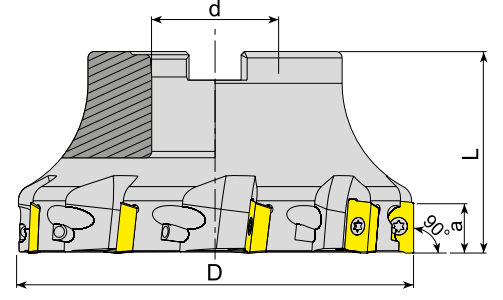

Takım Kodu Ordering Code	Stok Stock	Takım Ölçüleri (mm) Dimension (mm)					Kesici Uç Insert	Yedek Parçaları Spare Parts		
		D	Z	d	L	a		Sıkma Vidası Screw	Tork Anahtar Torx Key	Montaj Vidası Mounting Screw
AFM90-R390.11-D040-A16-Z05-H	●	40	5	16	40	10	R390-11T3..	3008-M2.5x6	80-T08	2506-M8x30
AFM90-R390.11-D050-A22-Z06-H	●	50	6	22	40	10				2508-M10x30
AFM90-R390.11-D063-A22-Z07-H	●	63	7	22	40	10				2510-M12x35
AFM90-R390.11-D080-A27-Z09-H	●	80	9	27	50	10				-
AFM90-R390.17-D040-A16-Z04-H	●	40	4	16	40	15.4	R390-1704..	4015-M3.5x11	80-T15	2506-M8x30
AFM90-R390.17-D050-A22-Z05-H	●	50	5	22	40	15.4				2508-M10x30
AFM90-R390.17-D063-A22-Z06-H	●	63	6	22	40	15.4				2510-M12x35
AFM90-R390.17-D080-A27-Z07-H	●	80	7	27	50	15.4				2514-M16x35
AFM90-R390.17-D100-A32-Z08-H	●	100	8	32	50	15.4				-
AFM90-R390.17-D125-B40-Z09	●	125	9	40	63	15.4				-
AFM90-R390.18-D050-A22-Z04-H	●	50	4	22	40	15.4	R390-1806..	1515-M4x11		2508-M10x30
AFM90-R390.18-D063-A22-Z05-H	●	63	5	22	40	15.4				2510-M12x35
AFM90-R390.18-D080-A27-Z06-H	●	80	6	27	50	15.4				2514-M16x35
AFM90-R390.18-D100-A32-Z07-H	●	100	7	32	50	15.4				-
AFM90-R390.18-D125-B40-Z08	●	125	8	40	63	15.4				-

SNDVK Ucuna Uygunudur. / Compatible with SNDVK Insert.

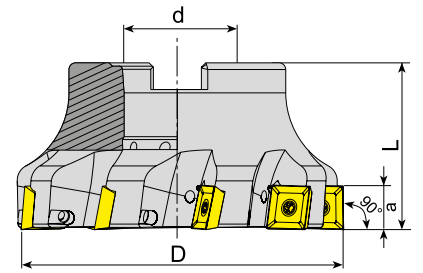

Takım Kodu Ordering Code	Stok Stock	Takım Ölçüleri (mm) Dimension (mm)					Kesici Uç Insert	Yedek Parçaları Spare Parts		
		D	Z	d	L	a		Sıkma Vidası Screw	Tork Anahtar Torx Key	Montaj Vidası Mounting Screw
AFM90-490R14-D050-A22-Z04-H	●	50	4	22	40	10	490R-1404..	4015-M3.5x11	80-T15	2508-M10x30
AFM90-490R14-D063-A22-Z05-H	●	63	5	22	40	10				2510-M12x35
AFM90-490R14-D080-A27-Z07-H	●	80	7	27	50	10				-

R: Sağ/Right L: Sol/Left ● Stokta/In Stock ○ Stokta Yok/Non Stock Item  
SNDVK Ucuna Uygunudur. / Compatible with SNDVK Insert.

Sipariş Örneği/Ordering Example : 1 ad./pcs. AFM90-R390.11-D040-A16-Z05-H  
Kesme Hesabı : S 271 / Cutting Calculation : P 271  
Montaj Ölçüleri : S 269 / Mounting Reference : P 269

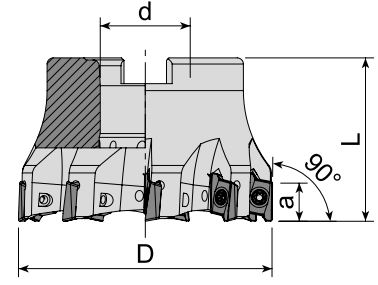

Takım Kodu Ordering Code	Stok Stock	Takım Ölçüleri (mm) Dimension (mm)					Kesici Uç Insert	Yedek Parçaları Spare Parts		
		D	Z	d	L	a		Sıkma Vidası Screw	Tork Anahtar Torx Key	Montaj Vidası Mounting Screw
AFM90-RT10-D040-A16-Z06-H	●	40	6	16	40	10	RT 1003..	3008-M2.5x6	80-T08	2506-M8x30
AFM90-RT10-D050-A22-Z07-H	●	50	7	22	40	10				2407-M10x30
AFM90-RT10-D063-A22-Z09-H	●	63	9	22	40	10				

SFTY Ucuna Uygundur. / Compatible with SFTY Insert.

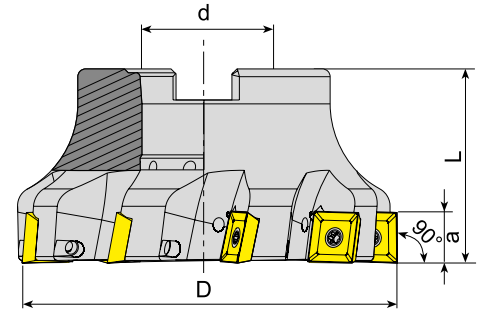

Takım Kodu Ordering Code	Stok Stock	Takım Ölçüleri (mm) Dimension (mm)					Kesici Uç Insert	Yedek Parçaları Spare Parts		
		D	Z	d	L	a		Sıkma Vidası Screw	Tork Anahtar Torx Key	Montaj Vidası Mounting Screw
AFM90-SD09M4-D040-A16-Z04-H	●	40	4	16	40	9	SD.. 09M4..	4015-M3.5x11	80-T15	2406-M8x30
AFM90-SD09M4-D050-A22-Z05-H	●	50	5	22	40	9				2508-M10x30
AFM90-SD09M4-D063-A22-Z06-H	●	63	6	22	40	9				
AFM90-SD1305-D050-A22-Z04-H	●	50	4	22	40	13	SD.. 1305..	1020-M5x11	80-T20	2408-M10x30
AFM90-SD1305-D063-A22-Z05-H	●	63	5	22	40	13				2508-M10x30
AFM90-SD1305-D080-A27-Z06-H	●	80	6	27	50	13				2510-M12x35
AFM90-SD1305-D100-A32-Z07-H	●	100	7	32	50	13				2514-M16x35
AFM90-SD1305-D125-B40-Z08	●	125	8	40	63	13				-
AFM90-SD1305-D160-C40-Z10	●	160	10	40	63	13				

R: Sağ/Right L: Sol/Left ● Stokta/In Stock ○ Stokta Yok/Non Stock Item  
KRLY Ucuna Uygundur. / Compatible with KRLY Insert.

Sipariş Örneği/Ordering Example : 1 ad./pcs. AFM90-RT10-D040-A16-Z06-H  
Kesme Hesabı : S 271 / Cutting Calculation : P 271  
Montaj Ölçüleri : S 269 / Mounting Reference : P 269

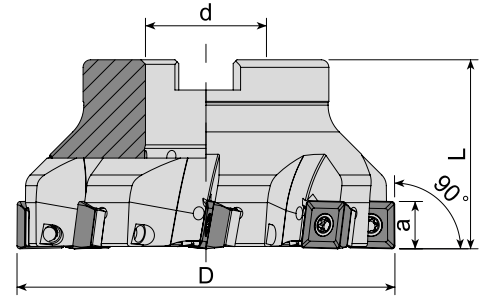

Takım Kodu Ordering Code	Stok Stock	Takım Ölçüleri (mm) Dimension (mm)					Kesici Uç Insert	Yedek Parçaları Spare Parts				
		D	Z	d	L	a		Altık Screw	Altık Vidası Wedge Clamp	Sıkma Vidası Screw	Tork Anahtar Torx Key	Montaj Vidası Mounting Screw
AFM90S-SD1204-D050-A22-Z04-H	●	50	4	22	40	11	SDMT 1204..	AASD-3-0001	AAV-06-M3.5x11	4015-M3.5x14	80-T15	2408-M10x30
AFM90S-SD1204-D063-A22-Z05-H	●	63	5	22	40	11						2508-M10x30
AFM90S-SD1204-D080-A27-Z06-H	●	80	6	27	50	11						2510-M12x35
AFM90S-SD1204-D100-A32-Z08-H	●	100	8	32	50	11						2514-M16x35
AFM90S-SD1204-D125-B40-Z10	●	125	10	40	63	11						-
AFM90S-SD1204-D160-C40-Z12	●	160	12	40	63	11						-

DJT Ucuna Uygunudur. / Compatible with DJT Insert.

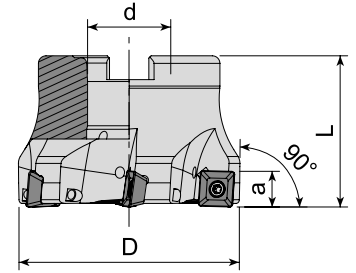

Takım Kodu Ordering Code	Stok Stock	Takım Ölçüleri (mm) Dimension (mm)					Kesici Uç Insert	Yedek Parçaları Spare Parts		
		D	Z	d	L	a		Sıkma Vidası Screw	Tork Anahtar Torx Key	Montaj Vidası Mounting Screw
AFM90-SE09-D040-A16-Z04-H	●	40	4	16	40	6.7	SEET 09T3..	1008-M3x8	80-T08	2506-M8x30
AFM90-SE09-D050-A22-Z05-H	●	50	5	22	40	6.7				2508-M10x30
AFM90-SE09-D063-A22-Z06-H	●	63	6	22	40	6.7				-

R: Sağ/Right L: Sol/Left ● Stokta/In Stock ○ Stokta Yok/Non Stock Item  
ZCC Ucuna Uygunudur. / Compatible with ZCC Insert.

Sipariş Örneği/Ordering Example : 1 ad./pcs. AFM90S-SD1204-D050-A22-Z04-H  
Kesme Hesabı : S 271 / Cutting Calculation : P 271  
Montaj Ölçüleri : S 269 / Mounting Reference : P 269

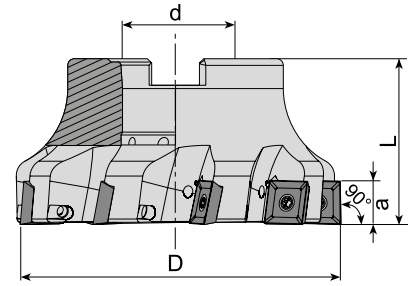

Takım Kodu Ordering Code	Stok Stock	Takım Ölçüleri (mm) Dimension (mm)					Kesici Uç Insert	Yedek Parçaları Spare Parts		
		D	Z	d	L	a		Sıkma Vidası Screw	Tork Anahtar Torx Key	Montaj Vidası Mounting Screw
AFM90-SE12-D050-A22-Z04-H	●	50	4	22	40	12	SEET 1203..	4015-M3.5x11	80-T15	2508-M10x30 2510-M12x35 2514-M16x35 -
AFM90-SE12-D063-A22-Z05-H	●	63	5	22	40	12				
AFM90-SE12-D080-A27-Z07-H	●	80	7	27	50	12				
AFM90-SE12-D100-A32-Z09-H	●	100	9	32	50	12				
AFM90-SE12-D125-B40-Z11	●	125	11	40	63	12				

ZCC Ucuna Uygundur. / Compatible with ZCC Insert.

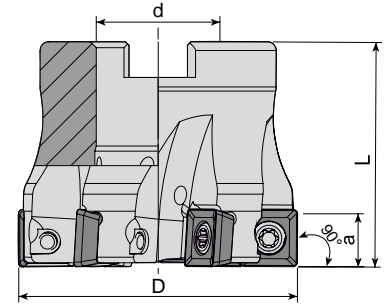

Takım Kodu Ordering Code	Stok Stock	Takım Ölçüleri (mm) Dimension (mm)					Kesici Uç Insert	Yedek Parçaları Spare Parts		
		D	Z	d	L	a		Sıkma Vidası Screw	Tork Anahtar Torx Key	Montaj Vidası Mounting Screw
AFM90-SP1004-D040-A16-Z04-H	●	40	4	16	40	9.4	SPMT 1004.. XPMT 1004.. QPMR 1004.. QPMT 1004..	4015-M4x10	80-T15	2506-M8x30 2508-M10x30
AFM90-SP1004-D050-A22-Z06-H	●	50	6	22	40	9.4				

R: Sağ/Right L: Sol/Left ● Stokta/In Stock ○ Stokta Yok/Non Stock Item  
ISCR Ucuna Uygundur. / Compatible with ISCR Insert.

Sipariş Örneği/Ordering Example : 1 ad./pcs. AFM90-SE12-D050-A22-Z04-H  
Kesme Hesabı : S 271 / Cutting Calculation : P 271  
Montaj Ölçüleri : S 269 / Mounting Reference : P 269

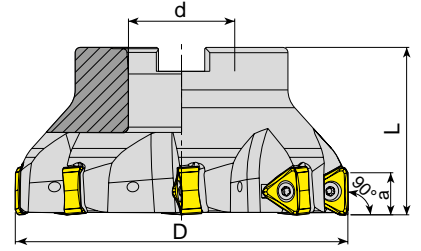

Takım Kodu Ordering Code	Stok Stock	Takım Ölçüleri (mm) Dimension (mm)					Kesici Uç Insert	Yedek Parçaları Spare Parts		
		D	Z	d	L	a		Sıkma Vidası Screw	Tork Anahtar Torx Key	Montaj Vidası Mounting Screw
AFM90-TN2207-D063-A22-Z04-H	●	63	4	22	40	15	TN.X 2207..			2508-M10x30
AFM90-TN2207-D080-A27-Z05-H	●	80	5	27	50	15				2510-M12x35
AFM90-TN2207-D100-B32-Z06	●	100	6	32	50	15				-
AFM90-TN2207-D125-B40-Z08	●	125	8	40	63	15				-

TGTC Ucuna Uygundur. / Compatiple with TGTC Insert.

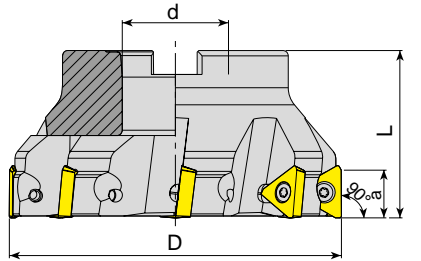

Takım Kodu Ordering Code	Stok Stock	Takım Ölçüleri (mm) Dimension (mm)					Kesici Uç Insert	Yedek Parçaları Spare Parts		
		D	Z	d	L	a		Sıkma Vidası Screw	Tork Anahtar Torx Key	Montaj Vidası Mounting Screw
AFM90-TP2205-D063-A22-Z04	●	63	4	22	40	18	TPKT 2205..			2508-M10x30
AFM90-TP2205-D080-A27-Z06	●	80	6	27	50	18				2510-M12x35
AFM90-TP2205-D100-A32-Z07	●	100	7	32	50	18				2514-M16x35
AFM90-TP2205-D125-B40-Z08	●	125	8	40	63	18				-
AFM90-TP2205-D160-C40-Z09	●	160	9	40	63	18				-
AFM90-TP2205-D200-C60-Z12	●	200	12	60	63	18				-

R: Sağ/Right L: Sol/Left ● Stokta/In Stock ○ Stokta Yok/Non Stock Item  
TGTC Ucuna Uygundur. / Compatiple with TGTC Insert.

Sipariş Örneği/Ordering Example : 1 ad./pcs. AFM90-TN2207-D063-A22-Z04-H  
Kesme Hesabı : S 271 / Cutting Calculation : P 271  
Montaj Ölçüleri : S 269 / Mounting Reference : P 269



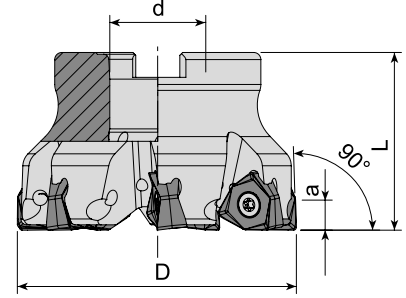

Takım Kodu Ordering Code	Stok Stock	Takım Ölçüleri (mm) Dimension (mm)					Kesici Uç Insert	Yedek Parçaları Spare Parts		
		D	Z	d	L	a		Sıkma Vidası Screw	Tork Anahtar Torx Key	Montaj Vidası Mounting Screw
AFM90-WN0806-D050-A16-Z04-H	●	50	4	16	40	8	WMMX 080608			2506-M8x30
AFM90-WN0806-D063-A22-Z05-H	●	63	5	22	40	8				2508-M10x30
AFM90-WN0806-D080-A27-Z07-H	●	80	7	27	50	8				2510-M12x35

KYCR-JD Ucuna Uygun. / Compatible with KYCR-JD Insert.

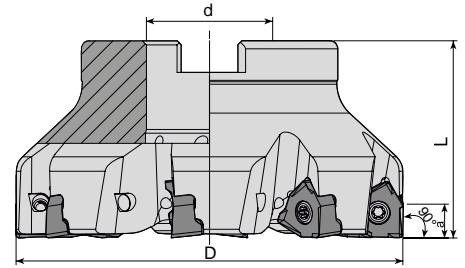

Takım Kodu Ordering Code	Stok Stock	Takım Ölçüleri (mm) Dimension (mm)					Kesici Uç Insert	Yedek Parçaları Spare Parts		
		D	Z	d	L	a		Sıkma Vidası Screw	Tork Anahtar Torx Key	Montaj Vidası Mounting Screw
AFM90-XN0806-D050-A22-Z04-H	●	50	4	22	40	7.5	XNEX 0806..			2508-M10x30
AFM90-XN0806-D063-A22-Z05-H	●	63	5	22	40	7.5				2510-M12x35
AFM90-XN0806-D080-A27-Z07-H	●	80	7	27	50	7.5				2514-M16x35
AFM90-XN0806-D100-A32-Z08-H	●	100	8	32	50	7.5				

R: Sağ/Right L: Sol/Left ● Stokta/In Stock ○ Stokta Yok/Non Stock Item  
SC Ucuna Uygun. / Compatible with SC Insert.

Sipariş Örneği/Ordering Example : 1 ad./pcs. AFM90-WN0806-D050-A16-Z04-H  
Kesme Hesabı : S 271 / Cutting Calculation : P 271  
Montaj Ölçüleri : S 269 / Mounting Reference : P 269

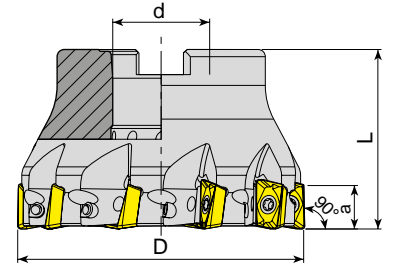

Takım Kodu Ordering Code	Stok Stock	Takım Ölçüleri (mm) Dimension (mm)					Kesici Uç Insert	Yedek Parçaları Spare Parts		
		D	Z	d	L	a		Sıkma Vidası Screw	Tork Anahtar Torx Key	Montaj Vidası Mounting Screw
AFM90-X012-D040-A16-Z05-H	●	40	5	16	40	11	XO.. 1204..			2506-M8x30
AFM90-X012-D050-A22-Z07-H	●	50	7	22	40	11				2508-M10x30
AFM90-X012-D063-A22-Z08-H	●	63	8	22	40	11				2510-M12x35
AFM90-X012-D080-A27-Z10-H	●	80	10	27	50	11				2514-M16x35
AFM90-X012-D100-A32-Z12-H	●	100	12	32	50	11				

SC Ucuna Uygundur. / Compatible with SC Insert.

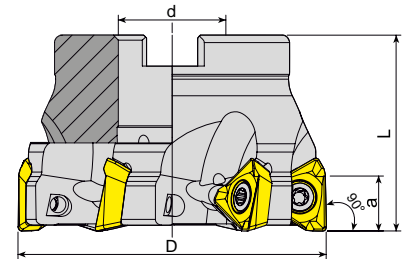

Takım Kodu Ordering Code	Stok Stock	Takım Ölçüleri (mm) Dimension (mm)					Kesici Uç Insert	Yedek Parçaları Spare Parts		
		D	Z	d	L	a		Sıkma Vidası Screw	Tork Anahtar Torx Key	Montaj Vidası Mounting Screw
AFM90-3P1004-D040-A16-Z05-H	●	40	5	16	40	7	3PKT 1004..			2506-M8x30
AFM90-3P1004-D050-A22-Z06-H	●	50	6	22	40	7				2508-M10x30
AFM90-3P1505-D050-A22-Z04-H	●	50	4	22	40	11	3PKT 1505..			2508-M10x30
AFM90-3P1505-D050-A22-Z05-H	●	50	5	22	40	11				2510-M12x35
AFM90-3P1505-D063-A22-Z04-H	●	63	4	22	40	11				2514-M16x35
AFM90-3P1505-D063-A22-Z06-H	●	63	6	22	40	11				

R: Sağ/Right L: Sol/Left ● Stokta/In Stock ○ Stokta Yok/Non Stock Item  
TGTC Ucuna Uygundur. / Compatible with TGTC Insert.

Sipariş Örneği/Ordering Example : 1 ad./pcs. AFM90-X012-D040-A16-Z05-H  
Kesme Hesabı : S 271 / Cutting Calculation : P 271  
Montaj Ölçüleri : S 269 / Mounting Reference : P 269

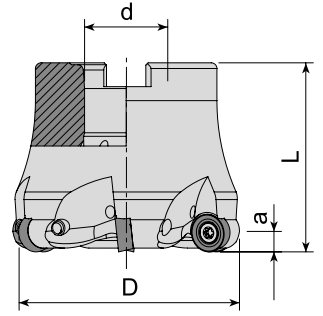

Takım Kodu Ordering Code	Stok Stock	Takım Ölçüleri (mm) Dimension (mm)					Kesici Uç Insert	Yedek Parçaları Spare Parts				
		D	Z	d	L	a		Sıkma Vidası Screw	Tork Anahtar Torx Key	Montaj Vidası Mounting Screw		
AFMR-RC10T3-D040-A16-Z04-H	●	40	4	16	40	5	RC.. 10T3..			2406-M8x30		
AFMR-RC10T3-D050-A22-Z05-H	●	50	5	22	50	5				1515-M4x11	80-T15	2508-M10x30
AFMR-RC10T3-D063-A22-Z06-H	●	63	6	22	50	5						

ZCC Ucuna Uygundur. / Compatible with ZCC Insert.

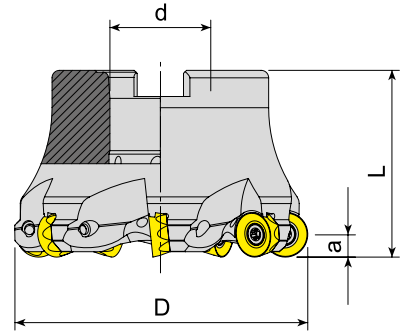

Takım Kodu Ordering Code	Stok Stock	Takım Ölçüleri (mm) Dimension (mm)					Kesici Uç Insert	Yedek Parçaları Spare Parts				
		D	Z	d	L	a		Sıkma Vidası Screw	Tork Anahtar Torx Key	Montaj Vidası Mounting Screw		
AFMR-RC1204-D040-A16-Z04-H	●	40	4	16	40	6	RC.. 1204..			2506-M8x30		
AFMR-RC1204-D052-A22-Z05-H	●	52	5	22	50	6				4015-M3.5x11	80-T15	2508-M10x30
AFMR-RC1204-D050-A22-Z05-H	●	50	5	22	50	6						2510-M12x35
AFMR-RC1204-D063-A22-Z06-H	●	63	6	22	50	6						
AFMR-RC1204-D080-A27-Z07-H	●	80	7	27	50	6						

R: Sağ/Right L: Sol/Left ● Stokta/In Stock ○ Stokta Yok/Non Stock Item  
SNDVK Ucuna Uygundur. / Compatible with SNDVK Insert.

Sipariş Örneği/Ordering Example : 1 ad./pcs. AFMR-RC10T3-D040-A16-Z04-H  
Kesme Hesabı : S 271 / Cutting Calculation : P 271  
Montaj Ölçüleri : S 269 / Mounting Reference : P 269

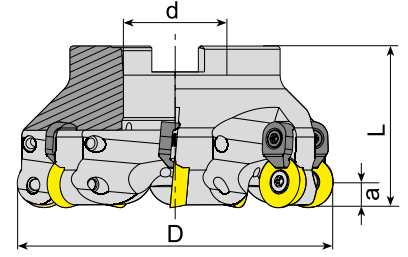

Takım Kodu Ordering Code	Stok Stock	Takım Ölçüleri (mm) Dimension (mm)					Kesici Uç Insert	Yedek Parçaları Spare Parts				
		D	Z	d	L	a		Sıkma Vidası Screw	Baskı Parçası Wedge Clamp	Baskı Vidası Clamp Screw	Tork Anahtar Torx Key	Montaj Vidası Mounting Screw
AFMR-RD0702-D050-A22-Z06-H	●	50	6	22	40	3.5	RD.. 0702..	3008-M2.5x6	-	-	80-T08	2407-M10x30
AFMR-RD0803-D050-A22-Z05-H	●	50	5	22	40	4	RD.. 0803..	1008-M3x8	-	-	80-T08	2407-M10x30
AFMRC-RD1003-D040-A16-Z04-H	●	40	4	16	40	5	RD.. 1003..					2406-M8x30
AFMRC-RD1003-D050-A22-Z05-H	●	50	5	22	50	5						2508-M10x30
AFMRC-RD1003-D063-A22-Z06-H	●	63	6	22	50	5						2510-M12x35
AFMRC-RD1003-D080-A27-Z07-H	●	80	7	27	50	5						2514-M16x35
AFMRC-RD1003-D100-A32-Z08-H	●	100	8	32	50	5						2508-M10x30
AFMRC-RD10T3-D050-A22-Z05-H	●	50	5	22	50	5	RD.. 10T3..					2406-M8x30
AFMRC-RD10T3-D063-A22-Z06-H	●	63	6	22	50	5						2508-M10x30
AFMRC-RD12T3-D040-A16-Z04-H	●	40	4	16	40	6	RD.. 12T3..	4015-M3.5x11	ACK-15	1015-M3.5x11	80-T15	2508-M10x30
AFMRC-RD12T3-D050-A22-Z05-H	●	50	5	22	50	6						2510-M12x35
AFMRC-RD12T3-D052-A22-Z05-H	●	52	5	22	50	6						2514-M16x35
AFMRC-RD12T3-D063-A22-Z06-H	●	63	6	22	50	6						-
AFMRC-RD12T3-D080-A27-Z07-H	●	80	7	27	50	6						2406-M8x30
AFMRC-RD12T3-D100-A32-Z08-H	●	100	8	32	50	6						2508-M10x30
AFMRC-RD12T3-D125-B40-Z09	●	125	9	40	63	6						2510-M12x35
AFMRC-RD1204-D040-A16-Z04-H	●	40	4	16	40	6	RD.. 1204..					2514-M16x35
AFMRC-RD1204-D050-A22-Z05-H	●	50	5	22	50	6						2508-M10x30
AFMRC-RD1204-D052-A22-Z05-H	●	52	5	22	50	6						2510-M12x35
AFMRC-RD1204-D063-A22-Z06-H	●	63	6	22	50	6						2514-M16x35
AFMRC-RD1204-D080-A27-Z07-H	●	80	7	27	50	6						-
AFMRC-RD1204-D100-A32-Z07-H	●	100	7	32	50	6						2408-M10x30
AFMRC-RD1204-D100-A32-Z08-H	●	100	8	32	50	6						2508-M10x30
AFMRC-RD1604-D050-A22-Z04-H	●	50	4	22	50	8	RD.. 1604..	1515-M4.5x11	ACK-05	1515-M4x11		2510-M12x35
AFMRC-RD1604-D052-A22-Z04-H	●	52	4	22	50	8						2514-M16x35
AFMRC-RD1604-D063-A22-Z05-H	●	63	5	22	50	8						-
AFMRC-RD1604-D066-A22-Z05-H	●	66	5	22	50	8						2408-M10x30
AFMRC-RD1604-D066-A27-Z05-H	●	66	5	27	50	8						2508-M10x30
AFMRC-RD1604-D080-A27-Z06-H	●	80	6	27	50	8						2510-M12x35
AFMRC-RD1604-D100-A32-Z07-H	●	100	7	32	50	8						2514-M16x35
AFMRC-RD1604-D125-B40-Z07	●	125	7	40	63	8	-					

R: Sağ/Right L: Sol/Left ● Stokta/In Stock ○ Stokta Yok/Non Stock Item  
ISO Ucuna Uygundur. / Compatible with ISO Insert.

Sipariş Örneği/Ordering Example : 1 ad./pcs. AFMR-RD0702-D050-A22-Z06-H

Kesme Hesabı : S 271 / Cutting Calculation : P 271

Montaj Ölçüleri : S 269 / Mounting Reference : P 269



www.akkо.com.tr

Дистрибьютер ООО "Ресурс Плюс"  
+7 (351) 247-74-40; info@rp-ural.ru

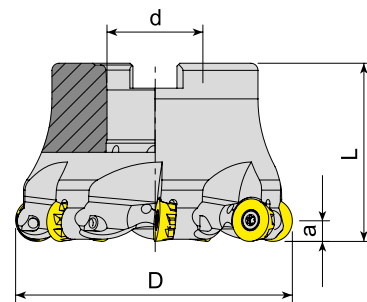

Takım Kodu Ordering Code	Stok Stock	Takım Ölçüleri (mm) Dimension (mm)					Kesici Uç Insert	Yedek Parçaları Spare Parts		
		D	Z	d	L	a		Sıkma Vidası Screw	Tork Anahtar Torx Key	Montaj Vidası Mounting Screw
AFMR-RP10T3-D063-A22-Z06-H	●	63	6	22	40	5	RPNX 10T3..	4010-M3x8	80-T10	2508-M10x30
AFMR-RP10T3-D080-A27-Z07-H	●	80	7	27	50	5				2510-M12x35
AFMR-RP1204-D040-A16-Z04-H	●	40	4	16	40	6	RPNX 1204..	4015-M3.5x11	80-T15	2406-M8x30
AFMR-RP1204-D080-A27-Z07-H	●	80	7	27	50	6				2510-M12x35

CRTZT Ucuna Uygun. / Compatible with CRTZT Insert.

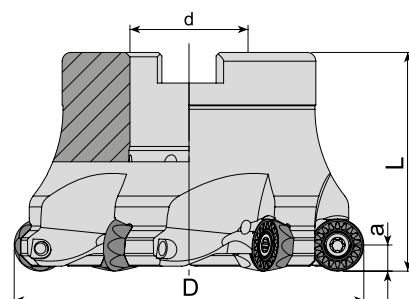

Takım Kodu Ordering Code	Stok Stock	Takım Ölçüleri (mm) Dimension (mm)					Kesici Uç Insert	Yedek Parçaları Spare Parts		
		D	Z	d	L	a		Sıkma Vidası Screw	Tork Anahtar Torx Key	Montaj Vidası Mounting Screw
AFMR-RP1204M-D050-A22-Z04-H	●	50	4	22	50	6	RPMT 1204..	4015-M4x11	80-T15	2508-M10x30
AFMR-RP1204M-D052-A22-Z05-H	●	52	5	22	50	6				2510-M12x35
AFMR-RP1204M-D063-A22-Z05-H	●	63	5	22	50	6				
AFMR-RP1204M-D080-A27-Z06-H	●	80	6	27	50	6				

R: Sağ/Right L: Sol/Left ● Stokta/In Stock ○ Stokta Yok/Non Stock Item  
MTSBH Ucuna Uygun. / Compatible with MTSBH Insert.

Sipariş Örneği/Ordering Example : 1 ad./pcs. AFMR-RP10T3-D063-A22-Z06-H

Kesme Hesabı : S 271 / Cutting Calculation : P 271

Montaj Ölçüleri : S 269 / Mounting Reference : P 269

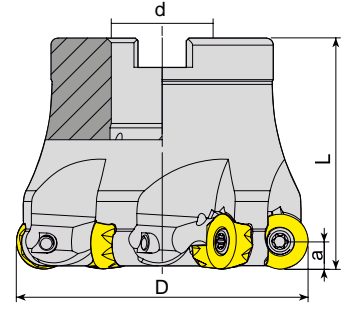

Takım Kodu Ordering Code	Stok Stock	Takım Ölçüleri (mm) Dimension (mm)					Kesici Uç Insert	Yedek Parçaları Spare Parts		
		D	Z	d	L	a		Sıkma Vidası Screw	Tork Anahtar Torx Key	Montaj Vidası Mounting Screw
AFMR-RY10-D040-A16-Z04-H	●	40	4	16	40	5	RYMX 1004..	4015-M3.5x8	80-T15	2406-M8x30
AFMR-RY10-D050-A22-Z05-H	●	50	5	22	50	5				2508-M10x30
AFMR-RY10-D063-A22-Z06-H	●	63	6	22	50	5				2406-M8x30
AFMR-RY12-D040-A16-Z04-H	●	40	4	16	40	6	RYMX 1205..	4015-M4x11	80-T15	2406-M8x30
AFMR-RY12-D050-A22-Z05-H	●	50	5	22	50	6				2508-M10x30
AFMR-RY12-D052-A22-Z05-H	●	52	5	22	50	6				2406-M8x30
AFMR-RY12-D063-A22-Z06-H	●	63	6	22	50	6				2508-M10x30

TGTC Ucuna Uygundur. / Compatiple with TGTC Insert.

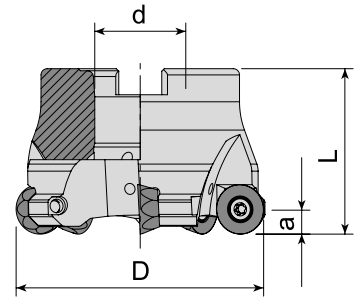

Takım Kodu Ordering Code	Stok Stock	Takım Ölçüleri (mm) Dimension (mm)					Kesici Uç Insert	Yedek Parçaları Spare Parts		
		D	Z	d	L	a		Sıkma Vidası Screw	Tork Anahtar Torx Key	Montaj Vidası Mounting Screw
AFMR-QP10T3-D040-A16-Z04-H	●	40	4	16	40	5	QP.. 10T3..	4015-M3.5x11	80-T15	2506-M8x30
AFMR-QP10T3-D050-A22-Z05-H	●	50	5	22	40	5				2407-M10x30
AFMR-QP10T3-D063-A22-Z06-H	●	63	6	22	40	5				2407-M10x30
AFMR-QP1204-D050-A22-Z04-H	●	50	4	22	40	6	QP.. 1204..	1515-M4x11	80-T15	2407-M10x30
AFMR-QP1204-D063-A22-Z05-H	●	63	5	22	40	6				2407-M10x30

R: Sağ/Right L: Sol/Left ● Stokta/In Stock ○ Stokta Yok/Non Stock Item  
SMTM Ucuna Uygundur. / Compatiple with SMTM Insert.

Sipariş Örneği/Ordering Example : 1 ad./pcs. AFMR-RY10-D040-A16-Z04-H  
Kesme Hesabı : S 271 / Cutting Calculation : P 271  
Montaj Ölçüleri : S 269 / Mounting Reference : P 269

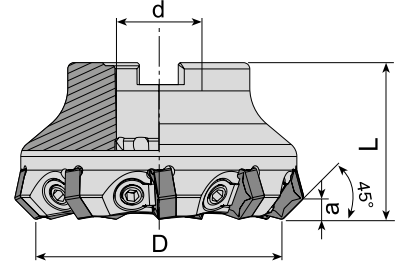

Takım Kodu Ordering Code	Stok Stock	Takım Ölçüleri (mm) Dimension (mm)					Kesici Uç Insert	Yedek Parçaları Spare Parts			
		D	Z	d	L	a		Baskı Pabucu Wedge Clamp	Baskı Vidası Clamp Screw	Anahtar Allen Key	Montaj Vidası Mounting Screw
AFM45C-HN0905-D063-A22-Z07	●	63	7	22	40	4.5	HN.. 0905..	ACK-11	AKV-15-M8x1x20	AAL-05-4	2508-M10x30
AFM45C-HN0905-D080-A27-Z09	●	80	9	27	50	4.5					2510-M12x35
AFM45C-HN0905-D100-A32-Z11	●	100	11	32	50	4.5					2514-M16x35
AFM45C-HN0905-D125-B40-Z13	●	125	13	40	63	4.5					-
AFM45CL-HN0905-D125-B40-Z10	●	125	10	40	63	4.5					-
AFM45C-HN0905-D160-C40-Z15	●	160	15	40	63	4.5					-

WDA-KNMTL Ucuna Uygundur. / Compatible with WDA-KNMTL Insert.

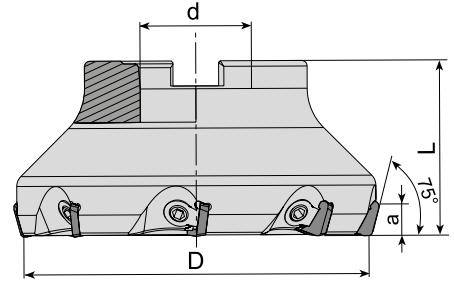

Takım Kodu Ordering Code	Stok Stock	Takım Ölçüleri (mm) Dimension (mm)					Kesici Uç Insert	Yedek Parçaları Spare Parts			
		D	Z	d	L	a		Baskı Pabucu Wedge Clamp	Baskı Vidası Clamp Screw	Anahtar Allen Key	Montaj Vidası Mounting Screw
AFM75C-SP12-D050-A22-Z04	●	50	4	22	42	8	SPKN 1203..	ACK-10	AKV-13-M8x1x16	AAL-05-4	2508-M10x30
AFM75C-SP12-D063-A22-Z05	●	63	5	22	40	8					2510-M12x35
AFM75C-SP12-D080-A27-Z06	●	80	6	27	50	8					2514-M16x35
AFM75C-SP12-D100-A32-Z07	●	100	7	32	50	8					-
AFM75C-SP12-D125-B40-Z08	●	125	8	40	63	8					-
AFM75C-SP12-D160-C40-Z09	●	160	9	40	63	8					-
AFM75C-SP12-D200-C60-Z12	●	200	12	60	63	8					-

R: Sağ/Right L: Sol/Left ● Stokta/In Stock ○ Stokta Yok/Non Stock Item  
ISO Ucuna Uygundur. / Compatible with ISO Insert.

Sipariş Örneği/Ordering Example : 1 ad./pcs. AFM45C-HN0905-D063-A22-Z07  
Kesme Hesabı : S 271 / Cutting Calculation : P 271  
Montaj Ölçüleri : S 269 / Mounting Reference : P 269

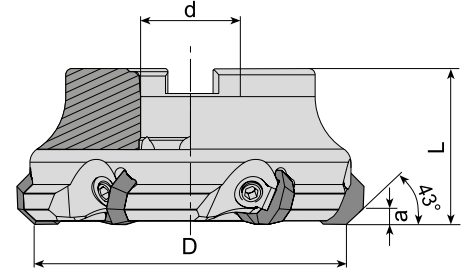

Takım Kodu Ordering Code	Stok Stock	Takım Ölçüleri (mm) Dimension (mm)					Kesici Uç Insert	Yedek Parçaları Spare Parts			
		D	Z	d	L	a		Baskı Pabucu Wedge Clamp	Baskı Vidası Clamp Screw	Anahtar Allen Key	Montaj Vidası Mounting Screw
AFM43C-OF07-D063-A22-Z04	●	63	4	22	45	5	OF.. 0704..	ACK-11	AKV-15-M8x1x20	AAL-05-4	2508-M10x30
AFM43C-OF07-D080-A27-Z05	●	80	5	27	50	5					2510-M12x35
AFM43C-OF07-D100-A32-Z06	●	100	6	32	50	5					2514-M16x35
AFM43C-OF07-D125-B40-Z08	●	125	8	40	63	5					-
AFM43C-OF07-D160-C40-Z09	●	160	9	40	63	5					-

ISO Ucuna Uygundur. / Compatible with ISO Insert.

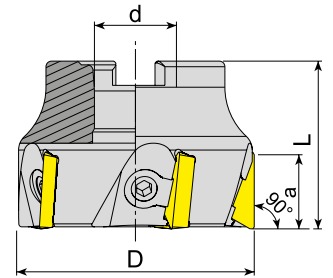

Takım Kodu Ordering Code	Stok Stock	Takım Ölçüleri (mm) Dimension (mm)					Kesici Uç Insert	Yedek Parçaları Spare Parts			
		D	Z	d	L	a		Baskı Pabucu Wedge Clamp	Baskı Vidası Clamp Screw	Anahtar Allen Key	Montaj Vidası Mounting Screw
AFM90C-TP16-D050-A22-Z04	●	50	4	22	40	12	TP.. 1603..	ACK-10	AKV-22-M8x1x14 AKV-13-M8x1x16	AAL-05-4	2407-M10x30
AFM90C-TP16-D063-A22-Z06	●	63	6	22	45	12					2508-M10x30
AFM90C-TP16-D080-A27-Z07	●	80	7	27	50	12					2510-M12x35
AFM90C-TP16-D100-A32-Z08	●	100	8	32	50	12					2514-M16x35
AFM90C-TP16-D125-B40-Z08	●	125	8	40	63	12					-
AFM90C-TP22-D063-A22-Z05	●	63	5	22	45	18	TP.. 2204..	ACK-11	AKV-14-M8x1x18	AAL-05-4	2508-M10x30
AFM90C-TP22-D080-A27-Z06	●	80	6	27	50	18					2510-M12x35
AFM90C-TP22-D100-A32-Z07	●	100	7	32	50	18					2514-M16x35
AFM90C-TP22-D125-B40-Z08	●	125	8	40	63	18					-
AFM90C-TP22-D160-C40-Z09	●	160	9	40	63	18					-
AFM90C-TP22-D200-C60-Z12	●	200	12	60	63	18					-
AFM90C-TP22-D250-C60-Z15	●	250	15	60	63	18					-
AFM90C-TP22-D315-D60-Z18	●	315	18	60	63	18	-				

R: Sağ/Right L: Sol/Left ● Stokta/In Stock ○ Stokta Yok/Non Stock Item  
ISO Ucuna Uygundur. / Compatible with ISO Insert.

Sipariş Örneği/Ordering Example : 1 ad./pcs. AFM43C-OF07-D063-A22-Z04  
Kesme Hesabı : S 271 / Cutting Calculation : P 271  
Montaj Ölçüleri : S 269 / Mounting Reference : P 269





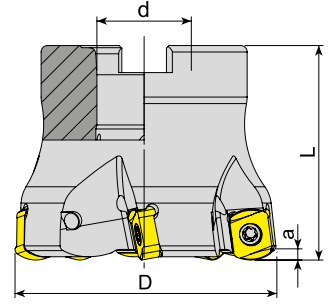

Takım Kodu Ordering Code	Stok Stock	Takım Ölçüleri (mm) Dimension (mm)					Kesici Uç Insert	Yedek Parçaları Spare Parts		
		D	Z	d	L	a		Sıkma Vidası Screw	Tork Anahtar Torx Key	Montaj Vidası Mounting Screw
AHFM-BL0904-D050-A22-Z06-H	●	50	6	22	50	2	BLMP 0904..	1510-M3.5x9	80-T10	2508-M10x30
AHFM-BL0904-D063-A22-Z05-H	●	63	5	22	50	2				
AHFM-BL0904-D063-A22-Z07-H	●	63	7	22	50	2				

TGTC Ucuna Uygun. / Compatible with TGTC Insert.

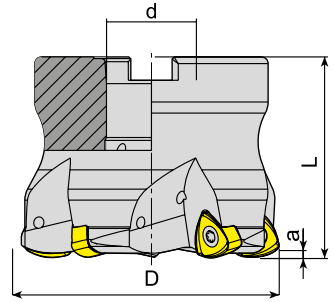

Takım Kodu Ordering Code	Stok Stock	Takım Ölçüleri (mm) Dimension (mm)					Kesici Uç Insert	Yedek Parçaları Spare Parts		
		D	Z	d	L	a		Sıkma Vidası Screw	Tork Anahtar Torx Key	Montaj Vidası Mounting Screw
AHFM-BL1205-D050-A22-Z03-H	●	50	3	22	40	2	BLMP 1205..	1515-M4x11	80-T15	2508-M10x30
AHFM-BL1205-D063-A22-Z04-H	●	63	4	22	40	2				
AHFM-BL1205-D080-A27-Z05-H	●	80	5	27	50	2				2510-M12x35

R: Sağ/Right L: Sol/Left ● Stokta/In Stock ○ Stokta Yok/Non Stock Item  
TGTC Ucuna Uygun. / Compatible with TGTC Insert.

Sipariş Örneği/Ordering Example : 1 ad./pcs. AHFM-BL0904-D050-A22-Z06-H  
Kesme Hesabı : S 271 / Cutting Calculation : P 271  
Montaj Ölçüleri : S 269 / Mounting Reference : P 269

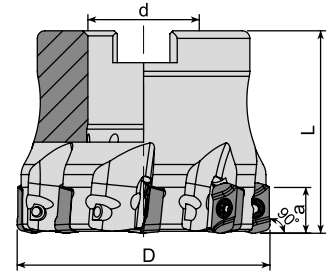

Takım Kodu Ordering Code	Stok Stock	Takım Ölçüleri (mm) Dimension (mm)					Kesici Uç Insert	Yedek Parçaları Spare Parts		
		D	Z	d	L	a		Sıkma Vidası Screw	Tork Anahtar Torx Key	Montaj Vdası Torx Key
AHFM-EP1003-D050-A22-Z08-H	●	50	8	22	40	1				
AHFM-EP1003-D063-A22-Z08-H	●	63	8	22	40	1				

DJT Ucuna Uygundur. / Compatiple with DJT Insert.

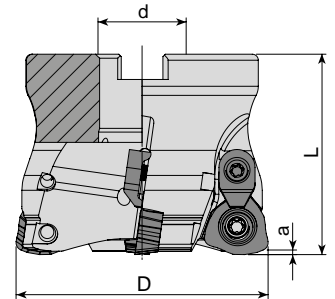

Takım Kodu Ordering Code	Stok Stock	Takım Ölçüleri (mm) Dimension (mm)					Kesici Uç Insert	Yedek Parçaları Spare Parts				
		D	Z	d	L	a		Sıkma Vidası Screw	Baskı Parçası Wedge Clamp	Baskı Vidası Clamp Screw	Tork Anahtar Torx Key	Montaj Vidası Mounting Screw
AHFMC-JD1204-D052-A22-Z03-H	●	52	3	22	50	1.5						
AHFMC-JD1204-D052-A22-Z04-H	●	52	4	22	50	1.5						
AHFMC-JD1405-D052-A22-Z03-H	●	52	3	22	40	2						
AHFMC-JD1405-D063-A22-Z04-H	●	63	4	22	40	2						

R: Sağ/Right L: Sol/Left ● Stokta/In Stock ○ Stokta Yok/Non Stock Item  
MTSBH Ucuna Uygundur. / Compatiple with MTSBH Insert.

Sipariş Örneği/Ordering Example : 1 ad./pcs. AHFM-EP1003-D050-A22-Z08-H  
Kesme Hesabı : S 271 / Cutting Calculation : P 271  
Montaj Ölçüleri : S 269 / Mounting Reference : P 269

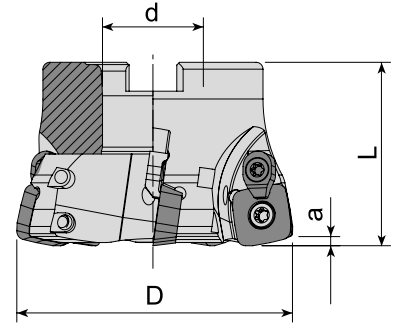

Takım Kodu Ordering Code	Stok Stock	Takım Ölçüleri (mm) Dimension (mm)					Kesici Uç Insert	Yedek Parçaları Spare Parts				
		D	Z	d	L	a		Sıkma Vidası Screw	Baskı Parçası Wedge Clamp	Baskı Vidası Clamp Screw	Tork Anahtar Torx Key	Montaj Vidası Mounting Screw
AHFMC-SD1204-D050-A22-Z04-H	●	50	4	22	40	1.8	SD.. 1204..					
AHFMC-SD1204-D063-A22-Z05-H	●	63	5	22	40	1.8						
AHFMC-SD1204-D080-A27-Z06-H	●	80	6	27	50	1.8						
AHFMC-SD1204-D100-A32-Z08-H	●	100	8	32	50	1.8						

ZCC Ucuna Uygun. / Compatible with ZCC Insert.

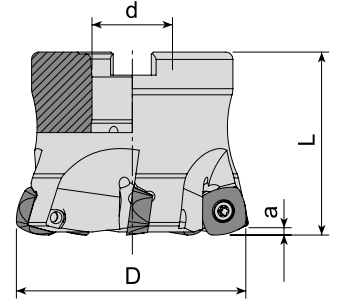



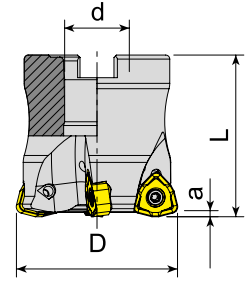

Takım Kodu Ordering Code	Stok Stock	Takım Ölçüleri (mm) Dimension (mm)					Kesici Uç Insert	Yedek Parçaları Spare Parts		
		D	Z	d	L	a		Sıkma Vidası Screw	Tork Anahtar Torx Key	Montaj Vidası Mounting Screw
AHFM-SD1205-D052-A22-Z04-H	●	52	4	22	50	2	SD.. 1205..			
AHFM-SD1205-D052-A22-Z05-H	●	52	5	22	50	2				
AHFM-SD1205-D066-A22-Z05-H	●	66	5	22	50	2				
AHFM-SD1205-D066-A22-Z06-H	●	66	6	22	50	2				
AHFM-SD1205-D080-A27-Z06-H	●	80	6	27	70	2				

R: Sağ/Right L: Sol/Left ● Stokta/In Stock ○ Stokta Yok/Non Stock Item  
HTCH Ucuna Uygun. / Compatible with HTCH Insert.









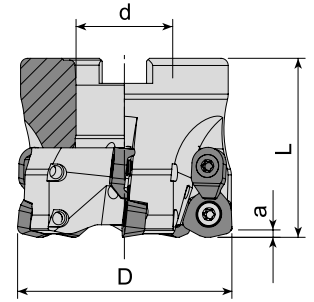



Sipariş Örneği/Ordering Example : 1 ad./pcs. AHFMC-SD1204-D050-A22-Z04-H  
Kesme Hesabı : S 271 / Cutting Calculation : P 271  
Montaj Ölçüleri : S 269 / Mounting Reference : P 269



Takım Kodu Ordering Code	Stok Stock	Takım Ölçüleri (mm) Dimension (mm)					Kesici Uç Insert	Yedek Parçaları Spare Parts			
		D	Z	d	L	a		Sıkma Vidası Screw	Tork Anahtar Torx Key	Montaj Vidası Mounting Screw	
AHFM-WN09T3-D040-A16-Z04-H	●	40	4	16	40	1.5					
AHFML-WN09T3-D040-A16-Z04-H	●	40	4	16	40	1.5					
AHFM-WN09T3-D050-A22-Z05-H	●	50	5	22	40	1.5					
AHFML-WN09T3-D050-A22-Z05-H	●	50	5	22	40	1.5					
AHFM-WN09T3-D063-A22-Z06-H	●	63	6	22	40	1.5					

KRLY Ucuna Uygun. / Compatible with KRLY Insert.

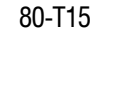

Takım Kodu Ordering Code	Stok Stock	Takım Ölçüleri (mm) Dimension (mm)					Kesici Uç Insert	Yedek Parçaları Spare Parts				
		D	Z	d	L	a		Sıkma Vidası Screw	Baskı Parçası Wedge Clamp	Baskı Vidası Clamp Screw	Tork Anahtar Torx Key	Montaj Vidası Mounting Screw
AHFMC-WD0804-D040-A16-Z04-H	●	40	4	16	40	-						
AHFMC-WD0804-D050-A22-Z04-H	●	50	4	22	50	-						
AHFMC-WD1205-D050-A22-Z04-H	●	50	4	22	50	-						
AHFMC-WD1205-D052-A22-Z04-H	●	52	4	22	50	-						
AHFMC-WD1205-D063-A22-Z05-H	●	63	5	22	50	-						
AHFMC-WD1205-D080-A27-Z06-H	●	80	6	27	63	-						

R: Sağ/Right L: Sol/Left ● Stokta/In Stock ○ Stokta Yok/Non Stock Item  
SMTM Ucuna Uygun. / Compatible with SMTM Insert.

Sipariş Örneği/Ordering Example : 1 ad./pcs. AHFM-WN09T3-D040-A16-Z04-H  
Kesme Hesabı : S 271 / Cutting Calculation : P 271  
Montaj Ölçüleri : S 269 / Mounting Reference : P 269

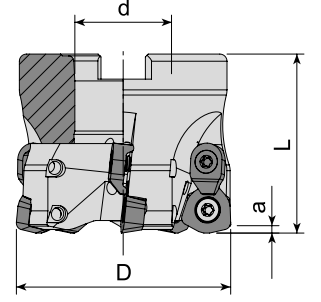

Takım Kodu Ordering Code	Stok Stock	Takım Ölçüleri (mm) Dimension (mm)					Kesici Uç Insert	Yedek Parçaları Spare Parts									
		D	Z	d	L	a		Sıkma Vidası Screw	Baskı Parçası Wedge Clamp	Baskı Vidası Clamp Screw	Tork Anahtar Torx Key	Montaj Vidası Mounting Screw					
AHFMC-WD06T3D-D042-A16-Z04-H	●	42	4	16	45	1.5	WD.W 06T3..						2506-M8x30				
AHFMC-WD06T3D-D050-A22-Z05-H	●	50	5	22	50	1.5							3015-M3.5x9	ACK-15	4015-M3.5x11	80-T15	2508-M10x30
AHFMC-WD06T3D-D052-A22-Z05-H	●	52	5	22	50	1.5											
AHFMC-WD0805D-D052-A22-Z04-H	●	52	4	22	50	2	WD.W 0805..										
AHFMC-WD0805D-D063-A27-Z05-H	●	63	5	27	50	2							4020-M4.5x12	ACK-19	4020-M4.5x12	80-T20	2510-M12x35
AHFMC-WD0805D-D066-A27-Z05-H	●	66	5	27	50	2											
AHFMC-WD0805D-D080-A27-Z05	●	80	5	27	50	2											
AHFMC-WD0805D-D100-A32-Z06	●	100	6	32	50	2	WD.W 10X6..						2514-M16x35				
AHFMC-WD10X6D-D125-B40-Z06	●	125	6	40	63	2.5											
AHFMC-WD10X6D-D160-C40-Z07	●	160	7	40	63	2.5											

R: Sağ/Right L: Sol/Left ● Stokta/In Stock ○ Stokta Yok/Non Stock Item  
DJT Ucuna Uygundur. / Compatible with DJT Insert.

Sipariş Örneği/Ordering Example : 1 ad./pcs. AHFMC-WD06T3D-D042-A16-Z04-H  
Kesme Hesabı : S 271 / Cutting Calculation : P 271  
Montaj Ölçüleri : S 269 / Mounting Reference : P 269



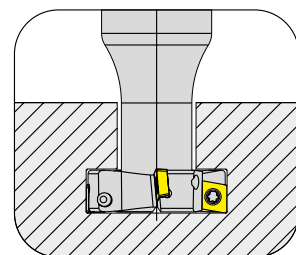
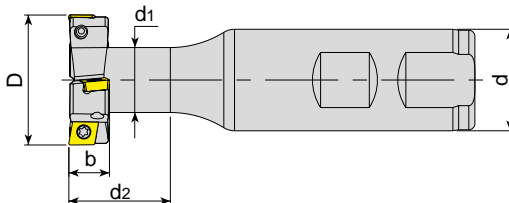

**Takım Kodu**  
Ordering Code

Takım Kodu Ordering Code	Stok Stock	Takım Ölçüleri (mm) Dimension (mm)							Kesici Uç Insert	Yedek Parçaları Spare Parts		
		Z		D	b	d	L	d <sub>1</sub>		d <sub>2</sub>	Sıkma Vidası Screw	Tork Anahtar Torx Key
		Toplam Total	Etkili Effective									
ATSM90-CC06-D17X8-W16-L85-Z02	●	2	1	17	8	16	85	10	CC.. 0602..	3008-M2.5x6	80-T08	
ATSM90-CC06-D32X8-W25-L100-Z04	●	4	2	32	8	25	100	16				
ATSM90-CC06-D28X8-W20-L66-Z04	●	4	2	28	8	20	66	14				
ATSM90-CC06-D45.5X8-W25-L100-Z06	●	6	3	45.5	8	25	100	12				
ATSM90-CC06-D63X8-W32-L125-Z08	●	8	4	63	8	32	125	31.5				
ATSM90-CC06-D18X9-W16-L90-Z02	●	2	1	18	9	16	90	10				
ATSM90-CC06-D20X9-W16-L85-Z04	●	4	2	20	9	16	85	10				
ATSM90-CC06-D23X10-W20-L90-Z04	●	4	2	23	10	20	90	12				
ATSM90-CC06-D32X10-W25-L100-Z04	●	4	2	32	10	25	100	16				
ATSM90-CC06-D45X10-W32-L120-Z06	●	6	3	45	10	32	120	20				
ATSM90-CC06-D25X11-W25-L100-Z04	●	4	2	25	11	25	100	13	CC.. 09T3..	4015-M3.5x9	80-T15	
ATSM90-CC09-D30X12-W25-L100-Z04	●	4	2	30	12	25	100	16				
ATSM90-CC09-D32X12-W25-L100-Z02	●	2	1	32	12	25	100	16				
ATSM90-CC09-D32X12-W25-L100-Z04	●	4	2	32	12	25	100	16				
ATSM90-CC09-D32X14-W25-L100-Z04	●	4	2	32	14	25	100	16				
ATSM90-CC09-D37X16-W32-L120-Z04	●	4	2	37	16	32	120	17				
ATSM90-CC09-D42X17-W32-L120-Z04	●	4	2	42	17	32	120	19				
ATSM90-CC09-D40X17-W32-L120-Z04-H	●	4	2	40	17	32	120	19	CC.. 1204..	1020-M5x11	80-T20	
ATSM90-CC12-D47X20-W32-L120-Z04	●	4	2	47	20	32	120	25				
ATSM90-CC12-D52X21-W32-L120-Z04	●	4	2	52	21	32	120	25				
ATSM90-CC12-D50X22-W32-L120-Z04	●	4	2	50	22	32	120	25				
ATSM90-CC12-D55X22-W32-L120-Z04	●	4	2	55	22	32	120	25				

R: Sağ/Right L: Sol/Left ● Stokta/In Stock ○ Stokta Yok/Non Stock Item

Sipariş Örneği/Ordering Example : 1 ad./pcs. ATSM90-CC06-D17X8-W16-L85-Z02  
Kesme Hesabı : S 271 / Cutting Calculation : P 271



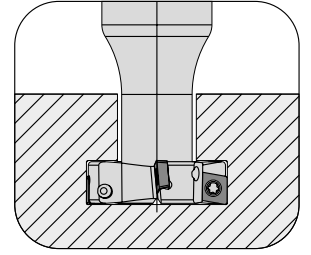
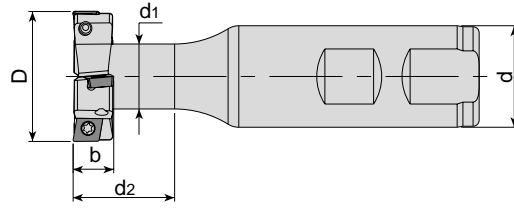

Takım Kodu Ordering Code	Stok Stock	Takım Ölçüleri (mm) Dimension (mm)								Yedek Parçaları Spare Parts		
		Z		D	b	d	L	d <sub>1</sub>	d <sub>2</sub>	Kesici Uç Insert	Sıkma Vidası Screw	Tork Anahtar Torx Key
		Toplam Total	Etkili Effective									
ATSM90-SP..05-D22.5X5-W25-L100-Z04	●	4	2	22.5	5	25	100	12	25	SPMG 050204 TGTC UCUNA UYGUNDUR. FOR TGTC INSERT.	3006-M2x4	80-T06
ATSM90-SP..05-D30X5-W25-L100-Z04	●	4	2	30	5	25	100	10	25			
ATSM90-SPGT0502-D63X6-W32-L125-Z10	●	10	5	63	6	32	125	31	30	SPGT 050204		
ATSM90-SPGT0904-D32X14-W32-L120-Z04-H	●	4	2	32	14	32	120	17.5	30	SPGT 090408 ZCC UCUNA UYGUNDUR. FOR ZCC INSERT.	4015-M3.5x9	80-T15
ATSM90-SPGT0904-D37X16-W32-L120-Z04-H	●	4	2	37	16	32	120	21	40			
ATSM90-SPGT0904-D42X17-W32-L120-Z04-H	●	4	2	42	17	32	120	21	40			
ATSM90-SPGT1104-D47X20-W32-L120-Z04-H	●	4	2	47	20	32	120	24	45	SPGT 110408	4015-M4x11	
ATSM90-SP..06-D80X7-W32-L120-Z10	●	10	5	80	7	32	120	32	30	SPMG 060204 TGTC UCUNA UYGUNDUR. FOR TGTC INSERT.	3007-M2.2x5	80-T07

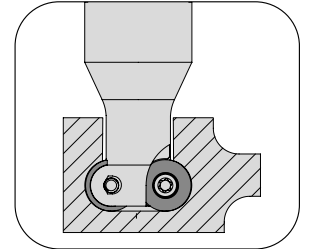
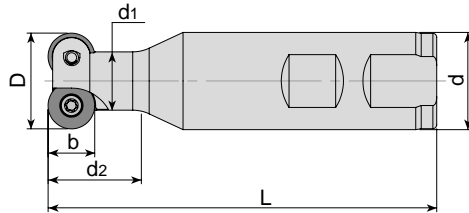

Takım Kodu Ordering Code	Stok Stock	Takım Ölçüleri (mm) Dimension (mm)								Yedek Parçaları Spare Parts		
		Z	D	b	d	L	d <sub>1</sub>	d <sub>2</sub>	Kesici Uç Insert	Sıkma Vidası Screw	Tork Anahtar Torx Key	
ATSMR-RD0702-D17-W16-L90-Z02	●	2	17	7	16	90	10	12	RD.. 0702	3008-M2.5x6	80-T08	
ATSMR-RD0702-D25-W16-L90-Z03	●	3	25	7	16	90	15	12				
ATSMR-RD0702-D35-W25-L100-Z05	●	5	35	7	25	100	20	20				
ATSMR-RD1003-D21-W25-L100-Z02	●	2	21	10	25	100	12	20	RD.. 1003	4015-M3.5x9	80-T15	
ATSMR-RD1003-D80-W32-L165-Z06-H	●	6	80	10	32	165	30	31.5				
ATSMR-RD12T3-D25-W25-L100-Z02	●	2	25	12	25	100	15	24	RD.. 12T3			
ATSMR-RD12T3-D80-W32-L165-Z06-H	●	6	80	12	32	165	30	31.5				
ATSMR-RD1604-D34-W32-L110-Z02	●	2	34	16	32	110	20	30	RD.. 1604	1515-M4.5x11		

R: Sağ/Right L: Sol/Left ● Stokta/In Stock ○ Stokta Yok/Non Stock Item

Sipariş Örneği/Ordering Example : 1 ad./pcs. ATSM90-SP..05-D22.5X5-W25-L100-Z04

Kesme Hesabı : S 271 / Cutting Calculation : P 271



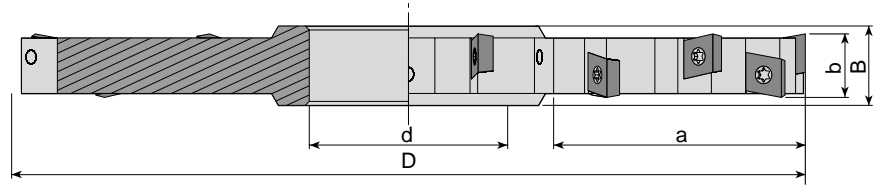

Takım Kodu Ordering Code	Stok Stock	Takım Ölçüleri (mm) Dimension (mm)							Yedek Parçaları Spare Parts		
		Z		D	b	a	d	B	Kesici Uç Insert	Sıkma Vidası Screw	Tork Anahtar Torx Key
		Toplam Total	Etkili Effective								
ASDM-SPGT05-D80x6-d27-Z10	●	10	5	80	6	17	27	10	SPGT 050204 ZCC UCUNA UYGUNDUR. FOR ZCC INSERT.	3006-M2x4	80-T06
ASDM-SPGT05-D100x6-d32-Z12	●	12	6	100	6	25	32	10			
ASDM-SPGT05-D125x6-d40-Z14	●	14	7	125	6	35	40	10			
ASDM-SPGT05-D160x6-d40-Z18	●	18	9	160	6	52	40	10			
ASDM-SPGT06-D80x7-d27-Z10	●	10	5	80	7	17	27	11	SPGT 060204 ZCC UCUNA UYGUNDUR. FOR ZCC INSERT.	3007-M2.2x5	80-T07
ASDM-SPGT06-D100x7-d32-Z12	●	12	6	100	7	25	32	11			
ASDM-SPGT06-D125x7-d40-Z14	●	14	7	125	7	35	40	11			
ASDM-SPGT06-D160x7-d40-Z16	●	16	8	160	7	52	40	11			
ASDM-SPGT06-D200x7-d40-Z18	●	18	9	200	7	70	40	11			

R: Sağ/Right L: Sol/Left ● Stokta/In Stock ○ Stokta Yok/Non Stock Item

Sipariş Örneği/Ordering Example : 1 ad./pcs. ASDM-SPGT05-D80x6-d27-Z10  
Kesme Hesabı : S 271 / Cutting Calculation : P 271



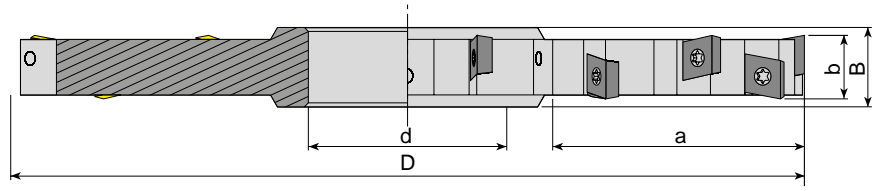

**Takım Kodu**  
Ordering Code

Takım Kodu Ordering Code	Stok Stock	Takım Ölçüleri (mm) Dimension (mm)							Yedek Parçaları Spare Parts		
		Z		D	b	a	d	B	Kesici Uç Insert	Sıkma Vidası Screw	Tork Anahtar Torx Key
		Toplam Total	Etkili Effective								
ASDM-CC06-D80x8-d27-Z10	●	10	5	80	8	17	27	12	CC.. 0602.. ISO UCUNA UYGUNDUR. FOR ISO INSERT.	3008-M2.5x6	80-T08
ASDM-CC06-D100x8-d32-Z12	●	12	6	100	8	25	32	12			
ASDM-CC06-D125x8-d40-Z14	●	14	7	125	8	35	40	12			
ASDM-CC06-D160x8-d40-Z16	●	16	8	160	8	52	40	12			
ASDM-CC06-D200x8-d40-Z18	●	18	9	200	8	70	40	12			
ASDM-CC06-D80x10-d27-Z10	●	10	5	80	10	17	27	14			
ASDM-CC06-D100x10-d32-Z12	●	12	6	100	10	25	32	14			
ASDM-CC06-D125x10-d40-Z14	●	14	7	125	10	35	40	14			
ASDM-CC06-D160x10-d40-Z16	●	16	8	160	10	52	40	14			
ASDM-CC06-D200x10-d40-Z18	●	18	9	200	10	70	40	14			
ASDM-CC09-D80x12-d27-Z08	●	8	4	80	12	17	27	16	CC.. 09T3.. ISO UCUNA UYGUNDUR. FOR ISO INSERT.	4015-M3.5x11	80-T15
ASDM-CC09-D100x12-d32-Z10	●	10	5	100	12	25	32	16			
ASDM-CC09-D125x12-d40-Z12	●	12	6	125	12	35	40	16			
ASDM-CC09-D160x12-d40-Z14	●	14	7	160	12	52	40	16			
ASDM-CC09-D200x12-d40-Z16	●	16	8	200	12	70	40	16			
ASDM-CC09-D80x14-d27-Z08	●	8	4	80	14	17	27	18			
ASDM-CC09-D100x14-d32-Z10	●	10	5	100	14	25	32	18			
ASDM-CC09-D125x14-d40-Z12	●	12	6	125	14	35	40	18			
ASDM-CC09-D160x14-d40-Z14	●	14	7	160	14	52	40	18			
ASDM-CC09-D200x14-d40-Z16	●	16	8	200	14	70	40	18			
ASDM-CC12-D80x16-d27-Z06	●	6	3	80	16	17	27	20	CC.. 1204.. ISO UCUNA UYGUNDUR. FOR ISO INSERT.	1020-M5x11	80-T20
ASDM-CC12-D100x16-d32-Z08	●	8	4	100	16	25	32	20			
ASDM-CC12-D125x16-d40-Z10	●	10	5	125	16	35	40	20			
ASDM-CC12-D160x16-d40-Z12	●	12	6	160	16	52	40	20			
ASDM-CC12-D200x16-d40-Z14	●	14	7	200	16	70	40	20			
ASDM-CC12-D80x18-d27-Z06	●	6	3	80	18	17	27	22			
ASDM-CC12-D100x18-d32-Z08	●	8	4	100	18	25	32	22			
ASDM-CC12-D125x18-d40-Z10	●	10	5	125	18	35	40	22			
ASDM-CC12-D160x18-d40-Z12	●	12	6	160	18	52	40	22			
ASDM-CC12-D200x18-d40-Z14	●	14	7	200	18	70	40	22			
ASDM-CC12-D250x18-d40-Z16	●	16	8	250	18	90	40	22			
ASDM-CC12-D80x20-d27-Z06	●	6	3	80	20	17	27	24			
ASDM-CC12-D100x20-d32-Z08	●	8	4	100	20	25	32	24			
ASDM-CC12-D125x20-d40-Z10	●	10	5	125	20	35	40	24			
ASDM-CC12-D160x20-d40-Z12	●	12	6	160	20	52	40	24			
ASDM-CC12-D200x20-d40-Z14	●	14	7	200	20	70	40	24			
ASDM-CC12-D250x20-d40-Z16	●	16	8	250	20	90	40	24			

R: Sağ/Right L: Sol/Left ● Stokta/In Stock ○ Stokta Yok/Non Stock Item

Sipariş Örneği/Ordering Example : 1 ad./pcs. ASDM-CC06-D80x8-d27-Z10  
Kesme Hesabı : S 271 / Cutting Calculation : P 271