

DIŞ TORNA TAKIMLARI
EXTERNAL TURNING TOOLHOLDERS





P **S** **K** **N** **R**

1 2 3 4 5

1 Sıkma Tipi / Method of Mounting of Insert

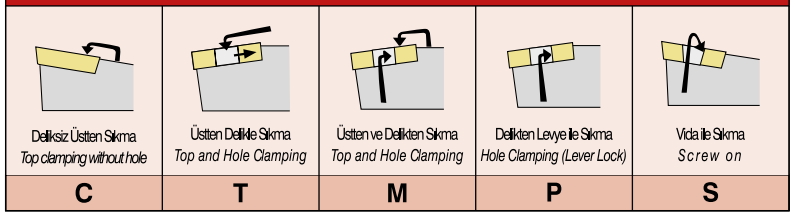

2 Uç Tipi / Insert Shape

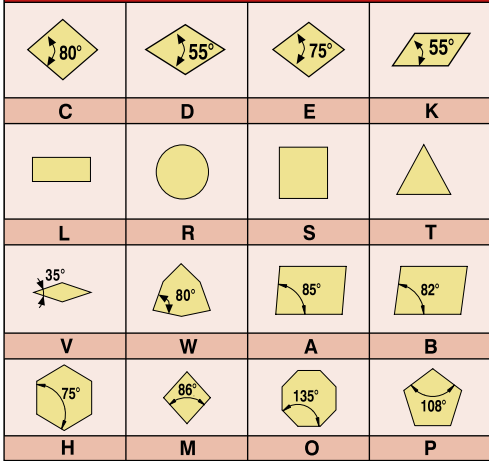

3 Yanaşma Açısı / ToolHolder Shape

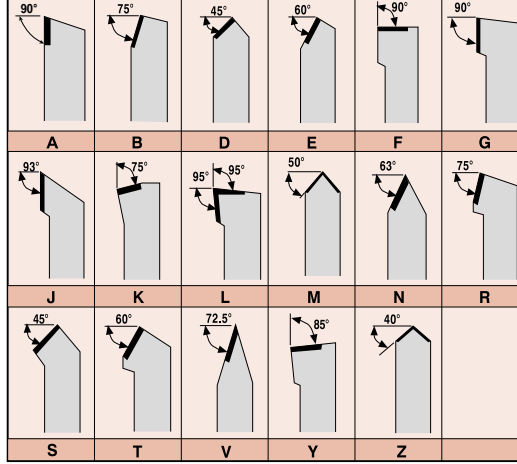

4 Serbest Uç Açısı
Clearance angle of Insert

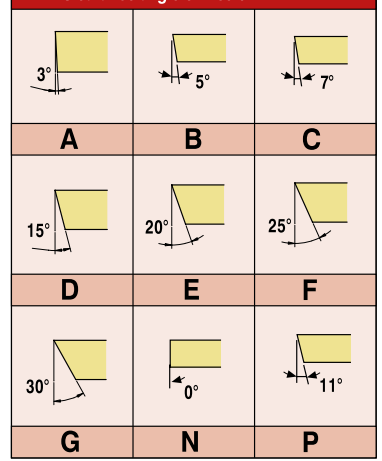

25 **25** - **M** **12** **C**

6 7 8 9 10

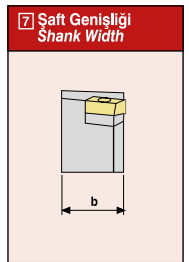
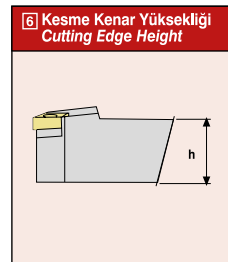
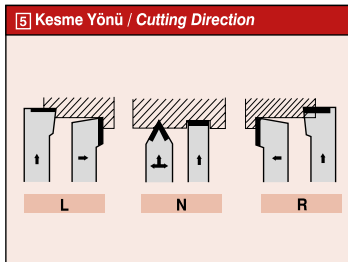

8 Şaft Boyu / Shank Length

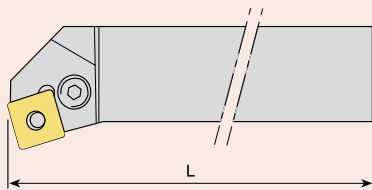

A - 32	H - 100	Q - 180	x-special
B - 40	J - 110	R - 200	
C - 50	K - 125	S - 250	
D - 60	L - 140	T - 300	
E - 70	M - 150	U - 350	
F - 80	N - 160	V - 400	
G - 90	P - 170	W - 450	

9 Kesme Kenar Uzunluğu / Cutting Edge Length

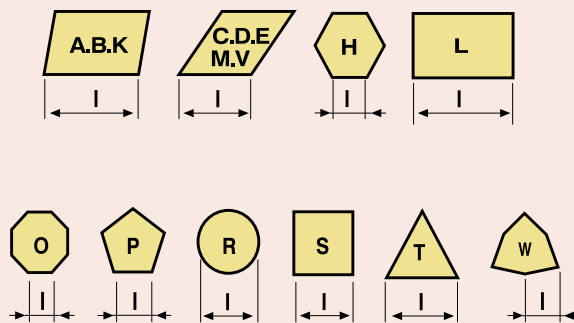

10 Baskı Pabucu/
Wedge Clamp

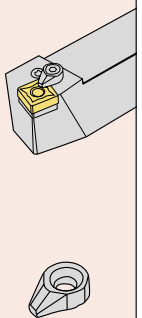



*konusulan
the spoken kalite...
quality...*

T-SİSTEM

T-SİSTEM DIŞ TORNA KATERLERİ

T-SYSTEM EXTERNAL TURNING TOOLHOLDERS



www.akkо.com.tr

Дистрибьютер ООО "Ресурс Плюс"
+7 (351) 247-74-40; info@rp-ural.ru

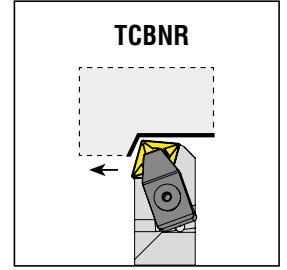
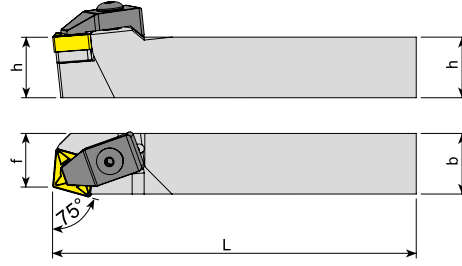

Takım Kodu Ordering Code	Stok Stock		Takım Ölçüleri (mm) Dimension (mm)				Kesici Uç Insert	Yedek Parçaları Spare Parts						
	R	L	h	b	L	f		Baskı Pabuçu Wedge Clamp	Pabuç Vidası Clamp Screw	Altık Shim	Altık Vidası Shim Screw	Yay Spring	Pul Stamp	Anahtar Allen Key
TCBNR/L 2525 M16	●	●	25	25	150	22						-		

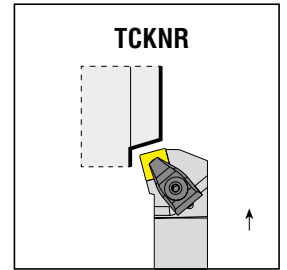
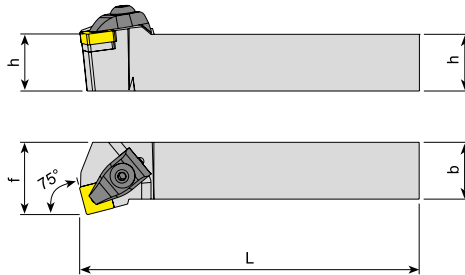

Takım Kodu Ordering Code	Stok Stock		Takım Ölçüleri (mm) Dimension (mm)				Kesici Uç Insert	Yedek Parçaları Spare Parts						
	R	L	h	b	L	f		Baskı Pabuçu Wedge Clamp	Pabuç Vidası Clamp Screw	Altık Shim	Altık Vidası Shim Screw	Yay Spring	Pul Stamp	Anahtar Allen Key
TCKNR/L 2020 K12	●	●	20	20	125	25								
2525 M12	●	●	25	25	150	32								
3232 P12	●	●	32	32	170	40								
2525 M16	●	●	25	25	150	32						-		
3232 P16	●	●	32	32	170	40								

R: Sağ/Right L: Sol/Left ● Stokta/In Stock ○ Stokta Yok/Non Stock Item

Sipariş Örneği/Ordering Example : 1 ad./pcs. TCBNR 2525 M16

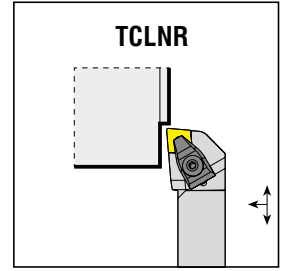
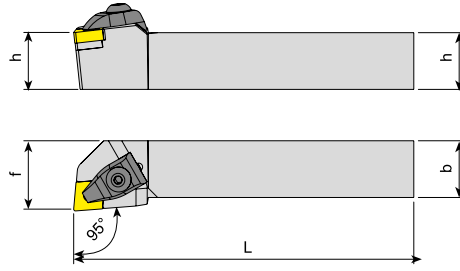

Takım Kodu Ordering Code	Stok Stock		Takım Ölçüleri (mm) Dimension (mm)				Kesici Uç Insert	Yedek Parçaları Spare Parts						
	R	L	h	b	L	f		Baskı Pabucu Wedge Clamp	Pabuç Vidası Clamp Screw	Altlık Shim	Altlık Vidası Shim Screw	Yay Spring	Pul Stamp	Anahtar Allen Key
TCLNR/L 2020 K12	●	●	20	20	125	25	CNM. 1204..							
2525 M12	●	●	25	25	150	32								
3232 P12	●	●	32	32	170	40								
4040 S12	●	●	40	40	250	50								
5050 S12	●	●	50	50	250	63	CNM. 1606..							
2525 M16	●	●	25	25	150	32								
3232 P16	●	●	32	32	170	40								

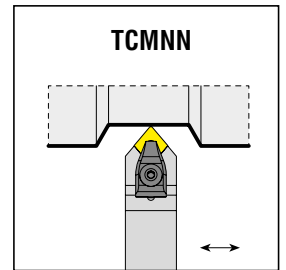
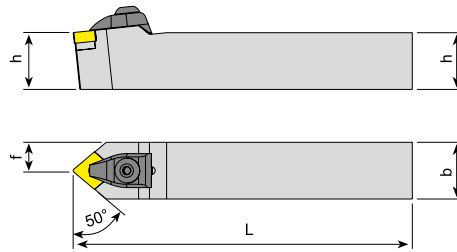

Takım Kodu Ordering Code	Stok Stock		Takım Ölçüleri (mm) Dimension (mm)				Kesici Uç Insert	Yedek Parçaları Spare Parts						
			h	b	L	f		Baskı Pabucu Wedge Clamp	Pabuç Vidası Clamp Screw	Altlık Shim	Altlık Vidası Shim Screw	Yay Spring	Pul Stamp	Anahtar Allen Key
TCMNN 1616 H12	●		16	16	100	8	CNM. 1204..							
2020 K12	●		20	20	125	10								
2525 M12	●		25	25	150	12.5								
3232 P12	●		32	32	170	16								
2525 M16	●		25	25	150	12.5	CNM. 1606..							
3232 P16	●		32	32	170	16								
4040 S16	○		40	40	250	20								

R: Sağ/Right L: Sol/Left ● Stokta/In Stock ○ Stokta Yok/Non Stock Item

Sipariş Örneği/Ordering Example : 1 ad./pcs. TCLNR 2020 K12

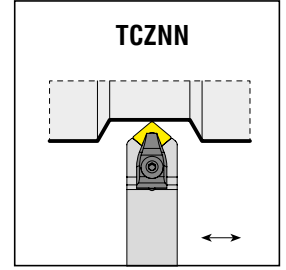
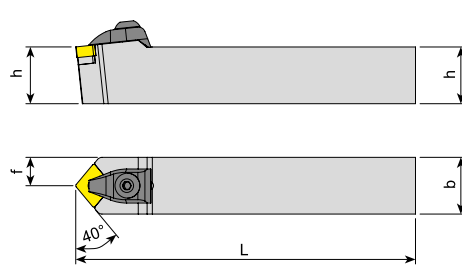

Takım Kodu Ordering Code	Stok Stock		Takım Ölçüleri (mm) Dimension (mm)				Kesici Uç Insert	Yedek Parçaları Spare Parts						
	R	L	h	b	L	f		Baskı Pabucu Wedge Clamp	Pabuç Vidası Clamp Screw	Altlık Shim	Altlık Vidası Shim Screw	Yay Spring	Pul Stamp	Anahtar Allen Key
TCZNN 2020 K12	●		20	20	125	10	CNM. 1204..							
2525 M12	●		25	25	150	12.5								
3232 P12	●		32	32	170	16								
2525 M16	●		25	25	150	12.5	CNM. 1606..							
3232 P16	●		32	32	170	16								

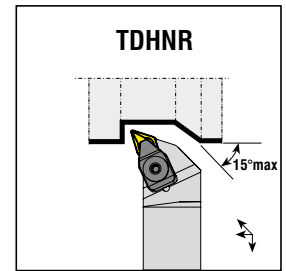
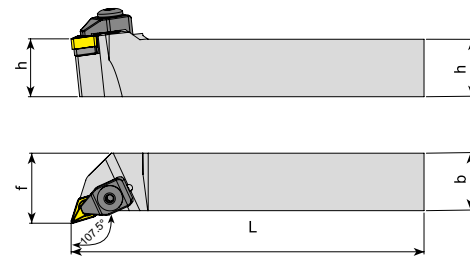

Takım Kodu Ordering Code	Stok Stock		Takım Ölçüleri (mm) Dimension (mm)				Kesici Uç Insert	Yedek Parçaları Spare Parts						
	R	L	h	b	L	f		Baskı Pabucu Wedge Clamp	Pabuç Vidası Clamp Screw	Altlık Shim	Altlık Vidası Shim Screw	Yay Spring	Pul Stamp	Anahtar Allen Key
TDHNR/L 2020 K15	●	●	20	20	125	25	DNM. 1506..							
2525 M15	●	●	25	25	150	32								
3232 P15	●	●	32	32	170	40								

R: Sağ/Right L: Sol/Left ● Stokta/In Stock ○ Stokta Yok/Non Stock Item

Sipariş Örneği/Ordering Example : 1 ad./pcs. TCZNN 2020 K12

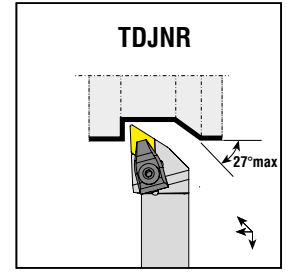
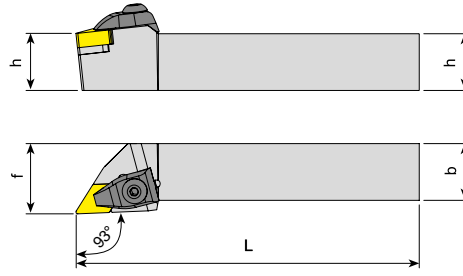

Takım Kodu Ordering Code	Stok Stock		Takım Ölçüleri (mm) Dimension (mm)				Kesici Uç Insert	Yedek Parçaları Spare Parts						
	R	L	h	b	L	f		Baskı Pabucu Wedge Clamp	Pabuç Vidası Clamp Screw	Altılık Shim	Altılık Vidası Shim Screw	Yay Spring	Pul Stamp	Anahtar Allen Key
TDJNR/L 1616 H11	●	●	16	16	100	20	DNM. 1104..							
2020 K11	●	●	20	20	125	25								
2525 M11	●	●	25	25	150	32								
2020 K15	●	●	20	20	125	25	DNM. 1506..							
2525 M15	●	●	25	25	150	32								
3232 P15	●	●	32	32	170	40								
4040 S15	●	●	40	40	250	50								
5050 S15	○	○	50	50	250	63	DNM. 1504..							
2020 K1504	●	●	20	20	125	25								
2525 M1504	●	●	25	25	150	32								
3232 P1504	●	●	32	32	170	40								
4040 S1504	●	●	40	40	250	50								

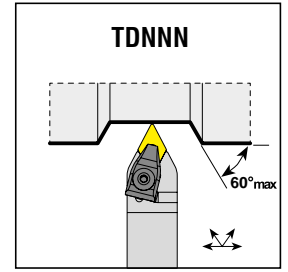
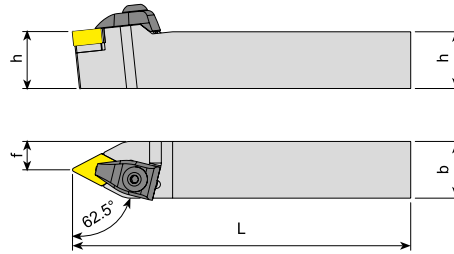

Takım Kodu Ordering Code	Stok Stock		Takım Ölçüleri (mm) Dimension (mm)				Kesici Uç Insert	Yedek Parçaları Spare Parts						
	R	L	h	b	L	f		Baskı Pabucu Wedge Clamp	Pabuç Vidası Clamp Screw	Altılık Shim	Altılık Vidası Shim Screw	Yay Spring	Pul Stamp	Anahtar Allen Key
TDNNN 1616 H11	●	●	16	16	100	8	DNM. 1104..							
2020 K11	●	●	20	20	125	10								
2525 M11	●	●	25	25	150	12.5								
2020 K15	●	●	20	20	125	10	DNM. 1506..							
2525 M15	●	●	25	25	150	12.5								
3232 P15	●	●	32	32	170	16								
4040 S15	○	○	40	40	250	20								
5050 S15	○	○	50	50	250	25								

R: Sağ/Right L: Sol/Left ● Stokta/In Stock ○ Stokta Yok/Non Stock Item

Sipariş Örneği/Ordering Example : 1 ad./pcs. TDJNR 1616 H11

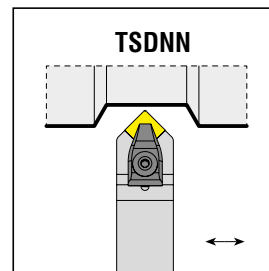
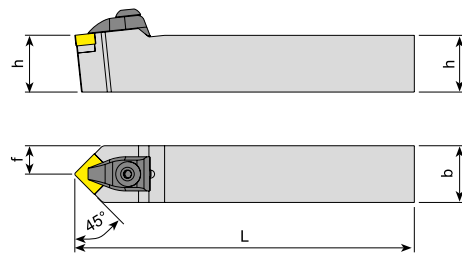

Takım Kodu Ordering Code	Stok Stock	Takım Ölçüleri (mm) Dimension (mm)				Kesici Uç Insert	Yedek Parçaları Spare Parts						
							Baskı Pabucu Wedge Clamp	Pabuç Vidası Clamp Screw	Altılık Shim	Altılık Vidası Shim Screw	Yay Spring	Pul Stamp	Anahtar Allen Key
		h	b	L	f								
TSDNN 1616 H12	●	16	16	100	8	SNM. 1204..							
2020 K12	●	20	20	125	10								
2525 M12	●	25	25	150	12.5								
3232 P12	●	32	32	170	16								
2525 M15	○	25	25	150	12.5	SNM. 1506..					-		
3232 P15	○	32	32	170	16								
4040 S15	○	40	40	250	20								

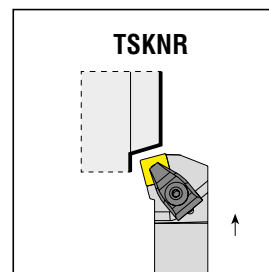
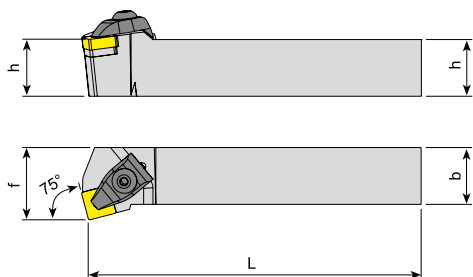

Takım Kodu Ordering Code	Stok Stock	Takım Ölçüleri (mm) Dimension (mm)				Kesici Uç Insert	Yedek Parçaları Spare Parts						
							Baskı Pabucu Wedge Clamp	Pabuç Vidası Clamp Screw	Altılık Shim	Altılık Vidası Shim Screw	Yay Spring	Pul Stamp	Anahtar Allen Key
		R	L	h	b		L	f					
TSKNR/L 2020 K12	● ●	20	20	125	25	SNM. 1204..							
2525 M12	● ●	25	25	150	32								
3232 P12	● ●	32	32	170	40								
3232 P15	● ●	32	32	170	40								
						SNM. 1506..					-		

R: Sağ/Right L: Sol/Left ● Stokta/In Stock ○ Stokta Yok/Non Stock Item

Sipariş Örneği/Ordering Example : 1 ad./pcs. TSDNN 1616 H12

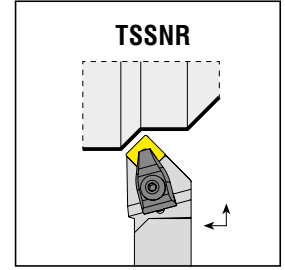
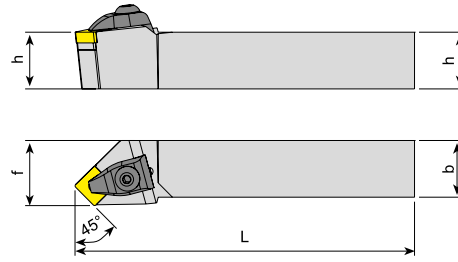

Takım Kodu Ordering Code	Stok Stock		Takım Ölçüleri (mm) Dimension (mm)				Kesici Uç Insert	Yedek Parçaları Spare Parts						
	R	L	h	b	L	f		Baskı Pabucu Wedge Clamp	Pabuç Vidası Clamp Screw	Altlık Shim	Altlık Vidası Shim Screw	Yay Spring	Pul Stamp	Anahtar Allen Key
TSSNR/L 2020 K12	●	●	20	20	125	25								
2525 M12	●	●	25	25	150	32								
3232 P12	●	●	32	32	170	40								
2525 M15	●	●	25	25	150	32								
3232 P15	●	●	32	32	170	40								

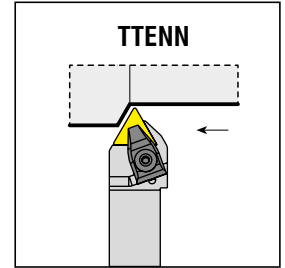
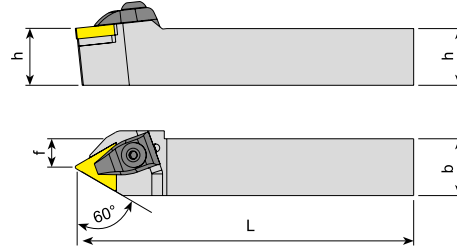

Takım Kodu Ordering Code	Stok Stock		Takım Ölçüleri (mm) Dimension (mm)				Kesici Uç Insert	Yedek Parçaları Spare Parts						
			h	b	L	f		Baskı Pabucu Wedge Clamp	Pabuç Vidası Clamp Screw	Altlık Shim	Altlık Vidası Shim Screw	Yay Spring	Pul Stamp	Anahtar Allen Key
TTENN 2020 K16	●		20	20	125	10								
2525 M16	●		25	25	150	12.5								
3232 P16	●		32	32	170	16								
2525 M22	●		25	25	150	12.5								
3232 P22	●		32	32	170	16								
4040 S22	○		40	40	250	20								

R: Sağ/Right L: Sol/Left ● Stokta/In Stock ○ Stokta Yok/Non Stock Item

Sipariş Örneği/Ordering Example : 1 ad./pcs. TSSNR 2020 K12

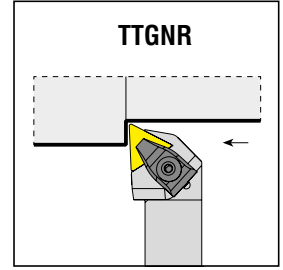
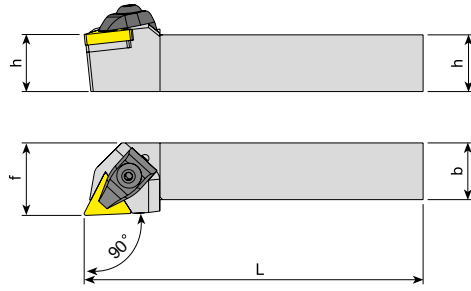

Takım Kodu Ordering Code	Stok Stock		Takım Ölçüleri (mm) Dimension (mm)				Kesici Uç Insert	Yedek Parçaları Spare Parts							
	R	L	h	b	L	f		Baskı Pabucu Wedge Clamp	Pabuç Vidası Clamp Screw	Altık Shim	Altık Vidası Shim Screw	Yay Spring	Pul Stamp	Anahtar Allen Key	
TTGNR/L 2020 K16	●	●	20	20	125	25									
2525 M16	●	●	25	25	150	32									-
3232 P16	●	●	32	32	170	40									
2525 M22	●	●	25	25	150	32									
3232 P22	●	●	32	32	170	40									
4040 S22	○	○	40	40	250	50									

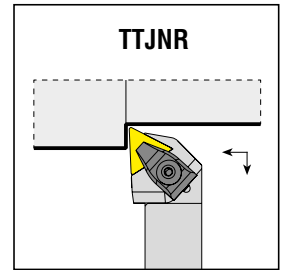
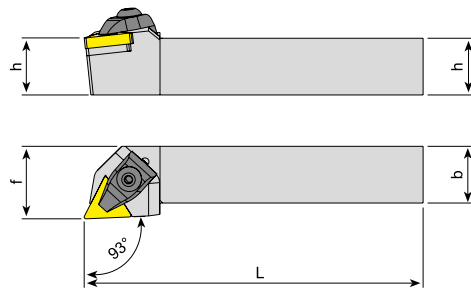
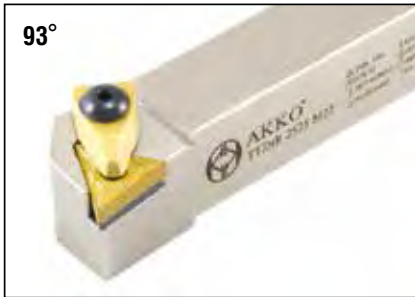

Takım Kodu Ordering Code	Stok Stock		Takım Ölçüleri (mm) Dimension (mm)				Kesici Uç Insert	Yedek Parçaları Spare Parts							
	R	L	h	b	L	f		Baskı Pabucu Wedge Clamp	Pabuç Vidası Clamp Screw	Altık Shim	Altık Vidası Shim Screw	Yay Spring	Pul Stamp	Anahtar Allen Key	
TTJNR/L 2020 K16	●	●	20	20	125	25									
2525 M16	●	●	25	25	150	32									-
3232 P16	●	●	32	32	170	40									
2525 M22	●	●	25	25	150	32									
3232 P22	●	●	32	32	170	40									
4040 S22	○	○	40	40	250	50									

R: Sağ/Right L: Sol/Left ●Stokta/In Stock ○Stokta Yok/Non Stock Item

Sipariş Örneği/Ordering Example : 1 ad./pcs. TTGNR 2020 K16

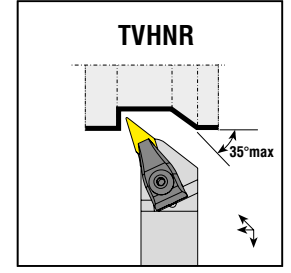
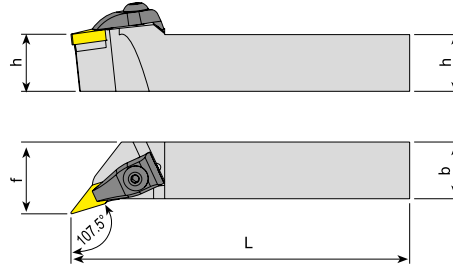

Takım Kodu Ordering Code	Stok Stock		Takım Ölçüleri (mm) Dimension (mm)				Kesici Uç Insert	Yedek Parçaları Spare Parts						
	R	L	h	b	L	f		Baskı Pabucu Wedge Clamp	Pabuç Vidası Clamp Screw	Altlık Shim	Altlık Vidası Shim Screw	Yay Spring	Pul Stamp	Anahtar Allen Key
TVHNR/L 2020 K16	●	●	20	20	125	25	VNM. 1604..	ATK-03	AKV-02-M6x22	AAVN-2-0002	AAV-04-M5x12	AKY-01	ABPL-01	AAL-03-3
2525 M16	●	●	25	25	150	32								
3232 P16	●	●	32	32	170	40								

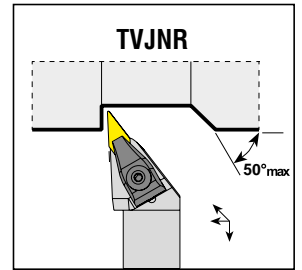
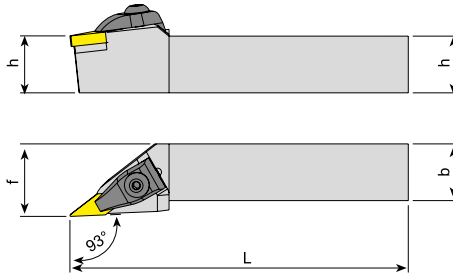

Takım Kodu Ordering Code	Stok Stock		Takım Ölçüleri (mm) Dimension (mm)				Kesici Uç Insert	Yedek Parçaları Spare Parts						
	R	L	h	b	L	f		Baskı Pabucu Wedge Clamp	Pabuç Vidası Clamp Screw	Altlık Shim	Altlık Vidası Shim Screw	Yay Spring	Pul Stamp	Anahtar Allen Key
TVJNR/L 2020 K16	●	●	20	20	125	25	VNM. 1604..	ATK-03	AKV-02-M6x22	AAVN-2-0002	AAV-04-M5x12	AKY-01	ABPL-01	AAL-03-3
2525 M16	●	●	25	25	150	32								
3232 P16	●	●	32	32	170	40								

R: Sağ/Right L: Sol/Left ● Stokta/In Stock ○ Stokta Yok/Non Stock Item

Sipariş Örneği/Ordering Example : 1 ad./pcs. TVHNR 2020 K16

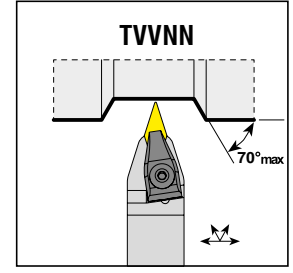
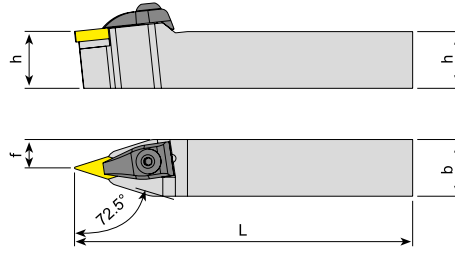

Takım Kodu Ordering Code	Stok Stock		Takım Ölçüleri (mm) Dimension (mm)				Kesici Uç Insert	Yedek Parçaları Spare Parts						
	R	L	h	b	L	f		Baskı Pabucu Wedge Clamp	Pabuç Vidası Clamp Screw	Altılık Shim	Altılık Vidası Shim Screw	Yay Spring	Pul Stamp	Anahtar Allen Key
TVVNN 2020 K16	●		20	20	125	10								
2525 M16	●		25	25	150	12.5								
3232 P16	●		32	32	170	16								

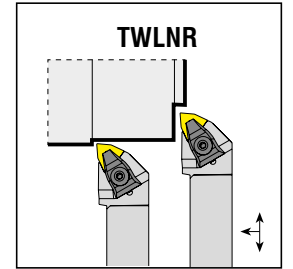
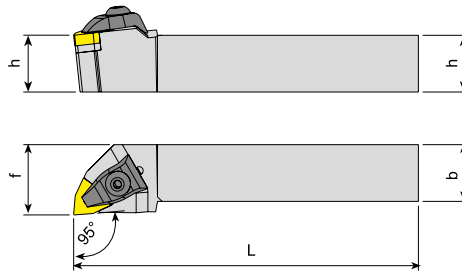

Takım Kodu Ordering Code	Stok Stock		Takım Ölçüleri (mm) Dimension (mm)				Kesici Uç Insert	Yedek Parçaları Spare Parts						
	R	L	h	b	L	f		Baskı Pabucu Wedge Clamp	Pabuç Vidası Clamp Screw	Altılık Shim	Altılık Vidası Shim Screw	Yay Spring	Pul Stamp	Anahtar Allen Key
TWLNR/L 1616 H06	●	●	16	16	100	20								
2020 K06	●	●	20	20	125	25								
2525 M06	●	●	25	25	150	32								
2020 K08	●	●	20	20	125	25								
2525 M08	●	●	25	25	150	32								
3232 P08	●	●	32	32	170	40								
4040 S08	○	○	40	40	250	50								
5050 S08	○	○	50	50	250	63								

R: Sağ/Right L: Sol/Left ● Stokta/In Stock ○ Stokta Yok/Non Stock Item

Sipariş Örneği/Ordering Example : 1 ad./pcs. TVVNN 2020 K16



*konusulan
the spoken kalite...
quality...*

M-SİSTEM

M-SİSTEM DIŞ TORNA KATERLERİ

M-SYSTEM EXTERNAL TURNING TOOLHOLDERS



www.akkо.com.tr

Дистрибьютер ООО "Ресурс Плюс"
+7 (351) 247-74-40; info@rp-ural.ru

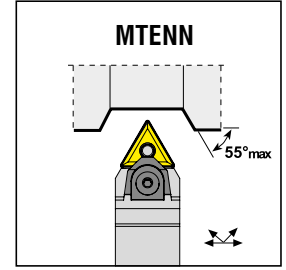
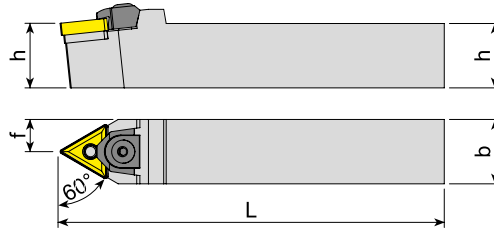

Takım Kodu Ordering Code	Stok Stock		Takım Ölçüleri (mm) Dimension (mm)				Kesici Uç Insert	Yedek Parçaları Spare Parts					
	R	L	h	b	L	f		Baskı Pabucu Wedge Clamp	Pabuç Vidası Clamp Screw	Altık Shim	Pim Pin	Pul Stamp	Anahtar Allen Key
MTENN 2020 K16	●		20	20	125	10	TNM. 1604..	AMK-04	AKV-02-M6x22	AATN-2-0002	APM-01	ABPL-01	AAL-03-3
2525 M16	●		25	25	150	12.5							
3232 P16	●		32	32	170	16	TNM. 2204..			AATN-3-0015	APM-02		
2525 M22	●		25	25	150	12.5							
3232 P22	●		32	32	170	16							
4040 S22	○		40	40	250	20							

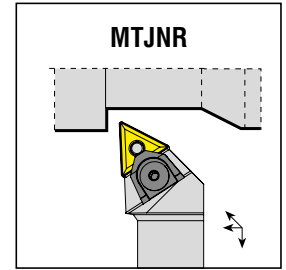
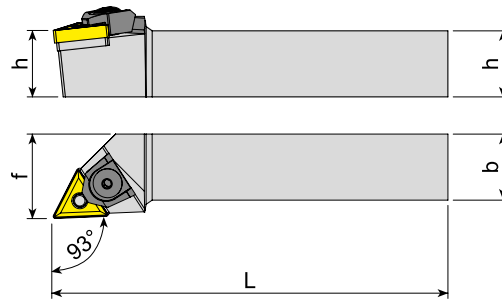

Takım Kodu Ordering Code	Stok Stock		Takım Ölçüleri (mm) Dimension (mm)				Kesici Uç Insert	Yedek Parçaları Spare Parts					
	R	L	h	b	L	f		Baskı Pabucu Wedge Clamp	Pabuç Vidası Clamp Screw	Altık Shim	Pim Pin	Pul Stamp	Anahtar Allen Key
MTJNR/L 2020 K16	●	●	20	20	125	25	TNM. 1604..	AMK-04	AKV-02-M6x22	AATN-2-0002	APM-01	ABPL-01	AAL-03-3
2525 M16	●	●	25	25	150	32							
3232 P16	●	●	32	32	170	40	TNM. 2204..			AATN-3-0015	APM-02		
2525 M22	●	●	25	25	150	32							
3232 P22	●	●	32	32	170	40							
4040 S22	●	●	40	40	250	50							

R: Sağ/Right L: Sol/Left ● Stokta/In Stock ○ Stokta Yok/Non Stock Item

Sipariş Örneği/Ordering Example : 1 ad./pcs. MTENN 2020 K16

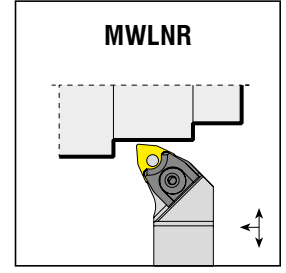
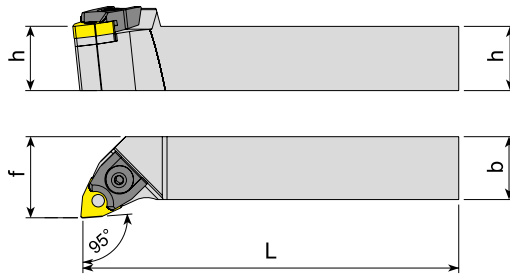

Takım Kodu Ordering Code	Stok Stock		Takım Ölçüleri (mm) Dimension (mm)				Kesici Uç Insert	Yedek Parçaları Spare Parts					
	R	L	h	b	L	f		Baskı Pabucu Wedge Clamp	Pabuç Vidası Clamp Screw	Altlık Shim	Pim Pin	Pul Stamp	Anahtar Allen Key
MWLNR/L 1616 H06	●	●	16	16	100	20				-	APM-08	-	AAL-03-3
2020 K06	●	●	20	20	125	25							
2525 M06	●	●	25	25	150	32							
2020 K08	●	●	20	20	125	25		AMK-05	AKV-03-M6x22	AAWN-3-0001	APM-02	ABPL-01	
2525 M08	●	●	25	25	150	32							
3232 P08	●	●	32	32	170	40							

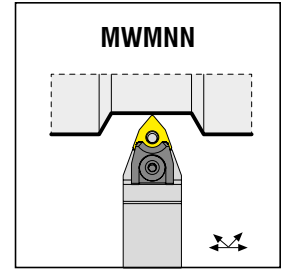
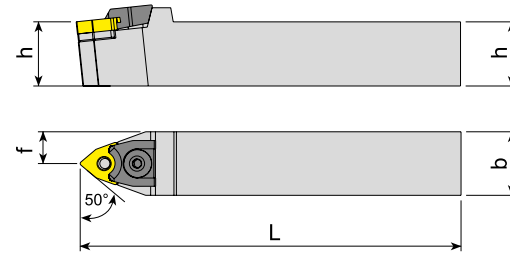

Takım Kodu Ordering Code	Stok Stock		Takım Ölçüleri (mm) Dimension (mm)				Kesici Uç Insert	Yedek Parçaları Spare Parts					
			h	b	L	f		Baskı Pabucu Wedge Clamp	Pabuç Vidası Clamp Screw	Altlık Shim	Pim Pin	Pul Stamp	Anahtar Allen Key
MWMNN 1616 H06	●		16	16	100	8				-	APM-08	-	AAL-03-3
2020 K06	●		20	20	125	10							
2525 M06	●		25	25	150	12.5							
2020 K08	●		20	20	125	10		AMK-05	AKV-03-M6x22	AAWN-3-0001	APM-02	ABPL-01	
2525 M08	●		25	25	150	12.5							
3232 P08	●		32	32	170	16							

R: Sağ/Right L: Sol/Left ● Stokta/In Stock ○ Stokta Yok/Non Stock Item

Sipariş Örneği/Ordering Example : 1 ad./pcs. MWLNR 1616 H06

P-SİSTEM

P-SİSTEM DIŞ TORNA KATERLERİ

P-SYSTEM EXTERNAL TURNING TOOLHOLDERS

*konusulan
the spoken kalite...
quality...*



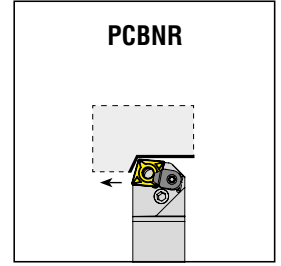
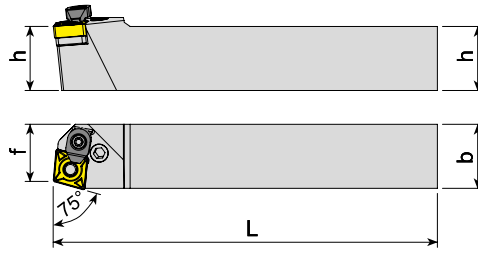

Takım Kodu Ordering Code	Stok Stock		Takım Ölçüleri (mm) Dimension (mm)				Kesici Uç Insert	Yedek Parçaları Spare Parts						
	R	L	h	b	L	f		Levyeye	Levyeye Vidası	Altılık	Altılık Yayı	Baskı Parçası	Baskı Vidası	Anahtar
								Lever	Lever Screw	Shim	Shim Spring	Wedge Clamp	Clamp Screw	Allen Key
PCBNR/L 2020 K12C	●	●	20	20	125	17.5								
2525 M12C	●	●	25	25	150	22.5	CNM. 1204..	APL-02	ALV-03-M8x19	AACN-3-0001	AAY-02	ACK-05	1515-M4x11	AAL-03-3
3232 P12C	●	●	32	32	170	29.5		APL-04	ALV-04-M8x22	AACN-3-0002	AAY-03	ACK-09	AAV-05-M6x15	AAL-05-4
2525 M16C	●	●	25	25	150	22		APL-05	ALV-05-M10x27	AACN-3-0003	AAY-04			
3232 P16C	●	●	32	32	170	27	CNM. 1906..	APL-06	ALV-06-M12x36	AACN-3-0008	AAY-05	ACK-04	AKV-16-M6x16	AAL-07-5
3232 P19C	●	●	32	32	170	27		APL-05	ALV-05-M10x27	AACN-3-0003	AAY-04			
4040 S19C	●	●	40	40	250	37	CNM. 2509..	APL-06	ALV-06-M12x36	AACN-3-0008	AAY-05	ACK-04	AKV-16-M6x16	AAL-07-5
4040 S25C	●	●	40	40	250	37		APL-06	ALV-06-M12x36	AACN-3-0008	AAY-05	ACK-04	AKV-16-M6x16	AAL-07-5
5050 S25C	○	○	50	50	250	47		APL-06	ALV-06-M12x36	AACN-3-0008	AAY-05	ACK-04	AKV-16-M6x16	AAL-07-5

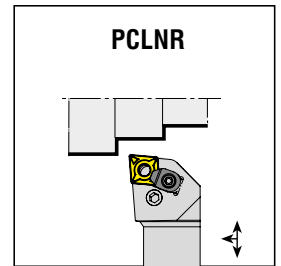
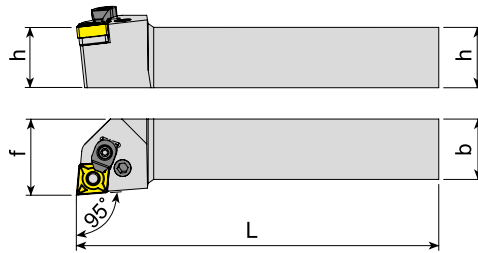

Takım Kodu Ordering Code	Stok Stock		Takım Ölçüleri (mm) Dimension (mm)				Kesici Uç Insert	Yedek Parçaları Spare Parts						
	R	L	h	b	L	f		Levyeye	Levyeye Vidası	Altılık	Altılık Yayı	Baskı Parçası	Baskı Vidası	Anahtar
								Lever	Lever Screw	Shim	Shim Spring	Wedge Clamp	Clamp Screw	Allen Key
PCLNR/L 1616 H09	●	●	16	16	100	20								
2020 K09	●	●	20	20	125	25	CNM. 0903..	APL-01	ALV-02-M6x17	AACN-2-0002	AAY-01	-	-	AAL-02-2.5
2525 M09	●	●	25	25	150	32		APL-02	ALV-03-M8x19	AACN-3-0001	AAY-02	ACK-05	1515-M4x11	AAL-03-3
1616 H12	●	●	16	16	100	20		APL-04	ALV-04-M8x22	AACN-3-0002	AAY-03	ACK-09	AAV-05-M6x15	AAL-05-4
2020 K12C	●	●	20	20	125	25	APL-05	ALV-05-M10x27	AACN-3-0003	AAY-04				
2525 M12C	●	●	25	25	150	32	CNM. 1606..	APL-06	ALV-06-M12x36	AACN-3-0008	AAY-05	ACK-04	AKV-16-M6x16	AAL-07-5
3232 P12C	●	●	32	32	170	40		APL-04	ALV-04-M8x22	AACN-3-0002	AAY-03			
2525 M16C	●	●	25	25	150	32	CNM. 1906..	APL-05	ALV-05-M10x27	AACN-3-0003	AAY-04			
3232 P16C	●	●	32	32	170	40		APL-06	ALV-06-M12x36	AACN-3-0008	AAY-05	ACK-04	AKV-16-M6x16	AAL-07-5
2525 M19C	●	●	25	25	150	32		APL-05	ALV-05-M10x27	AACN-3-0003	AAY-04			
3232 P19C	●	●	32	32	170	40	CNM. 2509..	APL-06	ALV-06-M12x36	AACN-3-0008	AAY-05	ACK-04	AKV-16-M6x16	AAL-07-5
4040 S19C	●	●	40	40	250	50		APL-06	ALV-06-M12x36	AACN-3-0008	AAY-05	ACK-04	AKV-16-M6x16	AAL-07-5
4040 S25C	●	●	40	40	250	50		APL-06	ALV-06-M12x36	AACN-3-0008	AAY-05	ACK-04	AKV-16-M6x16	AAL-07-5
5050 S25C	●	●	50	50	250	60	APL-06	ALV-06-M12x36	AACN-3-0008	AAY-05	ACK-04	AKV-16-M6x16	AAL-07-5	

R: Sağ/Right L: Sol/Left ● Stokta/In Stock ○ Stokta Yok/Non Stock Item

Sipariş Örneği/Ordering Example : 1 ad./pcs. PCBNR 2020 K12C

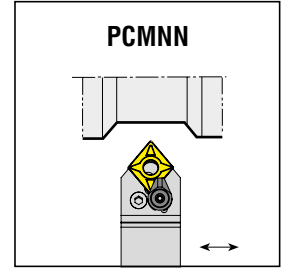
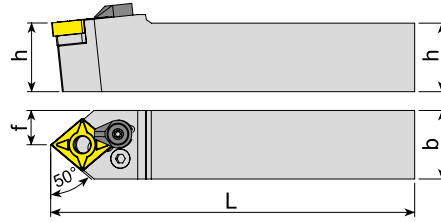

Takım Kodu Ordering Code	Stok Stock		Takım Ölçüleri (mm) Dimension (mm)				Kesici Uç Insert	Yedek Parçaları Spare Parts						
	R	L	h	b	L	f		Levye Lever	Levye Vidası Lever Screw	Aitlik Shim	Aitlik Yayı Shim Spring	Baskı Parçası Wedge Clamp	Baskı Vidası Clamp Screw	Anahtar Allen Key
PCMNN 2020 K12C	●		20	20	125	10								
2525 M12C	●		25	25	150	12.5								
3232 P12C	○		32	32	170	16								
2525 M16C	○		25	25	150	12.5								
3232 P16C	○		32	32	170	16								
3232 P19C	●		32	32	170	16								
4040 S19C	○		40	40	250	20								
5050 S19C	○		50	50	250	25								
4040 S25C	●		40	40	250	20								

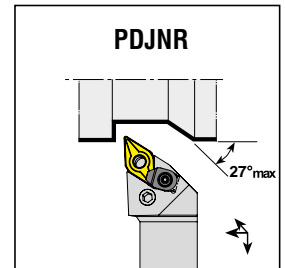
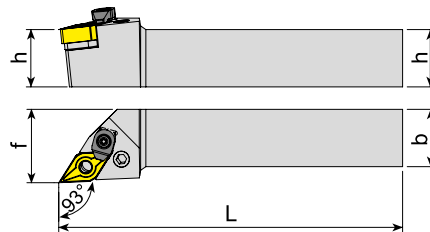

Takım Kodu Ordering Code	Stok Stock		Takım Ölçüleri (mm) Dimension (mm)				Kesici Uç Insert	Yedek Parçaları Spare Parts						
	R	L	h	b	L	f		Levye Lever	Levye Vidası Lever Screw	Aitlik Shim	Aitlik Yayı Shim Spring	Baskı Parçası Wedge Clamp	Baskı Vidası Clamp Screw	Anahtar Allen Key
PDJNR/L 1616 H11	●	●	16	16	100	20								
2020 K11	●	●	20	20	125	25								
2525 M11	●	●	25	25	150	32								
2020 K15C	●	●	20	20	125	25								
2525 M15C	●	●	25	25	150	32								
3232 P15C	●	●	32	32	170	40								
4040 S15C	●	●	40	40	250	50								

R: Sağ/Right L: Sol/Left ● Stokta/In Stock ○ Stokta Yok/Non Stock Item

Sipariş Örneği/Ordering Example : 1 ad./pcs. PCMNN 2020 K12C

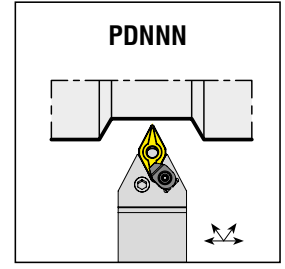
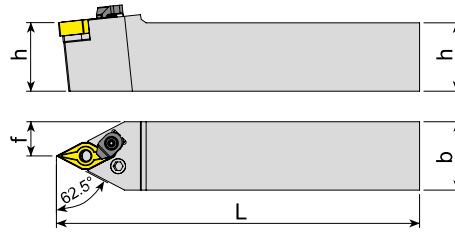

Takım Kodu Ordering Code	Stok Stock		Takım Ölçüleri (mm) Dimension (mm)				Kesici Uç Insert	Yedek Parçaları Spare Parts						
	R	L	h	b	L	f		Levye Lever	Levye Vidası Lever Screw	Altık Shim	Altık Yayı Shim Spring	Baskı Parçası Wedge Clamp	Baskı Vidası Clamp Screw	Anahtar Allen Key
PDN1616 H11	●		16	16	100	8	DNM. 1104..	APL-01	ALV-02-M6x17	AADN-SD317	AAY-01	-	-	AAL-02-2.5
2020 K11	●		20	20	125	10								
2525 M11	●		25	25	150	12.5								
2020 K15C	●		20	20	125	10	DNM. 1506..	APL-03	ALV-03-M8x19	AADN-3-0001	AAY-02	ACK-05	1515-M4x11	AAL-03-3
2525 M15C	●		25	25	150	12.5								
3232 P15C	●		32	32	170	16								

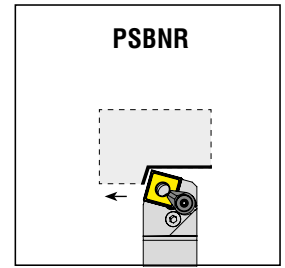
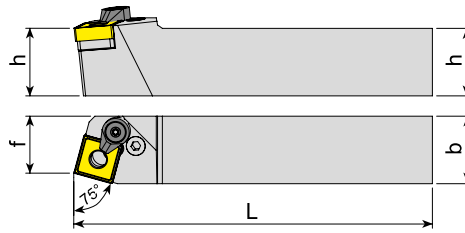
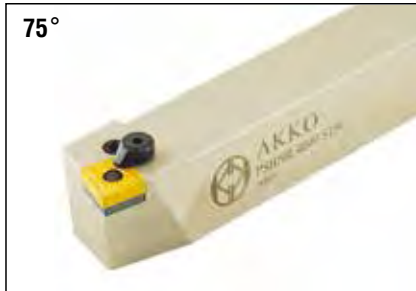

Takım Kodu Ordering Code	Stok Stock		Takım Ölçüleri (mm) Dimension (mm)				Kesici Uç Insert	Yedek Parçaları Spare Parts						
	R	L	h	b	L	f		Levye Lever	Levye Vidası Lever Screw	Altık Shim	Altık Yayı Shim Spring	Baskı Parçası Wedge Clamp	Baskı Vidası Clamp Screw	Anahtar Allen Key
PSB1616 H09	●	●	16	16	100	13	SNM. 0903..	APL-01	ALV-02-M6x17	AASN-2-0002	AAY-01	-	-	AAL-02-2.5
2020 K09	○	○	20	20	125	17								
2020 K12	●	●	20	20	125	17								
2525 M12C	●	●	25	25	150	22	SNM. 1204..	APL-02	ALV-03-M8x19	AASN-3-0004	AAY-02	ACK-05	1515-M4x11	AAL-03-3
3232 P12C	●	●	32	32	170	27								
2525 M15	○	●	25	25	150	22								
3232 P15C	●	●	32	32	170	27	SNM. 1506..	APL-04	ALV-04-M8x22	AASN-3-0023	AAY-03	-	-	AAL-05-4
3232 P19C	●	●	32	32	170	27								
4040 S19C	●	●	40	40	250	35								
4040 S25C	●	○	40	40	250	35	SNM. 1906..	APL-05	ALV-05-M10x27	AASN-3-0005	AAY-04	ACK-09	AAV-05-M6x15	AAL-05-4
5050 S25C	○	○	50	50	250	43								
SNM. 2509..							APL-06	ALV-06-M12x36	AASN-3-0020	AAY-05	ACK-04	AKV-16-M6x16	AAL-07-5	

R: Sağ/Right L: Sol/Left ● Stokta/In Stock ○ Stokta Yok/Non Stock Item

Sipariş Örneği/Ordering Example : 1 ad./pcs. PDN1616 H11

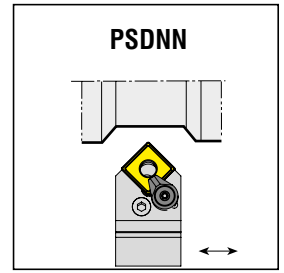
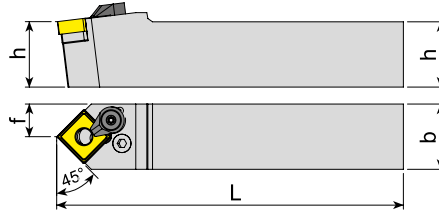

Takım Kodu Ordering Code	Stok Stock	Takım Ölçüleri (mm) Dimension (mm)				Kesici Uç Insert	Yedek Parçaları Spare Parts						
		h	b	L	f		Levyeye	Levyeye Vidası	Altılık	Altılık Yayı	Baskı Parçası	Baskı Vidası	Anahtar
							Lever	Lever Screw	Shim	Shim Spring	Wedge Clamp	Clamp Screw	Allen Key
PSDNN 1616 H09	●	16	16	100	8	SNM. 0903..	APL-01	ALV-02-M6x17	AASN-2-0002	AAY-01	-	-	AAL-02-2.5
2020 K12C	●	20	20	125	10	SNM. 1204..	APL-02	ALV-03-M8x19	AASN-3-0004	AAY-02	ACK-05	1515-M4x11	AAL-03-3
2525 M12C	●	25	25	150	12.5								
3232 P12C	●	32	32	170	16								
2020 K15C	○	20	20	125	10	SNM. 1506..	APL-04	ALV-04-M8x22	AASN-3-0023	AAY-03	ACK-09	AAV-05-M6x15	AAL-05-4
2525 M15C	●	25	25	150	12.5								
3232 P19C	●	32	32	170	16								
4040 S19C	○	40	40	250	20	SNM. 1906..	APL-05	ALV-05-M10x27	AASN-3-0005	AAY-04	ACK-09	AAV-05-M6x15	AAL-05-4
5050 S19C	○	50	50	250	25								
4040 S25C	●	40	40	250	20	SNM. 2509..	APL-06	ALV-06-M12x36	AASN-3-0020	AAY-05	ACK-04	AKV-16-M6x16	AAL-07-5
5050 S25C	○	50	50	250	25								

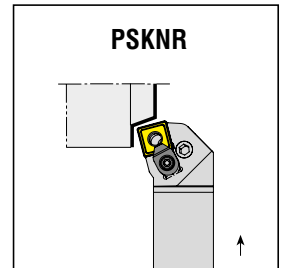
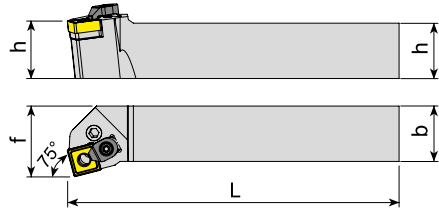

Takım Kodu Ordering Code	Stok Stock		Takım Ölçüleri (mm) Dimension (mm)				Kesici Uç Insert	Yedek Parçaları Spare Parts						
	R	L	h	b	L	f		Levyeye	Levyeye Vidası	Altılık	Altılık Yayı	Baskı Parçası	Baskı Vidası	Anahtar
								Lever	Lever Screw	Shim	Shim Spring	Wedge Clamp	Clamp Screw	Allen Key
PSKNR/L 2020 K09	●	○	20	20	125	25	SNM. 0903..	APL-01	ALV-02-M6x17	AASN-2-0002	AAY-01	-	-	AAL-02-2.5
2020 K12C	●	●	20	20	125	25	SNM. 1204..	APL-02	ALV-03-M8x19	AASN-3-0004	AAY-02	ACK-05	1515-M4x11	AAL-03-3
2525 M12C	●	●	25	25	150	32								
3232 P12C	●	●	32	32	170	40								
2525 M15C	●	●	25	25	150	32	SNM. 1506..	APL-04	ALV-04-M8x22	AASN-3-0023	AAY-03	ACK-09	AAV-05-M6x15	AAL-05-4
3232 P15C	●	○	32	32	170	40								
3232 P19C	●	○	32	32	170	40								
4040 S19C	●	○	40	40	250	50	SNM. 1906..	APL-05	ALV-05-M10x27	AASN-3-0005	AAY-04	ACK-09	AAV-05-M6x15	AAL-05-4
4040 S25C	●	○	40	40	250	50								
5050 S25C	●	○	50	50	250	60	SNM. 2509..	APL-06	ALV-06-M12x36	AASN-3-0020	AAY-05	ACK-04	AKV-16-M6x16	AAL-07-5

R: Sağ/Right L: Sol/Left ● Stokta/In Stock ○ Stokta Yok/Non Stock Item

Sipariş Örneği/Ordering Example : 1 ad./pcs. PSDNN 1616 H09

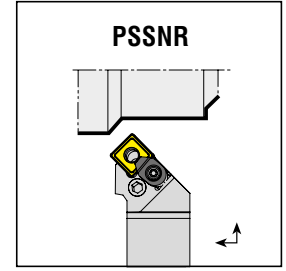
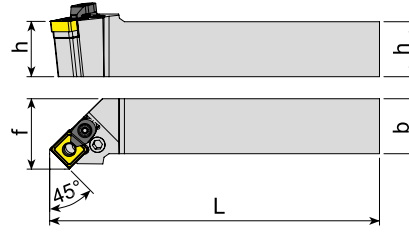

Takım Kodu Ordering Code	Stok Stock		Takım Ölçüleri (mm) Dimension (mm)				Kesici Uç Insert	Yedek Parçaları Spare Parts						
	R	L	h	b	L	f		Levye Lever	Levye Vidası Lever Screw	Altlık Shim	Altlık Yayı Shim Spring	Baskı Parçası Wedge Clamp	Baskı Vidası Clamp Screw	Anahtar Allen Key
PSSNR/L 1616 H09	●	●	16	16	100	20	SNM. 0903..	APL-01	ALV-02-M6x17	AASN-2-0002	AAV-01	-	-	AAL-02-2.5
2020 K09	●	○	20	20	125	25								
2020 K12C	●	●	20	20	125	25	SNM. 1204..	APL-02	ALV-03-M8x19	AASN-3-0004	AAV-02	ACK-05	1515-M4x11	AAL-03-3
2525 M12C	●	●	25	25	150	32								
3232 P12C	●	●	32	32	170	40	SNM. 1506..	APL-04	ALV-04-M8x22	AASN-3-0023	AAV-03	ACK-09	AAV-05-M6x15	AAL-05-4
3232 P15C	○	○	32	32	170	40								
3232 P19C	●	●	32	32	170	40	SNM. 1906..	APL-05	ALV-05-M10x27	AASN-3-0005	AAV-04	ACK-04	AKV-16-M6x16	AAL-07-5
4040 S19C	●	●	40	40	250	50								
4040 S25C	●	●	40	40	250	50	SNM. 2509..	APL-06	ALV-06-M12x36	AASN-3-0020	AAV-05	ACK-04	AKV-16-M6x16	AAL-07-5

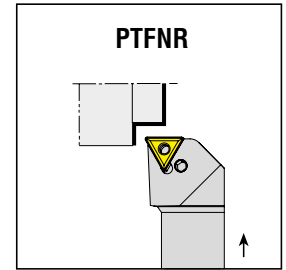
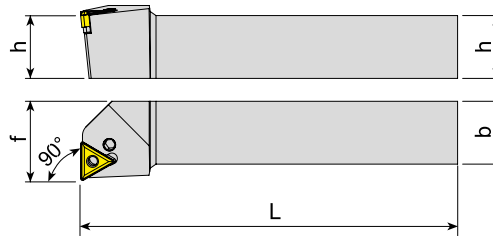

Takım Kodu Ordering Code	Stok Stock		Takım Ölçüleri (mm) Dimension (mm)				Kesici Uç Insert	Yedek Parçaları Spare Parts						
	R	L	h	b	L	f		Levye Lever	Levye Vidası Lever Screw	Altlık Shim	Altlık Yayı Shim Spring	Baskı Parçası Wedge Clamp	Baskı Vidası Clamp Screw	Anahtar Allen Key
PTFNR/L 1616 H16	●	●	16	16	100	20	TNM. 1604..	APL-01	ALV-02-M6x17	AATN-3-0025	AAV-01	-	-	AAL-02-2.5
2020 K16	●	●	20	20	125	25								
2525 M16	●	●	25	25	150	32								
3232 P16	●	●	32	32	170	40	TNM. 2204..	APL-02	ALV-03-M8x19	AATN-3-0015	AAV-02	ACK-05	1515-M4x11	AAL-03-3
2525 M22C	●	●	25	25	150	32								
3232 P22C	●	●	32	32	170	40	TNM. 2706.	07042709	07042710	07042701	07042711	-	-	AAL-05-4
4040 S27	○	○	40	40	250	50								

R: Sağ/Right L: Sol/Left ● Stokta/In Stock ○ Stokta Yok/Non Stock Item

Sipariş Örneği/Ordering Example : 1 ad./pcs. PSSNR 1616 H09

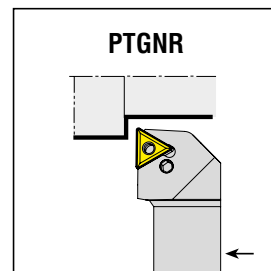
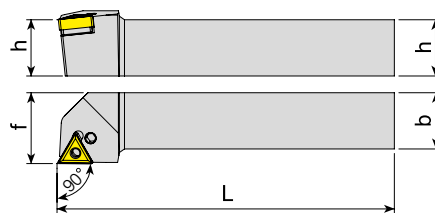

Takım Kodu Ordering Code	Stok Stock		Takım Ölçüleri (mm) Dimension (mm)				Kesici Uç Insert	Yedek Parçaları Spare Parts							
	R	L	h	b	L	f		Levye Lever	Levye Vidası Lever Screw	Altlık Shim	Altlık Yayı Shim Spring	Baskı Parçası Wedge Clamp	Baskı Vidası Clamp Screw	Anahtar Allen Key	
PTGNR/L 1010 E11	○	○	10	10	70	12			07041109	07041110	-	-	-	-	-
1212 F11	○	○	12	12	80	16									
1616 H11	○	○	16	16	100	20									
1616 H16	●	●	16	16	100	20	TNM. 1604..	APL-01	ALV-02-M6x17	AATN-3-0025	AAY-01	-	-	-	AAL-02-2.5
2020 K16	●	●	20	20	125	25									
2525 M16	●	●	25	25	150	32									
3232 P16	○	○	32	32	170	40	TNM. 2204..	APL-02	ALV-03-M8x19	AATN-3-0015	AAY-02	ACK-05	1515-M4x11	AAL-03-3	
2525 M22C	●	●	25	25	150	32									
3232 P22C	●	●	32	32	170	40									
4040 S27	○	○	40	40	250	50	TNM. 2706..	07042709	07042710	07042701	07042711	-	-	AAL-05-4	

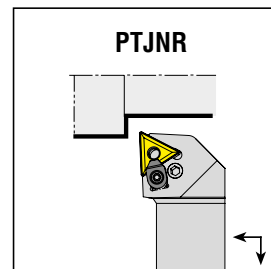
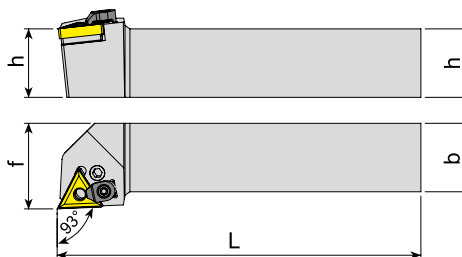

Takım Kodu Ordering Code	Stok Stock		Takım Ölçüleri (mm) Dimension (mm)				Kesici Uç Insert	Yedek Parçaları Spare Parts							
	R	L	h	b	L	f		Levye Lever	Levye Vidası Lever Screw	Altlık Shim	Altlık Yayı Shim Spring	Baskı Parçası Wedge Clamp	Baskı Vidası Clamp Screw	Anahtar Allen Key	
PTJNR/L 1010 E11	○	○	10	10	70	12			07041109	07041110	-	-	-	-	-
1212 F11	○	○	12	12	80	16									
1616 H11	○	○	16	16	100	20									
1616 H16	●	●	16	16	100	20	TNM. 1604..	APL-01	ALV-02-M6x17	AATN-3-0025	AAY-01	-	-	-	AAL-02-2.5
2020 K16	●	●	20	20	125	25									
2525 M16	●	●	25	25	150	32									
3232 P16	○	○	32	32	170	40	TNM. 2204..	APL-02	ALV-03-M8x19	AATN-3-0015	AAY-02	ACK-5	1515-M4x11	AAL-03-3	
2525 M22C	●	●	25	25	150	32									
3232 P22C	●	●	32	32	170	40									
4040 S27	○	○	40	40	250	50	TNM. 2706..	07042709	07042710	07042701	07042711	-	-	AAL-05-4	

R: Sağ/Right L: Sol/Left ● Stokta/In Stock ○ Stokta Yok/Non Stock Item

Sipariş Örneği/Ordering Example : 1 ad./pcs. PTGNR 1010 E11

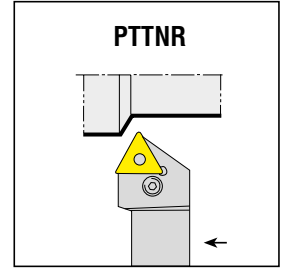
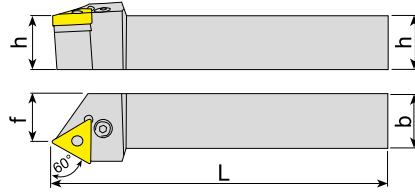

Takım Kodu Ordering Code	Stok Stock		Takım Ölçüleri (mm) Dimension (mm)				Kesici Uç Insert	Yedek Parçaları Spare Parts						
	R	L	h	b	L	f		Levyeye	Levyeye	Altılık	Altılık	Baskı	Baskı	Anahtar
								Lever	Lever Screw	Shim	Shim Spring	Wedge Clamp	Clamp Screw	Allen Key
PTTNR/L 1616 H16	●	●	16	16	100	13						-	-	AAL-02-2.5
2020 K16	●	●	20	20	125	17								
2525 M16	●	●	25	25	150	21.5								
3232 P16	●	●	32	32	170	31								
2525 M22C	●	●	25	25	150	20.5						ACK-05	1515-M4x11	AAL-03-3
3232 P22C	●	●	32	32	170	29								

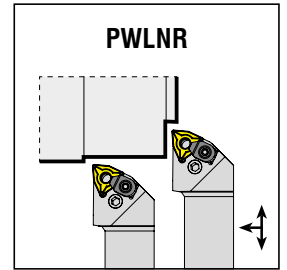
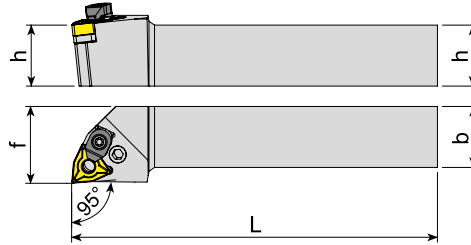

Takım Kodu Ordering Code	Stok Stock		Takım Ölçüleri (mm) Dimension (mm)				Kesici Uç Insert	Yedek Parçaları Spare Parts						
	R	L	h	b	L	f		Levyeye	Levyeye	Altılık	Altılık	Baskı	Baskı	Anahtar
								Lever	Lever Screw	Shim	Shim Spring	Wedge Clamp	Clamp Screw	Allen Key
PWLNR/L 1616 H06	●	●	16	16	100	20						-	-	AAL-02-2.5
2020 K06	●	●	20	20	125	25								
2525 M06	●	●	25	25	150	32								
3232 P06	○	○	32	32	170	40								
1616 H08	●	●	16	16	100	20						ACK-05	1515-M4x11	AAL-03-3
2020 K08C	●	●	20	20	125	25								
2525 M08C	●	●	25	25	150	32								
3232 P08C	●	●	32	32	170	40								

R: Sağ/Right L: Sol/Left ● Stokta/In Stock ○ Stokta Yok/Non Stock Item

Sipariş Örneği/Ordering Example : 1 ad./pcs. PTTNR 1616 H16

***konusulan**
the spoken kalite...
quality...*





*konusulan
the spoken kalite...
quality...*

C-SİSTEM

C-SİSTEM DIŞ TORNA KATERLERİ

C-SYSTEM EXTERNAL TURNING TOOLHOLDERS



www.akkо.com.tr

Дистрибьютер ООО "Ресурс Плюс"
+7 (351) 247-74-40; info@rp-ural.ru

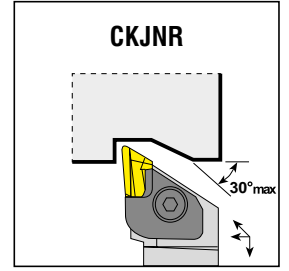
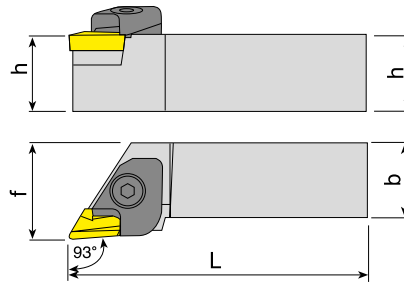

Takım Kodu Ordering Code	Stok Stock		Takım Ölçüleri (mm) Dimension (mm)				Kesici Uç Insert	Yedek Parçaları Spare Parts													
	R	L	h	b	L	f		Baskı Pabucu Wedge Clamp	Pabuç Vidası Clamp Screw	Altlık Shim	Altlık Vidası Shim Screw	Yay Spring	Pul Stamp	Anahtar Allen Key							
CKJNR/L 2020 K16	●	●	20	20	125	27.5	KNUX 1604..														
2525 M16	●	●	25	25	150	31.5									ACK-01-R	AKV-06-M6x20	AKS-16-R	AAV-01-M3x10	AKY-02	ABPL-01	AAL-05-4
3232 P16	●	●	32	32	170	40									ACK-02-L		AKS-16-L				
4040 S16	●	●	40	40	250	50															

C-SİSTEM SERAMİK UÇLAR İÇİN DIŞ TORNA KATERLERİ
C-SYSTEM EXTERNAL TURNING TOOLHOLDERS FOR CERAMIC INSERTS

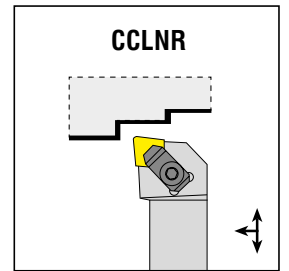
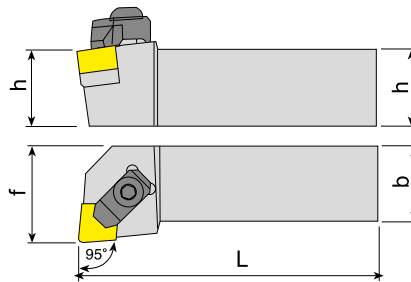

Takım Kodu Ordering Code	Stok Stock		Takım Ölçüleri (mm) Dimension (mm)				Kesici Uç Insert	Yedek Parçaları Spare Parts											
	R	L	h	b	L	f		Baskı Pabucu Wedge Clamp	Pabuç Vidası Clamp Screw	Altlık Shim	Altlık Vidası Shim Screw	Sekman Ring	Anahtar Allen Key						
CCLNR/L 2525 M1207C	●	●	25	25	150	32	CN.N 1207..												
3232 P1207C	●	●	32	32	170	40								ACK-13	AKV-11-M8x29	AACN-3-0001	AAV-02-M5x12	ACS-01	AAL-05-4
2525 M1607C	●	●	25	25	150	32								ACK-13	AKV-11-M8x29	AACN-3-0002	AAV-05-M6x15	ACS-01	AAL-05-4

R: Sağ/Right L: Sol/Left ● Stokta/In Stock ○ Stokta Yok/Non Stock Item

Sipariş Örneği/Ordering Example : 1 ad./pcs. CKJNR 2020 K16

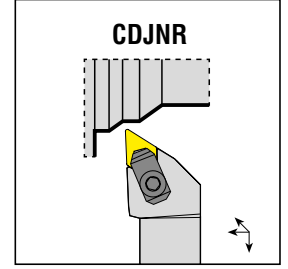
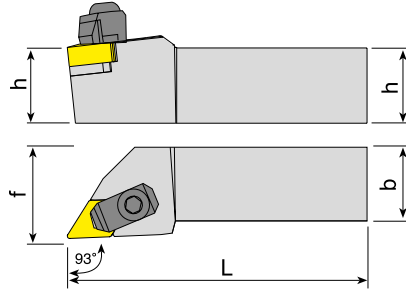

Takım Kodu Ordering Code	Stok Stock		Takım Ölçüleri (mm) Dimension (mm)				Kesici Uç Insert	Yedek Parçaları Spare Parts					
	R	L	h	b	L	f		Baskı Pabucu Wedge Clamp	Pabuç Vidası Clamp Screw	Altık Shim	Altık Vidası Shim Screw	Sekman Ring	Anahtar Allen Key
CDJNR/L 2525 M1107C	●	●	25	25	150	32	DN.N 1107..	ACK-22	AKV-11-M8x29	AADN-2-0001	AAV-04-M5x12	ACS-01	AAL-05-4
2525 M1507C	●	●	25	25	150	32	DN.N 1507..	ACK-13	AKV-11-M8x29	AADN-3-0001	AAV-02-M5x12	ACS-01	AAL-05-4
3232 P1507C	●	●	32	32	170	40							

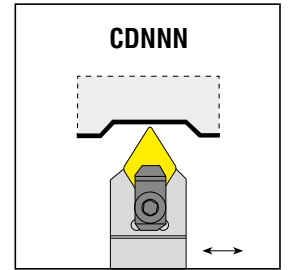
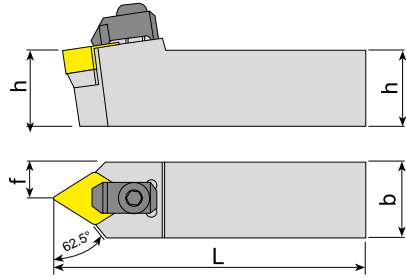

Takım Kodu Ordering Code	Stok Stock		Takım Ölçüleri (mm) Dimension (mm)				Kesici Uç Insert	Yedek Parçaları Spare Parts					
	R	L	h	b	L	f		Baskı Pabucu Wedge Clamp	Pabuç Vidası Clamp Screw	Altık Shim	Altık Vidası Shim Screw	Sekman Ring	Anahtar Allen Key
CDNNN 2525 M1107C	●		25	25	150	12.5	DN.N 1107..	ACK-22	AKV-11-M8x29	AADN-2-0001	AAV-04-M5x12	ACS-01	AAL-05-4

R: Sağ/Right L: Sol/Left ● Stokta/In Stock ○ Stokta Yok/Non Stock Item

Sipariş Örneği/Ordering Example : 1 ad./pcs. CDJNR 2525 M1507C

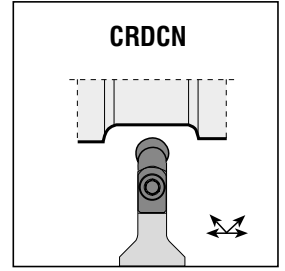
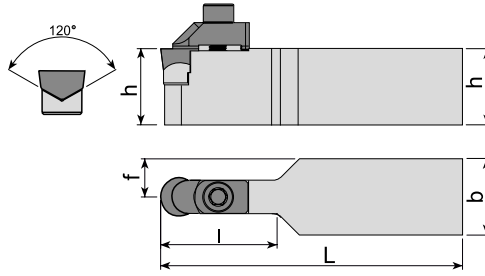

Takım Kodu Ordering Code	Stok Stock	Takım Ölçüleri (mm) Dimension (mm)					Kesici Uç Insert	Yedek Parçaları Spare Parts				
		h	b	L	l	f		Baskı Pabucu Wedge Clamp	Pabuç Vidası Clamp Screw	Altık Shim	Altık Vidası Shim Screw	Anahtar Allen Key
CRDCN 2525 M06CV	●	25	25	150	19	12.5	RCGX 060600	ACK-27	2525-M3X14	AARC-3-0001	3007-M2.2X5	AAL-02-2.5
3225 P06CV	●	32	25	170	19	12.5						
4040 S06CV	●	40	40	250	19	20						
2525 M09CV	●	25	25	150	29	12.5	RCGX 090700	ACK-28	2504-M5X16	AARC-3-0002	3008-M2.5x6	AAL-05-4
3225 P09CV	●	32	25	170	29	12.5						
4040 S09CV	●	40	40	250	29	20						
2525 M12CV	●	25	25	150	38	12.5	RCGX 120700	ACK-29	2505-M6X20	AARC-3-0003	3008-M2.5x6	AAL-07-5
3225 P12CV	●	32	25	170	38	12.5						
4040 S12CV	●	40	40	250	38	20						

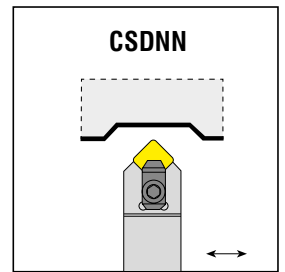
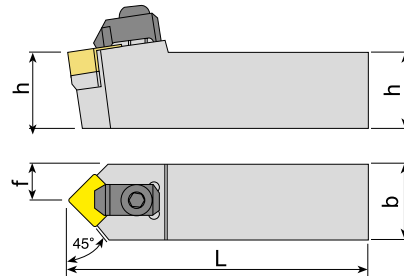

Takım Kodu Ordering Code	Stok Stock	Takım Ölçüleri (mm) Dimension (mm)				Kesici Uç Insert	Yedek Parçaları Spare Parts					
		h	b	L	f		Baskı Pabucu Wedge Clamp	Pabuç Vidası Clamp Screw	Altık Shim	Altık Vidası Shim Screw	Sekman Ring	Anahtar Allen Key
CSDNN 2525 M1207C	●	25	25	150	12.5	SN.N 1207..	ACK-13	AKV-11-M8x29	AASN-3-0004	AAV-02-M5x12	ACS-01	AAL-05-4
3232 P1207C	●	32	32	170	16							

R: Sağ/Right L: Sol/Left ● Stokta/In Stock ○ Stokta Yok/Non Stock Item

Sipariş Örneği/Ordering Example : 1 ad./pcs. CRDCN 2525 M06CV

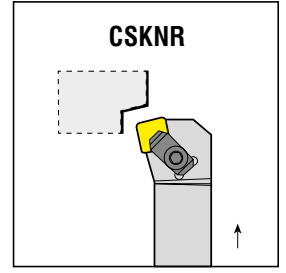
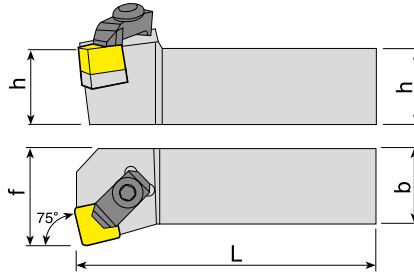
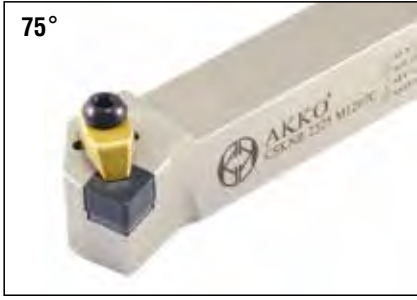

Takım Kodu Ordering Code	Stok Stock		Takım Ölçüleri (mm) Dimension (mm)				Kesici Uç Insert	Yedek Parçaları Spare Parts					
	R	L	h	b	L	f		Baskı Pabucu Wedge Clamp	Pabuç Vidası Clamp Screw	Altık Shim	Altık Vidası Shim Screw	Sekman Ring	Anahtar Allen Key
CSKNR/L 2525 M1207C	●	●	25	25	150	32	SN.N 1207..	ACK-13	AKV-11-M8x29	AASN-3-0004	AAV-02-M5x12	ACS-01	AAL-05-4
3232 P1207C	●	○	32	32	170	40							

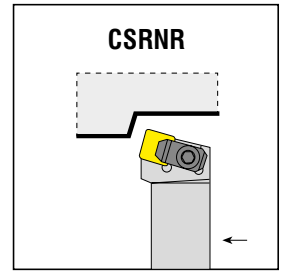
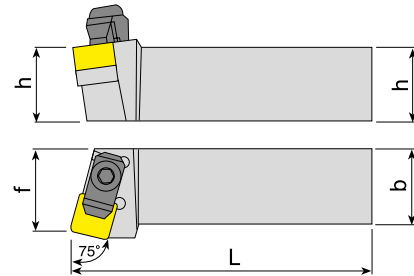

Takım Kodu Ordering Code	Stok Stock		Takım Ölçüleri (mm) Dimension (mm)				Kesici Uç Insert	Yedek Parçaları Spare Parts					
	R	L	h	b	L	f		Baskı Pabucu Wedge Clamp	Pabuç Vidası Clamp Screw	Altık Shim	Altık Vidası Shim Screw	Sekman Ring	Anahtar Allen Key
CSRNR/L 2525 M1207C	●	●	25	25	150	32	SN.N 1207..	ACK-13	AKV-11-M8x29	AASN-3-0004	AAV-02-M5x12	ACS-01	AAL-05-4
3232 P1207C	●	○	32	32	170	40							

R: Sağ/Right L: Sol/Left ● Stokta/In Stock ○ Stokta Yok/Non Stock Item

Sipariş Örneği/Ordering Example : 1 ad./pcs. CSKNR 2525 M1207C

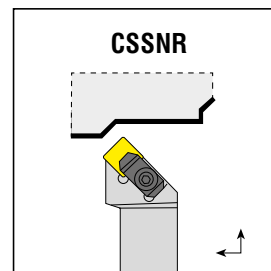
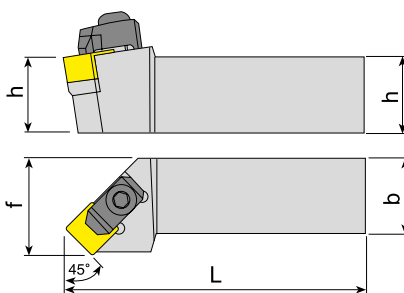

Takım Kodu Ordering Code	Stok Stock		Takım Ölçüleri (mm) Dimension (mm)				Kesici Uç Insert	Yedek Parçaları Spare Parts					
	R	L	h	b	L	f		Baskı Pabucu Wedge Clamp	Pabuç Vidası Clamp Screw	Altlık Shim	Altlık Vidası Shim Screw	Sekman Ring	Anahtar Allen Key
CSSNR/L 2525 M1207C	●	●	25	25	150	32	SN.N 1207..						
3232 P1207C	●	●	32	32	170	40							

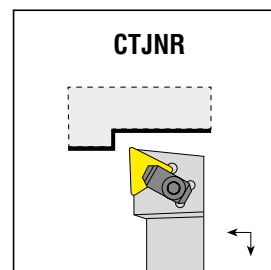
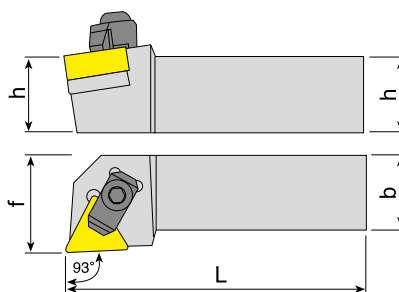

Takım Kodu Ordering Code	Stok Stock		Takım Ölçüleri (mm) Dimension (mm)				Kesici Uç Insert	Yedek Parçaları Spare Parts					
	R	L	h	b	L	f		Baskı Pabucu Wedge Clamp	Pabuç Vidası Clamp Screw	Altlık Shim	Altlık Vidası Shim Screw	Sekman Ring	Anahtar Allen Key
CTJNR/L 2525 M1607C	●	●	25	25	150	32	TN.N 1607..						
3232 P1607C	○	○	32	32	170	40							

R: Sağ/Right L: Sol/Left ● Stokta/In Stock ○ Stokta Yok/Non Stock Item

Sipariş Örneği/Ordering Example : 1 ad./pcs. CSSNR 2525 M1207C



*konusulan
the spoken kalite...
quality...*

S-SİSTEM

S-SİSTEM DIŞ TORNA KATERLERİ

S-SYSTEM EXTERNAL TURNING TOOLHOLDERS



www.akkocom.tr

Дистрибьютер ООО "Ресурс Плюс"
+7 (351) 247-74-40; info@rp-ural.ru

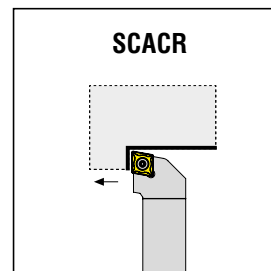
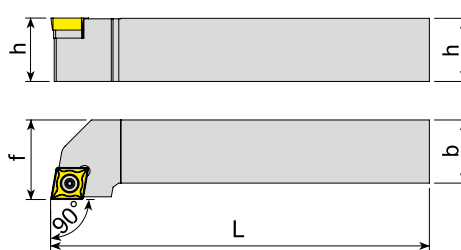

Takım Kodu Ordering Code	Stok Stock		Takım Ölçüleri (mm) Dimension (mm)				Kesici Uç Insert	Yedek Parçaları Spare Parts			
	R	L	h	b	L	f		Sıkma Vidası Screw	Altlık Shim	Altlık Vidası Shim Screw	Tork Anahtar Torx Key
SCACR/L 0808 E06	●	●	08	08	70	10	CCM. 0602..	4008-M2.5x6	-	-	80-T08
1010 E06	●	●	10	10	70	12					
1212 F09	●	●	12	12	80	16					
1616 H09	●	●	16	16	100	20	CCM. 09T3..	4015-M3.5x11	AACN-2-0001	AAV-06-M3.5x11	80-T15
2020 K09	●	●	20	20	125	25					
2020 K12	●	●	20	20	125	25	CCM. 1204..	1020-M4.5x16	AACN-2-0003	AAV-07-M4.5x13	80-T20
2525 M12	●	●	25	25	150	32					

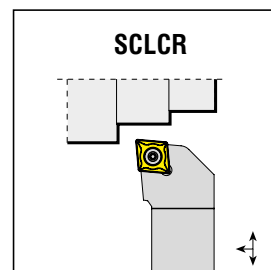
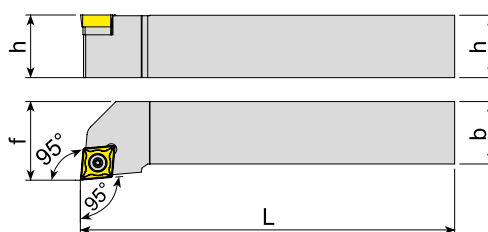

Takım Kodu Ordering Code	Stok Stock		Takım Ölçüleri (mm) Dimension (mm)				Kesici Uç Insert	Yedek Parçaları Spare Parts			
	R	L	h	b	L	f		Sıkma Vidası Screw	Altlık Shim	Altlık Vidası Shim Screw	Tork Anahtar Torx Key
SCLCR/L 0808 E06	●	●	08	08	70	10	CCM. 0602..	4008-M2.5x6	-	-	80-T08
1010 E06	●	●	10	10	70	12					
1212 F09	●	●	12	12	80	16					
1616 H09	●	●	16	16	100	20	CCM. 09T3..	4015-M3.5x11	AACN-2-0001	AAV-06-M3.5x11	80-T15
2020 K09	●	●	20	20	125	25					
2525 M09	●	●	25	25	150	32	CCM. 1204..	1020-M4.5x16	AACN-2-0003	AAV-07-M4.5x13	80-T20
2020 K12	●	●	20	20	125	25					
2525 M12	●	●	25	25	150	32					

R: Sağ/Right L: Sol/Left ● Stokta/In Stock ○ Stokta Yok/Non Stock Item

Sipariş Örneği/Ordering Example : 1 ad./pcs. SCACR 0808 E06

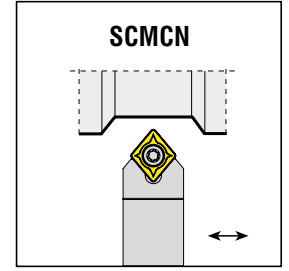
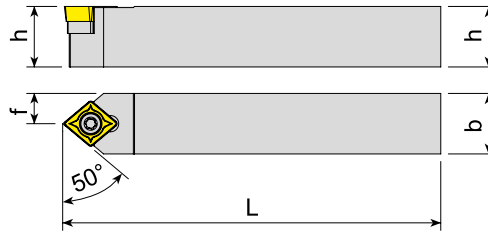

Takım Kodu Ordering Code	Stok Stock	Takım Ölçüleri (mm) Dimension (mm)				Kesici Uç Insert	Yedek Parçaları Spare Parts			
		h	b	L	f		Sıkma Vidası Screw	Aitlik Shim	Aitlik Vidası Shim Screw	Tork Anahtar Torx Key
SCMCN 0808 E06	●	08	08	70	04	CCM. 0602..	4008-M2.5x6	-	-	80-T08
1010 E06	●	10	10	70	05					
1212 F06	●	12	12	80	06					
1212 F09	●	12	12	80	06	CCM. 09T3..	4015-M3.5x11	-	-	80-T15
1616 H09	●	16	16	100	08					
2020 K12	●	20	20	125	10	CCM. 1204..	1020-M4.5x16	AACN-2-0001	AAV-06-M3.5x11	80-T20
2525 M12	●	25	25	150	12.5					

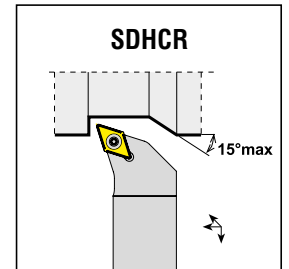
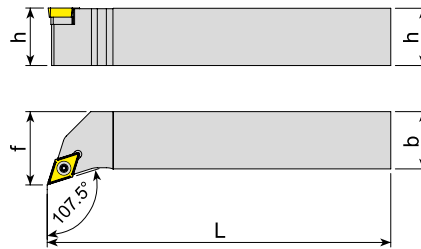

Takım Kodu Ordering Code	Stok Stock		Takım Ölçüleri (mm) Dimension (mm)				Kesici Uç Insert	Yedek Parçaları Spare Parts			
	R	L	h	b	L	f		Sıkma Vidası Screw	Aitlik Shim	Aitlik Vidası Shim Screw	Tork Anahtar Torx Key
SDHCR/L 0808 E07	●	●	08	08	70	11	DCM. 0702..	4008-M2.5x6	-	-	80-T08
1010 E07	●	●	10	10	70	12					
1212 F07	●	●	12	12	80	16					
1616 H07	●	●	16	16	100	20					
1616 H11	●	●	16	16	100	20	DCM. 11T3..	4015-M3.5x14	AADN-2-0001	AAV-06-M3.5x11	80-T15
2020 K11	●	●	20	20	125	25					
2525 M11	●	●	25	25	150	32					
3232 P11	●	●	32	32	170	40					

R: Sağ/Right L: Sol/Left ● Stokta/In Stock ○ Stokta Yok/Non Stock Item

Sipariş Örneği/Ordering Example : 1 ad./pcs. SCMCN 0808 E06

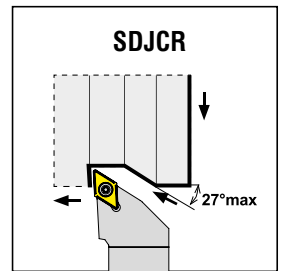
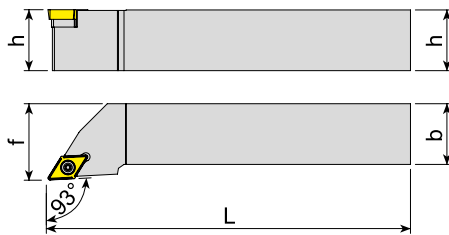
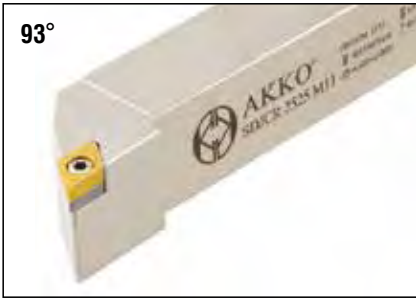

Takım Kodu Ordering Code	Stok Stock		Takım Ölçüleri (mm) Dimension (mm)				Kesici Uç Insert	Yedek Parçaları Spare Parts			
	R	L	h	b	L	f		Sıkma Vidası Screw	Aitlik Shim	Aitlik Vidası Shim Screw	Tork Anahtar Torx Key
SDJCR/L 0808 E07	●	●	08	08	70	10					
1010 E07	●	●	10	10	70	12					
1212 F07	●	●	12	12	80	16					
1616 H07	●	●	16	16	100	20					
1616 H11	●	●	16	16	100	20					
2020 K11	●	●	20	20	125	25					
2525 M11	●	●	25	25	150	32					
3232 P11	●	●	32	32	170	40					

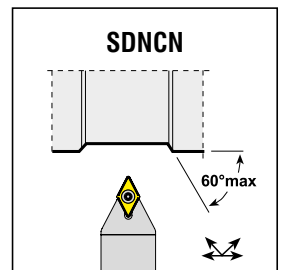
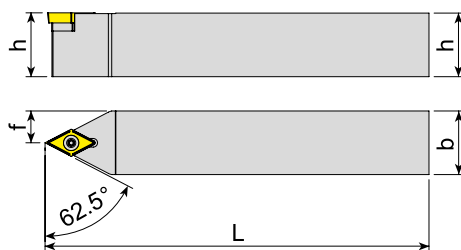

Takım Kodu Ordering Code	Stok Stock		Takım Ölçüleri (mm) Dimension (mm)				Kesici Uç Insert	Yedek Parçaları Spare Parts			
	R	L	h	b	L	f		Sıkma Vidası Screw	Aitlik Shim	Aitlik Vidası Shim Screw	Tork Anahtar Torx Key
SDNCN 0808 E07	●	●	08	08	70	4					
1010 E07	●	●	10	10	70	5					
1212 F07	●	●	12	12	80	6					
1616 H07	●	●	16	16	100	8					
1616 H11	●	●	16	16	100	8					
2020 K11	●	●	20	20	125	10					
2525 M11	●	●	25	25	150	12.5					
3232 P11	●	●	32	32	170	16					

R: Sağ/Right L: Sol/Left ● Stokta/In Stock ○ Stokta Yok/Non Stock Item

Sipariş Örneği/Ordering Example : 1 ad./pcs. SDJCR 0808 E07

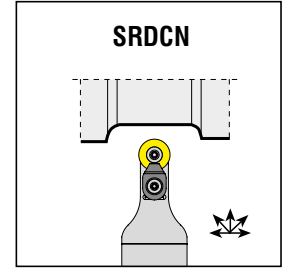
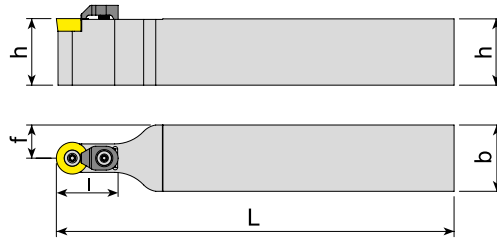

Takım Kodu Ordering Code	Stok Stock	Takım Ölçüleri (mm) Dimension (mm)					Kesici Uç Insert	Yedek Parçaları Spare Parts							
		h	b	L	l	f		Sıkma Vidası Screw	Aıtlık Shim	Aıtlık Vidası Shim Screw	Baskı Parçası Wedge Clamp	Baskı Vidası Clamp Screw	Tork Anahtar Torx Key		
SRDCN 1616 H06	●	16	16	100	15	8	RC.T 0602..	4008-M2.5x6	-	-	-	-	-	80-T08	
2020 K06	●	20	20	125	17	10									
2525 M06	●	25	25	150	17	12.5									
1616 H08C	●	16	16	100	15	8	RC.T 0803..	1008-M3x8	-	-	-	-	-		
2020 K08C	●	20	20	125	20	10									
2525 M08C	●	25	25	150	20	12.5									
1616 H10C	●	16	16	100	20	8	RC.T 10T3..	4015-M3.5x11	-	-	ACK-15	1015-M3.5x11	-		
2020 K10C	●	20	20	125	20	10									
2525 M10C	●	25	25	150	20	12.5									
3232 P10C	●	32	32	170	20	16	RC.T 1204..	4015-M3.5x11	-	-	-	-	80-T15		
2020 K12C	●	20	20	125	22	10									
2525 M12C	●	25	25	150	22	12.5									
3232 P12C	●	32	32	170	22	16	RC.T 1605..	1020-M5x11	-	-	ACK-05	1515-M4x11	-		
2525 M16C	●	25	25	150	32	12.5									
3232 P16C	●	32	32	170	35	16									
2525 M20C	●	25	25	150	32	12.5	RC.T 2006..	1420-M6x16	-	-	ACK-09	AAV-05-M6x15	80-T20		
3232 P20C	●	32	32	170	40	16									
3232 P25C	●	32	32	170	40	16									
3232 P32C	●	32	32	170	45	16	RC.T 2507..	1520-M6x16	-	-	-	-	-	-	
							RC.T 3209..	1904-M8x1x20	-	-	-	-	-	-	AAL-05-4

R: Sağ/Right L: Sol/Left ● Stokta/In Stock ○ Stokta Yok/Non Stock Item

Sipariş Örneği/Ordering Example : 1 ad./pcs. SRDCN 1616 H06



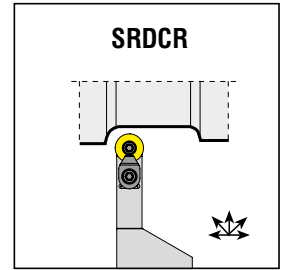
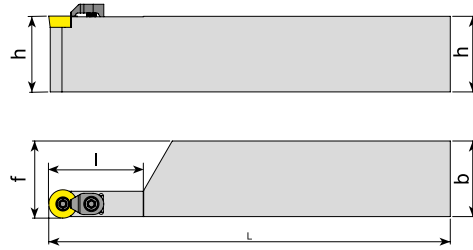

Takım Kodu Ordering Code	Stok Stock		Takım Ölçüleri (mm) Dimension (mm)				Kesici Uç Insert	Yedek Parçaları Spare Parts						
	R	L	h	b	L	l		f	Sıkma Vidası Screw	Altlık Shim	Altlık Vidası Shim Screw	Baskı Parçası Wedge Clamp	Baskı Vidası Clamp Screw	Tork Anahtar Torx Key
SRDCR/L 3232 P12C	●	●	32	32	170	40	32.6			-	-			

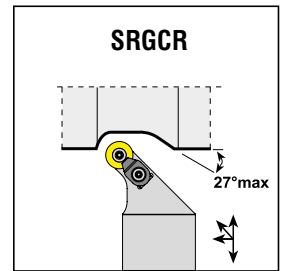
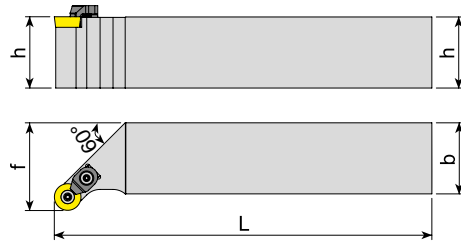

Takım Kodu Ordering Code	Stok Stock		Takım Ölçüleri (mm) Dimension (mm)				Kesici Uç Insert	Yedek Parçaları Spare Parts					
	R	L	h	b	L	f		Sıkma Vidası Screw	Altlık Shim	Altlık Vidası Shim Screw	Baskı Parçası Wedge Clamp	Baskı Vidası Clamp Screw	Tork Anahtar Torx Key
SRGCR/L 1616 H06	●	●	16	16	100	20	RC.T 0602..	4008-M2.5x6	-	-	-	-	80-T08
2020 K06	●	●	20	20	125	25							
1616 H08C	●	●	16	16	100	20	RC.T 0803..	1008-M3x8	-	-	ACK-15	1015-M3.5x11	80-T15
2020 K08C	●	●	20	20	125	25							
2525 M08C	●	●	25	25	150	32	RC.T 10T3..	4015-M3.5x11	-	-	ACK-05	1515-M4x11	80-T15
1616 H10C	●	●	16	16	100	20							
2020 K10C	●	●	20	20	125	25							
2525 M10C	●	●	25	25	150	32							
3232 P10C	●	●	32	32	170	40	RC.T 1204..	4015-M3.5x11	-	-	ACK-05	1515-M4x11	80-T15
2020 K12C	●	●	20	20	125	25							
2525 M12C	●	●	25	25	150	32							
3232 P12C	●	●	32	32	170	40							

R: Sağ/Right L: Sol/Left ● Stokta/In Stock ○ Stokta Yok/Non Stock Item

Sipariş Örneği/Ordering Example : 1 ad./pcs. SRDCR 3232 P12C

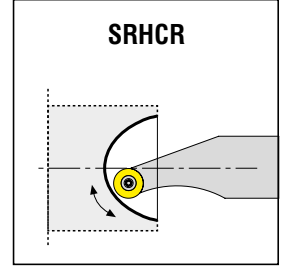
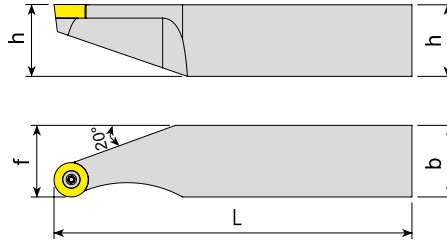

Takım Kodu Ordering Code	Stok Stock		Takım Ölçüleri (mm) Dimension (mm)				Kesici Uç Insert	Yedek Parçaları Spare Parts				
	R	L	h	b	L	f		Sıkma Vidası Screw	Altık Shim	Altık Vidası Shim Screw	Tork Anahtar Torx Key	
SRHCR/L 2525 K08	●	●	25	25	125	25	32.5	RCM. 0803..	1008-M3x8	-	-	80-T08
2525 K10	●	●	25	25	125	25	36	RCM. 10T3..	4015-M3.5x11	-	-	80-T15
2525 K12	●	●	25	25	125	25	40	RCM. 1204..		-	-	80-T15
2525 K16	●	●	25	25	125	25	47.5	RCM. 1606..	1020-M5x11	-	-	80-T20

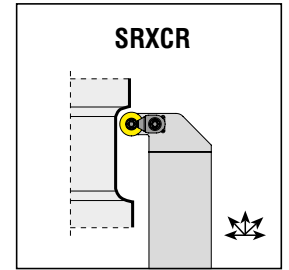
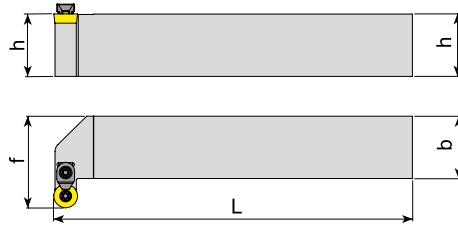

Takım Kodu Ordering Code	Stok Stock		Takım Ölçüleri (mm) Dimension (mm)				Kesici Uç Insert	Yedek Parçaları Spare Parts					
	R	L	h	b	L	f		Sıkma Vidası Screw	Altık Shim	Altık Vidası Shim Screw	Baskı Parçası Wedge Clamp	Baskı Vidası Clamp Screw	Tork Anahtar Torx Key
SRXCR/L 3232 X08C	●	●	32	32	220	47	RC.T 0803..	1008-M3x8	-	-	ACK-15	1015-M3.5x11	80-T08
3232 X10C	●	●	32	32	220	47	RC.T 10T3..	4015-M3.5x11	-	-			80-T15
3232 X12C	●	●	32	32	220	47	RC.T 1204..		-	-	ACK-05	1515-M4x11	80-T15

R: Sağ/Right L: Sol/Left ● Stokta/In Stock ○ Stokta Yok/Non Stock Item

Sipariş Örneği/Ordering Example : 1 ad./pcs. SRHCR 2525 K08

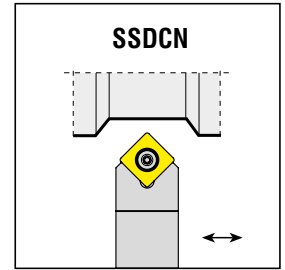
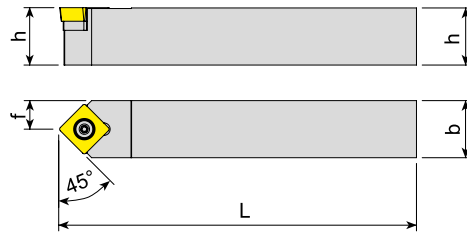

Takım Kodu Ordering Code	Stok Stock		Takım Ölçüleri (mm) Dimension (mm)				Kesici Uç Insert	Yedek Parçaları Spare Parts				
	R	L	h	b	L	f		Sıkma Vidası Screw	Altlık Shim	Altlık Vidası Shim Screw	Tork Anahtar Torx Key	
SSDCN 1212 F09	●		12	12	80	6			-	-		
1616 H09	●		16	16	100	8		SC.T 09T3..	4015-M3.5x14	AASN-2-0001		AAV-06-M3.5x11
2020 K09	●		20	20	125	10						
1616 H12	●		16	16	100	8				AAV-10-M4.5x8		
2020 K12	●		20	20	125	10		SC.T 1204..	1020-M4.5x16	AASN-2-0004		AAV-07-M4.5x13
2525 M12	●		25	25	150	12.5						

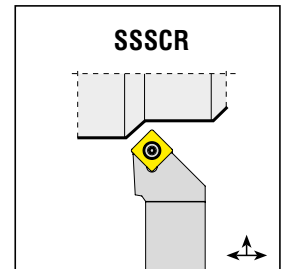
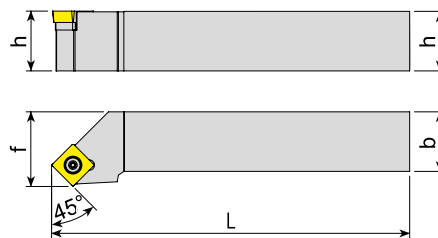

Takım Kodu Ordering Code	Stok Stock		Takım Ölçüleri (mm) Dimension (mm)				Kesici Uç Insert	Yedek Parçaları Spare Parts				
	R	L	h	b	L	f		Sıkma Vidası Screw	Altlık Shim	Altlık Vidası Shim Screw	Tork Anahtar Torx Key	
SSSCR/L 1212 F09	●	●	12	12	80	16			-	-		
1616 H09	●	●	16	16	100	20		SC.T 09T3..	4015-M3.5x14	AASN-2-0001		AAV-06-M3.5x11
2020 K09	●	●	20	20	125	25						
1616 H12	●	●	16	16	100	20				AAV-10-M4.5x8		
2020 K12	●	●	20	20	125	25		SC.T 1204..	1020-M4.5x16	AASN-2-0004		AAV-07-M4.5x13
2525 M12	●	●	25	25	150	32						

R: Sağ/Right L: Sol/Left ● Stokta/In Stock ○ Stokta Yok/Non Stock Item

Sipariş Örneği/Ordering Example : 1 ad./pcs. SSDCN 1212 F09

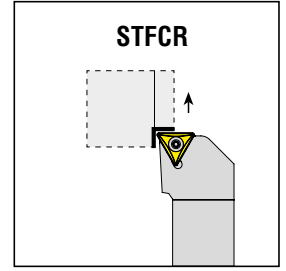
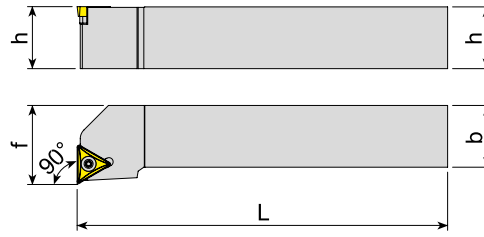

Takım Kodu Ordering Code	Stok Stock		Takım Ölçüleri (mm) Dimension (mm)				Kesici Uç Insert	Yedek Parçaları Spare Parts			
	R	L	h	b	L	f		Sıkma Vidası Screw	Altık Shim	Altık Vidası Shim Screw	Tork Anahtar Torx Key
	STFCR/L 0808 E09	○	○	08	08	70		10	TC.T 0902..	3007-M2.2x5	-
1010 E09	●	●	10	10	70	12					
1212 F11	●	●	12	12	80	16					
1616 H11	●	●	16	16	100	20	TC.T 1102..	4008-M2.5x6	-	-	80-T08
1616 H16	●	●	16	16	100	20					
2020 K16	●	●	20	20	125	25	TC.T 16T3..	4015-M3.5x14	AATN-2-0001	AAV-06-M3.5x11	80-T15
2525 M16	●	●	25	25	150	32					
3232 P16	●	●	32	32	170	40					

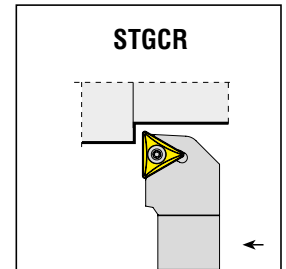
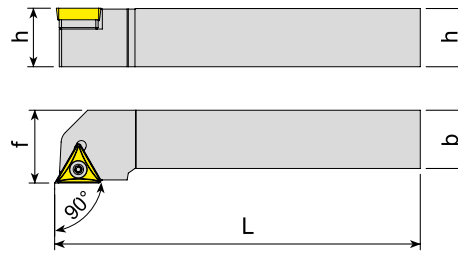

Takım Kodu Ordering Code	Stok Stock		Takım Ölçüleri (mm) Dimension (mm)				Kesici Uç Insert	Yedek Parçaları Spare Parts			
	R	L	h	b	L	f		Sıkma Vidası Screw	Altık Shim	Altık Vidası Shim Screw	Tork Anahtar Torx Key
	STGCR/L 0808 E09	●	●	08	08	70		10	TC.T 0902..	3007-M2.2x5	-
1010 E09	●	●	10	10	70	12					
1212 F11	●	●	12	12	80	16					
1616 H11	●	●	16	16	100	20	TC.T 1102..	4008-M2.5x6	-	-	80-T08
1616 H16	○	○	16	16	100	20					
2020 K16	●	●	20	20	125	25	TC.T 16T3..	4015-M3.5x14	AATN-2-0001	AAV-06-M3.5x11	80-T15
2525 M16	●	●	25	25	150	32					
3232 P16	●	●	32	32	170	40					

R: Sağ/Right L: Sol/Left ● Stokta/In Stock ○ Stokta Yok/Non Stock Item

Sipariş Örneği/Ordering Example : 1 ad./pcs. STFGR 0808 E09

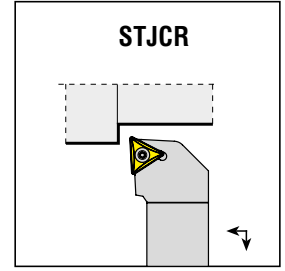
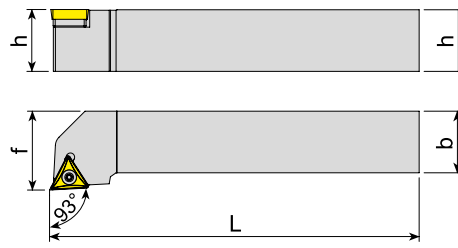

Takım Kodu Ordering Code	Stok Stock		Takım Ölçüleri (mm) Dimension (mm)				Kesici Uç Insert	Yedek Parçaları Spare Parts			
	R	L	h	b	L	f		Sıkma Vidası Screw	Altık Shim	Altık Vidası Shim Screw	Tork Anahtar Torx Key
STJCR/L 0808 E09	●	●	08	08	70	10	TC.T 0902..	3007-M2.2x5	-	-	80-T07
1010 E09	●	●	10	10	70	12					
1212 F11	●	●	12	12	80	16	TC.T 1102..	4008-M2.5x6	-	-	80-T08
1616 H11	●	●	16	16	100	20					
1616 H16	●	●	16	16	100	20	TC.T 16T3..	4015-M3.5x14	AATN-2-0001	AAV-06-M3.5x11	80-T15
2020 K16	●	●	20	20	125	25					
2525 M16	●	●	25	25	150	32					
3232 P16	●	●	32	32	170	40					

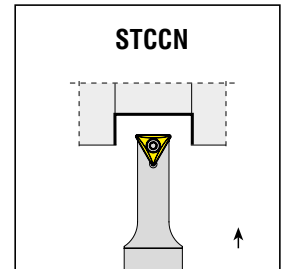
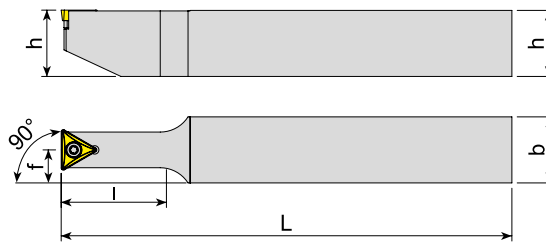

Takım Kodu Ordering Code	Stok Stock		Takım Ölçüleri (mm) Dimension (mm)					Kesici Uç Insert	Yedek Parçaları Spare Parts			
	R	L	h	b	L	f	l		Sıkma Vidası Screw	Altık Shim	Altık Vidası Shim Screw	Tork Anahtar Torx Key
STCCN 2020 L11	●		20	20	140	10	50	TC.T 1102..	4008-M2.5x6	-	-	80-T08
1616 K16	●		16	16	125	8	24					
2020 M16	●		20	20	150	10	30	TC.T 16T3..	4015-M3.5x14	AATN-2-0001	AAV-06-M3.5x11	80-T15
2525 P16	●		25	25	170	12.5	37.5					
3232 R16	●		32	32	200	16	48					
2525 P22	●		25	25	170	12.5	80					
								TC.T 2204..	4020-M4.5x12	-	-	80-T20

R: Sağ/Right L: Sol/Left ● Stokta/In Stock ○ Stokta Yok/Non Stock Item

Sipariş Örneği/Ordering Example : 1 ad./pcs. STJCR 0808 E09

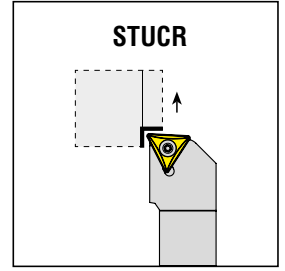
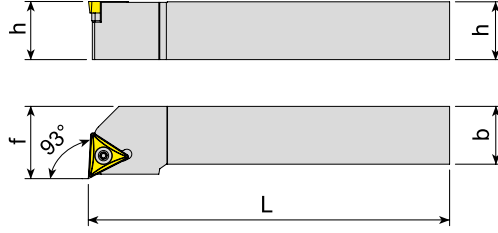

Takım Kodu Ordering Code	Stok Stock		Takım Ölçüleri (mm) Dimension (mm)				Kesici Uç Insert	Yedek Parçaları Spare Parts			
	R	L	h	b	L	f		Sıkma Vidası Screw	Altık Shim	Altık Vidası Shim Screw	Tork Anahtar Torx Key
	STUCR/L 0808 E09	●	●	08	08	70		10			
1010 E09	●	●	10	10	70	12					
1212 F11	●	●	12	12	80	16					
1616 H11	●	●	16	16	100	20	TC.T 1102..	4008-M2.5x6			80-T08
1616 H16	○	○	16	16	100	20					
2020 K16	●	●	20	20	125	25	TC.T 16T3..	4015-M3.5x14	AATN-2-0001	AAV-06-M3.5x11	80-T15
2525 M16	●	●	25	25	150	32					
3232 P16	●	●	32	32	170	40					

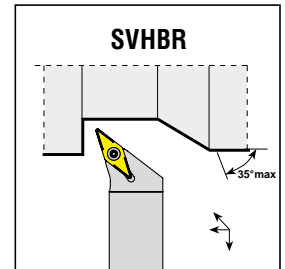
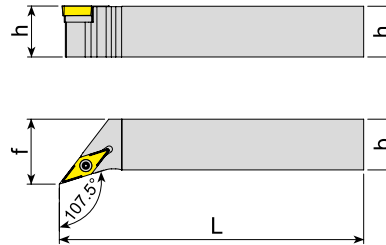

Takım Kodu Ordering Code	Stok Stock		Takım Ölçüleri (mm) Dimension (mm)				Kesici Uç Insert	Yedek Parçaları Spare Parts			
	R	L	h	b	L	f		Sıkma Vidası Screw	Altık Shim	Altık Vidası Shim Screw	Tork Anahtar Torx Key
	SVHBR/L 1212 F11	●	●	12	12	80		16			
1616 H11	●	●	16	16	100	20					
2020 K11	●	●	20	20	125	25					
2020 K16	●	●	20	20	125	25	VBM. 1604..	4015-M3.5x14	AAVN-2-0002	AAV-06-M3.5x11	80-T15
2525 M16	●	●	25	25	150	32					
3232 P16	●	●	32	32	170	40					

R: Sağ/Right L: Sol/Left ● Stokta/In Stock ○ Stokta Yok/Non Stock Item

Sipariş Örneği/Ordering Example : 1 ad./pcs. STUCR 0808 E09

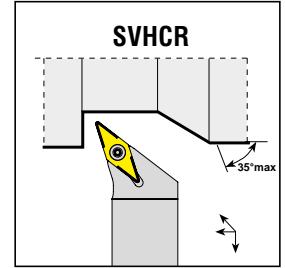
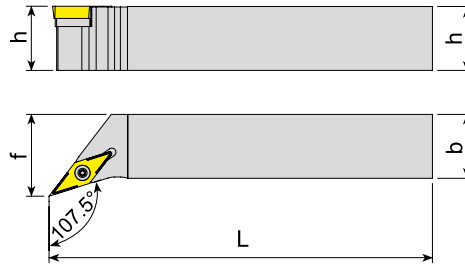

Takım Kodu Ordering Code	Stok Stock		Takım Ölçüleri (mm) Dimension (mm)				Kesici Uç Insert	Yedek Parçaları Spare Parts			
	R	L	h	b	L	f		Sıkma Vidası Screw	Altık Shim	Altık Vidası Shim Screw	Tork Anahtar Torx Key
	SVHCR/L 1212 F11	●	●	12	12	80		16	VC.T 1103..	4008-M2.5x6	-
1616 H11	●	●	16	16	100	20					
2020 K11	●	●	20	20	125	25					
2020 K16	●	●	20	20	125	25	VC.T 1604..	4015-M3.5x14	AAVN-2-0002	AAV-06-M3.5x11	80-T15
2525 M16	●	●	25	25	150	32					
3232 P16	●	●	32	32	170	40					

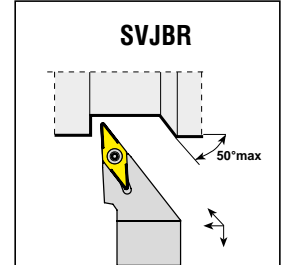
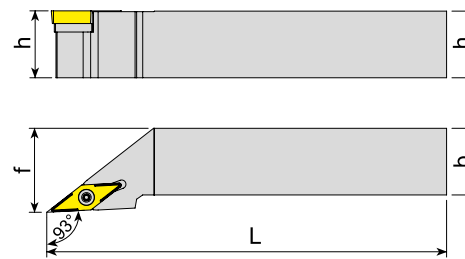

Takım Kodu Ordering Code	Stok Stock		Takım Ölçüleri (mm) Dimension (mm)				Kesici Uç Insert	Yedek Parçaları Spare Parts			
	R	L	h	b	L	f		Sıkma Vidası Screw	Altık Shim	Altık Vidası Shim Screw	Tork Anahtar Torx Key
	SVJBR/L 1212 F11	●	●	12	12	80		16	VBM. 1103..	4008-M2.5x6	-
1616 H11	●	●	16	16	100	20					
2020 K11	●	●	20	20	125	25					
1616 H16	●	●	16	16	100	20	VBM. 1604..	4015-M3.5x14	AAVN-2-0002	AAV-06-M3.5x11	80-T15
2020 K16	●	●	20	20	125	25					
2525 M16	●	●	25	25	150	32					
3232 P16	●	●	32	32	170	40					

R: Sağ/Right L: Sol/Left ● Stokta/In Stock ○ Stokta Yok/Non Stock Item

Sipariş Örneği/Ordering Example : 1 ad./pcs. SVHCR 1212 F11

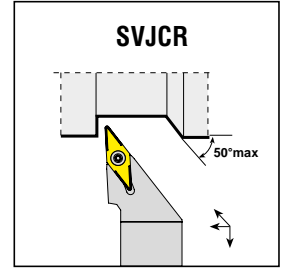
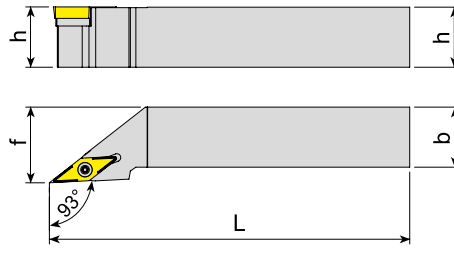

Takım Kodu Ordering Code	Stok Stock		Takım Ölçüleri (mm) Dimension (mm)				Kesici Uç Insert	Yedek Parçaları Spare Parts			
	R	L	h	b	L	f		Sıkma Vidası Screw	Altık Shim	Altık Vidası Shim Screw	Tork Anahtar Torx Key
SVJCR/L 1212 F11	●	●	12	12	80	16	VC.T 1103..	4008-M2.5x6	-	-	80-T08
1616 H11	●	●	16	16	100	20					
2020 K11	●	●	20	20	125	25					
1212 F16	●	○	12	12	80	16	VC.T 1604..	4015-M3.5x14	AAVN-2-0002	AAV-06-M3.5x11	80-T15
2020 K16	●	●	20	20	125	25					
2525 M16	●	●	25	25	150	32					
3232 P16	●	●	32	32	170	40					

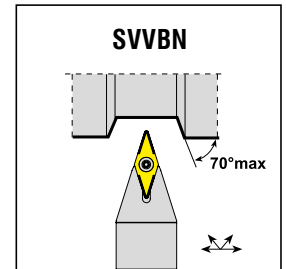
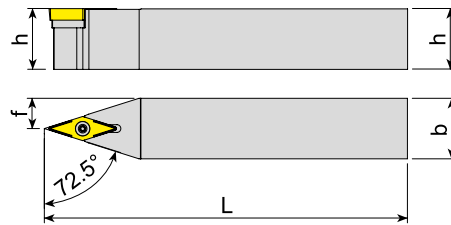

Takım Kodu Ordering Code	Stok Stock		Takım Ölçüleri (mm) Dimension (mm)				Kesici Uç Insert	Yedek Parçaları Spare Parts			
	R	L	h	b	L	f		Sıkma Vidası Screw	Altık Shim	Altık Vidası Shim Screw	Tork Anahtar Torx Key
SVVBN 1212 F11	●		12	12	80	06	VBM. 1103..	4008-M2.5x6	-	-	80-T08
1616 H11	●		16	16	100	08					
2020 K11	●		20	20	125	10					
2020 K16	●		20	20	125	10	VBM. 1604..	4015-M3.5x14	AAVN-2-0002	AAV-06-M3.5x11	80-T15
2525 M16	●		25	25	150	12.5					
3232 P16	●		32	32	170	16					

R: Sağ/Right L: Sol/Left ● Stokta/In Stock ○ Stokta Yok/Non Stock Item

Sipariş Örneği/Ordering Example : 1 ad./pcs. SVJCR 1212 F11

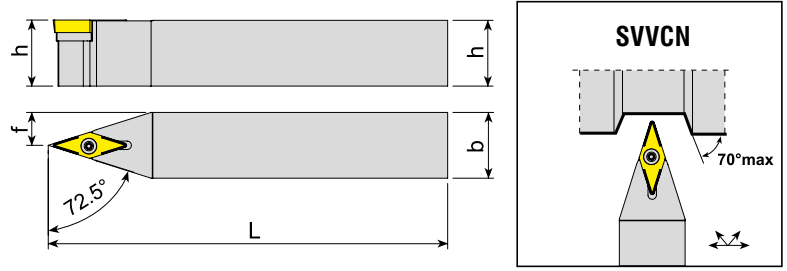

Takım Kodu Ordering Code	Stok Stock	Takım Ölçüleri (mm) Dimension (mm)				Kesici Uç Insert	Yedek Parçaları Spare Parts			
		h	b	L	f		Sıkma Vidası Screw	Altılık Shim	Altılık Vidası Shim Screw	Tork Anahtar Torx Key
SVVCN 1212 F11	●	12	12	80	06	VC.T 1103..	4008-M2.5x6	-	-	80-T08
1616 H11	●	16	16	100	08					
2020 K11	●	20	20	125	10					
2020 K16	●	20	20	125	10					
2525 M16	●	25	25	150	12.5	VC.T 1604..	4015-M3.5x14	AAVN-2-0002	AAV-06-M3.5x11	80-T15
3232 P16	●	32	32	170	16					

S-SİSTEM İSVİÇRE TİPİ KAYAR OTOMAT MAKİNA TAKIMLARI
S-SYSTEM TOOLS FOR SWISS TYPE SLIDING AUTOMATIC LATHES

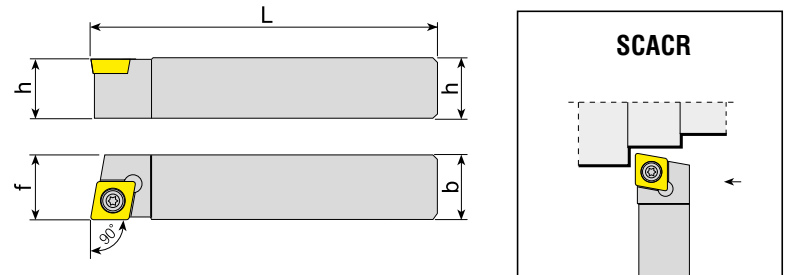

Takım Kodu Ordering Code	Stok Stock		Takım Ölçüleri (mm) Dimension (mm)				Kesici Uç Insert	Yedek Parçaları Spare Parts			
	R	L	h	b	L	f		Sıkma Vidası Screw	Altılık Shim	Altılık Vidası Shim Screw	Tork Anahtar Torx Key
SCACR/L 0808 X06-S	●	●	08	08	115	08	CCM. 0602..	4008-M2.5x6	-	-	80-T08
1010 K06-S	●	○	10	10	125	10					
1212 G06-S	●	○	12	12	90	12					
1212 K06-S	●	○	12	12	125	12					
1616 F06-S	○	○	16	16	75	16					
1616 K06-S	○	○	16	16	125	16					
1212 G09-S	○	○	12	12	90	12	CCM. 09T3..	4015-M3.5x11	-	-	80-T15
1212 K09-S	●	●	12	12	125	12					
1616 F09-S	○	○	16	16	75	16					
1616 K09-S	●	●	16	16	125	16					
2020 K09-S	●	●	20	20	125	20					

R: Sağ/Right L: Sol/Left ● Stokta/In Stock ○ Stokta Yok/Non Stock Item

Sipariş Örneği/Ordering Example : 1 ad./pcs. SVVCN 1212 F11

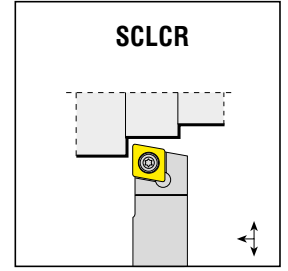
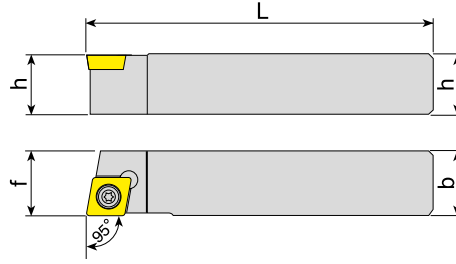

Takım Kodu Ordering Code	Stok Stock		Takım Ölçüleri (mm) Dimension (mm)				Kesici Uç Insert	Yedek Parçaları Spare Parts			
	R	L	h	b	L	f		Sıkma Vidası Screw	Altık Shim	Altık Vidası Shim Screw	Tork Anahtar Torx Key
	SCLCR/L 0808 X06-S	●	●	08	08	115		08	CCM. 0602..	4008-M2.5x6	-
1010 X06-S	●	○	10	10	115	10					
1212 G06-S	●	○	12	12	90	12					
1212 X06-S	●	○	12	12	130	12					
1616 F06-S	●	○	16	16	75	16					
1616 X06-S	●	○	16	16	130	16					
1212 G09-S	●	○	12	12	90	12	CCM. 09T3..	4015-M3.5x11	-	-	80-T15
1212 X09-S	●	○	12	12	130	12					
1616 F09-S	●	○	16	16	75	16					
1616 G09-S	●	○	16	16	90	16					
1616 X09-S	●	○	16	16	130	16					
2020 X09-S	●	○	20	20	120	20					

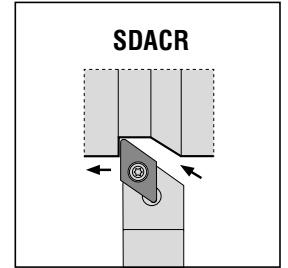
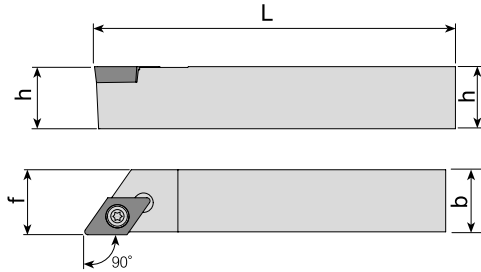

Takım Kodu Ordering Code	Stok Stock		Takım Ölçüleri (mm) Dimension (mm)				Kesici Uç Insert	Yedek Parçaları Spare Parts			
	R	L	h	b	L	f		Sıkma Vidası Screw	Altık Shim	Altık Vidası Shim Screw	Tork Anahtar Torx Key
	SDACR/L 0808 X07-S	●	●	08	08	115		08	DC.T 0702..	4008-M2.5x6	-
1010 K07-S	●	●	10	10	125	10					
1212 G07-S	○	○	12	12	90	12					
1212 K07-S	●	●	12	12	125	12					
1616 F07-S	○	○	16	16	75	16					
1616 K07-S	●	●	16	16	125	16					
1212 G11-S	○	○	12	12	90	12	DC.T 11T3..	4015-M3.5x11	-	-	80-T15
1212 K11-S	●	●	12	12	125	12					
1616 F11-S	●	○	16	16	75	16					
1616 K11-S	●	●	16	16	125	16					
2020 K11-S	●	●	20	20	125	20					

R: Sağ/Right L: Sol/Left ● Stokta/In Stock ○ Stokta Yok/Non Stock Item

Sipariş Örneği/Ordering Example : 1 ad./pcs. SCLCR 0808 X06-S



www.akk.com.tr

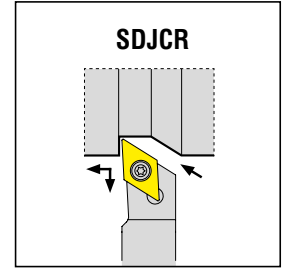
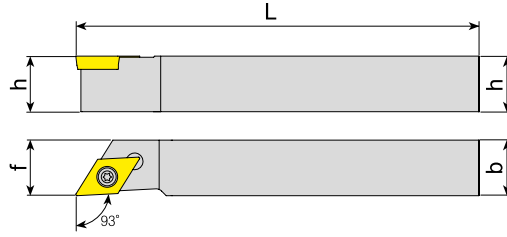

Takım Kodu Ordering Code	Stok Stock		Takım Ölçüleri (mm) Dimension (mm)				Kesici Uç Insert	Yedek Parçaları Spare Parts			
	R	L	h	b	L	f		Sıkma Vidası Screw	Altık Shim	Altık Vidası Shim Screw	Tork Anahtar Torx Key
SDJCR/L 0808 X07-S	●	○	08	08	115	08					80-T08
1010 X07-S	●	●	10	10	115	10					
1212 G07-S	●	○	12	12	90	12					
1212 X07-S	●	○	12	12	130	12					
1616 F07-S	●	○	16	16	75	16					
1616 X07-S	●	○	16	16	130	16					
2020 X07-S	●	○	20	20	120	20					
1212 G11-S	●	○	12	12	90	12					80-T15
1212 X11-S	●	●	12	12	130	12					
1212 K11-S	●	●	12	12	125	12					
1616 F11-S	●	○	16	16	75	16					
1616 X11-S	●	○	16	16	130	16					
1616 K11-S	●	●	16	16	125	16					
2020 X11-S	●	○	20	20	120	20					

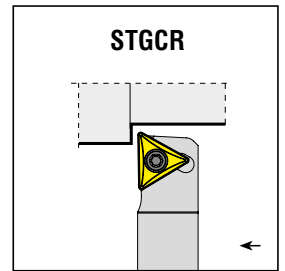
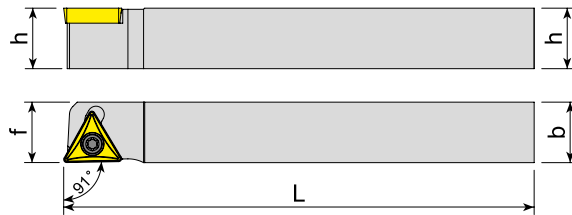





Takım Kodu Ordering Code	Stok Stock		Takım Ölçüleri (mm) Dimension (mm)				Kesici Uç Insert	Yedek Parçaları Spare Parts			
	R	L	h	b	L	f		Sıkma Vidası Screw	Altık Shim	Altık Vidası Shim Screw	Tork Anahtar Torx Key
STGCR/L 1216 K11-S	●	○	12	16	125	16					80-T08
1616 K11-S	●	○	16	16	125	16					
1216 K16-S	●	○	12	16	125	16					80-T15
1616 K16-S	●	○	16	16	125	16					

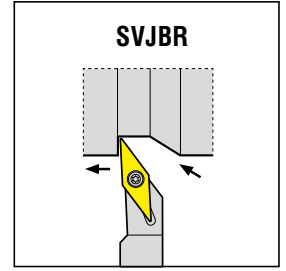
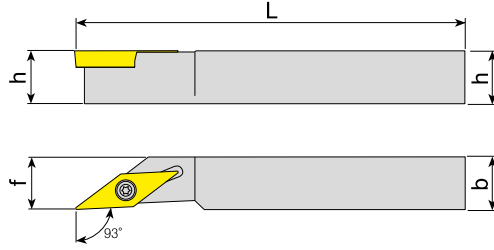



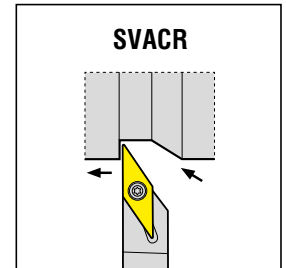
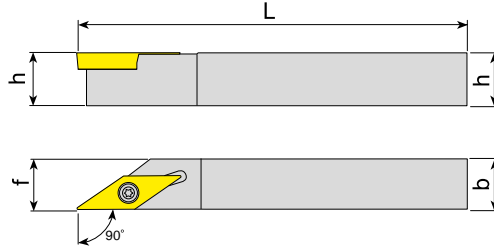

R: Sağ/Right L: Sol/Left ● Stokta/In Stock ○ Stokta Yok/Non Stock Item

Sipariş Örneği/Ordering Example : 1 ad./pcs. SDJCR 1212 K11-S



Takım Kodu Ordering Code	Stok Stock		Takım Ölçüleri (mm) Dimension (mm)				Kesici Uç Insert	Yedek Parçaları Spare Parts			
	R	L	h	b	L	f		Sıkma Vidası Screw	Altık Shim	Altık Vidası Shim Screw	Tork Anahtar Torx Key
SVJBR/L 1616 K11-S	●	●	16	16	125	16	 VBM. 1103..	 4008-M2.5x6	 -	 -	 80-T08

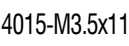

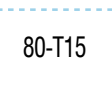
Takım Kodu Ordering Code	Stok Stock		Takım Ölçüleri (mm) Dimension (mm)				Kesici Uç Insert	Yedek Parçaları Spare Parts			
	R	L	h	b	L	f		Sıkma Vidası Screw	Altık Shim	Altık Vidası Shim Screw	Tork Anahtar Torx Key
SVACR/L 0808 X11-S	○	○	08	08	115	08	 VC.T 1103..	 4008-M2.5x6	 -	 -	 80-T08
1010 K11-S	●	○	10	10	125	10					
1212 G11-S	○	○	12	12	90	12					
1212 K11-S	●	●	12	12	125	12					
1616 F11-S	○	○	16	16	75	16					
1616 K11-S	●	●	16	16	125	16					
2020 K11-S	●	●	20	20	125	20					
1212 K16-S	●	●	12	12	125	12	 4015-M3.5x11	 -	 -	 80-T15	
1616 K16-S	●	●	16	16	125	16					

R: Sağ/Right L: Sol/Left ● Stokta/In Stock ○ Stokta Yok/Non Stock Item

Sipariş Örneği/Ordering Example : 1 ad./pcs. SVJBR 1616 K11-S

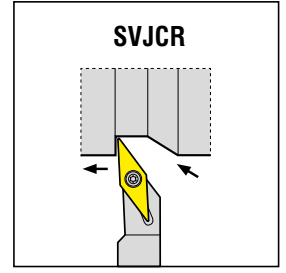
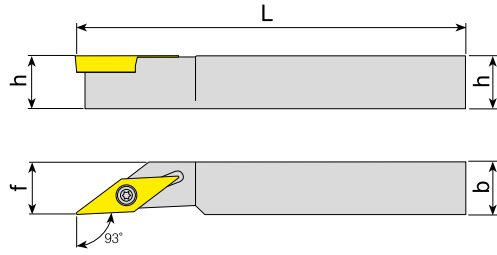

Takım Kodu Ordering Code	Stok Stock		Takım Ölçüleri (mm) Dimension (mm)				Kesici Uç Insert	Yedek Parçaları Spare Parts			
	R	L	h	b	L	f		Sıkma Vidası Screw	Aıtlık Shim	Aıtlık Vidası Shim Screw	Tork Anahtar Torx Key
SVJCR/L 0808 X11-S	●	○	08	08	115	08	VC.T 1103..	4008-M2.5x6	-	-	80-T08
1010 K11-S	○	○	10	10	125	10					
1212 G11-S	○	○	12	12	90	12					
1212 K11-S	●	●	12	12	125	12					
1616 F11-S	○	○	16	16	75	16					
1616 K11-S	○	○	16	16	125	16					
2020 K11-S	○	○	20	20	125	20					

R: Sağ/Right L: Sol/Left ● Stokta/In Stock ○ Stokta Yok/Non Stock Item

Sipariş Örneği/Ordering Example : 1 ad./pcs. SVJCR 0808 X11-S

