



КУЛАЧКИ

КУЛАЧКИ



КУЛАЧКИ

НЕЗАКАЛЕННЫЕ КУЛАЧКИ ДЛЯ МЕХАНИЗИРОВАННЫХ ПАТРОНОВ

серия **SB**



SB06A1-80

- Суммарная высота кулачков (высота стандартного кулачка не приводится)
- Число кулачков в комплекте: «-» = 3 шт; T = 2шт; Q = 4 шт.
- Шаг гребёнки: 1 = 1,5мм x 60° ; 2 = 3мм x 60°.
- Форма и характеристика кулачка:
 А - без среза вершины; В - со срезом вершины; L - легкий вес; N - новый тип.
 С - расстояние между болтами (в случае если расстояние между болтами различается при одинаковом диаметре патрона)
 Полный 4° = 15мм; Полный 5° = 18мм; 12° патрон = 38мм; 15° патрон = 43мм.
- Размер патрона
- Незакаленные кулачки

■ **Комбинации незакаленных кулачков (модели патронов в скобках сняты с производства)**

| Стандартные кулачки | Высокие кулачки | Патроны без сквозного отверстия | Патроны со сквозным отверстием |
|---------------------|------------------------------------|---|--|
| SB04C1 | SB04C1-036, SB04C1-048 | | (B-04, HOB-4) |
| SB04C1T | SB04C1T048 | | (BT04, HOBT-4) |
| SB04B1 | SB04A1-036, SB04A1-048 | N-04 (HJ-4), AS04, NLO4, NRC04 | |
| SB04A1T | SB04A1T048 | NT04, AT04 | |
| SB04N1 | SB04N1-036, SB04N1-048 | | B-204 |
| SB04N1T | | | BT204 |
| SB05C1 | SB05C1-038, SB05C1-053 | | (B-05, HOB-5) |
| SB05C1T | SB05C1T053 | | (BT05, HOBT-5) |
| SB05B1 | SB05A1-038, SB05A1-053 | N-05 (HJ-5) | |
| SB05A1T | SB05A1T053 | NT05 | |
| SB05N1 | SB05N1-038, SB05N1-053 | | B-205 |
| SB05N1T | | | BT205 |
| SB06B1 | SB06A1-066 | N-06, NLO6, AS06, NRC06, (HJA5-6) | BB206, B-06 (HOB-6, HOS-6, HO-6, HOH-06K, BB06) |
| SB06A1T | SB06A1T066 | NT06, NLT06, AT06 | (BT06, HOBT-6) |
| SB06C1 | | (HT-6) | UVE160K |
| SB06D1 | | DL06 | |
| SB06L1A | | | BS306, B-206, HOH-206, BL206 |
| SB06L1T | | | BT206 |
| SB08B1 | SB08A1-056, SB08A1-076 | N-08, NLO8, AS08, NRC08, DL08, (HJA6-8) | BB208, BS308, B-208, HOH-208, BL208, B-08 (HOB-8, HOS-8, HO-8, HOH-08K, BB08) |
| SB08B1Q | SB08B1Q-76 | HW-08 | |
| SB08A1T | SB08A1T056, SB08A1T076 | NT08, NLT08, AT08 | BT208, (BT08, HOBT-8) |
| SB10A1 | SB10A1-056, SB10A1-080, SB10A1-116 | NL10, AS10, NRC10 | |
| SB10B1 | | N-10, (HJA6-8-10) | BB210, BS310, B-210, BL210, B-10, (HOB-10, HOS-10, HO-10), HOH-10K, UVE200K, UVE250K |
| SB10A2Q | SB10B2Q080 | HW-10, 12 | |
| SB10A2 | SB10A2-080 | (HJ-10) | |
| SB10A1T | SB10A1T080 | NT10, NLT10, AT10 | BT210, (BT10, HOBT-10) |
| SB10D1 | | DL10 | |
| SB12A1 | SB12A1-090 | N-12, NL12, DL12, (HJA6-8-12) | B-12, (HOB-12, HOS-12), HOH-12K |
| SB12C1 | | | UVE315K, (HO-12) |
| SB12A1T | SB12A1T090 | NT12, NLT12 | (BT12, HOBT-12) |
| SB12N1 | SB12N1-090 | | BB212, B-212, BL212 |
| SB12N1T | | | BT212, BLT212 |
| SB15C1 | SB15C1-110 | | B-15-18, (HOB-15-18, HO-15, HOS-15), HOH-15K |
| SB15A1 | SB15A1-110 | (HJA8-15-18-21, HJA11-15) | |
| SB15A2 | | (HJ-15) | UVE400K |
| SB15A2Q | | HW-15 | |
| SB15C1T | | | (BT15, HOBT-15) |
| SB15N1 | SB15N1-110 | N-15, N-18 | B-215 |
| UVE500AR | | | (UVE500AR) |
| SB18A2 | SB18A2-110 | N-21, N-24, (HJ-18-21, HJA11-18-21) | B-21-24, (HOB-21-24, UVE500K-630K, UVE500AR-630AR, UVE500L, UVE630L, UVE500LB, UVE630LB) |
| SB24A2 | SB24A2-130 | (HJA11-24, HJ-24) | (UVE800K, UVE750AR, UVE800LB) |
| SB06BB | SB06BB-040 | | QB306, (QB206) |
| SB08BB | SB08BB-056 | | QB308, (QB208) |
| SB10BB | SB10BB-060 | | QB310, (QB210) |
| SB12BB | SB12BB-070 | | QB312, (QB212) |
| PW-06 | | PW-06 | |
| PW-08 | | PW-08 | |
| PW-10 | | PW-10 | |
| PW-12 | | PW-12 | |
| PW-15 | | PW-15 | |

**Таблица совместимости
стандартных незакаленных кулачков**

| Патрон | Незакаленные кулачки | Патрон | Незакаленные кулачки |
|--------|----------------------|----------|----------------------|
| N-04 | SB04B1 | BT204 | SB04N1T |
| N-05 | SB05B1 | BT205 | SB05N1T |
| N-06 | SB06B1 | BT206 | SB06L1T |
| N-08 | SB08B1 | BT208 | SB08A1T |
| N-10 | SB10B1 | BT210 | SB10A1T |
| N-12 | SB12A1 | BT212 | SB12N1T |
| N-15 | SB15N1 | | |
| N-18 | SB15N1 | BL206 | SB06L1A |
| N-21 | SB18A2 | BL208 | SB08B1 |
| N-24 | SB18A2 | BL210 | SB10B1 |
| | | BL212 | SB12N1 |
| NT-04 | SB04A1T | | |
| NT-05 | SB05A1T | QB306 | SB06BB |
| NLT-06 | SB06A1T | QB308 | SB08BB |
| NLT-08 | SB08A1T | QB310 | SB10BB |
| NLT-10 | SB10A1T | QB312 | SB12BB |
| NLT-12 | SB12A1T | | |
| | | UVE160K | SB06C1 |
| NL-04 | SB04B1 | UVE200K | SB10B1 |
| NL-06 | SB06B1 | UVE250K | SB10B1 |
| NL-08 | SB08B1 | UVE315K | SB12C1 |
| NL-10 | SB10A1 | UVE400K | SB15A2 |
| NL-12 | SB12A1 | UVE500LB | SB18A2 |
| | | UVE500AR | UVE500AR |
| HJ-10 | SB10A2 | UVE630LB | SB18A2 |
| | | UVE630AR | SB18A2 |
| B-04 | SB04C1 | UVE750AR | SB24A2 |
| B-05 | SB05C1 | UVE800LB | SB24A2 |
| B-06 | SB06B1 | | |
| B-08 | SB08B1 | AS04 | SB04B1 |
| B-10 | SB10B1 | AS06 | SB06B1 |
| B-12 | SB12A1 | AS08 | SB08B1 |
| B-15 | SB15C1 | AS10 | SB10A1 |
| B-18 | SB15C1 | | |
| B-21 | SB18A2 | AT04 | SB04A1T |
| B-24 | SB18A2 | AT06 | SB06A1T |
| | | AT08 | SB08A1T |
| BT-04 | SB04C1T | AT10 | SB10A1T |
| BT-05 | SB05C1T | | |
| BT-06 | SB06A1T | NRC04 | SB04B1 |
| BT-08 | SB08A1T | NRC06 | SB06B1 |
| BT-10 | SB10A1T | NRC08 | SB08B1 |
| BT-12 | SB12A1T | NRC10 | SB10B1 |
| BT-15 | SB15C1T | | |
| | | HW-08 | SB08B1Q |
| B-204 | SB04N1 | HW-10 | SB10A2Q |
| B-205 | SB05N1 | HW-12 | SB10A2Q |
| B-206 | SB06L1A | HW-15 | SB15A2Q |
| B-208 | SB08B1 | | |
| B-210 | SB10B1 | HOH206 | SB06L1A |
| B-212 | SB12N1 | HOH208 | SB08B1 |
| B-215 | SB15N1 | HOH10K | SB10B1 |
| | | HOH12K | SB12A1 |
| BB06 | SB06B1 | HOH15K | SB15C1 |
| BB08 | SB08B1 | | |
| | | DL06 | SB06D1 |
| | | DL08 | SB08B1 |
| | | DL10 | SB10D1 |
| | | DL12 | SB12A1 |

**Таблица совместимости
стандартных незакаленных кулачков**

| Патрон | Незакаленные кулачки | Патрон | Незакаленные кулачки |
|--------|----------------------|--------|----------------------|
| BB206 | SB06B1 | PW-06 | SBPW-06 |
| BB208 | SB08B1 | PW-08 | SBPW-08 |
| BB210 | SB10B1 | PW-10 | SBPW-10 |
| BB212 | SB12N1 | PW-12 | SBPW-12 |
| | | PW-15 | SBPW-15 |
| BS306 | SB06L1A | | |
| BS308 | SB08B1 | UB450K | UB450 |
| BS310 | SB10B1 | UB560K | UB560K |
| | | UB630K | UB710 |
| | | UB710K | UB710 |

**Таблица взаимозаменяемости
стандартных и высоких кулачков**

| Стандартные кулачки | Высокие кулачки |
|---------------------|------------------------------------|
| SB04C1 | SB04C1-036, SB04C1-048 |
| SB04C1T | SB04C1T048 |
| SB04B1 | SB04A1-036, SB04A1-048 |
| SB04A1T | SB04C1T048 |
| SB04N1 | SB04N1-036, SB04N1-048 |
| | |
| SB05C1 | SB05C1-038, SB05C1-053 |
| SB05C1T | SB05C1T053 |
| SB05B1 | SB05A1-038, SB05A1-053 |
| SB05A1T | SB05A1T053 |
| SB05N1 | SB05N1-038, SB05N1-053 |
| | |
| SB06B1 | SB06A1-066 |
| SB06A1T | SB06A1T066 |
| | |
| SB08B1 | SB08A1-056, SB08A1-076 |
| SB08B1Q | SB08B1Q-76 |
| SB08A1T | SB08A1T056, SB08A1T076 |
| | |
| SB10B1 (A1) | SB10A1-056, SB10A1-080, SB10A1-116 |
| SB10A2Q | SB10A2Q080 |
| SB10A2 | SB10A2-080 |
| SB10A1T | SB10A1T080 |
| | |
| SB12A1 | SB12A1-090 |
| SB12A1T | SB12A1T090 |
| SB12N1 | SB12N1-090 |
| | |
| SB15A1 | SB15A1-110 |
| SB15C1 | SB15C1-110 |
| SB15N1 | SB15N1-110 |
| | |
| SB18A2 | SB18A2-110 |
| | |
| SB24A2 | SB24A2-130 |
| | |
| SB06BB | SB06BB-040 |
| SB08BB | SB08BB-056 |
| SB10BB | SB10BB-060 |
| SB12BB | SB12BB-070 |

Эскиз 1

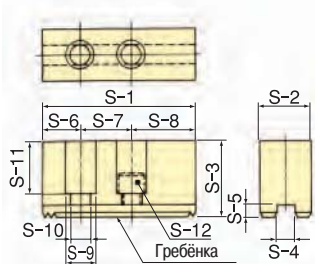

Эскиз 2

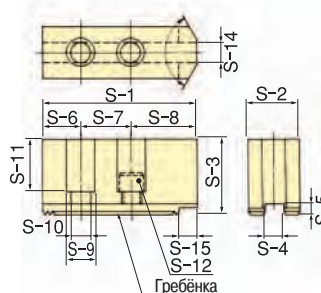

■ Размеры незакаленных кулачков

| Тип кулачков | S-1 | S-2 | S-3 | S-4 | S-5 | S-6 | S-7 | S-8 | S-9 | S-10 | S-11 | S-12 | S-14 | S-15 | Шаг гребёнки | Эскиз |
|--------------|-------|-----|------|------|-----|------|-----|-------|------|------|------|------|------|------|--------------|-------|
| SB04C1 | 48 | 19 | 23 | 8 | 3 | 8 | 15 | 25 | 11 | 6.6 | 15 | M6 | 6 | | 1.5×60° | 2 |
| SB04C1-036 | 48 | 19 | 36 | 8 | 3 | 8 | 15 | 25 | 11 | 6.6 | 28 | M6 | | | 1.5×60° | 1 |
| SB04C1-048 | 48 | 19 | 48 | 8 | 3 | 8 | 15 | 25 | 11 | 6.6 | 40 | M6 | | | 1.5×60° | 1 |
| SB04C1T | 48 | 19 | 23 | 8 | 3 | 8 | 15 | 25 | 11 | 6.6 | 15 | M6 | | | 1.5×60° | 1 |
| SB04C1T048 | 48 | 19 | 48 | 8 | 3 | 8 | 15 | 25 | 11 | 6.6 | 40 | M6 | | | 1.5×60° | 1 |
| SB04B1 | 55 | 23 | 25 | 10 | 4 | 13 | 14 | 28 | 13.5 | 8.5 | 16 | M8 | 3 | 13 | 1.5×60° | 2 |
| SB04A1-036 | 55 | 23 | 36 | 10 | 4 | 13 | 14 | 28 | 13.5 | 8.5 | 27 | M8 | | | 1.5×60° | 1 |
| SB04A1-048 | 55 | 23 | 48 | 10 | 4 | 13 | 14 | 28 | 13.5 | 8.5 | 39 | M8 | | | 1.5×60° | 1 |
| SB04A1T | 55 | 23 | 25 | 10 | 4 | 13 | 14 | 28 | 13.5 | 8.5 | 16 | M8 | | | 1.5×60° | 1 |
| SB04A1T048 | 55 | 23 | 48 | 10 | 4 | 13 | 14 | 28 | 13.5 | 8.5 | 39 | M8 | | | 1.5×60° | 1 |
| SB04N1 | 49.5 | 23 | 23 | 10 | 4 | 10 | 14 | 25.5 | 13.5 | 8.5 | 14.5 | M8 | 4 | | 1.5×60° | 2 |
| SB04N1T | 49.5 | 23 | 23 | 10 | 4 | 10 | 14 | 25.5 | 13.5 | 8.5 | 14.5 | M8 | | | 1.5×60° | 1 |
| SB04N1-036 | 49.5 | 23 | 36 | 10 | 4 | 10 | 14 | 25.5 | 13.5 | 8.5 | 27.5 | M8 | | | 1.5×60° | 1 |
| SB04N1-048 | 49.5 | 23 | 48 | 10 | 4 | 10 | 14 | 25.5 | 13.5 | 8.5 | 39.5 | M8 | | | 1.5×60° | 1 |
| SB05C1 | 57 | 23 | 31 | 10 | 3 | 10 | 18 | 29 | 13.5 | 8.5 | 22 | M8 | 12 | | 1.5×60° | 2 |
| SB05C1-038 | 57 | 23 | 38 | 10 | 3 | 10 | 18 | 29 | 13.5 | 8.5 | 29 | M8 | | | 1.5×60° | 1 |
| SB05C1-053 | 57 | 23 | 53 | 10 | 3 | 10 | 18 | 29 | 13.5 | 8.5 | 44 | M8 | | | 1.5×60° | 1 |
| SB05C1T | 57 | 23 | 31 | 10 | 3 | 10 | 18 | 29 | 13.5 | 8.5 | 22 | M8 | | | 1.5×60° | 1 |
| SB05C1T053 | 57 | 23 | 53 | 10 | 3 | 10 | 18 | 29 | 13.5 | 8.5 | 44 | M8 | | | 1.5×60° | 1 |
| SB05B1 | 62 | 23 | 27 | 10 | 4 | 14 | 19 | 29 | 13.5 | 8.5 | 18 | M8 | 12 | 14 | 1.5×60° | 2 |
| SB05A1-038 | 62 | 23 | 38 | 10 | 4 | 14 | 19 | 29 | 13.5 | 8.5 | 29 | M8 | | | 1.5×60° | 1 |
| SB05A1-053 | 62 | 23 | 53 | 10 | 4 | 14 | 19 | 29 | 13.5 | 8.5 | 44 | M8 | | | 1.5×60° | 1 |
| SB05A1T | 62 | 23 | 27 | 10 | 4 | 14 | 19 | 29 | 13.5 | 8.5 | 18 | M8 | | | 1.5×60° | 1 |
| SB05A1T053 | 62 | 23 | 53 | 10 | 4 | 14 | 19 | 29 | 13.5 | 8.5 | 44 | M8 | | | 1.5×60° | 1 |
| SB05N1 | 54 | 23 | 25 | 10 | 4 | 12 | 14 | 28 | 13.5 | 8.5 | 16.5 | M8 | 5 | | 1.5×60° | 2 |
| SB05N1T | 54 | 23 | 25 | 10 | 4 | 12 | 14 | 28 | 13.5 | 8.5 | 16.5 | M8 | | | 1.5×60° | 1 |
| SB05N1-038 | 54 | 23 | 38 | 10 | 4 | 12 | 14 | 28 | 13.5 | 8.5 | 29.5 | M8 | | | 1.5×60° | 1 |
| SB05N1-053 | 54 | 23 | 53 | 10 | 4 | 12 | 14 | 28 | 13.5 | 8.5 | 44.5 | M8 | | | 1.5×60° | 1 |
| SB06B1 | 72 | 31 | 32 | 12 | 5 | 15 | 20 | 37 | 17 | 11 | 20 | M10 | 12 | 15 | 1.5×60° | 2 |
| SB06A1-066 | 72 | 31 | 66 | 12 | 5 | 15 | 20 | 37 | 17 | 11 | 54 | M10 | | | 1.5×60° | 1 |
| SB06A1T | 72 | 31 | 32 | 12 | 5 | 15 | 20 | 37 | 17 | 11 | 20 | M10 | | | 1.5×60° | 1 |
| SB06A1T066 | 72 | 31 | 66 | 12 | 5 | 15 | 20 | 37 | 17 | 11 | 54 | M10 | | | 1.5×60° | 1 |
| SB06C1 | 76.5 | 40 | 37 | 14 | 5 | 15 | 25 | 36.5 | 19 | 13 | 22 | M12 | | | 1.5×60° | 1 |
| SB06L1A | 66 | 26 | 28 | 12 | 5 | 12 | 20 | 34 | 17 | 11 | 16 | M10 | 5 | 12 | 1.5×60° | 2 |
| SB06L1T | 66 | 26 | 28 | 12 | 5 | 12 | 20 | 34 | 17 | 11 | 16 | M10 | | | 1.5×60° | 1 |
| SB08B1 | 95 | 35 | 38 | 14 | 5 | 24 | 25 | 46 | 19 | 13 | 23 | M12 | 12 | 20 | 1.5×60° | 2 |
| SB08A1-056 | 95 | 35 | 56 | 14 | 5 | 24 | 25 | 46 | 19 | 13 | 41 | M12 | | | 1.5×60° | 1 |
| SB08A1-076 | 95 | 35 | 76 | 14 | 5 | 24 | 25 | 46 | 19 | 13 | 61 | M12 | | | 1.5×60° | 1 |
| SB08B1Q | 90 | 31 | 38 | 12 | 5 | 24 | 20 | 46 | 17 | 11 | 26 | M10 | 16 | 24 | 1.5×60° | 2 |
| SB08B1Q-76 | 90 | 31 | 76 | 12 | 5 | 24 | 20 | 46 | 17 | 11 | 64 | M10 | 16 | 24 | 1.5×60° | 2 |
| SB08A1T | 95 | 35 | 38 | 14 | 5 | 24 | 25 | 46 | 19 | 13 | 23 | M12 | | | 1.5×60° | 1 |
| SB08A1T056 | 95 | 35 | 56 | 14 | 5 | 24 | 25 | 46 | 19 | 13 | 41 | M12 | | | 1.5×60° | 1 |
| SB08A1T076 | 95 | 35 | 76 | 14 | 5 | 24 | 25 | 46 | 19 | 13 | 61 | M12 | | | 1.5×60° | 1 |
| UB450 | 165 | 62 | 66 | 25.5 | 8 | 37 | 43 | 85 | 32 | 21 | 43 | M20 | | | 3.0×60° | 1 |
| UB560K | 180 | 65 | 69.2 | 25.5 | 8 | 39.5 | 60 | 80.5 | 32 | 21 | 45.3 | M20 | | | 3.0×60° | 1 |
| UB710 | 209.5 | 75 | 80 | 30 | 9 | 40 | 60 | 109.5 | 39 | 26 | 55 | M24 | | | 3.0×60° | 1 |

Эскиз 3

Внесение изменений в заштрихованной области недопустимо

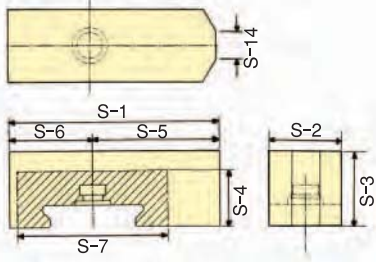

Эскиз 4

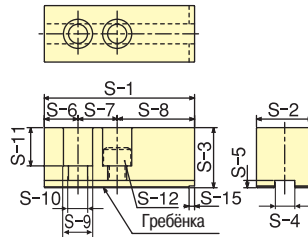

Гребёнка - эскиз 1, 2, 4

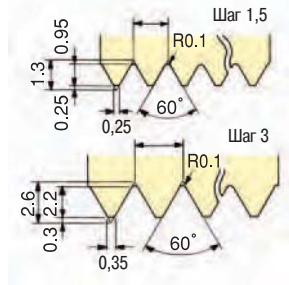

Размеры незакаленных кулачков

| Тип кулачков | S-1 | S-2 | S-3 | S-4 | S-5 | S-6 | S-7 | S-8 | S-9 | S-10 | S-11 | S-12 | S-14 | S-15 | Шаг гребёнки | Фикс |
|--------------|-------|------|-------|-------|-----|------|-------|-------|-----|------|------|------|------|------|--------------|------|
| SB10B1 | 110 | 40 | 42 | 16 | 5 | 30 | 30 | 50 | 19 | 13 | 27 | M12 | 15 | 20 | 1.5×60° | 2 |
| SB10A1 | 110 | 40 | 42 | 16 | 5 | 30 | 30 | 50 | 19 | 13 | 27 | M12 | | | 1.5×60° | 1 |
| SB10A1-056 | 110 | 40 | 56 | 16 | 5 | 30 | 30 | 50 | 19 | 13 | 41 | M12 | | | 1.5×60° | 1 |
| SB10A1-080 | 110 | 40 | 80 | 16 | 5 | 30 | 30 | 50 | 19 | 13 | 65 | M12 | | | 1.5×60° | 1 |
| SB10A1-116 | 110 | 40 | 116 | 16 | 5 | 30 | 30 | 50 | 19 | 13 | 101 | M12 | | | 1.5×60° | 1 |
| SB10A2Q | 110 | 40 | 42 | 16 | 6 | 30 | 30 | 50 | 19 | 13 | 26 | M12 | | | 3.0×60° | 1 |
| SB10A2Q080 | 110 | 40 | 80 | 16 | 6 | 30 | 30 | 50 | 19 | 13 | 64 | M12 | | | 3.0×60° | 1 |
| SB10A2 | 110 | 40 | 42 | 16 | 6 | 30 | 30 | 50 | 19 | 13 | 26 | M12 | | | 3.0×60° | 1 |
| SB10A2-080 | 110 | 40 | 80 | 16 | 6 | 30 | 30 | 50 | 19 | 13 | 65 | M12 | | | 3.0×60° | 1 |
| SB10A1T | 110 | 40 | 42 | 16 | 5 | 30 | 30 | 50 | 19 | 13 | 27 | M12 | | | 1.5×60° | 1 |
| SB10A1T080 | 110 | 40 | 80 | 16 | 5 | 30 | 30 | 50 | 19 | 13 | 65 | M12 | | | 1.5×60° | 1 |
| SB12A1 | 129 | 50 | 50 | 18 | 5 | 39 | 30 | 60 | 23 | 15 | 30 | M14 | | | 1.5×60° | 1 |
| SB12A1-090 | 129 | 50 | 90 | 18 | 5 | 39 | 30 | 60 | 23 | 15 | 70 | M14 | | | 1.5×60° | 1 |
| SB12C1 | 129 | 50 | 50 | 18 | 5 | 32 | 38 | 59 | 22 | 15 | 35 | M14 | | | 1.5×60° | 1 |
| SB12A1T | 129 | 50 | 50 | 18 | 5 | 39 | 30 | 60 | 23 | 15 | 30 | M14 | | | 1.5×60° | 1 |
| SB12A1T090 | 129 | 50 | 90 | 18 | 5 | 39 | 30 | 60 | 23 | 15 | 70 | M14 | | | 1.5×60° | 1 |
| SB12N1 | 111 | 50 | 50 | 21 | 4 | 21 | 30 | 60 | 25 | 17 | 33 | M16 | | | 1.5×60° | 1 |
| SB12N1-090 | 111 | 50 | 90 | 21 | 4 | 21 | 30 | 60 | 25 | 17 | 73 | M16 | | | 1.5×60° | 1 |
| SB12N1T | 111 | 50 | 50 | 21 | 4 | 21 | 30 | 60 | 25 | 17 | 33 | M16 | | | 1.5×60° | 1 |
| SB15C1 | 165 | 62 | 66 | 22 | 8 | 37 | 43 | 85 | 32 | 21 | 42 | M20 | 6 | | 1.5×60° | 4 |
| SB15C1-110 | 165 | 62 | 110 | 22 | 8 | 37 | 43 | 85 | 32 | 21 | 86 | M20 | 6 | | 1.5×60° | 4 |
| SB15A1 | 156 | 62 | 70 | 22 | 8 | 36 | 60 | 60 | 32 | 21 | 45 | M20 | | | 1.5×60° | 1 |
| SB15A1-110 | 156 | 62 | 110 | 22 | 8 | 36 | 60 | 60 | 32 | 21 | 85 | M20 | | | 1.5×60° | 1 |
| SB15A2 | 156 | 62 | 70 | 22 | 9 | 36 | 60 | 60 | 32 | 21 | 45 | M20 | | | 3.0×60° | 1 |
| SB15A2Q | 129 | 50 | 50 | 18 | 6 | 32 | 38 | 59 | 22 | 15 | 34 | M14 | | | 3.0×60° | 1 |
| SB15C1T | 165 | 62 | 66 | 22 | 8 | 37 | 43 | 85 | 32 | 21 | 42 | M20 | 6 | | 1.5×60° | 4 |
| SB15N1 | 135 | 50 | 60 | 25.5 | 5 | 26 | 43 | 66 | 32 | 21 | 39 | M20 | | | 1.5×60° | 1 |
| SB15N1-110 | 135 | 50 | 110 | 25.5 | 5 | 26 | 43 | 66 | 32 | 21 | 89 | M20 | | | 1.5×60° | 1 |
| UVE500AR | 210 | 65 | 100 | 25 | 9 | 40 | 60 | 110 | 32 | 21 | 75 | M20 | | | 3.0×60° | 1 |
| SB18A2 | 180 | 65 | 70 | 25 | 9 | 40 | 60 | 80 | 32 | 21 | 45 | M20 | | | 3.0×60° | 1 |
| SB18A2-110 | 180 | 65 | 110 | 25 | 9 | 40 | 60 | 80 | 32 | 21 | 85 | M20 | | | 3.0×60° | 1 |
| SB24A2 | 210 | 75 | 90 | 25 | 9 | 40 | 80 | 90 | 32 | 21 | 65 | M20 | | | 3.0×60° | 1 |
| SB24A2-130 | 210 | 75 | 130 | 25 | 9 | 40 | 80 | 90 | 32 | 21 | 105 | M20 | | | 3.0×60° | 1 |
| SB06BB | 90 | 32 | 30 | 24 | 54 | 36 | 68 | | | | | | 5 | | | 3 |
| SB06BB-040 | 90 | 32 | 40 | 24 | 54 | 36 | 68 | | | | | | 5 | | | 3 |
| SB08BB | 106 | 37 | 38 | 28 | 64 | 42 | 76 | | | | | | 14 | | | 3 |
| SB08BB-056 | 106 | 37 | 56 | 28 | 64 | 42 | 76 | | | | | | 14 | | | 3 |
| SB10BB | 125 | 42 | 42 | 31 | 76 | 49 | 88 | | | | | | 26 | | | 3 |
| SB10BB-060 | 125 | 42 | 60 | 31 | 76 | 49 | 88 | | | | | | 26 | | | 3 |
| SB12BB | 139 | 42 | 50 | 34 | 90 | 49 | 92 | | | | | | 30 | | | 3 |
| SB12BB-070 | 139 | 42 | 70 | 34 | 90 | 49 | 92 | | | | | | 30 | | | 3 |
| PW-06 | 67.5 | 50.8 | 51 | 38.07 | 3.3 | 15 | 29.36 | 23.14 | 17 | 11 | 42.4 | M10 | 8 | | | 2 |
| PW-08 | 74 | 57 | 57.47 | 44.45 | 3.3 | 15 | 34.14 | 24.86 | 20 | 13.5 | 47 | M12 | | | | 1 |
| PW-10 | 89.5 | 70.1 | 70.2 | 57.1 | 3.3 | 19 | 44.45 | 26.05 | 25 | 17 | 59 | M16 | | | | 1 |
| PW-12 | 108.5 | 70.1 | 70.2 | 57.1 | 3.3 | 19 | 44.45 | 45.05 | 25 | 17 | 59 | M16 | | | | 1 |
| PW-15 | 140 | 76.2 | 76.5 | 66.62 | 3.3 | 23.9 | 53.98 | 62.12 | 32 | 21 | 61.2 | M20 | | | | 1 |
| SB06D1 | 72 | 31 | 32 | 12 | 5 | 22 | 20 | 30 | 17 | 11 | 20 | M10 | 6 | 15 | 1.5×60° | 2 |
| SB10D1 | 101.5 | 45 | 45 | 18 | 5 | 22.5 | 30 | 49 | 22 | 15 | 25 | M14 | 15 | 17.5 | 1.5×60° | 2 |



КУЛАЧКИ

ЗАКАЛЕННЫЕ КУЛАЧКИ ДЛЯ МЕХАНИЗИРОВАННЫХ ПАТРОНОВ

серия **НВ**

НВ06В1

Шаг гребёнки: 1 = 1,5мм x 60°; 2 = 3мм x 60°.
 Форма и характеристика кулачка:
 А = 3-х ступенчатый кулачек; В = 2-х ступенчатый кулачек;
 С = расстояние между болтами (в случае если расстояние между болтами различается при одинаковом диаметре патрона)
 U = для патрона UVE; N = новый тип
 Размер патрона
 Закаленные кулачки

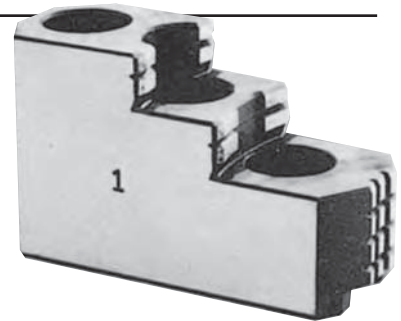

Комбинации закаленных кулачков (модели патронов в скобках сняты с производства)

| Тип кулачков | Патроны без сквозного отверстия | Патроны со сквозным отверстием |
|--------------|---|---|
| НВ04В1 | | (В-04) |
| НВ04Н1 | N-04 | В-204, В-205 |
| НВ05В1 | | (В-05) |
| НВ05С1 | N-05 | |
| НВ06А1 | N-06, NL06, (HJ-6, HJA5-6) | ВВ206, BS306, В-206, НОН-206, BL206, (ВВ06) |
| НВ06В1 | N-06, NL06, (HJ-6, HJA5-6) | ВВ206, BS306, В-206, НОН-206, BL206, (ВВ06) В-06, (НОВ-6, НОС-6, НО-6) |
| НВ08А1 | | В-208, НОН-208, BL208, В-08, (НОВ-8, НОС-8, НО-8) |
| НВ08В1 | N-08, NL08, (HJ-8, HJA6-8) | ВВ208, BS308 |
| НВ08Н1 | | (ВВ08) |
| НВ10А1 | N-10, NL10, (HJ-10, HJA6-8-10) | В-210, НОН-10К, BL210, В-10, (НОВ-10, НОС-10, НО-10) |
| НВ10АА1 | | ВВ210, BS310 |
| НВ12В1 | N-12, NL12, (HJA6-8-12, HLA6-12, HLA6-8-15) | НОН-12К, В-12, (НОВ-12, НОС-12, НО-12) |
| НВ12С1 | | (НО-12) |
| НВ12Н1 | | ВВ212, В-212, BL212 |
| НВ15А1 | | НОН-15К, В-15, (НОВ-15, НОС-15, НО-15), В-18, (НОВ-18) |
| НВ15В1 | (HJA8-15-18-21, HJA11-15, HLA-18-21) | |
| НВ15Н1 | N-15, N-18 | В-215 |
| НВ18В2 | N-21, N-24 (HJA11-18-21, HJA15-21) | В-21 (НОВ-21), В-24 (НОВ-24) (UVE500, UVE630) |
| НВ24В2 | (HJA11-15-24) | (UVE800) |
| НВ06U1 | | UVE160K |
| НВ08U1 | | UVE200K, UVE250K |
| НВ12U1 | | UVE315K |
| НВ16U2 | | UVE400K |
| НВ18W2 | | UB450K |

Эскиз 1

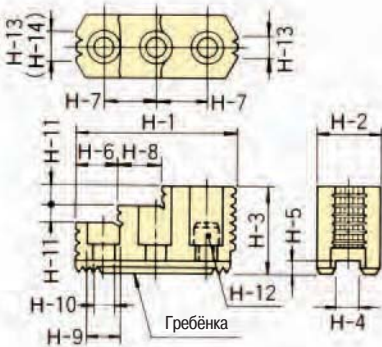

Эскиз 2

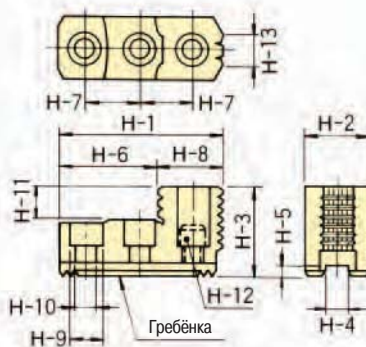

Эскиз 3

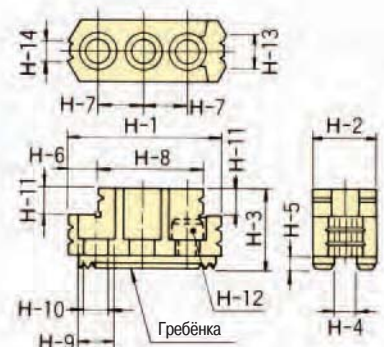

Размеры закаленных кулачков

| Тип кулачков | H-1 | H-2 | H-3 | H-4 | H-5 | H-6 | H-7 | H-8 | H-9 | H-10 | H-11 | H-12 | H-13 | H-14 | Шаг гребёнки | Эскиз |
|--------------|--------|-----|------|------|-----|-------|-----|------|------|------|------|------|------|------|--------------|-------|
| НВ04В1 | 46 | 19 | 23 | 8 | 3 | 15 | 15 | 23,5 | 11 | 6,6 | 9 | M 6 | 6 | - | 1,5 | 3 |
| НВ04Н1 | 53 | 23 | 27,5 | 10 | 4 | 30,5 | 14 | 22,5 | 13,5 | 8,5 | 10 | M 8 | 6 | - | 1,5 | 2 |
| НВ05В1 | 55,5 | 23 | 31 | 10 | 3 | 22,5 | 18 | 21,5 | 13,5 | 8,5 | 14 | M 8 | 6 | - | 1,5 | 3 |
| НВ05С1 | 61 | 23 | 30 | 10 | 4 | 7,5 | 19 | 53,5 | 13,5 | 8,5 | 12 | M 8 | 6 | - | 1,5 | 2 |
| НВ06А1 | 66,6 | 31 | 36 | 12 | 5 | 40 | 20 | 26,6 | 17 | 11 | 12 | M10 | 10 | - | 1,5 | 2 |
| НВ06В1 | 67,5 | 31 | 35 | 12 | 5 | 13 | 20 | 46 | 17 | 11 | 12 | M10 | 16 | 10 | 1,5 | 3 |
| НВ08А1 | 86 | 35 | 51 | 14 | 5 | 31 | 25 | 18 | 19 | 13 | 12 | M12 | 12 | 12 | 1,5 | 1 |
| НВ08В1 | 92 | 35 | 51 | 14 | 5 | 7 | 25 | 68 | 19 | 13 | 18 | M12 | 11 | 11 | 1,5 | 3 |
| НВ08Н1 | | | | | | | | | | | | | | | | |
| НВ10А1 | 99,5 | 40 | 54 | 16 | 5 | 43 | 30 | 17 | 19 | 13 | 13 | M12 | 15 | 15 | 1,5 | 1 |
| НВ10АА1 | 102,5 | 40 | 54 | 16 | 5 | 43 | 30 | 17 | 19 | 13 | 13 | M12 | 15 | 15 | 1,5 | 1 |
| НВ12В1 | 97,5 | 50 | 55 | 18 | 5 | 64,5 | 30 | 33 | 23 | 15 | 20 | M14 | 30 | - | 1,5 | 2 |
| НВ12С1 | 113 | 50 | 50 | 18 | 5 | 69,5 | 38 | 43,5 | 22 | 15 | 20 | M14 | 18 | - | 1,5 | 2 |
| НВ12Н1 | 103 | 50 | 52 | 21 | 4 | 62,5 | 30 | 40,5 | 25 | 17 | 17 | M16 | 30 | - | 1,5 | 2 |
| НВ15А1 | 149 | 62 | 86 | 22 | 8 | 63 | 43 | 34 | 32 | 21 | 20 | M20 | 40 | 40 | 1,5 | 1 |
| НВ15В1 | 141,75 | 70 | 77,5 | 22 | 8 | 87,75 | 43 | 54 | 32 | 21 | 30 | M20 | 50 | - | 1,5 | 2 |
| НВ15Н1 | 149 | 62 | 86 | 25,5 | 5 | 69 | 43 | 27 | 32 | 21 | 20 | M20 | 43 | 38 | 1,5 | 1 |
| НВ18В2 | 159,5 | 80 | 90 | 25 | 9 | 104,5 | 50 | 55 | 32 | 21 | 40 | M20 | 55 | - | 3,0 | 2 |
| НВ24В2 | 183,5 | 90 | 105 | 25 | 9 | 116,5 | 60 | 67 | 32 | 21 | 50 | M20 | 76 | - | 3,0 | 2 |
| НВ06U1 | 69,5 | 35 | 48 | 14 | 5 | 34 | 19 | 18 | 19 | 13 | 12 | M12 | 12 | 20 | 1,5 | 1 |
| НВ08U1 | 79,25 | 40 | 42 | 16 | 5 | 35,25 | 21 | 44 | 19 | 13 | 14 | M12 | 12 | - | 1,5 | 2 |
| НВ12U1 | 107,25 | 45 | 50 | 18 | 5 | 56,75 | 30 | 50,5 | 22 | 15 | 20 | M14 | 25 | - | 1,5 | 2 |
| НВ16U2 | 138,5 | 60 | 71 | 22 | 9 | 76,5 | 43 | 62 | 32 | 21 | 26 | M20 | 35 | - | 3,0 | 2 |
| НВ18W2 | 155,5 | 60 | 85 | 25,5 | 9 | 79,5 | 43 | 24 | 32 | 21 | 20 | M20 | 38 | - | 3,0 | 1 |



ПАЗОВЫЕ СУХАРИ

Эскиз 1

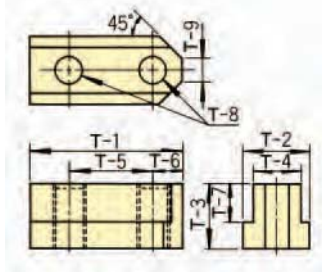

※T-8 Размер крепежного болта
незакаленных кулачков

Эскиз 2

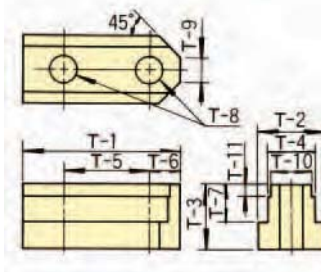

※T-8 Размер крепежного болта
незакаленных кулачков



Эскиз 3

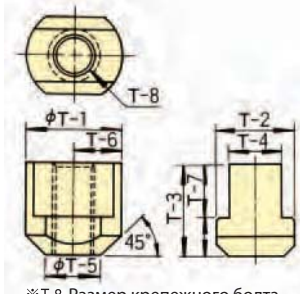

※T-8 Размер крепежного болта
незакаленных кулачков

Эскиз 4

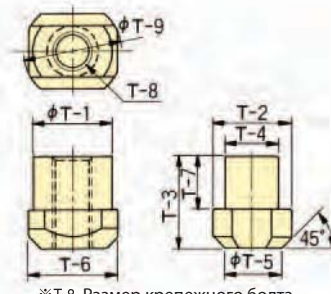

※T-8 Размер крепежного болта
незакаленных кулачков

Эскиз 5

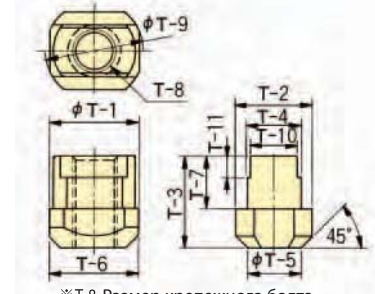

※T-8 Размер крепежного болта
незакаленных кулачков

※ При размещении заказа, пожалуйста, укажите тип патрона и размеры пазового сухаря.

Комбинации и размеры пазовых сухарей ※ Модели патронов в скобках сняты с производства.

| T-1 | T-2 | T-3 | T-4 | T-5 | T-6 | T-7 | T-8 | T-9 | T-10 | T-11 | Подходящий патрон | Эскиз |
|-------|------|-------|-------|-------|------|-------|-----|------|------|------|--|-------|
| 24,5 | 11,5 | 13,5 | 8 | 15 | 4,5 | 9 | M6 | 5 | — | — | (B-04, BT04) | 1 |
| 26 | 14,5 | 15 | 10 | 14 | 6 | 9,5 | M8 | 5 | — | — | B-204, BT204, B-205, BT205 | 1 |
| 28 | 15 | 18 | 10 | 14 | 7 | 12,5 | M8 | 5 | — | — | (N-04, NT04, NL04, AS04, AT04, NRC04, (HJ-4) | 1 |
| 30 | 14 | 15,5 | 10 | 18 | 6 | 10 | M8 | 5 | — | — | (B-05, BT05, HOB-5, HOBТ-5) | 1 |
| 32 | 15 | 18 | 10 | 19 | 6 | 12,5 | M8 | 6 | — | — | (N-05, NT05, (HJ-5) | 1 |
| 36,5 | 17 | 18,5 | 12 | 20 | 8,25 | 11 | M10 | 8 | — | — | BB206 | 1 |
| 36 | 17,5 | 18,5 | 12 | 20 | 8,25 | 11 | M10 | 8 | — | — | HW-08 | 1 |
| 36,5 | 17,5 | 22,5 | 12 | 20 | 7,5 | 15 | M10 | 6 | — | — | (N-06, (NT06, HJ-6), NL06, NLT06, AS06, AT06, NRC06 | 1 |
| 46,5 | 20,5 | 20,5 | 14 | 25 | 10,5 | 12 | M12 | 12 | — | — | BB208, BS308, B-208, BT208, HOB-208, BL208, BLT208 | 1 |
| 48 | 20,5 | 25,5 | 14 | 25 | 11 | 16 | M12 | 8 | — | — | (N-08, (NT08, HJ-8), NL08, NLT08, AS08, AT08, NRC08 | 1 |
| 51 | 22,5 | 21,5 | 16 | 30 | 11 | 13 | M12 | 11 | — | — | BB210, BS310, B-210, BT210, BL210, BLT210 | 1 |
| 55 | 22,5 | 25,5 | 16 | 30 | 11 | 16 | M12 | 8 | — | — | (N-10, (NT10, HJ-10), NL10, NLT10, AS10, AT10, NRC10, HW-10, HW-12 | 1 |
| 56,25 | 29,5 | 22,75 | 21 | 30 | 12 | 11,25 | M16 | 9,5 | — | — | BB212 | 1 |
| 55,5 | 29,5 | 27,75 | 21 | 30 | 12 | 16,25 | M16 | 13 | — | — | B-212, BT212, BL212, BLT212 | 1 |
| 55,5 | 26,5 | 31 | 18 | 30 | 11,5 | 17,5 | M14 | 12 | — | — | HOB-12K | 1 |
| 55,5 | 26,5 | 33,5 | 18 | 30 | 11,5 | 20 | M14 | 12 | — | — | (N-12, (NT12), NL12, NLT12 | 1 |
| 62,5 | 26,5 | 33,5 | 18 | 38 | 12 | 20 | M14 | 12 | — | — | HW-15, (HJ-12) | 1 |
| 90 | 37,5 | 45 | 25 | 50 | 20 | 26 | M20 | 16 | — | — | B-21·24, (HOB-21·24) для закаленных кулачков | 1 |
| 100 | 37,5 | 45 | 25 | 60 | 20 | 26 | M20 | 16 | — | — | B-21·24, (HOB-21·24) для незакален. кулачков | 1 |
| 100 | 37,5 | 54 | 25 | 60 | 20 | 35 | M20 | 16 | — | — | (HJ-18, HJ-21) | 1 |
| 100 | 40 | 54 | 25 | 60 | 20 | 35 | M20 | 16 | — | — | (HJA11-24 для закаленных кулачков) | 1 |
| 120 | 40 | 54 | 25 | 80 | 20 | 35 | M20 | 16 | — | — | (HJ-24, HJA11·15-24) | 1 |
| 80 | 33,5 | 40,5 | 24 | 43 | 17 | 24 | M20 | 11 | 22 | 7,5 | HOB-15K | 2 |
| 80 | 33,5 | 45,5 | 24 | 43 | 17 | 29 | M20 | 11 | 22 | 7,5 | (HLA8-18, HJA11-15) | 2 |
| 97 | 33,5 | 45,5 | 24 | 60 | 17 | 29 | M20 | 11 | 22 | 8,5 | (HJ-15, HJA8·11-15, HLA8-18-21) | 2 |
| 80 | 35 | 39,25 | 25,5 | 43 | 17 | 20,25 | M20 | 14 | — | — | B-215 | 1 |
| 42 | 35 | 39,25 | 25,5 | 25 | — | 20,25 | M20 | — | — | — | N-15, N-18 | 3 |
| 46 | 37,5 | 45 | 25 | 26,5 | — | 26 | M20 | — | — | — | N-21, N-24 | 3 |
| 19 | 22,5 | 23,5 | 14 | 19,5 | 19 | 15 | M12 | 24,5 | — | — | UVE160 | 4 |
| 19 | 22,5 | 24 | 16 | 19,5 | 19 | 15,5 | M12 | 24,5 | — | — | UVE200, UVE250 | 4 |
| 24 | 28,5 | 27,5 | 18 | 24 | 24 | 17 | M14 | 32 | — | — | UVE315 | 4 |
| 32 | 36 | 30,5 | 24 | 30 | 32 | 20 | M20 | 40 | 22 | 8,5 | UVE400 | 5 |
| 100 | 36 | 31,5 | 25 | 60 | 20 | 21 | M20 | 16 | — | — | (UVE500LB, UVE630LB) | 1 |
| 120 | 36 | 31,5 | 25 | 80 | 20 | 21 | M20 | 16 | — | — | (UVE800LB) | 1 |
| 32 | 36 | 31,5 | 25 | 30 | 32 | 21 | M20 | 40 | — | — | (UVE500AR) | 4 |
| 32 | 37,5 | 45,5 | 25 | 30 | 34 | 26 | M20 | 42 | — | — | (UVE550AR, UVE630AR, UVE750AR) | 4 |
| 46 | 19,8 | 10,7 | 12,65 | 29,36 | 8,5 | 6 | M10 | — | — | — | PW-06 | 1 |
| 53,2 | 21,6 | 12,9 | 14,24 | 34,14 | 9,5 | 7,4 | M12 | — | — | — | PW-08 | 1 |
| 68,45 | 27,4 | 17 | 19 | 44,45 | 12 | 10 | M16 | — | — | — | PW-10, PW-12 | 1 |
| 32 | 36 | 29,5 | 25,5 | 32 | 32 | 19 | M20 | 42 | — | — | UB450K, UB560K | 4 |
| — | 44 | 44 | 30 | 32 | 36 | 26 | M24 | 52 | — | — | UB630K, UB710K | 4 |



КУЛАЧКИ

ЗАКАЛЕННЫЕ КУЛАЧКИ ДЛЯ СПИРАЛЬНЫХ ПАТРОНОВ

серия **HBS**

HBS06C

Тип патрона
C = JN
Размер патрона
Закаленные кулачки спиральных патронов



■ Таблица совместимости закаленных кулачков

| Тип закаленных кулачков | Подходящий патрон |
|-------------------------|-------------------------|
| HBS06C | JN06T, JN06RA5 |
| HBS07C | JN07T, JN07RA5, JN08RA6 |
| HBS09C | JN09T, JN09RA6 |
| HBS10C | JN10T, JN10RA6 (8) |
| HBS12C | JN12T, JN12RA6 (8) |

■ Размеры

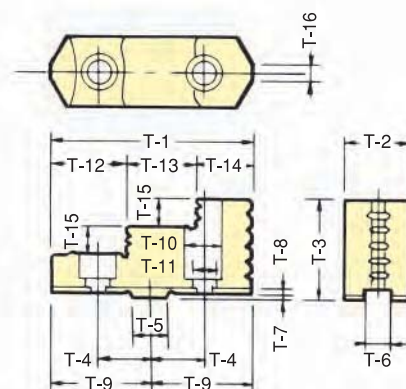
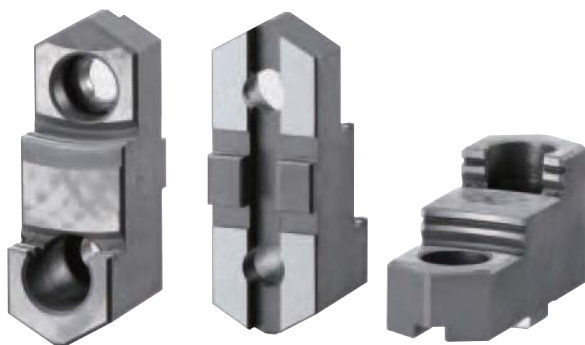

■ Размеры закаленных кулачков

| Тип закаленных кулачков | Размер патрона | T-1 | T-2 | T-3 | T-4 | T-5 | T-6 | T-7 | T-8 | T-9 | T-10 | T-11 | T-12 | T-13 | T-14 | T-15 | T-16 | Болт крепления |
|-------------------------|----------------|-----|-----|-----|------------------------|-------------------------------|-------------------------|-----|-----|------|------|------|------|------|------|------|------|----------------|
| HBS06C | 6 | 68 | 26 | 37 | 19.05 ^{+0.1} | 12.68 ^{+0.008/0.003} | 7.94 ^{+0.05/0} | 3 | 3.5 | 34 | 14 | 8.5 | 26 | 21.5 | 20.5 | 8.5 | 2 | M 8 × 20 |
| HBS07C | 7 | 80 | 28 | 40 | 22.225 ^{+0.1} | 12.68 ^{+0.008/0.003} | 7.94 ^{+0.05/0} | 3 | 3.5 | 40 | 17 | 11 | 30.5 | 26 | 23.5 | 9.5 | 2 | M10 × 20 |
| HBS09C | 9 | 90 | 32 | 48 | 26.99 ^{+0.1} | 19.03 ^{+0.009/0.004} | 12.7 ^{+0.05/0} | 3 | 3.5 | 45 | 19 | 13 | 34 | 30 | 26 | 12 | 3 | M12 × 25 |
| HBS10C | 10 | 100 | 35 | 52 | 26.99 ^{+0.1} | 19.03 ^{+0.009/0.004} | 12.7 ^{+0.05/0} | 3 | 3.5 | 50 | 19 | 13 | 38 | 32 | 30 | 14 | 3 | M12 × 25 |
| HBS12C | 12 | 115 | 40 | 54 | 31.75 ^{+0.1} | 19.03 ^{+0.009/0.004} | 12.7 ^{+0.05/0} | 3 | 3.5 | 57.5 | 19 | 13 | 46 | 35 | 34 | 15 | 4 | M12 × 25 |



КУЛАЧКИ

НЕЗАКАЛЕННЫЕ КУЛАЧКИ ДЛЯ СПИРАЛЬНЫХ ПАТРОНОВ

серия **SBS**



SBS06

Размер патрона
Незакаленные кулачки спиральных патронов

Таблица совместимости незакаленных кулачков

| Тип незакаленных кулачков | Подходящий тип патрона | Прежний тип патрона |
|---------------------------|-------------------------------|-----------------------------------|
| SBS03 | SC-3F | |
| SBS04 | SC-4F | |
| SBS05 | SC-5F | SK-6, KA5-165, KA5C-6 |
| SBS06 | JN06T, JN06RA5 | SK-7, KA6-190, KA6C-200, KA6C-8 |
| SBS07 | JN07T, JN07RA5, JN08RA6, JT07 | SK-9, KA6-230 |
| SBS09 | JN09T, JN09RA6, JT09 | SK-10, KA6 (8) -270, KA6 (8) C-10 |
| SBS10 | JN10T, JN10RA6 (8) | SK-12, KA6 (8) -310, KA6 (8) C-12 |
| SBS12 | JN12T, JN12RA6 (8) | |



Размеры

SBS03, SBS04, SBS05

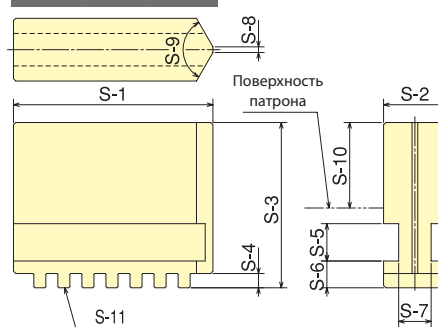

SBS06, SBS07, SBS09, SBS10, SBS12

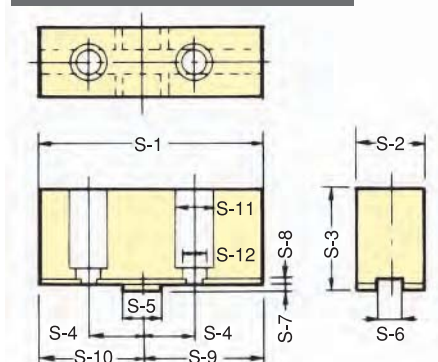

Размеры незакаленных кулачков

| Тип незакаленных кулачков | Размер патрона | S-1 | S-2 | S-3 | S-4 | S-5 | S-6 | S-7 | S-8 | S-9 | S-10 | S-11 | S-12 | Болт крепления |
|---------------------------|----------------|-----|-----|------|------------------------|------------------------------------|-----------------------------|-----|-----|------|------|------|------|----------------|
| SBS03 | 3 | 35 | 11 | 29 | 2.5 | 6.55 | 4.7 | 5.7 | 1 | 120° | 15 | 7 | | |
| SBS04 | 4 | 42 | 14 | 34.5 | 3.5 | 6.55 | 6.2 | 7.2 | 1.5 | 120° | 18 | 7 | | |
| SBS05 | 5 | 50 | 16 | 40 | 4 | 8.2 | 7.7 | 7.2 | 1.5 | 120° | 20 | 7 | | |
| SBS06 | 6 | 75 | 26 | 38 | 19.05 ^{±0.1} | 12.68 ^{+0.008 -0.003} | 7.94 ^{+0.05 0} | 3 | 3.5 | 41 | 34 | 14 | 8.5 | M 8 × 20 |
| SBS07 | 7 | 88 | 28 | 41 | 22.225 ^{±0.1} | 12.68 ^{+0.008 -0.003} | 7.94 ^{+0.05 0} | 3 | 3.5 | 48 | 40 | 17 | 11 | M10 × 20 |
| SBS09 | 9 | 100 | 32 | 48 | 26.99 ^{±0.1} | 19.03 ^{+0.009 -0.004} | 12.7 ^{+0.05 0} | 3 | 3.5 | 55 | 45 | 19 | 13 | M12 × 25 |
| SBS10 | 10 | 110 | 35 | 52 | 26.99 ^{±0.1} | 19.03 ^{+0.009 -0.004} | 12.7 ^{+0.05 0} | 3 | 3.5 | 60 | 50 | 19 | 13 | M12 × 25 |
| SBS12 | 12 | 125 | 40 | 54 | 31.75 ^{±0.1} | 19.03 ^{+0.009 -0.004} | 12.7 ^{+0.05 0} | 3 | 3.5 | 67.5 | 57.5 | 19 | 13 | M12 × 25 |