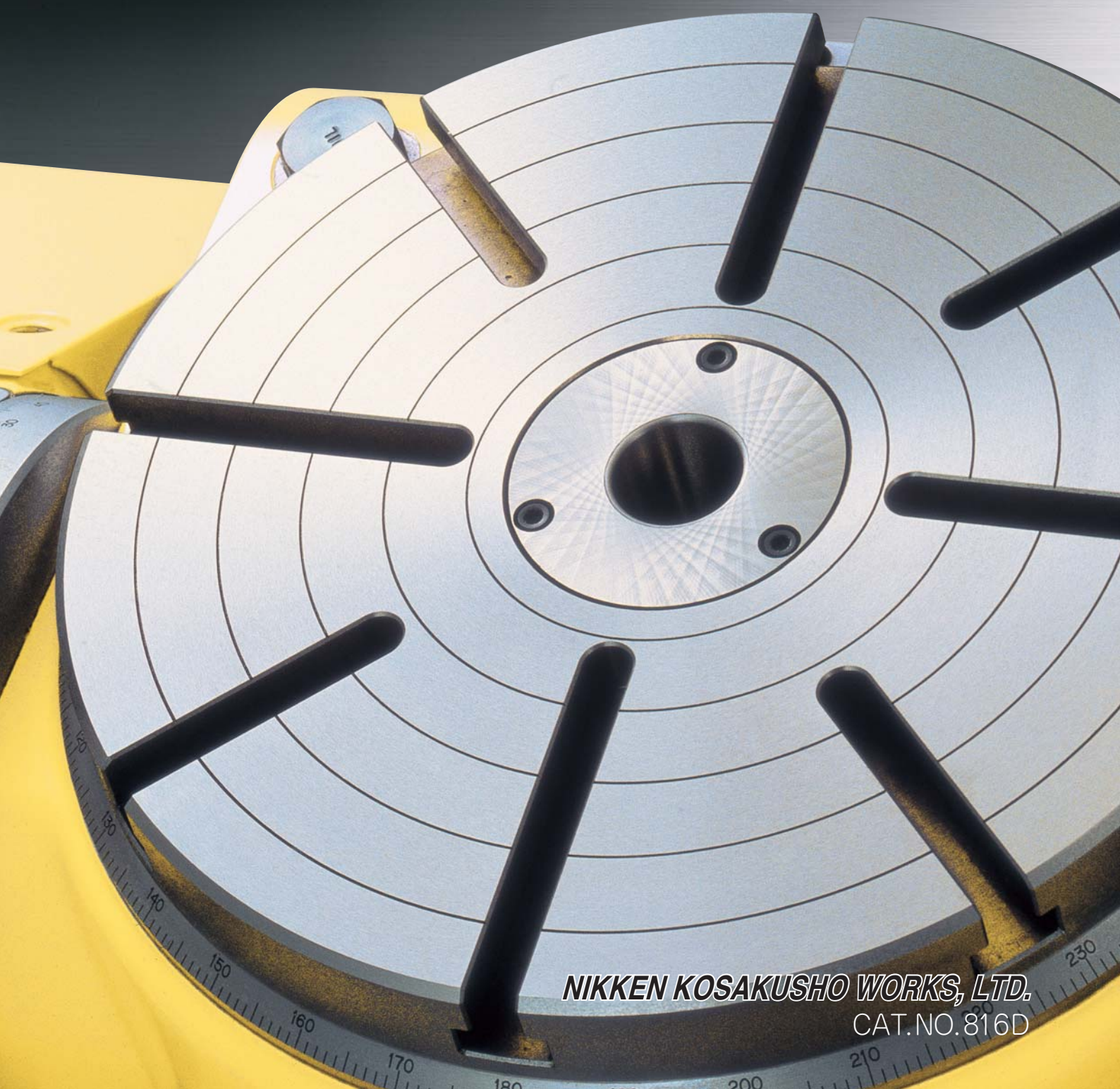


**NIKKEN**

# CNC ROTARY TABLE SERIES



*NIKKEN KOSAKUSHO WORKS, LTD.*  
CAT. NO. 816D

# NIKKEN CNC ROTARY TABLE

## CNC ROTARY TABLE for Full Automation

*Worldwide Field-proven NIKKEN CNC Rotary Table.  
Consequently and finally, NIKKEN Carbide Worm Screw System.*

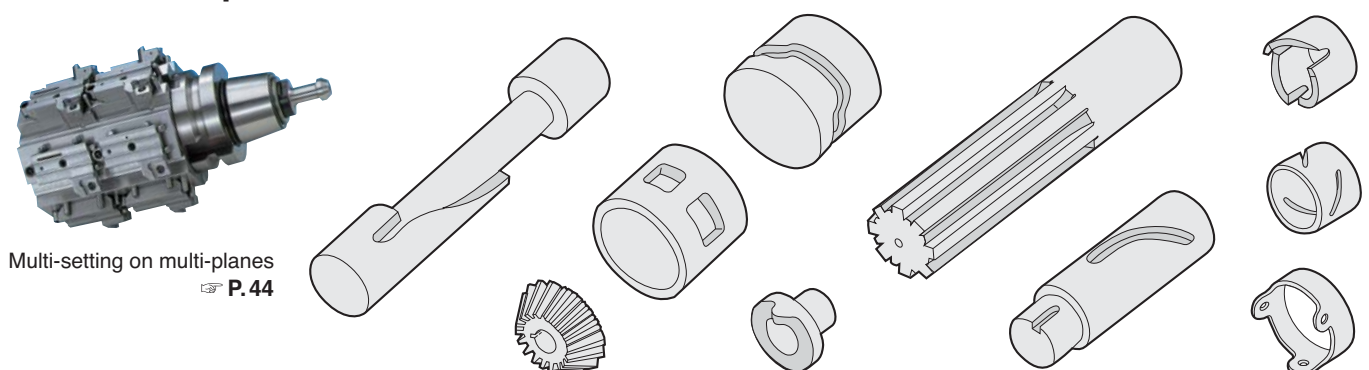
Ion Nitrided  
Worm Wheel  
HV980

Steel Way  
HRC58~60

Carbide Worm Screw

Photo shows the worm system of CNC401.

**Work Sample** Please see for more work samples. [P.37](#) and [P.46](#)



Multi-setting on multi-planes  
[P.44](#)

# NIKKEN CARBIDE WORM SYSTEM

## Anti-Wearing, High Rigidity and High Speed Rotation

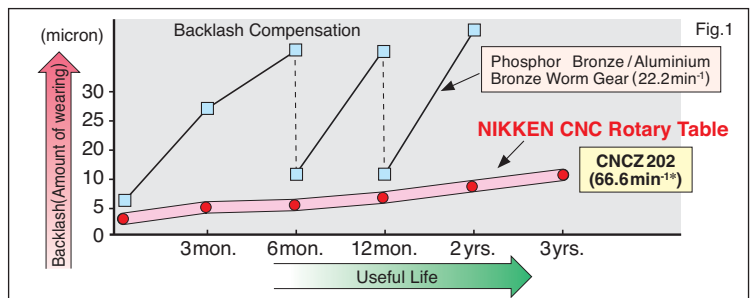
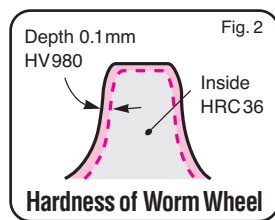
### Carbide Worm Screw

Carbide Worm Screw, hard and strong against high speed rotation, is used. (Photo at right hand side)[Material : V grade Carbide: High anti-wearing and tough quality] Ultra heavy duty, maintaining the high accuracy semi-permanently. Comparing with the traditional combination of worm system (phosphor bronze, aluminium bronze worm wheel and steel worm screw), wearing is largely reduced and table is usable for much more years, resulting in great cost-down. For better impact capability, the special alloy steel worm screw is used for the worm system of the small tooth module.



### Worm Wheel

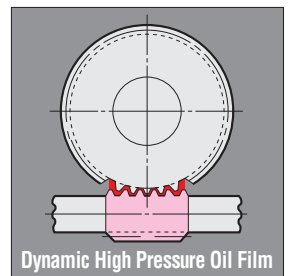
Material is special NIKKEN order made steel. Specially hardened and furthermore ion-nitrided on the tooth. Thus, the problem of the sliding friction is solved. The hardness of the tooth surface and inside is shown at right hand side.



\* Rotation speed of motor = 3,000min<sup>-1</sup>

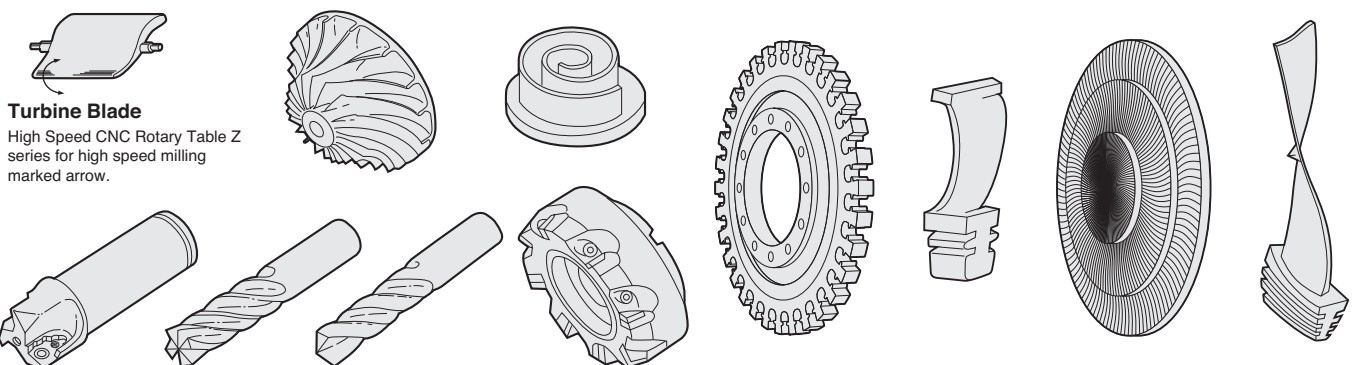
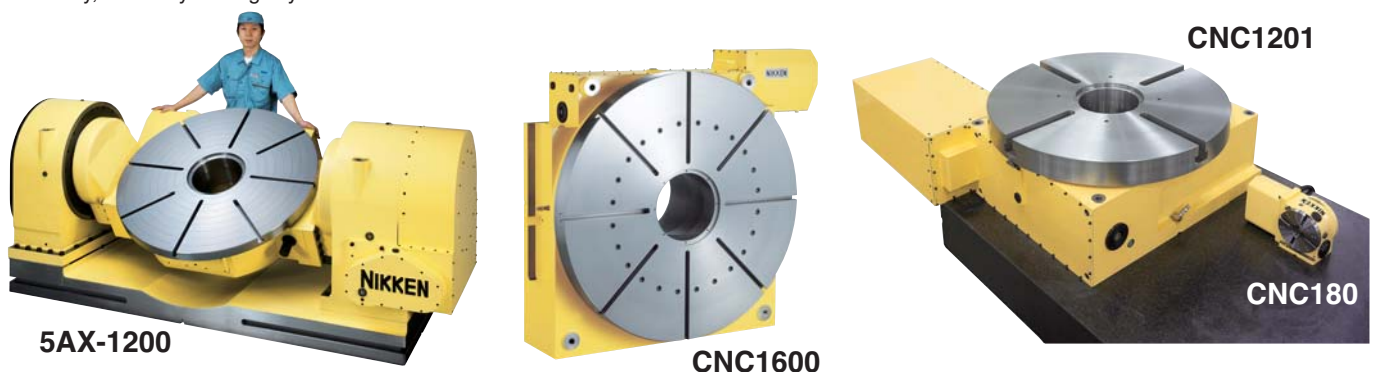
### Dynamic High Pressure Oil Film Effect for High Speed CNC Rotary Table Z Series

NIKKEN'S experience in gear cutting and study of the pressure angle of worm screw carry out the table's higher rotation speed (66.6min<sup>-1</sup>\*). The rotational speed of the screw creates the pressure to force the oil between the gears preventing any metal-to-metal contact, eliminating gear wear and producing high rigidity and durability.



### Large size rotary tables are made a lineup **NEW**

The large size rotary tables for the large size machine tool, the large size die mould, energy and air craft are made a lineup. P.11, P.29 The NIKKEN carbide worm system is installed in the rotary table with the super durability, accuracy and rigidity.

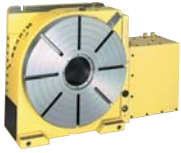


**Turbine Blade**  
High Speed CNC Rotary Table Z series for high speed milling marked arrow.

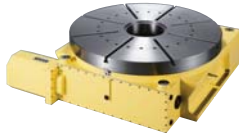


**CNC105, 180, 202**  
 COMPACT CNC ROTARY TABLE ..... P. 5~6  
 COMPACT ROTARY TABLE with  $\alpha$ 21 CONTROLLER ..... P. 69

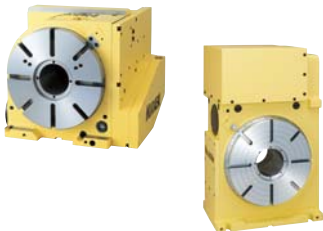
**CNC100-2W, 3W, 4W, CNC180-2W, CNC202-2W, CNC260-2W**  
 MULTI-SPINDLE CNC ROTARY TABLE ..... P. 19~20



**NEW CNC260, 302, 321, 401, 501, 601, 803, 1003, B350, B450, 802**  
 CNC ROTARY TABLE ..... P. 7~10  
 CNC ROTARY TABLE with  $\alpha$ 21 CONTROLLER ..... P. 69~70



**NEW CNC1000, 1200, 1201, 1600, 2000**  
 LARGE CNC ROTARY TABLE ..... P. 11~12  
 LARGE ROTARY TABLE with  $\alpha$ 21 CONTROLLER ..... P. 70



**CNC180B, 202B, 260B, 302B, 321B, 401B**  
 BACK SIDE MOTOR MOUNTED CNC ROTARY TABLE ..... P. 13~14

**CNC200T, 260T, 302T, 321T, 401T, 501T, 601T**  
 TOP SIDE MOTOR MOUNTED CNC ROTARY TABLE ..... P. 15~18



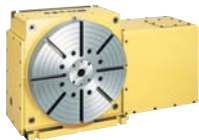
**NEW 5AX-130, 201, 230, 250, 350, 550, 800, 1200**  
 TILTING ROTARY TABLE ..... P. 23~30  
 TILTING ROTARY TABLE with  $\alpha$ 21 CONTROLLER ..... P. 71~72



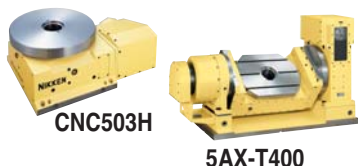
**5AX-2MT, 4MT**  
 MULTI-SPINDLE TILTING ROTARY TABLE ..... P. 31~32



**NST250, 300, 500**  
 MANUAL TILTING ROTARY TABLE ..... P. 21~22



**NSVZ180, 300 NSVX400, 500** Indexing Accuracy ( $\pm 2''$ )  
 ULTRA PRECISION ROTARY HIRTH COUPLING INDEX ..... P. 33~34  
 NSVZ: Min. Command Incremental =  $1^\circ$   
 NSVX: Min. Command Incremental =  $1^\circ, 0.001^\circ$



**BUILT-IN TYPE CNC ROTARY TABLE**  
 CNC401H, CNC503H ..... P. 35  
 5AX-T400, -B450 ..... P. 36  
 This is a CNC rotary table specially designed to be built into the machines.



**CNC ROTARY TABLE for SMALL T/C & SPEEDIO**  
 CNC Rotary Table for BROTHER T/C & **SPEEDIO** ..... P. 39~41  
 CNC Rotary Table for FANUC ROBO DRILL ..... P. 42, P.44



**NEW DD250, 400, 500, 5AX-DD200**  
 Tilting Rotary Table with DD Motor for FANUC ROBO DRILL ..... P. 43~45

# Optional Specification, Accessories & Technical Information



Ample Accessories are available for NIKKEN CNC Rotary Table. For the additional or special specification, please fill in the specification mark sheet, and attach to your order. For the rotary tables marketing in EU, please order specifying "With CE Mark". All rotary tables are available with CE Mark.

## Optional Accessories

■ <b>AWC SYSTEM</b> .....	<b>P.47~48</b>
Automatic Work Change system	
■ <b>αSeries Attachment</b> .....	<b>P.46</b>
■ <b>SCROLL CHUCK &amp; POWER CHUCK</b> .....	<b>P.49</b>
■ <b>TAILSTOCK</b> .....	<b>P.50</b>
■ <b>Air/Air Booster &amp; Air/Hydraulic Booster</b> .....	<b>P.55</b>
Air to Air and Air to Hydraulic Intensified Booster	
■ <b>Hydraulic Unit</b> .....	<b>P.46</b>
■ <b>Fitting Metals and Stepped Guide Pieces</b> .....	<b>P.22</b>



Indexing of the turbine shaft

## Special Specifications

■ <b>Servo Motor List</b> .....	<b>P.37</b>
■ <b>Accuracy Standard</b> .....	<b>P.51~52</b>
Accuracy and measuring method	
■ <b>Ultra Precision</b> .....	<b>P.53</b>
■ <b>Rotary Joint</b> .....	<b>P.54</b>
Rotary connection for pneumatic/hydraulic fixture/chuck	
■ <b>Built-in Pallet Clamp System</b> .....	<b>P.55</b>
Suitable for automatic pallet changer	
■ <b>Water Proof Specification</b> .....	<b>P.55</b>
Available for waterproof connector and cable	
■ <b>Special Application</b> .....	<b>P.57~58</b>
World wide example and application	
■ <b>Assessment of CNC ROTARY TABLE</b> .....	<b>P.56</b>
■ <b>Technical Information of CNC ROTARY TABLE</b> ...	<b>P.59~60</b>
Load calculation, Indexing time, Durability and Instruction	

NIKKEN is keeping the manufacturing not only the quality, but also the safety in mind. Please be careful for the content marked with a warning symbol (⚠). e.g. P.60

## Nikken Controller

■ <b>α21 Controller</b> .....	<b>P.61~62</b>
■ <b>Technical Information for α21 Controller</b> .....	<b>P.63~68</b>
Termination of the maintenance work for NIKKEN controllers	
■ <b>CNC Rotary Table with α21 Controller</b> .....	<b>P.69~72</b>
■ <b>Selection of the CNC ROTARY TABLE</b> .....	<b>P.73</b>



NIKKEN EUROPE (UK)



LYNDEx-NIKKEN (U.S.A.)

## Nikken Worldwide Network

■ <b>HEAD OFFICE &amp; FACILITY</b> .....	<b>P.74~76</b>
■ <b>OVERSEAS SALES &amp; SERVICE NETWORK</b> .....	<b>P.77</b>
■ <b>NIKKEN CHINA (CHINA)</b> .....	<b>P.78</b>
■ <b>LYNDEx-NIKKEN (USA)</b> .....	<b>P.79</b>
■ <b>NIKKEN EUROPE (UK)</b> .....	<b>P.80</b>
■ <b>NIKKEN DEUTSCHLAND (GERMANY)</b> .....	<b>P.81</b>
■ <b>PROCOMO-NIKKEN (FRANCE)</b> .....	<b>P.82</b>

# COMPACT CNC ROTARY TABLE

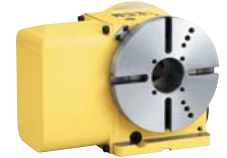


CNC105 α21 and attachments

- Wide application can be offered from small Drilling Press to M/C.
- Suitable for indexing/leads cutting of small size work pieces.
- Various kinds of the work chucking attachments can be offered from 5C collet fixtures to the air/hyd. chuck. [P.46](#)
- Explanation of the Code No. (Example)

## CNC 105 L F A - M

- No Letter: without motor M: with Motor
- No Letter: DC servo motor A: AC servo motor
- Motor Maker [P.37](#)
- A21: with NIKKEN α21 controller
- F:FANUC M:MELDAS Y:YASNAC OSP:OSP T:TOSNUC
- N:NEC S:SANYO Z:SIEMENS I:INDRAMAT H:HEIDENHAIN
- X:ISOFLEX SEM:SEM B:BOSCH
- No letter: Right hand mounted motor
- L: Left hand mounted motor
- Diameter of Table
- 105, 180, 200
- CNC: Standard
- CNCZ: High Speed Z series











CNC202L

## Specifications

( ) : High Speed CNC ROTARY Table Z series

Rotary table with α21 controller, refer [P.69](#)

Item / Code No.		CNC105 CNCZ105	CNC180 CNCZ180	CNC202 CNCZ202
Diameter of Table	φmm	105	180	200
Diameter of Spindle Hole	φmm	φ60 <sub>H7</sub> φ30	φ60 <sub>H7</sub> φ40	φ60 <sub>H7</sub> φ40
Centre Height	mm	105	135	135
Width of T Slot	mm	φ10 <sub>H7</sub> Pin hole	12 <sup>+0.018</sup> <sub>0</sub>	12 <sup>+0.018</sup> <sub>0</sub>
Clamping System		Air	Air	Air
Clamping Torque	N·m	205	303	303
Table Inertia at Motor Shaft ( $\frac{GD^2}{4}$ )	kg·m <sup>2</sup> ×10 <sup>-3</sup>	0.06	0.08	0.09
Servo Motor	min <sup>-1</sup>	αIF1/5000·2000	αIF2/5000·2000	αIF4/5000·2000
MIN. Increment		0.001°	0.001°	0.001°
Rotation Speed	min <sup>-1</sup>	22.2(44.4)	22.2(44.4)	22.2(44.4)
Total Reduction Ratio		1/90(1/45)	1/90(1/45)	1/90(1/45)
Indexing Accuracy	sec	±30	±20	±20
Net Weight	kg	32	45	55
MAX. Work Load on the Table	Vertical  kg	30	100	100
	Horizontal  kg	60	200	200
MAX. Thrust Load applicable on the Table	 N	8800	18000	18000
	*1  FXL N·m	275	542	542
	 FXL N·m	220	690	690
Guide Line of MAX. Unbalancing Load	*2  kg·m	—	3.0	5.0
MAX. Work Inertia	Vertical  + ( $\frac{GD^2}{4}$ ) kg·m <sup>2</sup>	0.04(0.02)	0.40(0.20)	1.0(0.5)
Driving Torque	*3  N·m	36(27)	72(54)	144(115)

★\*1 This is the strength of the worm wheel without brake. It is applied against dynamic cutting thrust.  
 ★\*2 The guide line of MAX unbalancing load means the unbalancing load, when the rotary table is used with support table in vertical application. The guide line figure will be different according to the servo motor, please refer [P.37](#) for more detail.  
 ★\*3 Driving torque means the torque at MAX. rotation speed after acceleration. Driving torque is almost constant and independent from the load except unbalancing load is applied.  
 ★ L type (Motor is mounted at left hand side) is available for all rotary tables. ★ αIF4/5000 motor can be mounted on CNC180.  
 ★ AWC system is available for all rotary tables, please refer [P.47~P.48](#). ★ Ultra precision type is available for all rotary tables, ±3" or ±5", please refer [P.53](#).  
 ★ Rotary joint is available for all rotary tables, please refer [P.54](#).

# CNC105,180,202



External dimensions will be different according to the type of the servo motors. Dimensions with FANUC motor or with NIKKEN  $\alpha$ 21 controller ( $\alpha$ 21 : ) are shown. Please contact with us for CAD data (2D:DXF, 3D:PARASOLID).

## CNC105, CNCZ105

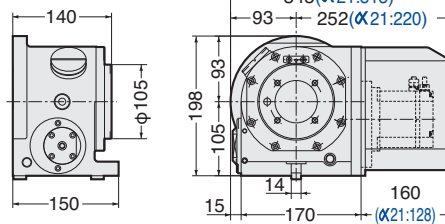
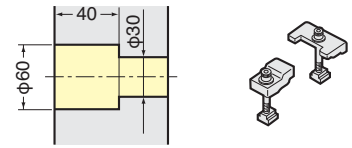


Photo shows a rotary table with  $\alpha$ 21 controller.

**Powerful Brake**  
Brake Torque : 205Nm



Air purge function is provided inside the motor cover as standard.

## CNC180, CNCZ180

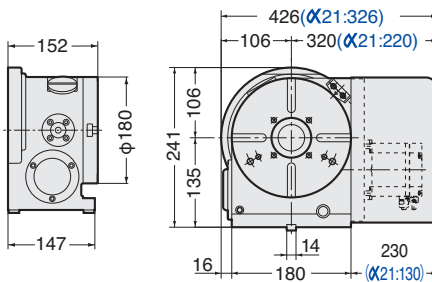
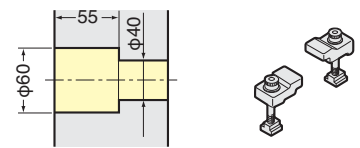


Photo shows a rotary table with  $\alpha$ 21 controller.

**Powerful Brake**  
Brake Torque : 303Nm



Air purge function is provided inside the motor cover as standard.

## CNC202, CNCZ202

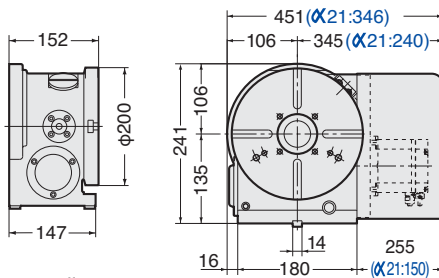
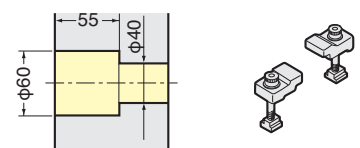


Photo shows a rotary table with  $\alpha$ 21 controller.

**Powerful Brake**  
Brake Torque : 303Nm



Air purge function is provided inside the motor cover as standard.

- ★ For accuracy standard, refer P.51, 52
- ★ For fitting metal and stepped guide piece, refer P.22

- ★ For scroll chuck, tailstock and other optional accessories, refer P.49, 50
- ★  $\alpha$  series attachment can be attached for all tables, refer P.46

## Counter Balance Cylinder

Counter Balance Cylinder is standardized to solve un-balancing load. JAPAN. PAT

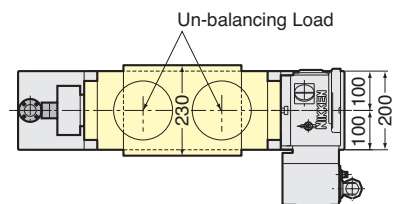
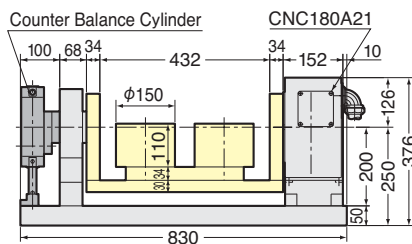
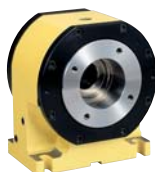
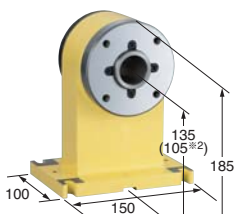
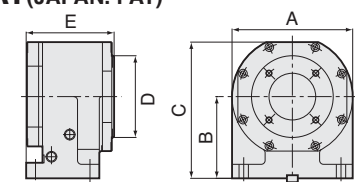


Photo and illustration show the example of the application for un-balancing load.

## Small Size Support Table TAT(JAPAN. PAT)



**TAT105**



Pneumatic ports are 2 x Rc1/8. Solenoid valve and clamp/unclamp confirmation switches are not included.

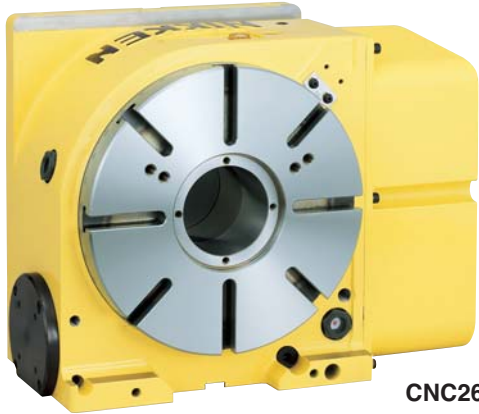
Code No.	A	B	C	D	E	Clamping System	Brake Torque	Weight
TAT105	155	105	175	105	113	Air	205	16
TAT170	155	135	220	170	138	Air	205	25

- ★ Air pressure is 0.5MPa.
- ★ Double intensifying clamping mechanism is installed on TAT105 & TAT170.
- ★ Rotary joint is available for all models, refer P.54

**CST100-105, 135**  
(w/o brake)

- ★ Please add "- centre height" at the end of Code No. for the support table with different centre height (B). e.g.TAT105-135

# CNC ROTARY TABLE



CNC260

■ The rotary table can be used vertically or horizontally depending on the application.

● Explanation of the Code No. (Example)

## CNC 260 L F A - M

- No Letter: without motor  
M: with motor
- No Letter: DC servo motor  
A: AC servo motor
- Motor Maker P.37  
A21: with NIKKEN  $\alpha$ 21 controller  
F:FANUC M:MELDAS Y:YASNAC OSP:OSP  
T:TOSNUC N:NEC S:SANYO Z:SIEMENS  
I:INDRAMAT H:HEIDENHAIN X:ISOFLEX  
SEM:SEM B:BOSCH
- No Letter: Right hand mounted motor  
L: Left hand mounted motor
- Diameter of Table  
260, 300, 320, 400
- CNC: Standard  
CNCZ: High Speed Z Series  
CNCB: Big Bore

Rotary table with  $\alpha$ 21 controller, refer P.69, P.70

## Specifications

( ) : High Speed CNC ROTARY Table Z series

Item / Code No.		CNC260 CNCZ260	CNC302 CNCZ302	CNC321 CNCZ321	CNC401 CNCZ401	CNCB350
Diameter of Table	$\phi$ mm	260	300	320	400	350
Diameter of Spindle Hole	$\phi$ mm	$\phi 80H7$	$\phi 80H7$	$\phi 105H7$	$\phi 105H7$	$\phi 154H7$
Centre Height	mm	170	170	230	230	230
Width of T Slot	mm	$12^{+0.018}_0$	$12^{+0.018}_0$	$12^{+0.018}_0$	$14^{+0.018}_0$	$14^{+0.018}_0$
Clamping System		Air/Hyd.	Air/Hyd.	Hyd.	Hyd.	Hyd.
Clamping Torque	N·m	588 / 1568	588 / 1568	1760	1760	3331
Table Inertia at Motor Shaft ( $\frac{GD^2}{4}$ )	$\text{kg}\cdot\text{m}^2 \times 10^{-3}$	0.33	0.33	2.8	2.8	2.9
Servo Motor	$\text{min}^{-1}$	$\alpha$ IF4/5000·2000	$\alpha$ IF4/5000·2000	$\alpha$ IF12/4000·2000	$\alpha$ IF12/4000·2000	$\alpha$ IF12/4000·2000
MIN. Increment		0.001°	0.001°	0.001°	0.001°	0.001°
Rotation Speed	$\text{min}^{-1}$	16.6(33.3)	16.6(33.3)	22.2(44.4)	22.2(44.4)	22.2
Total Reduction Ratio		1/120(1/60)	1/120(1/60)	1/90(1/45)	1/90(1/45)	1/90
Indexing Accuracy	sec	20	20	15	15	15
Net Weight	kg	115	120	200	230	245
MAX. Work Load on the Table	Vertical  kg	175	175	250	250	250
	Horizontal  kg	350	350	500	500	500
MAX. Thrust Load applicable on the Table	N	42480	42480	53100	53100	53100
	*1  FXL N·m	1442	1442	2648	2648	2648
	FXL N·m	2320	2320	3840	3840	3840
Guide Line of MAX. Unbalancing Load	*2  kg·m	5.0	5.0	10.0	10.0	10.0
MAX. Work Inertia	Vertical $(\frac{GD^2}{4}) \text{kg}\cdot\text{m}^2$	3.2(1.6)	3.2(1.6)	6.4(3.2)	6.4(3.2)	6.4
Driving Torque	*3  N·m	192(153)	192(153)	432(345)	432(345)	432

★\*1 This is the strength of the worm wheel without brake. It is applied against dynamic cutting thrust.

★\*2 The guide line of MAX unbalancing load means the unbalancing load, when the rotary table is used with support table in vertical application. The guide line figure will be different according to the servo motor, please refer P.37 for more detail.

★\*3 Driving torque means the torque at MAX. rotation speed after acceleration. Driving torque is almost constant and independent from the load except unbalancing load is applied.

★ L type (Motor is mounted at left hand side) is available for all rotary tables.

★ Rotary joint is available for all rotary tables, please refer P.54.

★ Ultra heavy duty type is available for CNC321, 401.

★  $\alpha$ IF22/4000 motor can be mounted on CNC321, 401.

★ The air-hydraulic booster is available, when the rotary table with hydraulic clamping system is used on the M/C without hydraulic source, please refer P.55.

★ AWC system is available for all rotary tables, please refer P.47~P.48.

★ Ultra precision type is available for all rotary tables,  $\pm 3''$  or  $\pm 5''$ , please refer P.53.

★  $\alpha$ IF8/4000 motor can be mounted on CNC260, 302.

★ The supplied hydraulic pressure is 3.5MPa for hydraulic clamping system.

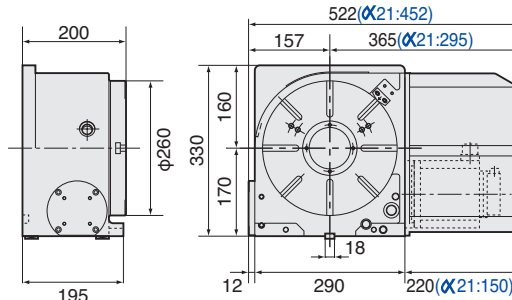


# CNC260,302,321,401,B350

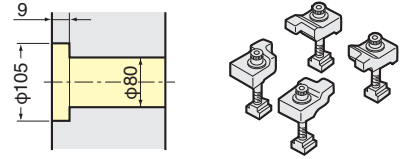


External dimensions will be different according to the type of the servo motors. Dimensions with FANUC motor or with NIKKEN  $\alpha$ 21 controller ( $\alpha$ 21 : ) are shown. Please contact with us for CAD data (2D:DXF, 3D:PARASOLID).

## CNC260, CNCZ260

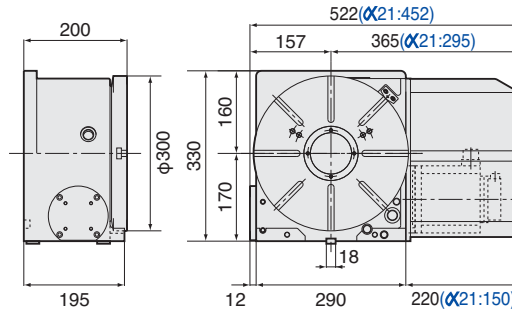


Pneumatic Brake Torque UP  
588Nm

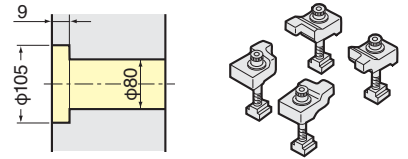


★ For the rotary table with pneumatic brake, air purge function is provided inside the motor cover as standard.

## CNC302, CNCZ302

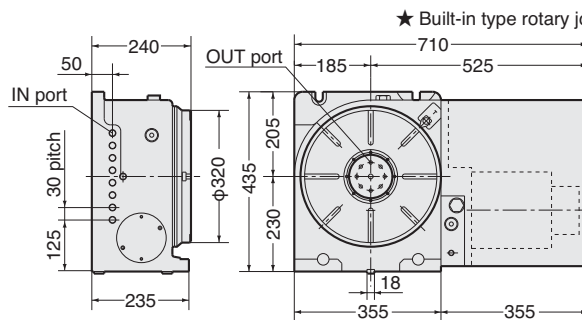
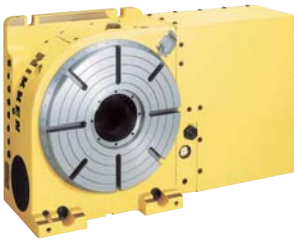


Pneumatic Brake Torque UP  
588Nm

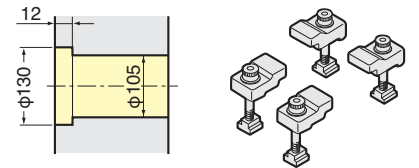


★ For the rotary table with pneumatic brake, air purge function is provided inside the motor cover as standard.

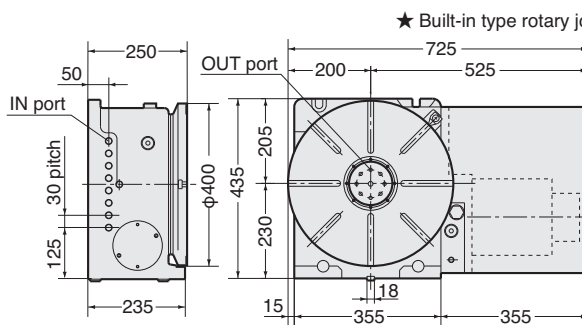
## CNC321, CNCZ321



★ Built-in type rotary joint can be mounted on CNC321 & 401, refer P.49



## CNC401, CNCZ401



★ Built-in type rotary joint can be mounted on CNC321 & 401, refer P.49

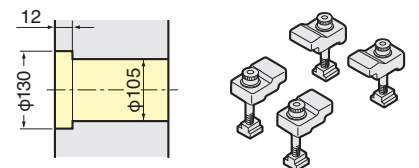
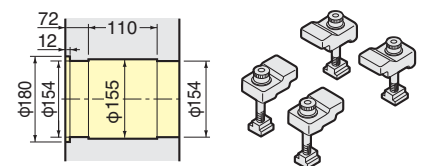
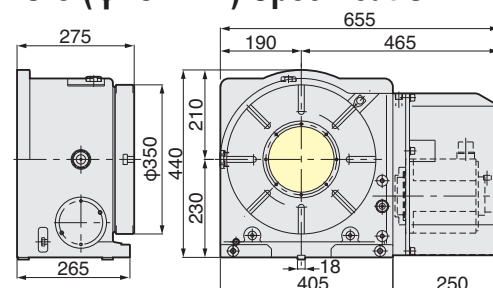


Photo shows with rotary joint (option).

## CNCB350 **NEW** Ultra Big Bore (φ154mm) Specification available as an option.



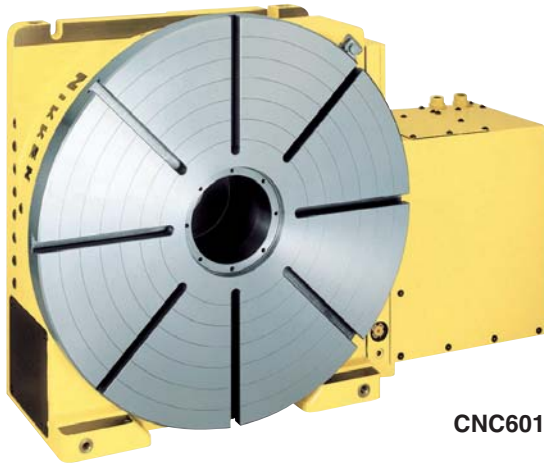
★ For accuracy standard, refer P.51, 52

★ For fitting metal and stepped guide piece, refer P.22

★ For scroll chuck, tailstock and other optional accessories, refer P.49, 50

★ For the condition of CNC table which is mounted on CNC special purpose machine, refer P.59, 60

# CNC ROTARY TABLE



CNC601

- Dividing and lead cutting for large size work piece is suitable.
- Large through hole and powerful clamping system.









● Explanation of the Code No. (Example)

## CNC 601 F A - M

- No Letter: without motor M: with motor
- No Letter: DC servo motor A: AC servo motor
- Motor Maker  $\Rightarrow$  P.37
- A21PW: with NIKKEN  $\alpha$ 21 controller
- F:FANUC M:MELDAS Y:YASNAC OSP:OSP
- T:TOSNUC N:NEC S:SANYO Z:SIEMENS I:INDRAMAT
- H:HEIDENHAIN X:ISOFLEX SEM:SEM B:BOSCH
- No Letter: Right hand mounted motor
- L: Left hand mounted motor
- Position of motor
- No Letter: Horizontal V: Vertical
- Diameter of Table
- 500, 600, 800, 1200
- CNC: Standard
- CNCZ: High Speed Z Series
- CNCB: Big Bore

Rotary table with  $\alpha$ 21PW controller, refer  $\Rightarrow$  P.68

## Specifications ( ) : High Speed CNC ROTARY Table Z series

Item / Code No.		CNC501 CNCZ501	CNC601 CNCZ601	CNC803	CNC1003	CNCB450	CNC802
Diameter of Table	$\phi$ mm	500	600	800	1000	450	800
Diameter of Spindle Hole	$\phi$ mm	$\phi 130H7$	$\phi 130H7$	$\phi 230H7$	$\phi 230H7$	$\phi 205H7$	$\phi 270H7$
Centre Height	mm	310	310	550	550	280	470
Width of T Slot	mm	14 $^{+0.018}_0$	14 $^{+0.018}_0$	22H7 *4	22H7 *4	14 $^{+0.018}_0$	20H7 *4
Clamping System		Hyd.	Hyd.	Hyd.	Hyd.	Hyd.	Hyd.
Clamping Torque	N·m	4655	4655	7000	7000	3870	7000
Table Inertia at Motor Shaft ( $\frac{GD^2}{4}$ )	$kg \cdot m^2 \times 10^{-3}$	6.8	4.9	6.2	6.3	2.8	5.3
Servo Motor	min <sup>-1</sup>	$\alpha$ IF12/4000·2000	$\alpha$ IF12/4000·2000	$\alpha$ IF30/4000·2000	$\alpha$ IF30/4000·2000	$\alpha$ IF12/4000·2000	$\alpha$ IF22/4000·2000
MIN. Increment		0.001°	0.001°	0.001°	0.001°	0.001°	0.001°
Rotation Speed	min <sup>-1</sup>	16.6(33.3)	11.1(22.2)	5.5	5.5	25	5.5
Total Reduction Ratio		1/120(1/60)	1/180(1/90)	1/360	1/360	1/120	1/360
Indexing Accuracy	sec	15	15	15	15	15	15
Net Weight	kg	470	500	2070	2210	380	1100
MAX. Work Load on the Table	Vertical  kg	400	400	2000	2000	350	—
	Horizontal  kg	800	800	4000	4000	700	3000
MAX. Thrust Load applicable on the Table	 N	150000	150000	281250	281250	63720	247920
	*1  F x L N·m	5709	5709	20067	20067	3531	8563
	 F x L N·m	16650	16650	42190	42190	5990	36260
Guide Line of MAX. Unbalancing Load	*2  kg·m	20.0	20.0	30.0	30.0	15.0	—
MAX. Work Inertia	Vertical  + $(\frac{GD^2}{4})$ kg·m <sup>2</sup>	19.4(9.7)	37(18.5)	234	234	17	234
Driving Torque	*3  N·m	576(460)	864(690)	3168	3168	576	3168

- ★\*1 This is the strength of the worm wheel without brake. It is applied against dynamic cutting thrust.
- ★\*2 The guide line of MAX unbalancing load means the unbalancing load, when the rotary table is used with support table in vertical application. The guide line figure will be different according to the servo motor, please refer  $\Rightarrow$  P.37 for more detail.
- ★\*3 Driving torque means the torque at MAX. rotation speed after acceleration. Driving torque is almost constant and independent from the load except unbalancing load is applied.
- ★ L type (Motor is mounted at left hand side) is available for CNC501, 601.
- ★ Ultra precision type is available for all rotary tables,  $\pm 3''$  or  $\pm 5''$ , please refer  $\Rightarrow$  P.53.
- ★  $\alpha$ IF22/4000 motor can be mounted on CNC501, 601.
- ★ The air-hydraulic booster is available, when the rotary table with hydraulic clamping system is used on the M/C without hydraulic source, please refer  $\Rightarrow$  P.55.
- ★ L type and T type (Motor is mounted at top side) is available for CNCB450.
- ★\*4 Standard is without T slot. T slot is available as an option, please specify the width of the T slot.
- ★ Rotary joint is available for all rotary tables, please refer  $\Rightarrow$  P.54.
- ★ Ultra heavy duty type is available for all rotary tables.
- ★ The supplied hydraulic pressure is 3.5MPa for hydraulic clamping system.

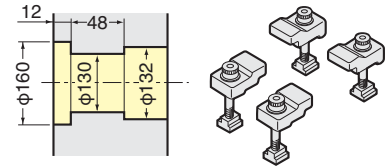
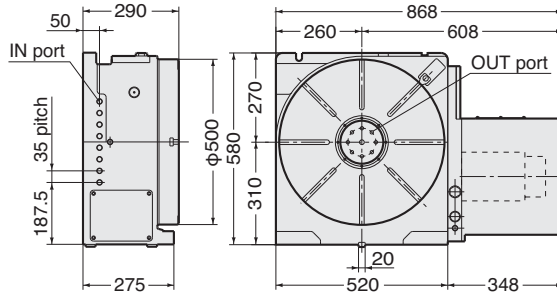
# CNC501, 601, 803, 1003, B450, 802



External dimensions will be different according to the type of the servo motors. Dimensions with FANUC motor are shown. Please contact with us for CAD data (2D:DXF, 3D:PARASOLID).

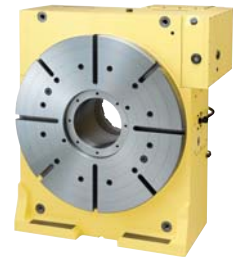
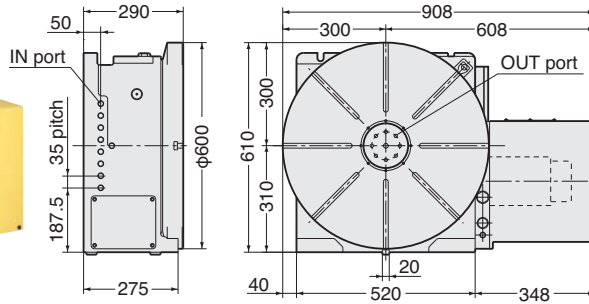
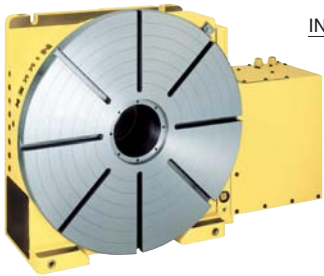
## CNC501, CNCZ501

★ Built-in type rotary joint can be mounted on **CNC501**, refer [P.54](#)



## CNC601, CNCZ601

★ Built-in type rotary joint can be mounted on **CNC601**, refer [P.54](#)



**CNC803B**

## CNC803, 1003 **NEW**

**CNC803** on which motor is mounted at back side, is available for the application on the pallet of the horizontal M/C.

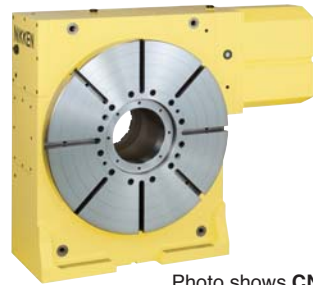
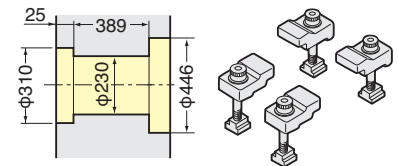
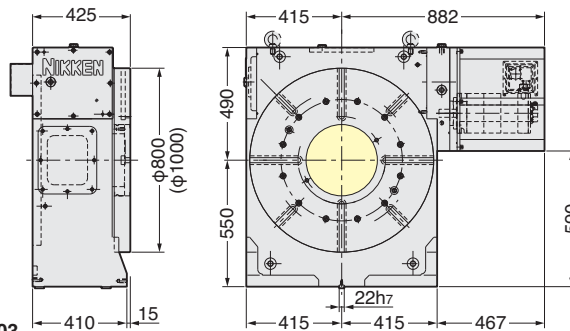
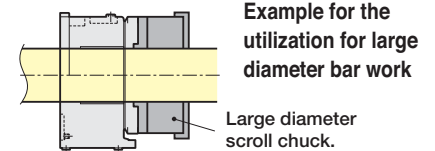
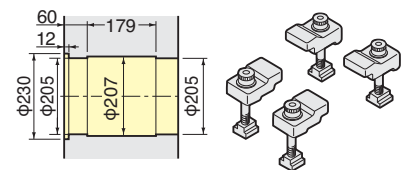
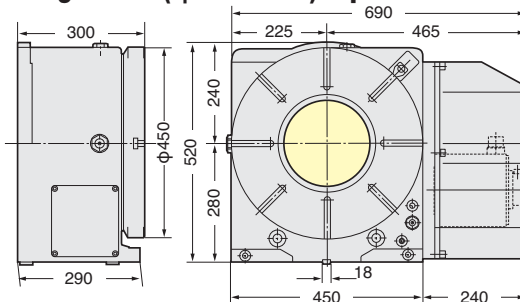
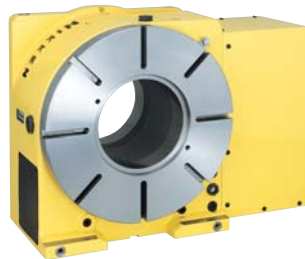


Photo shows **CNC803**.



## CNCB450

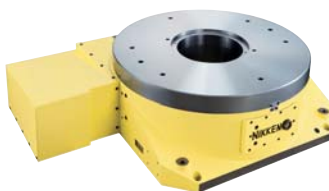
### Ultra Big Bore (φ205mm) Specification



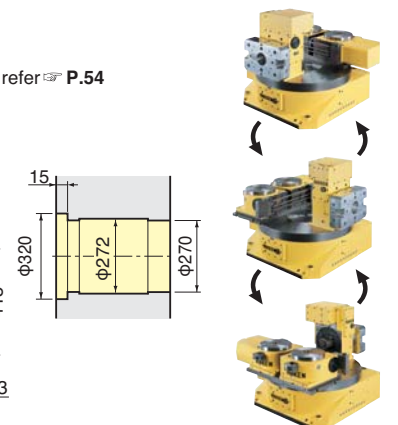
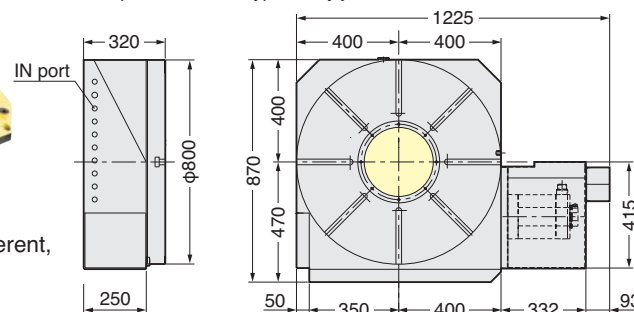
## CNC802 **NEW**

### Ultra Big Bore (φ270mm) Specification

★ 10 ports of built-in type rotary joint can be mounted on **CNC802**, refer [P.54](#)



The dimension of **CNC802** for vertical application is different, please contact us.



T slot is available as an option.

**CNC802 + CNC260T, CNC260-2W**

- ★ For accuracy standard, refer [P.51, 52](#)
- ★ For fitting metal and stepped guide piece, refer [P.22](#)
- ★ For scroll chuck, tailstock and other optional accessories refer [P.49, 50](#)
- ★ For the conditions of CNC table which is mounted on CNC special purpose machine, refer [P.59, 60](#)

# LARGE CNC ROTARY TABLE **NEW**

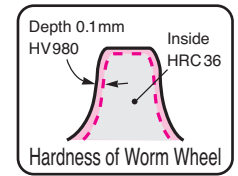
**NIKKEN**



## Worm System



## Worm Wheel



Material is special NIKKEN order made steel. Specially hardened and furthermore ion-nitrided on the tooth. Thus, the problem of the sliding friction is solved.

### • Explanation of the Code No. (Example)

## CNC 1600 F A - M

- No Letter : without motor M : with motor
- No Letter : DC servo motor A : AC servo motor
- Motor Maker P.37
- A21 : with NIKKEN  $\alpha$ 21 controller
- F:FANUC M:MELDAS Y:YASNAC OSP:OSP3
- T:TOSNAC Z:SIEMENS I:INDRAMAT
- H:HEIDENHAIN X:ISOFLEX SEM:SEM B:BOSCH
- Diameter of Table 1000, 1200, 1600, 2000
- CNC: Standard

## Specifications

The specification will be varied according to your application. Please contact us.

Item / Code No.		CNC1000	CNC1200	CNC1201	CNC1600	CNC2000
Diameter of Table	$\phi$ mm	1000	1200	1200	1600	2000
Diameter of Spindle Hole *1	$\phi$ mm	300H7	300H7	300H7	400H7	400H7
Centre Height	mm	Horizontal	Horizontal	650	850	Horizontal
Width of T Slot *2	mm	22H7*2	22H7*2	22H7*2	28H7*2	28H7*2
Clamping System		Hyd.	Hyd.	Hyd.	Hyd.	Hyd.
Clamping Torque	N·m	18000	18000	18000	35000	35000
Servo Motor	min <sup>-1</sup>	$\alpha$ iF22/4000, 2000			$\alpha$ iF30/4000, 2000	
MIN. Increment		0.001°	0.001°	0.001	0.001	0.001
Rotation Speed *3	min <sup>-1</sup>	5.5	5.5	2.7	2.7	2.7
Total Reduction Ratio		1/360	1/360	1/720	1/720	1/720
Indexing Accuracy	sec	15	15	15	15	15
Indexing Accuracy of Ultra Precision	sec	$\pm$ 3	$\pm$ 3	$\pm$ 3	$\pm$ 3	$\pm$ 3
Net Weight	kg	1700	1850	3500*4	5250*4	7700
MAX. Work Load on the Table	Vertical	—	—	6500	10000	—
	Horizontal	7000	7000	13000	30000	30000
MAX. Thrust Load applicable on the Table		281250	375000	1333330	2000000	2000000
	*5	F x L N·m	24080	24080	79025	111952
		F x L N·m	42190	67500	240000	510000
MAX. Work Inertia		1300	1300	2300	6400	6400
MAX. Allowable Torque		3168	3168	8640	8640	8640

★\*1 The diameter of the spindle hole is restricted for the ultra precision type with Heidenhain rotary encoder.

★\*2 Standard large rotary tables are without T slot. T slot is available as an option, please specify the width of the T slot.

★\*3 Total reduction ratio and motor can be changed according to your application, please contact us.

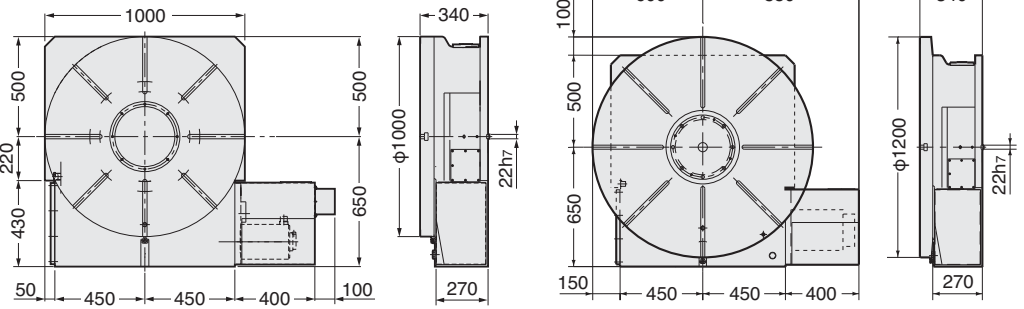
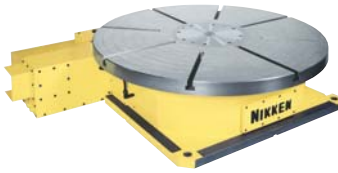
★\*4 Net weight of the rotary table is for horizontal application.

The weight of the back support for vertical application is not included.

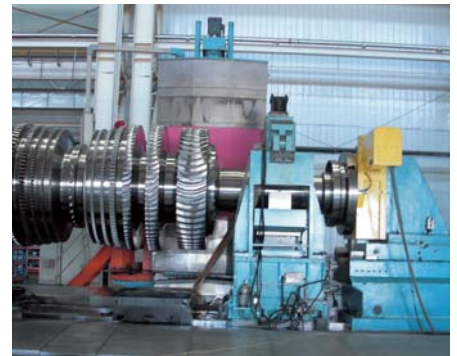
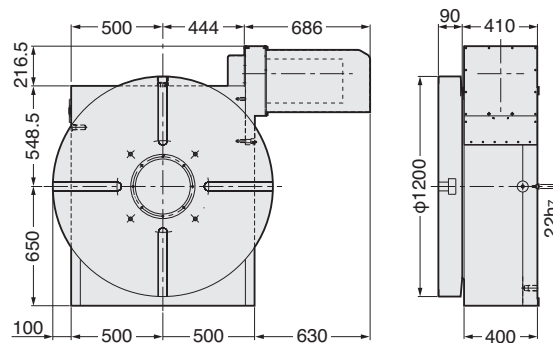
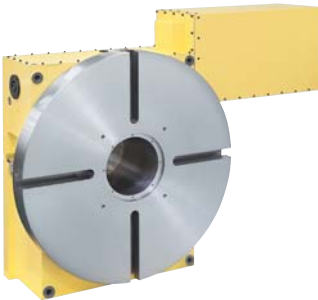
★\*5 This is the strength of the worm wheel without brake. It is applied against dynamic cutting thrust.

External dimensions will be different according to the type of the servo motors. Dimensions with FANUC motor are shown. Please contact with us for CAD data (2D:DXF, 3D:PARASOLID).

## CNC1000,1200 **NEW**



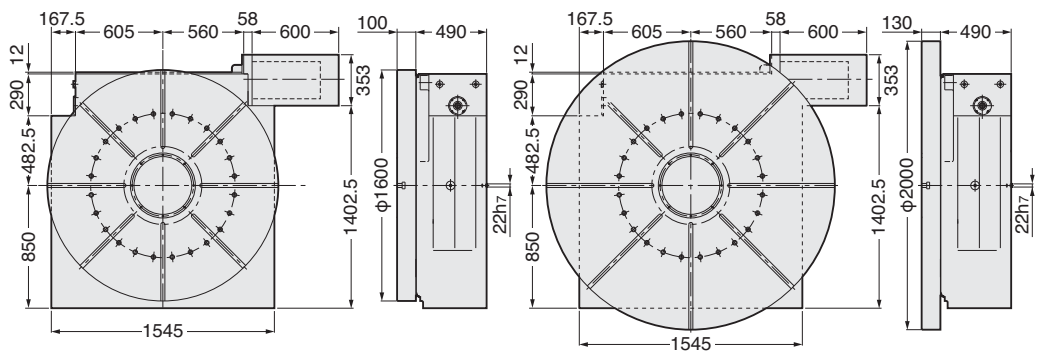
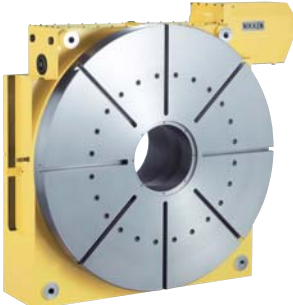
## CNC1201 **NEW**



Indexing of the turbine shaft

★ Please contact us about the back support for vertical use.

## CNC1600, 2000 **NEW**

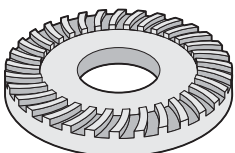
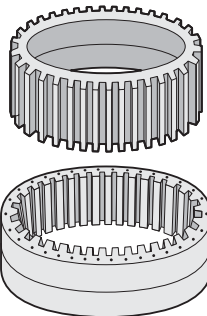


★ Please contact us about the back support for vertical use.

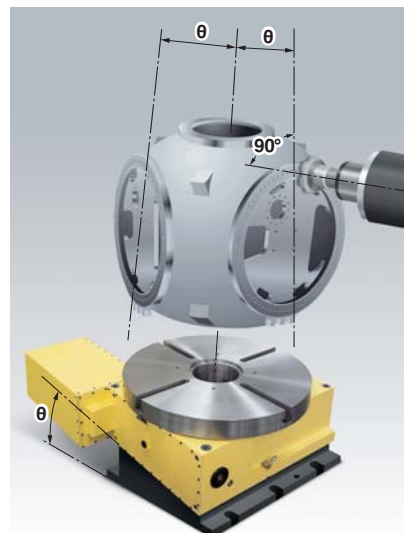
★ For accuracy standard, refer to P.51, 52.

## Application of the Large Rotary Table

Machining of the gears with large module

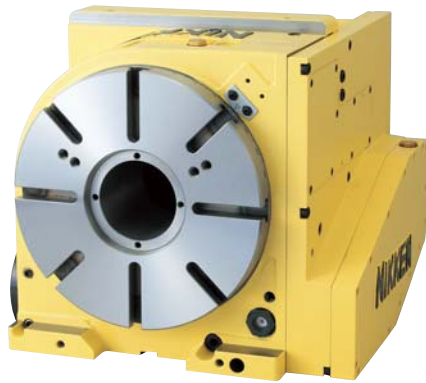


Hobbing of the gears with large module



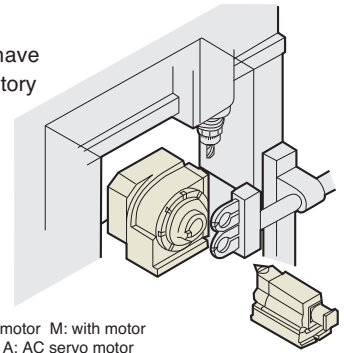
Configuration of the large rotary table on the horizontal M/C to machine a propeller hub of the windmill.

# BACK SIDE MOTOR MOUNTED CNC ROTARY TABLE



CNC260B

■ Suitable for the machine which does not have so wide space for Y axis, such as the gantry type M/C or the M/C with splash guard.



● Explanation of the Code No. (Example)

## CNC 260 B F A - M

- No Letter: without motor M: with motor
- No Letter: DC servo motor A: AC servo motor
- Motor Maker ☞ P.37
- A21: with NIKKEN  $\alpha$ 21 controller
- F:FANUC M:MELDAS Y:YASNAC OSP:OSP T:TOSNUC N:NEC
- S:SANYO Z:SIEMENS I:INDRAMAT H:HEIDENHAIN X:ISOFLX
- SEM:SEM B:BOSCH
- Position of motor B: Back side
- Diameter of Table  
180, 200, 260, 300, 320, 400
- CNC: Standard  
CNCZ: High Speed Z Series

## Specifications

( ) : High Speed CNC ROTARY Table Z series

Item / Code No.		CNC180B CNCZ180B	CNC202B CNCZ202B	CNC260B CNCZ260B	CNC302B CNCZ302B	CNC321B CNCZ321B	CNC401B CNCZ401B
Diameter of Table	$\phi$ mm	180	200	260	300	320	400
Diameter of Spindle Hole	$\phi$ mm	$\phi 60H7, \phi 40$	$\phi 60H7, \phi 40$	$\phi 80H7$	$\phi 80H7$	$\phi 105H7$	$\phi 105H7$
Centre Height	mm	180	180	170	170	230	230
Width of T Slot	mm	$12^{+0.018}_0$	$12^{+0.018}_0$	$12^{+0.018}_0$	$12^{+0.018}_0$	$12^{+0.018}_0$	$14^{+0.018}_0$
Clamping System		Air	Air	Air / Hyd.	Air / Hyd.	Hyd.	Hyd.
Clamping Torque	N·m	303	303	588 / 1568	588 / 1568	1760	1760
Table Inertia at Motor Shaft ( $\frac{GD^2}{4}$ )	$\text{kg}\cdot\text{m}^2 \times 10^{-3}$	0.4	0.4	1.7	1.8	7.0	7.0
Servo Motor	$\text{min}^{-1}$	$\alpha$ IF2/5000·2000	$\alpha$ IF4/5000·2000	$\alpha$ IF4/5000·2000	$\alpha$ IF4/5000·2000	$\alpha$ IF12/4000·2000	$\alpha$ IF12/4000·2000
MIN. Increment		0.001°	0.001°	0.001°	0.001°	0.001°	0.001°
Rotation Speed	$\text{min}^{-1}$	22.2(44.4)	22.2(44.4)	16.6(33.3)	16.6(33.3)	22.2(44.4)	22.2(44.4)
Total Reduction Ratio		1/90(1/45)	1/90(1/45)	1/120(1/60)	1/120(1/60)	1/90(1/45)	1/90(1/45)
Indexing Accuracy	sec	$\pm 20$	$\pm 20$	20	20	15	15
Net Weight	kg	56	60	145	150	240	270
MAX. Work Load on the Table	Vertical	100	100	175	175	250	250
	Horizontal	—	—	—	—	—	—
MAX. Thrust Load applicable on the Table		18000	18000	42480	42480	53100	53100
	*1	542	542	1442	1442	2648	2648
		690	690	2320	2320	3840	3840
Guide Line of MAX. Unbalancing Load	*2	3.0	5.0	5.0	5.0	10.0	10.0
MAX. Work Inertia	Vertical	0.4	0.4	3.2(1.6)	3.2(1.6)	6.4(3.2)	6.4(3.2)
Driving Torque	*3	72(54)	72(54)	192(153)	192(153)	432(345)	432(345)

★\*1 This is the strength of the worm wheel without brake. It is applied against dynamic cutting thrust.

★\*2 The guide line of MAX unbalancing load means the unbalancing load, when the rotary table is used with support table in vertical application. The guide line figure will be different according to the servo motor, please refer ☞ P.37 for more detail.

★\*3 Driving torque means the torque at MAX. rotation speed after acceleration. Driving torque is almost constant and independent from the load except unbalancing load is applied.

★ Please contact us for rotary joint and ultra precision type, please refer P.54 and 53 respectively.

★  $\alpha$ IF4/5000 motor can be mounted on CNC180B.

★  $\alpha$ IF8/4000 motor can be mounted on CNC260B, 302B.

★ The supplied hydraulic pressure is 3.5MPa for hydraulic clamping system.

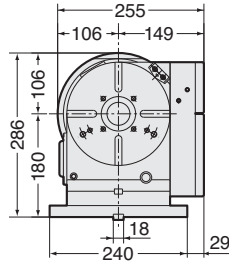
★ The air-hydraulic booster is available, when the rotary table with hydraulic clamping system is used on the M/C without hydraulic source, please refer ☞ P.55.

# CNC180B, 202B, 260B, 302B, 321B, 401B

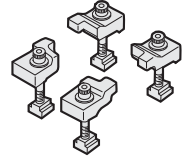
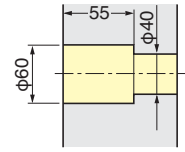


External dimensions will be different according to the type of the servo motors. Dimensions with FANUC motor are shown. Please contact with us for CAD data (2D:DXF, 3D:PARASOLID).

## CNC180B, CNCZ180B

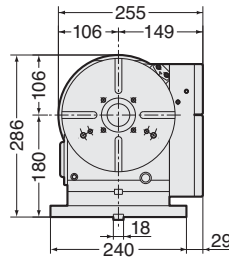


**Powerful Brake**  
**Brake Torque : 303Nm**

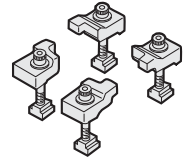
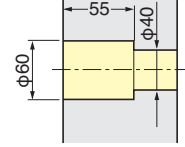


Air purge function is provided.

## CNC202B, CNCZ202B



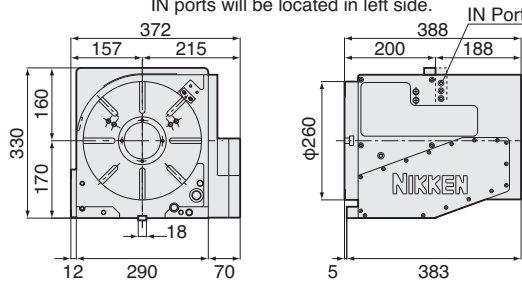
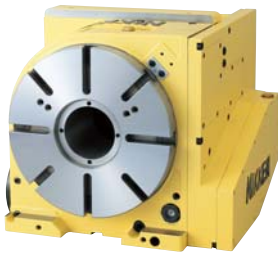
**Powerful Brake**  
**Brake Torque : 303Nm**



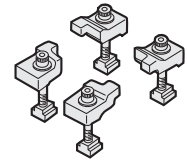
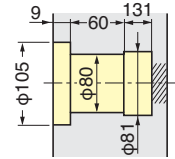
Air purge function is provided.

## CNC260B, CNCZ260B

★ MAX.8 ports of rotary joint can be mounted without changing dimension.  
 IN ports will be located in left side.



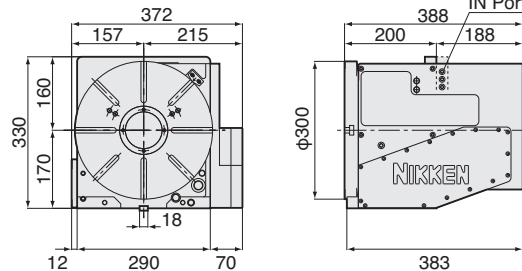
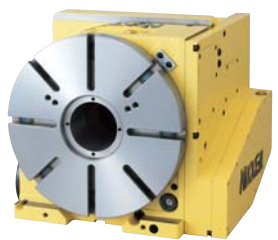
**Pneumatic Brake Torque UP**  
**588Nm**



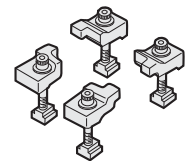
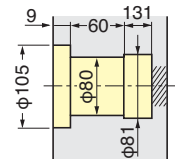
For the rotary table with pneumatic brake, air purge function is provided inside the motor cover as standard.

## CNC302B, CNCZ302B

★ MAX.8 ports of rotary joint can be mounted without changing dimension.  
 IN ports will be located in left side.



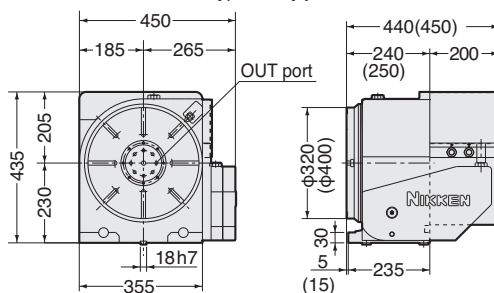
**Pneumatic Brake Torque UP**  
**588Nm**



For the rotary table with pneumatic brake, air purge function is provided inside the motor cover as standard.

## CNC321B, CNCZ321B CNC401B, CNCZ401B

★ Built-in type rotary joint can be mounted on CNC321B & 401B, refer P.54



IN ports are located in left side.  
 ( ) : CNC401B

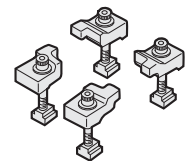
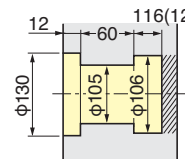


Photo shows with centre socket (option).

- ★ For accuracy standard, refer P.51, 52
- ★ For fitting metal and stepped guide piece, refer P.22

- ★ For scroll chuck, tailstock and other optional accessories, refer P.49, 50
- ★ a series attachment can be attached for all tables, refer P.46

# TOP SIDE MOTOR MOUNTED CNC ROTARY TABLE



**CNC302T**

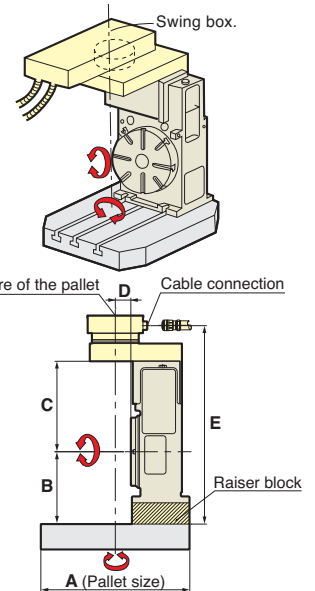
Photo shows with centre socket (option)

■ This is the application that the rotary table with swing box is installed on the pallet of the horizontal M/C.  
Please specify A, B, C, D and E.









● Explanation of the Code No. (Example)

## CNC 302 T F A - M

- No Letter: without motor  
M: with motor
- Motor Maker P.37  
A21: with NIKKEN  $\alpha$ 21 controller  
F:FANUC M:MELDAS Y:YASNAC OSP:OSP  
T:TOSNUC N:NEC S:SANYO Z:SIEMENS I:INDRAMAT  
H:HEIDENHAIN X:ISOFLEX SEM:SEM B:BOSCH
- Position of motor T: Top side
- Diameter of Table  
200, 260, 300
- CNC: Standard  
CNCZ: High Speed Z Series



## Specifications ( ) : High Speed CNC ROTARY Table Z series

Item / Code No.		CNC200T CNCZ200T	CNC260T CNCZ260T	CNC302T CNCZ302T
Diameter of Table	$\phi$ mm	200	260	300
Diameter of Spindle Hole	$\phi$ mm	$\phi 50H7$	$\phi 80H7$	$\phi 80H7$
Centre Height	mm	150	170	170
Width of T Slot	mm	$12^{+0.018}_0$	$12^{+0.018}_0$	$12^{+0.018}_0$
Clamping System		Air	Air / Hyd.	Air / Hyd.
Clamping Torque	N·m	196	588 / 1568	588 / 1568
Table Inertia at Motor Shaft ( $\frac{GD^2}{4}$ )	$kg \cdot m^2 \times 10^{-3}$	1.0	1.5	1.5
Servo Motor	min <sup>-1</sup>	$\alpha$ iF4/5000·2000	$\alpha$ iF4/5000·2000	$\alpha$ iF4/5000·2000
MIN. Increment		0.001°	0.001°	0.001°
Rotation Speed	min <sup>-1</sup>	22.2(44.4)	16.6(33.3)	16.6(33.3)
Total Reduction Ratio		1/90(1/45)	1/120(1/60)	1/120(1/60)
Indexing Accuracy	sec	20	20	20
Net Weight	kg	85	160	165
MAX. Work Load on the Table	Vertical  kg	100	175	175
	Horizontal  kg	—	—	—
MAX. Thrust Load applicable on the Table	 N	21240	42480	42480
	*1  F x L N·m	542	1442	1442
	 F x L N·m	820	2320	2320
Guide Line of MAX. Unbalancing Load	*2  kg·m	5.0	5.0	5.0
MAX. Work Inertia	Vertical  + $\frac{GD^2}{4}$ kg·m <sup>2</sup>	1.0(0.5)	3.2(1.6)	3.2(1.6)
Driving Torque	*3  N·m	144(115)	192(153)	192(153)

★\*1 This is the strength of the worm wheel without brake. It is applied against dynamic cutting thrust.  
 ★\*2 The guide line of MAX unbalancing load means the unbalancing load, when the rotary table is used with support table in vertical application. The guide line figure will be different according to the servo motor, please refer P.37 for more detail.  
 ★\*3 Driving torque means the torque at MAX. rotation speed after acceleration. Driving torque is almost constant and independent from the load except unbalancing load is applied.  
 ★ AWC system is available for all rotary tables, please refer P.47~P.48. ★ Rotary joint is available for all rotary tables, please refer P.54.  
 ★ Ultra precision type is available for all rotary tables,  $\pm 3''$  or  $\pm 5''$ , please refer P.53. ★  $\alpha$ iF8/4000 motor can be mounted on CNC200T, CNC260T, 302T.  
 ★ The supplied hydraulic pressure is 3.5MPa for hydraulic clamping system.  
 ★ The air-hydraulic booster is available, when the rotary table with hydraulic clamping system is used on the M/C without hydraulic source, please refer P.55.  
 ★ CNCZ series table can not be recommended for the application with large unbalancing load. CNCZ series table is recommended for the application only with light load.



# CNC200T, 260T, 302T

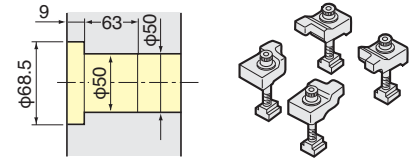
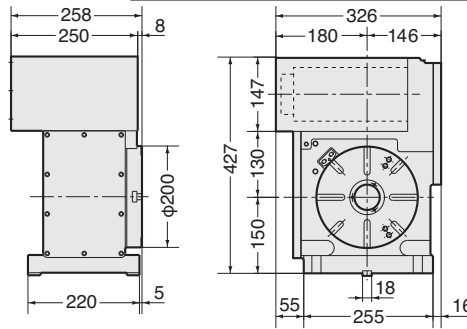


External dimensions will be different according to the type of the servo motors. Dimensions with FANUC motor are shown. Please contact with us for CAD data (2D:DXF, 3D:PARASOLID).

## CNC200T, CNCZ200T

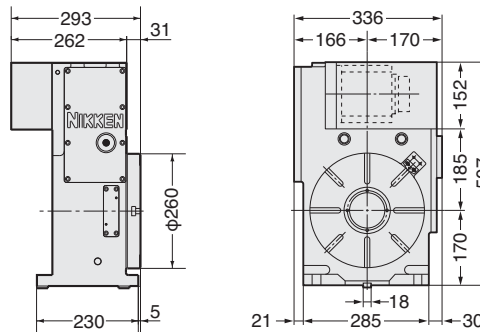


Photo shows with centre socket (option).

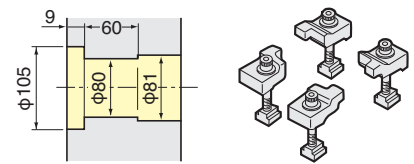


Air purge function is provided inside the motor cover as standard.

## CNC260T, CNCZ260T



### Pneumatic Brake Torque UP 588Nm

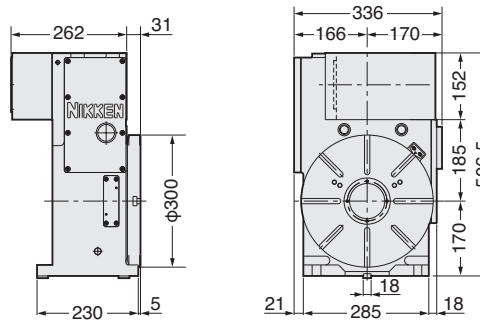


For the rotary table with pneumatic brake, air purge function is provided inside the motor cover as standard.

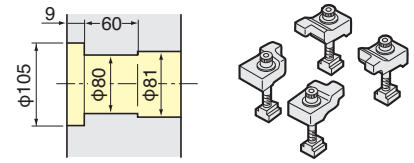
## CNC302T, CNCZ302T



Photo shows with centre socket (option).



### Pneumatic Brake Torque UP 588Nm



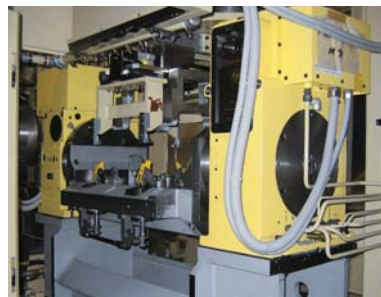
For the rotary table with pneumatic brake, air purge function is provided inside the motor cover as standard.

- ★ For accuracy standard, refer P.51, 52.
- ★ For fitting metal and stepped guide piece, refer P.22.
- ★ For scroll chuck, tail stock and other optional accessories, refer P.49, 50.
- ★ For the condition of rotary table which is installed on the special purpose machine, refer P.59, 60.

## Specification of the Top Side Mounted CNC Rotary Table



Photo shows CNC302T without T slot.



Synchronors movement of 2 off CNC401

Tubular roller bearing is installed against the thrust load. Therefore, when 2 rotary tables are faced on both side to synchronise movement, the system can be run without affecting the heat expansion of the rotary table.



CNC401T is installed on the pallet of the horizontal M/C.



CNC400T is installed on CNC600V.



CNC501T is used for the tilting axis table of 5AX-tilting rotary table.

# TOP SIDE MOTOR MOUNTED CNC ROTARY TABLE



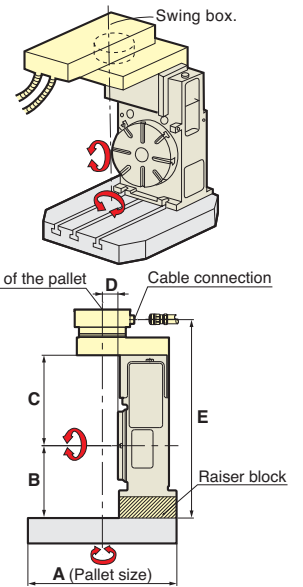
CNC501T

■ This is the application that the rotary table with swing box is installed on the pallet of the horizontal M/C.  
Please specify A, B, C, D and E.

● Explanation of the Code No. (Example)

**CNC 501 T F A - M**

- No Letter: without motor  
M: with motor
- Motor Maker ☞ P.37  
A21: with NIKKEN  $\alpha$ 21 controller  
F:FANUC M:MELDAS Y:YASNAC OSP:OSP  
T:TOSNUC N:NEC S:SANYO Z:SIEMENS I:INDRAMAT  
H:HEIDENHAIN X:ISOFLEX SEM:SEM B:BOSCH
- Position of motor T: Top side
- Diameter of Table  
320, 400, 500, 600
- CNC: Standard  
CNCZ: High Speed Z Series



## Specifications

Item / Code No.		CNC321T	CNC401T	CNC501T	CNC601T
Diameter of Table	$\phi$ mm	320	400	500	600
Diameter of Spindle Hole	$\phi$ mm	$\phi 105H7$	$\phi 105H7$	$\phi 130H7$	$\phi 130H7$
Centre Height	mm	240	240	310	310
Width of T Slot	mm	$12^{+0.018}_0$	$14^{+0.018}_0$	$14^{+0.018}_0$	$14^{+0.018}_0$
Clamping System		Hyd.	Hyd.	Hyd.	Hyd.
Clamping Torque	N·m	1760	1760	4655	4655
Table Inertia at Motor Shaft ( $\frac{GD^2}{4}$ )	$kg \cdot m^2 \times 10^{-3}$	2.0	2.0	9.0	8.8
Servo Motor	$min^{-1}$	$\alpha$ IF12/4000·2000	$\alpha$ IF12/4000·2000	$\alpha$ IF12/4000·2000	$\alpha$ IF12/4000·2000
MIN. Increment		$0.001^\circ$	$0.001^\circ$	$0.001^\circ$	$0.001^\circ$
Rotation Speed	$min^{-1}$	16.6	16.6	16.6	11.1
Total Reduction Ratio		1/120	1/120	1/120	1/180
Indexing Accuracy	sec	15	15	15	15
Net Weight	kg	220	245	495	525
MAX. Work Load on the Table	Vertical  kg	250	250	400	400
	Horizontal  kg	—	—	—	—
MAX. Thrust Load applicable on the Table	N	53100	53100	150000	150000
	*1  F x L N·m	2648	2648	5709	5709
	F x L N·m	3840	3840	16650	16650
Guide Line of MAX. Unbalancing Load	*2  kg·m	10.0	10.0	20.0	20.0
MAX. Work Inertia	Vertical  + $(\frac{GD^2}{4})$ $kg \cdot m^2$	8.0	8.0	19	37
Driving Torque	*3  N·m	576	576	576	864

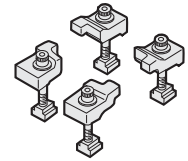
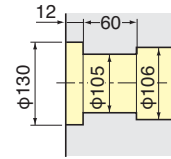
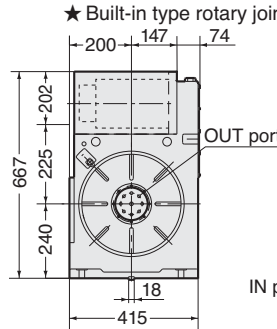
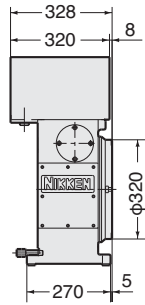
★\*1 This is the strength of the worm wheel without brake. It is applied against dynamic cutting thrust.  
 ★\*2 The guide line of MAX unbalancing load means the unbalancing load, when the rotary table is used with support table in vertical application. The guide line figure will be different according to the servo motor, please refer ☞ P.37 for more detail.  
 ★\*3 Driving torque means the torque at MAX. rotation speed after acceleration. Driving torque is almost constant and independent from the load except unbalancing load is applied.  
 ★ AWC system is available for all rotary tables, please refer ☞ P.47~P.48. ★ Rotary joint is available for all rotary tables, please refer ☞ P.54.  
 ★ Ultra precision type is available for all rotary tables,  $\pm 3''$  or  $\pm 5''$ , please refer ☞ P.53. ★  $\alpha$ IF22/4000 motor can be mounted on CNC321T, 401T, 501T, 601T.  
 ★ The supplied hydraulic pressure is 3.5MPa for hydraulic clamping system.  
 ★ The air-hydraulic booster is available, when the rotary table with hydraulic clamping system is used on the M/C without hydraulic source, please refer ☞ P.55.  
 ★ Total reduction ratio of 1/180 is also available for CNC501T.

# CNC321T, 401T, 501T, 601T



External dimensions will be different according to the type of the servo motors. Dimensions with FANUC motor are shown. Please contact with us for CAD data (2D:DXF, 3D:PARASOLID).

## CNC321T



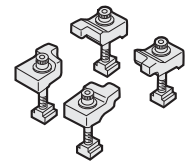
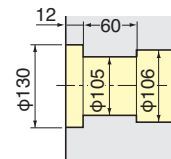
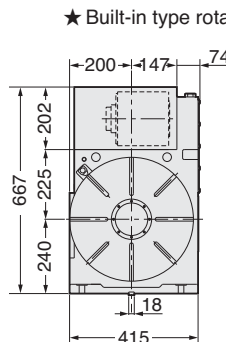
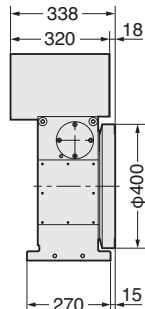
IN ports are located in back side.

★ Built-in type rotary joint can be mounted on **CNC321** refer ⇨ **P.54**

## CNC401T



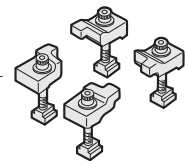
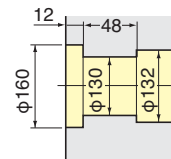
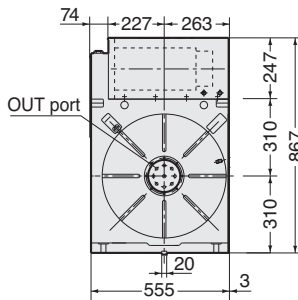
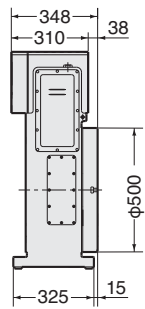
Photo shows with centre socket (option).



IN ports are located in back side.

★ Built-in type rotary joint can be mounted on **CNC401** refer ⇨ **P.54**

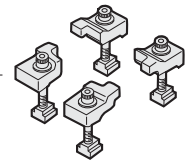
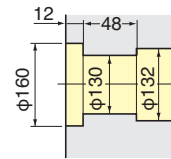
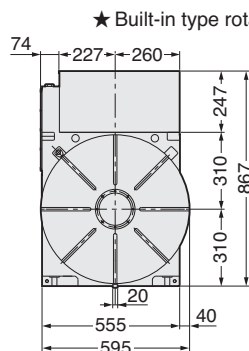
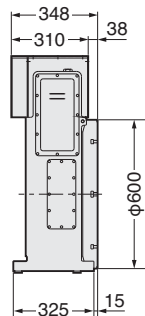
## CNC501T



IN ports are located in back side.

★ Built-in type rotary joint can be mounted on **CNC501** refer ⇨ **P.54**

## CNC601T



IN ports are located in back side.

★ Built-in type rotary joint can be mounted on **CNC601** refer ⇨ **P.54**

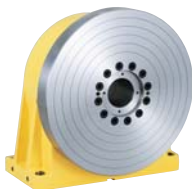
- ★ For accuracy standard, refer ⇨ **P.51, 52**
- ★ For fitting metal and stepped guide piece, refer ⇨ **P.22**
- ★ For scroll chuck, tail stock and other optional accessories, refer ⇨ **P.49, 50**
- ★ For the condition of rotary table which is installed on the special purpose machine, refer ⇨ **P.59, 60**

## Support Table TAT

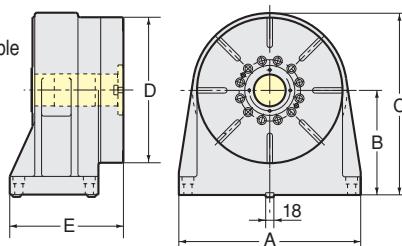


TAT250N

The table without T slots is standard. T slots are available as an option.



TAT401N



Hydraulic connections are RC3/8 X 2 and pneumatic connections are RC1/8 X 2. Confirmation switches for clamp/unclamp and solenoid valve are not included.

Code No.	A	B	C	D	E	Clamping System	Brake Torque	Weight
TAT200	250	150	250	200	145	Air/Hyd.	$\frac{112}{784}$	43
TAT250	250	170	295	250	145	Air/Hyd.	$\frac{112}{784}$	50
TAT321	400	230	390	320	250	Hyd.	1470	120
TAT401	400	230	430	400	250	Hyd.	1470	140
TAT501	480	310	560	500	250	Hyd.	1470	200

- ★ Air pressure is 0.5MPa.
- ★ Hydraulic pressure is 3.5MPa.
- ★ Rotary joint is available for all models.
- ★ Please add "— centre height" at the end of Code No. for the support table with different centre height (B) . e.g. TAT321-240 (For CNC321T)

(N·m) (kg)

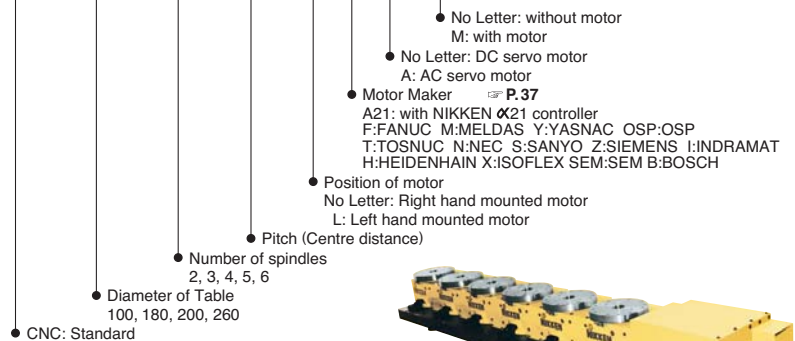
# MULTI-SPINDLE CNC ROTARY TABLE



- Multi-Spindle (2, 3 & 4 spindles) CNC rotary table series for rationalization of machining of small size work pieces ( $\phi 3 \sim 100\text{mm}$ ).
- Different pitch between spindles is also available.
- 5 or 6 spindles CNC rotary table is also available.

● Explanation of the Code No. (Example)

## CNC 100-3W-120-L F A-M



CNC100-2W



CNC170-6W

Please contact us for CNC180-2W, CNC202-2W and CNC260-2W.

( ) : High Speed type Please contact us.

## Specifications

Item / Code No.		CNC100 CNCZ100 -2W, -3W, -4W			CNC180-2W	CNC202-2W	CNC260-2W
Diameter of Table	$\phi$ mm	105			180	200	260
Diameter of Spindle Hole	$\phi$ mm	$\phi 60\text{H}7 \ \phi 30$			$\phi 60\text{H}7 \ \phi 40$	$\phi 60\text{H}7 \ \phi 40$	$\phi 80\text{H}7$
Number of spindles (Pitch)	mm	2,3,4x120			2x250	2x250	2x350
Centre Height	mm	105			175	175	220
Width of T Slot	mm	16 <sup>+0.018</sup> <sub>0</sub>			12 <sup>+0.018</sup> <sub>0</sub>	12 <sup>+0.018</sup> <sub>0</sub>	12 <sup>+0.018</sup> <sub>0</sub>
Clamping System		Air			Air	Air	Air / Hyd.
Clamping Torque	N·m	147			303	303	588 / 1568
Table Inertia at Motor Shaft ( $\frac{GD^2}{4}$ )	$\text{kg}\cdot\text{m}^2 \times 10^{-3}$	0.13	0.16	0.2	0.12	0.13	0.7
Servo Motor	$\text{min}^{-1}$	$\alpha$ iF2 / 5000·2000		$\alpha$ iF4 / 5000·2000	$\alpha$ iF4 / 5000·2000	$\alpha$ iF8 / 4000·2000	$\alpha$ iF8 / 4000·2000
MIN. Increment		0.001°			0.001°	0.001°	0.001°
Rotation Speed	$\text{min}^{-1}$	11.1(44.4)			22.2	22.2	16.6
Total Reduction Ratio		1/180(1/45)			1/90	1/90	1/120
Indexing Accuracy	sec	$\pm 30$		$\pm 45$	$\pm 20$	$\pm 20$	20
Net Weight	kg	70	90	120	115	120	320
MAX. Work Load on the Table	Vertical	15			100	100	175
	Horizontal	30			200	200	350
MAX. Thrust Load applicable on the Table		3920			10780	10780	25480
	*1	49			415	415	984
		98			980	980	3332
MAX. Work Inertia	Vertical	0.019 (0.07Horizontal)			0.5	0.5	1.9
Driving Torque		72			72	144	192

★ \*1 This is the strength of the worm wheel without brake. It is applied against dynamic cutting thrust.

★ L type (Motor is mounted at left hand side) is available for all rotary tables.

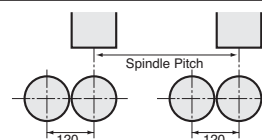
★ Min. pitch between spindles CNC100:120mm, CNC180:250mm, CNC202:250mm, CNC260:320mm. Please contact us when the different pitch is required.

★ 4 spindles table to suit 2 spindles M/C is available.

★ Max. number of spindles CNC100:6 spindles, CNC180:4 spindles, CNC202:4 spindles, CNC260:2 spindles.

★ Rotary joint is available for all rotary tables, please refer  $\Rightarrow$  P.54

★ The air-hydraulic booster is available, when CNC260-2W with hydraulic clamping system is used on the M/C without hydraulic source, please refer  $\Rightarrow$  P.55.

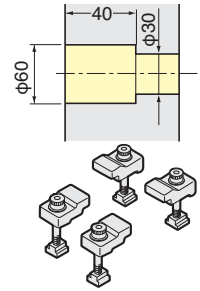
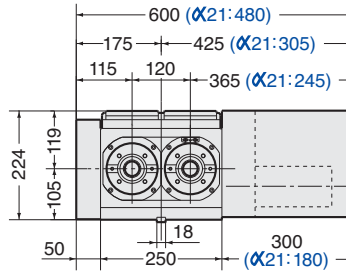
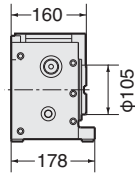


# CNC100-2W,3W,4W, CNC180-2W,CNC202-2W,CNC260-2W



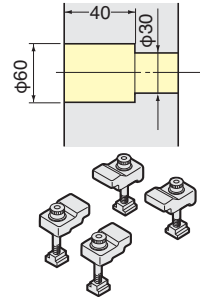
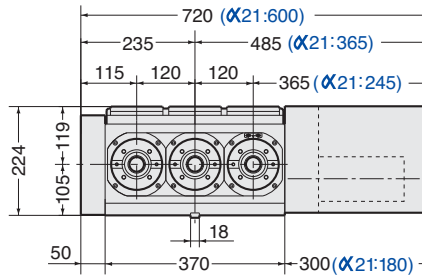
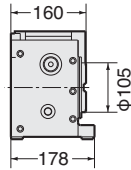
External dimensions will be different according to the type of the servo motors. Dimensions with FANUC motor or with NIKKEN  $\alpha$ 21 controller ( $\alpha$ 21 : ) are shown. Please contact with us for CAD data (2D:DXF, 3D:PARASOLID).

## CNC100-2W



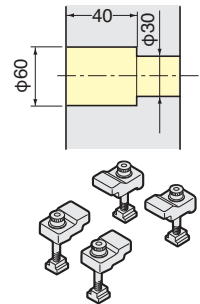
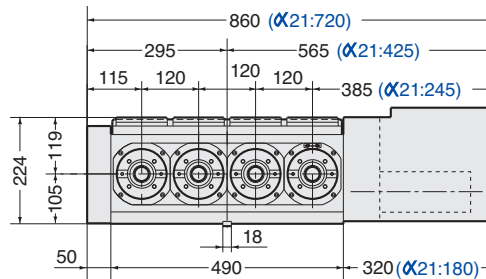
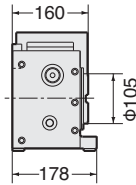
Air purge function is provided inside the motor cover as standard.

## CNC100-3W



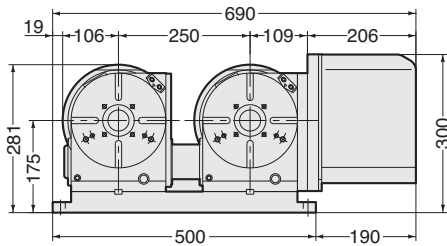
Air purge function is provided inside the motor cover as standard.

## CNC100-4W



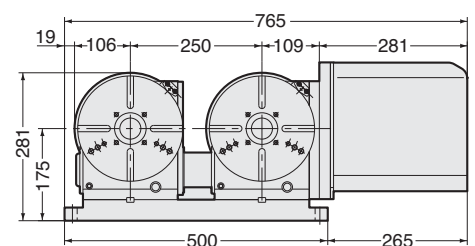
Air purge function is provided inside the motor cover as standard.

## CNC180-2W



Air purge function is provided inside the motor cover as standard.

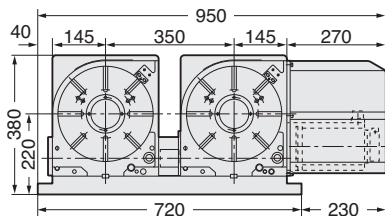
## CNC202-2W



Air purge function is provided inside the motor cover as standard.

## CNC260-2W

Pneumatic Brake  
Torque UP 588Nm



CNC202-2W-L



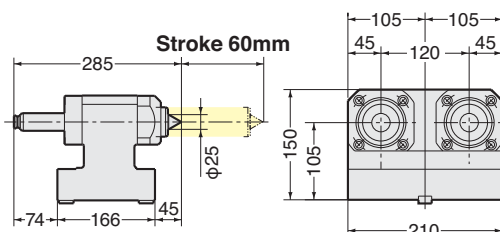
For the rotary table with pneumatic brake, air purge function is provided inside the motor cover as standard.

## Accuracy Standard of Multi-Spindle

No.	Measuring Item	Measuring Method	Accuracy
1	Pitch between Spindles		Within $\pm 0.02$ mm from nominal pitch
2	Centre Height of Spindle		Within $\pm 0.02$ mm

## Pneumatic Tailstock for Multi-Spindle

### PB-105-2W,-3W,-4W



PB-105-4W

### PB-105-2W

- ★ MT (Morse Taper) type quill is also available. Please contact us.
- ★ The stroke 60mm can be changed. Please contact us.

- ★ For fitting metal and stepped guide piece, refer [P.22](#)
- ★ For scroll chuck, tailstock and other optional accessories, refer [P.49,50](#)
- ★  $\alpha$  series attachment can be attached for CNC100-2W, 3W, 4W, CNC180-2W and CNC202-2W, refer [P.46](#)

# MANUAL TILTING ROTARY TABLE

- Table can be tilted at 0°~90° manually.
- Indexing is CNC controlled so that it can be adapted to all kinds of machining.







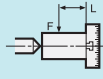
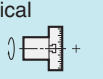

NST300

## ● Explanation of the Code No. (Example)

### NST 300 L F A - M

- No Letter: without motor
- M: with motor
- No Letter: DC servo motor
- A: AC servo motor
- Motor Maker  $\Rightarrow$  P.37
- A21: with NIKKEN  $\alpha$ 21 controller
- F:FANUC M:MELDAS Y:YASNAC OSP:OSP
- T:TOSNUC N:NEC S:SANYO Z:SIEMENS
- I:INDRAMAT H:HEIDENHAIN X:ISOFLX
- SEM:SEM B:BOSCH
- Position of motor
- No Letter: Right hand mounted motor
- L: Left hand mounted motor (Only NST300)
- Diameter of Table
- 250, 300, 500
- NST: Manual tilting table

## ■ Specifications

Item / Code No.		NST250	NST300	NST500
Diameter of Table	$\phi$ mm	250	300	500
Diameter of Spindle Hole	$\phi$ mm	$\phi 60_{H7} \phi 52$	$\phi 60_{H7} \phi 60$	$\phi 75_{H7} \phi 61.5$
Centre Height	mm	155	208	288
Width of T Slot	mm	$12^{+0.018}_0$	$12^{+0.018}_0$	$14^{+0.018}_0$
Clamping System		Air	Air	Air
Clamping Torque	N·m	147	196	196
Table Inertia at Motor Shaft ( $\frac{GD^2}{4}$ )	$\text{kg}\cdot\text{m}^2 \times 10^{-3}$	0.39	0.59	0.69
Servo Motor	$\text{min}^{-1}$	$\alpha$ iF2 / 5000 · 2000	$\alpha$ iF4 / 5000 · 2000	$\alpha$ iF8 / 4000 · 2000
MIN. Increment		0.001°	0.001°	0.001°
Rotation Speed	$\text{min}^{-1}$	16.6	11.1	5.5
Total Reduction Ratio		1/120	1/180	1/360
Indexing Accuracy	sec	20	20	20
Net Weight	kg	75	135	320
MAX. Work Load on the Table	Vertical  kg	50	100	200
	Horizontal  kg	100	300	500
MAX. Thrust Load applicable on the Table	 N	17500	31860	75000
	*1  F x L N·m	603	903	2884
	 F x L N·m	770	2010	8330
MAX. Work Inertia	Vertical  + ( $\frac{GD^2}{4}$ ) $\text{kg}\cdot\text{m}^2$	1.35	3.37	14.70
Driving Torque	 N·m	144	288	1152

★ \*1 This is the strength of the worm wheel without brake. It is applied against dynamic cutting thrust.

★ L type (Motor is mounted at left hand side) is available for NST300.

★  $\alpha$ iF8/4000 motor can be mounted on NST300.

# NST250, 300, 500



External dimensions will be different according to the type of the servo motors. Dimensions with FANUC motor or with NIKKEN  $\alpha$ 21 controller ( $\alpha$ 21 : ) are shown. Please contact with us for CAD data (2D:DXF, 3D:PARASOLID).

## NST250

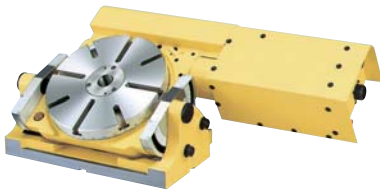
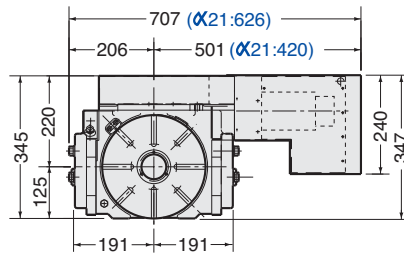
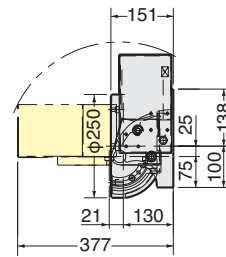


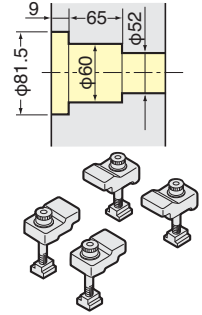
Photo shows with centre socket (option).



Guide key width: 18mm  
Table height in horizontal position: 151mm



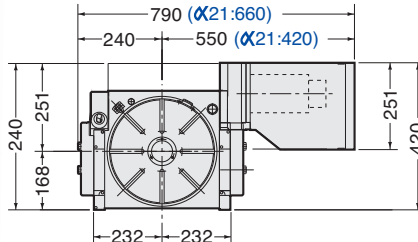
Centre height at 90° : 155mm



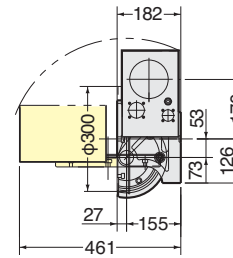
## NST300



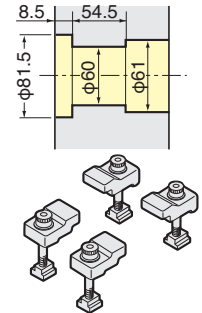
Photo shows with centre socket (option).



Guide key width: 18mm  
Table height in horizontal position: 182mm



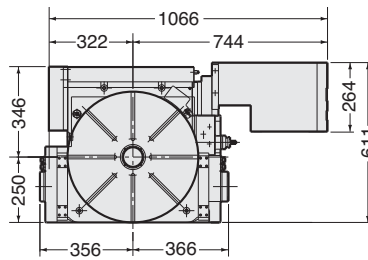
Centre height at 90° : 208mm



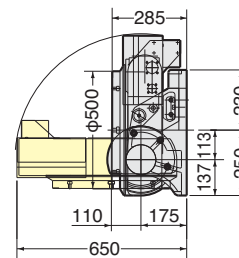
## NST500



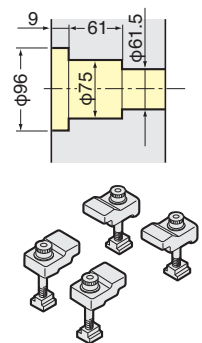
Photo shows with centre socket (option).



Guide key width: 20mm  
Table height in horizontal position: 285mm



Centre height at 90° : 288mm



★ For accuracy standard, refer P.51, 52

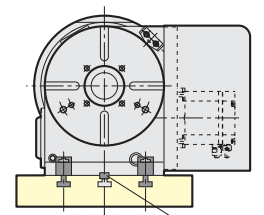
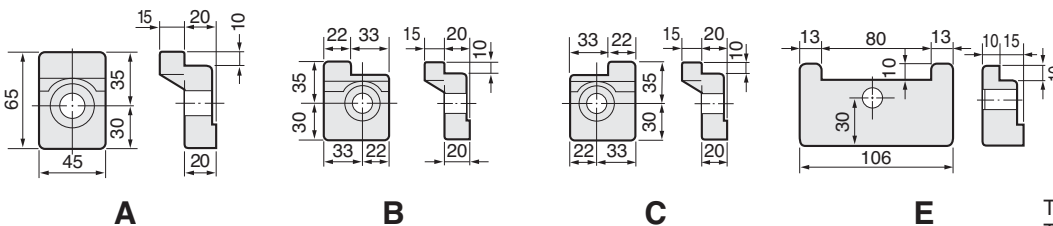
★ For scroll chuck, tailstock and other optional accessories, refer P.49,50

★  $\alpha$  series attachment can be attached for NST250, refer P.46

# FITTING METAL and STEPPED GUIDE PIECE



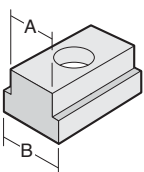
## Fitting Metal



T-slot pitch guide piece

The Fitting Metal is designed for T-slot pitches of 100mm or 125mm on the M/C table. Please contact with us for the other pitches.

## Stepped Guide Piece

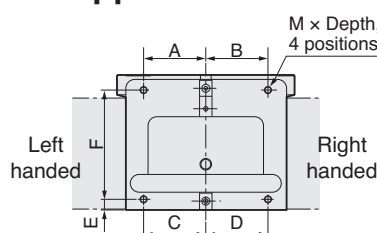


★ 2 pcs./set

● Be careful that in case of stepped guide piece is being applied, fitting metal should be changed.

B	A	14	18	20
10	W-14I			
12	W-14H	W-18E		
14		W-18A		
16	W-14A	W-18B	W-20A	
18	W-14B		W-20B	
20	W-14C	W-18C		
22		W-18D	W-20C	
24			W-20D	
7/16"	W-14F			
11/16"	W-14G			

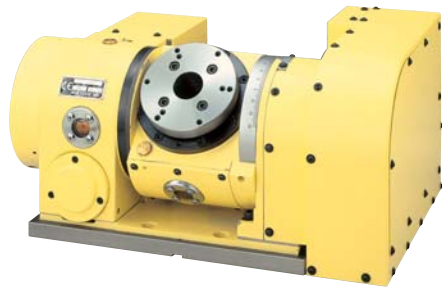
## Tapped Holes Location on the Base Plane



● Please refer above dimensions for direct mounting with the bolts from base plane side.

Code No.	A	B	C	D	E	F	M x Depth, 4 positions
CNC105, 105L	55	55	55	55	10	125	M10x12L, 4 positions
CNC180, 202 CNC180L, 202L	70	70	70	70	12	123	M 8x10L, 4 positions
CNC260, 302	105	120	105	120	12.5	167.5	M12x16L, 4 positions
CNC260L, 302L	120	105	120	105	12.5	167.5	M12x16L, 4 positions
CNC321, 401	145	135	165	135	15	200	M12x20L, 4 positions
CNC321L, 401L	135	145	135	165	15	200	M12x20L, 4 positions
CNC501, 501L	240	240	240	240	20	235	M16x30L, 4 positions

# COMPACT TILTING ROTARY TABLE



5AX-130FA

- Rotary and tilting axes are controlled by CNC.
- Rotary axis cables and hoses stay during tilting for 5AX-130 and 5AX-201 as standard.
- Various kinds of attachments [P.48](#)



## Explanation of the Code No. (Example)

### 5AX - 130 F A - M

- No Letter: without motor M: with motor
  - No Letter: DC servo motor A: AC servo motor
- Motor Maker [P.37](#)
  - WA21: with NIKKEN  $\alpha$ 21 controllers for both axes
  - DA21: with NIKKEN  $\alpha$ 21 controller for tilting axis
  - F:FANUC M:MELDAS Y:YASNAC OSP:OSP T:TOSNUC N:NEC S:SANYO
  - Z:SIEMENS I:INDRAMAT H:HEIDENHAIN X:ISOFLEX SEM:SEM B:BOSCH
- Diameter of Table 130, 200
- Location of the motor for tilting axis
  - No letter: horizontal
  - A: Back side of tilting axis B: Back side of rotary axis
  - T: Top side motor
- 5AX-: Tilting rotary CNC table

Rotary table with  $\alpha$ 21 controller, refer [P.71](#)

## Specifications

Item / Code No.		5AX-130		5AX-201	
Diameter of Table	$\phi$ mm	$\phi$ 105(with $\phi$ 130 sub table)		200	
Diameter of Spindle Hole	$\phi$ mm	$\phi$ 60H7 $\phi$ 30		$\phi$ 60H7 $\phi$ 50	
Centre Height (90°)	mm	150		180	
Table Height in Horizontal Position (0°)	mm	235		260	
Width of T Slot	mm	$\phi$ 10H7 Pin hole		$12^{+0.018}_0$	
Axis		Rotary	Tilting (0°~105°)	Rotary	Tilting (0°~105°)
Clamping System		Air	Air	(Air*) / Hyd.	(Air*) / Hyd.
Clamping Torque	N·m	205	303	(303*) / 588	(303*) / 612
Table Inertia at Motor Shaft ( $\frac{GD^2}{4}$ )	$\text{kg}\cdot\text{m}^2 \times 10^{-3}$	0.09	0.12	0.11	0.16
Servo Motor	$\text{min}^{-1}$	$\alpha$ If2 / 5000·2000	$\alpha$ If2 / 5000·2000	$\alpha$ If2 / 5000·2000	$\alpha$ iS4 / 5000·2000
MIN. Increment		0.001°	0.001°	0.001°	0.001°
Rotation Speed	$\text{min}^{-1}$	22.2	11.1	22.2	16.6
Total Reduction Ratio		1/90	1/180	1/90	1/120
Indexing Accuracy	sec	$\pm 30$	60	20	60
Net Weight	kg	115		160	
MAX. Work Load on the Table	0° to 30°	50		60	
	30° to 90°	25		40	
MAX. Thrust Load applicable on the Table	Tilting Angle = 0°	5880		9800	
	Tilting Angle = 0°	L = 65mm	F = 2940N	L = 100mm	F = 4900N
	Tilting Angle = 90°	L <sub>1</sub> = 0mm	F <sub>1</sub> = 3460N	L <sub>1</sub> = 0mm	F <sub>1</sub> = 5880N
		L <sub>2</sub> = 100mm	F <sub>2</sub> = 1590N	L <sub>2</sub> = 100mm	F <sub>2</sub> = 2940N
Tilting Angle = 90°	98		382		
MAX. Work Inertia	$\text{kg}\cdot\text{m}^2$	0.12		0.5	
Driving Torque	N·m	72		72	

★ AWC system is available for all rotary tables, please refer [P.47~48](#)

★ Rotary joint is available for all rotary tables, please refer [P.54](#)

★ Ultra precision type is available for all rotary tables.  
Rotary axis:  $\pm 5''$  Tilting axis:  $\pm 10''$ , please refer [P.53](#)

★ Location of tilting axis motor can be changed as an option. e.g. 5AX-B130.

★ The air-hydraulic booster is available, when 5AX-201 with hydraulic clamping system is used on the M/C without hydraulic source, please refer [P.55](#).



# 5AX-130, 5AX-201



External dimensions will be different according to the type of the servo motors. Dimensions with FANUC motor or with NIKKEN  $\alpha$ 21 controller ( $\alpha$ 21 : ) are shown. Please contact with us for CAD data (2D:DXF, 3D:PARASOLID).

## 5AX-130

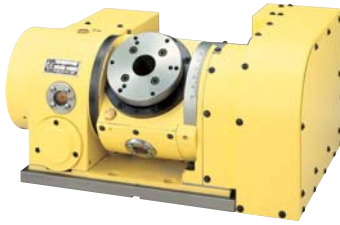
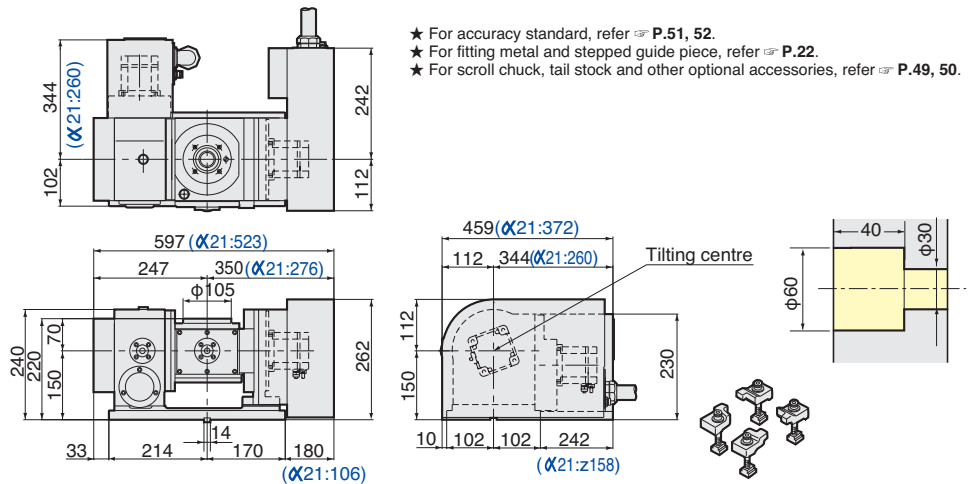
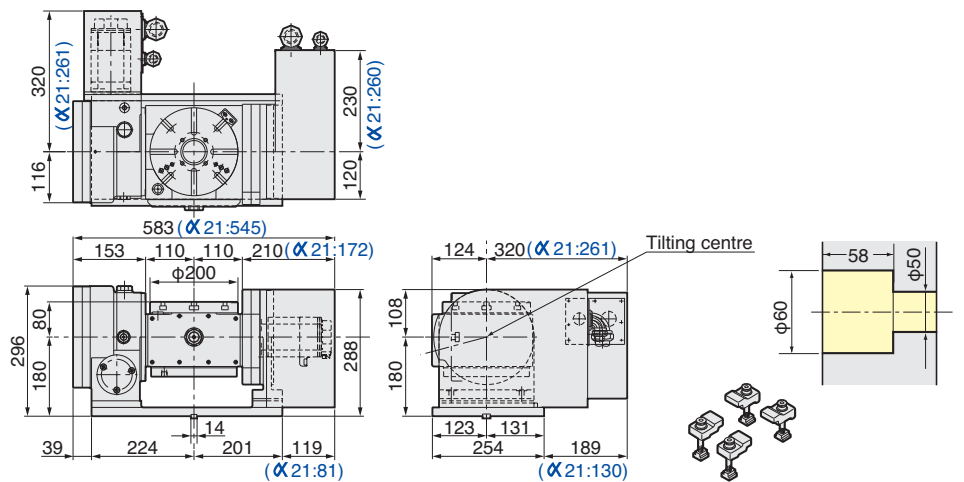


Photo shows with  $\phi$ 130mm plate.



Centre height of high column table is 65mm higher than that of standard table, refer  $\Rightarrow$  P.45

## 5AX-201 NEW



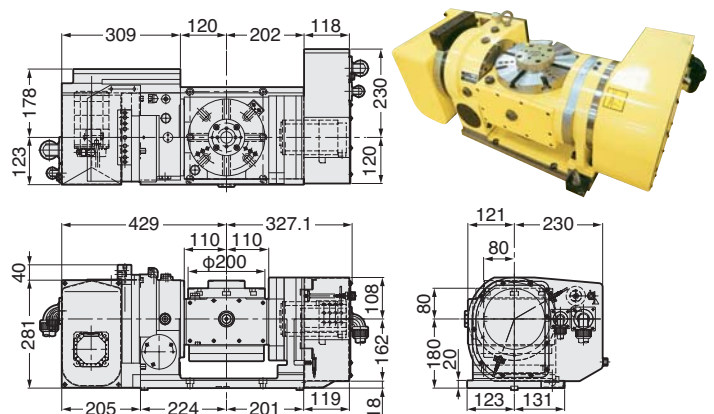
Built-in type 4 ports rotary joint can be attached on standard type as an option. (High column type is not necessary.)

### The Area of Noninterference in Tilting Position.

Angle	5AX-130	5AX-201
0° }		
45°		
0° }		
90°		
0° }		
105°		

### 5AX-201BAFA

The tilting axis motor is mounted at back side.



### Calculation Method of Drilling Thrust Load

$$T = 9.8 \times (0.711 \times HB \times f^{0.8} \times D^{0.8} + 0.0022 \times HB \times D^2)$$

T: Thrust load (N)

f: Feed per one revolution (mm/rev)

HB: Brinell hardness of the work piece

D: Diameter of drill (mm)

For example, in case of drilling an aluminium

(HB:100, D:  $\phi$ 9.5mm, F: 0.2mm/rev),

the calculation method is as follows.

$$9.8 \times (0.711 \times 100 \times 0.2^{0.8} \times 9.5^{0.8} + 0.0022 \times 100 \times 9.5^2) = 1359N$$

This is the thrust load of new drill. When the drill wore, thrust load will increase. (140~160%)

# TILTING ROTARY TABLE



5AX-230



Powerful Brake System

■ CNC tilting rotary table with powerful brake system.

USA, EU : PAT

● Explanation of the Code No. (Example)

**5AX- 230 L F A - M**

- No Letter: without motor
- M: with motor
- No Letter: DC servo motor
- A: AC servo motor
- Motor Maker ⇨ P.37
- WA21PW: with NIKKEN  $\alpha$ 21 controllers for both axes
- DA21PW: with NIKKEN  $\alpha$ 21 controller for tilting axis
- F:FANUC M:MELDAS Y:YASNAC OSP:OSP
- T:TOSNUC N:NEC S:SANYO Z:SIEMENS
- I:INDRAMAT H:HEIDENHAIN X:ISOFLEX
- SEM:SEM B:BOSCH
- Position of rotary axis motor
- No Letter: Right hand mounted motor
- L: Left hand mounted motor
- Diameter of Table 200, 230, 250
- Location of the motor for tilting axis
- No letter: horizontal
- T: Top side motor
- 5AX-: Tilting rotary CNC table

## Specifications

Item / Code No.		5AX-230		5AX-250	
Diameter of Table	$\phi$ mm	230		250	
Diameter of Spindle Hole	$\phi$ mm	$\phi 60H7 \phi 40$		$\phi 60H7 \phi 50$	
Centre Height (90°)	mm	240		250	
Table Height in Horizontal Position (0°)	mm	285		250	
Width of T Slot	mm	$12^{+0.018}_0$		$12^{+0.018}_0$	
Axis		Rotary	Tilting (0°~105°)	Rotary	Tilting (0°~105°)
Clamping System	3.5MPa	Hyd.	Hyd.	Hyd.	Hyd.
Clamping Torque	N·m	490	3430	588	4900
Table Inertia at Motor Shaft ( $\frac{GD^2}{4}$ )	$\text{kg}\cdot\text{m}^2 \times 10^{-3}$	0.3	0.5	0.11	0.16
Servo Motor	$\text{min}^{-1}$	$\alpha$ iF4 / 5000·2000	$\alpha$ iF8 / 4000·2000	$\alpha$ iF4 / 5000·2000	$\alpha$ iF4 / 5000·2000
MIN. Increment		0.001°	0.001°	0.001°	0.001°
Rotation Speed	$\text{min}^{-1}$	11.1	5.5	22.2	11.1
Total Reduction Ratio		1/180	1/360	1/90	1/180
Indexing Accuracy	sec	20	60	20	60
Net Weight	kg	220		290	
MAX. Work Load on the Table	0° to 30°	100		80	
	30° to 90°	100		50	
MAX. Thrust Load applicable on the Table	Tilting Angle = 0°	11760		9800	
	Tilting Angle = 0°	L=115mm	F=5880N	L=100mm	F=4900N
	Tilting Angle = 90°	L <sub>1</sub> =0mm L <sub>2</sub> =100mm	F <sub>1</sub> =5880N F <sub>2</sub> =2940N	L <sub>1</sub> =0mm L <sub>2</sub> =100mm	F <sub>1</sub> =5880N F <sub>2</sub> =2940N
	Tilting Angle = 90°	451		382	
MAX. Work Inertia	$\frac{GD^2}{4}$ $\text{kg}\cdot\text{m}^2$	0.66		0.5	
Driving Torque		288		144	

★ L type (Motor is mounted at left hand side) is available for 5AX-230.  
 ★ \*Please specify 5AX-2002 as the Code No. of 5AX-200II when ordering.  
 ★ Range of tilting angle (0°~105°) can be expanded as an option. Please contact us.  
 ★ AWC system is available for all rotary tables, please refer ⇨ P.47~48  
 ★ Rotary joint is available for all rotary tables, please refer ⇨ P.54  
 ★ Ultra precision type is available for all rotary tables, Rotary axis:  $\pm 5''$  Tilting axis:  $\pm 10''$ , please refer ⇨ P.53

★  $\alpha$ iF8/4000 motor can be mounted on the rotary axis of 5AX-230.  
 ★ The supplied hydraulic pressure is 3.5MPa for hydraulic clamping system.  
 ★ The air-hydraulic booster is available, when 5AX-2002 with hydraulic clamping system is used on the M/C without hydraulic source, please refer ⇨ P.55.  
 ★ The air-hydraulic booster can not be used for 5AX-230.  
 The hydraulic tank is always necessary for 5AX-230.

# 5AX-230, 5AX-250

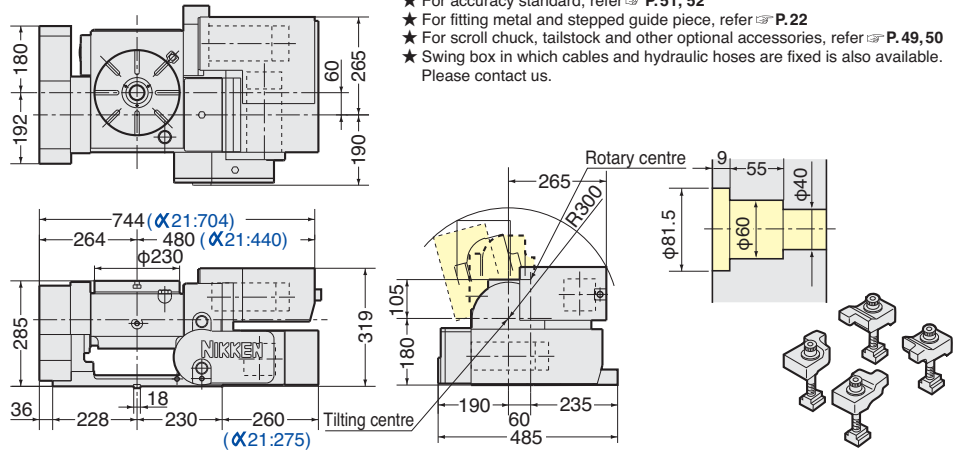


External dimensions will be different according to the type of the servo motors. Dimensions with FANUC motor or with NIKKEN  $\alpha$ 21 controller ( $\alpha$ 21 : ) are shown. Please contact with us for CAD data (2D:DXF, 3D:PARASOLID).

## 5AX-230



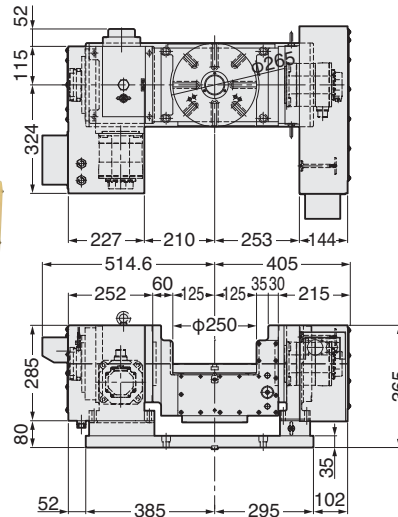
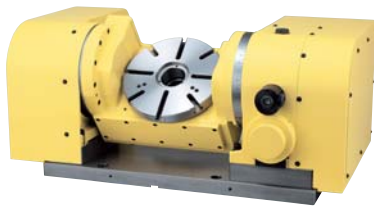
Photo shows with centre socket (option).



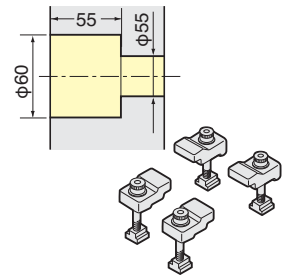
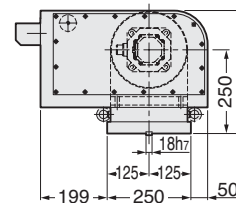
- ★ For accuracy standard, refer  $\Rightarrow$  P.51, 52
- ★ For fitting metal and stepped guide piece, refer  $\Rightarrow$  P.22
- ★ For scroll chuck, tailstock and other optional accessories, refer  $\Rightarrow$  P.49, 50
- ★ Swing box in which cables and hydraulic hoses are fixed is also available. Please contact us.

Centre height of high column table is 75mm higher than that of standard table, refer  $\Rightarrow$  P.54

## 5AX-250



Example when tilting base is supplied from M/C builder.

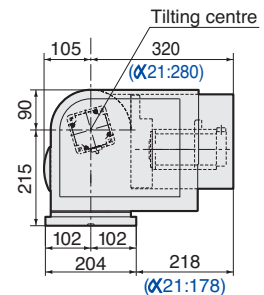
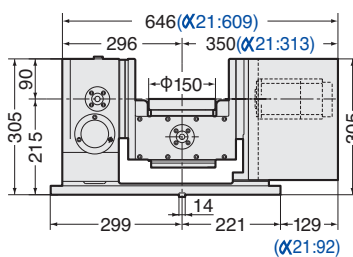
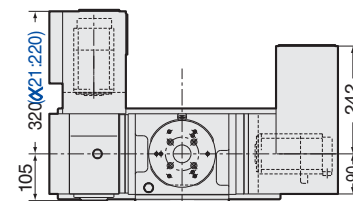


Built-in type 3 ports rotary joint can be attached on standard type as an option.

### The Area of Noninterference in Tilting Position.

Angle	5AX-230	5AX-250
0°		
45°		
90°		
105°		

## 5AX-150



### φ150mm type 5AX TILTING ROTARY TABLE

- Diameter of Table : φ150mm
- MAX. Work Load : 50kg (Horizontal) 25kg (Vertical)
- MAX. Rotation Speed : 22.2min<sup>-1</sup> (Rotary), 11.1min<sup>-1</sup> (Tilting)
- Indexing Accuracy : ±30sec. (Rotary), 60sec. (Tilting)
- Brake torque : 205Nm (Rotary), 303Nm (Tilting)
- Net Weight : 153kg
- Servo Motor : ACQIF2 (Rotary), ACQIF4 (Tilting)
- Spindle Hole : φ40mm H7×φ30mm Through Hole
- Tilting Angle : 0°~105°

# TILTING ROTARY TABLE

**NIKKEN**

■ CNC tilting rotary table with powerful clamping system



5AX-350

● Explanation of the Code No. (Example)

**5AX - 350 F A - M**

- No Letter: without motor M: with motor
- No Letter: DC servo motor A: AC servo motor
- Motor Maker P.37
- WA21PW: with NIKKEN  $\alpha$ 21 controllers for both axes
- DA21PW: with NIKKEN  $\alpha$ 21 controller for tilting axis
- F:FANUC M:MELDAS Y:YASNAC OSP:OSP T:TOSNUC
- N:NEC S:SANYO Z:SIEMENS I:INDRAMAT H:HEIDENHAIN
- X:ISOFLEX SEM:SEM B:BOSCH
- Diameter of Table 350, 550
- 5AX-: Tilting rotary CNC table

## Specifications

Item / Code No.		5AX-350		5AX-550	
Diameter of Table	$\phi$ mm	350		550	
Diameter of Spindle Hole	$\phi$ mm	$\phi$ 80H7		$\phi$ 130H7	
Centre Height (90°)	mm	300		380	
Table Height in Horizontal Position (0°)	mm	300		518	
Width of T Slot	mm	12 <sup>+0.018</sup> <sub>0</sub>		14 <sup>+0.018</sup> <sub>0</sub>	
Axis		Rotary	Tilting (0°~105°)	Rotary	Tilting (-105°~+105°)
Clamping System	3.5MPa	Hyd.	Hyd.	Hyd.	Hyd.
Clamping Torque	N·m	1568	1568	3430	6272
Table Inertia at Motor Shaft	( $\frac{GD^2}{4}$ ) kg·m <sup>2</sup> ×10 <sup>-3</sup>	0.8	1.35	5.5	5.2
Servo Motor	min <sup>-1</sup>	$\alpha$ iF8 / 4000·2000	$\alpha$ iF12 / 4000·2000	$\alpha$ iF12 / 4000·2000	$\alpha$ iF12 / 4000·2000
MIN. Increment		0.001°	0.001°	0.001°	0.001°
Rotation Speed	min <sup>-1</sup>	22.2	22.2	11.1	5.5
Total Reduction Ratio		1/90	1/90	1/180	1/360
Indexing Accuracy	sec	20	60	20	60
Net Weight	kg	420 (without Base:355)		1150	
MAX. Work Load on the Table	0° to 30°	200		500	
	30° to 90°	200		300	
MAX. Thrust Load applicable on the Table	Tilting Angle = 0°	19600		31360	
	Tilting Angle = 0°	L=175mm	F=4900N	L=275mm	F=9800N
	Tilting Angle = 90°	L <sub>1</sub> =0mm	F <sub>1</sub> =17160N	L <sub>1</sub> =0mm	F <sub>1</sub> =19600N
		L <sub>2</sub> =100mm	F <sub>2</sub> =8580N	L <sub>2</sub> =200mm	F <sub>2</sub> =14120N
	Tilting Angle = 90°	858		2548	
MAX. Work Inertia		3.2		23	
Driving Torque		288		864	

★ Range of tilting angle (0°~105°) can be expanded as an option. Please contact us.  
 ★ AWC system is available for all rotary tables, please refer P.47~48  
 ★ Rotary joint is available for all rotary tables, please refer P.55

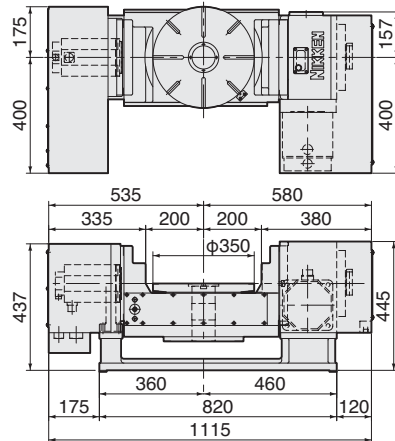
★ Ultra precision type is available for all rotary tables, Rotary axis:  $\pm 5''$  Tilting axis:  $\pm 10''$ , please refer P.53  
 ★ The supplied hydraulic pressure is 3.5MPa for hydraulic clamping system.

# 5AX-350, 5AX-550



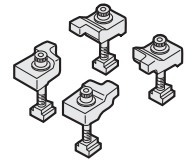
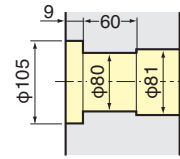
External dimensions will be different according to the type of the servo motors. Dimensions with FANUC motor are shown. Please contact with us for CAD data (2D:DXF, 3D:PARASOLID).

## 5AX-350



- ★ For accuracy standard refer P.51, 52
- ★ For fitting metal and stepped guide piece, refer P.22
- ★ For scroll chuck, tailstock and other optional accessories, refer P.49, 50

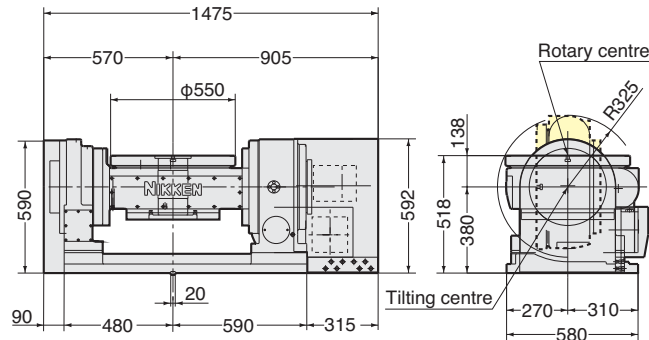
Tilting centre



Built-in type 6 ports rotary joint can be attached on standard type as an option. (High column type is not necessary.)

## 5AX-550

### Powerful double clamping system on both ends of tilting axis



Rotary centre

R325

Tilting centre

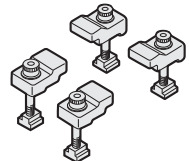
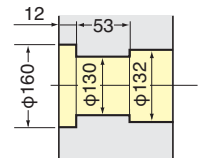


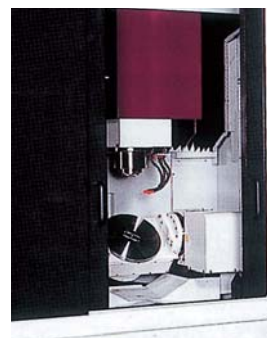
Photo shows with centre socket (option).

Built-in type 4 ports rotary joint can be attached on standard type as an option. (High column type is not necessary.)

### The Area of Noninterference in Tilting Position.

Angle	5AX-350	5AX-550
0°		
45°		
90°		
105°		

Built-in type 5AX rotary tables are more and more getting popular as a component of M/C, even for the special applications.



Utilization for 4th and 5th axis rotary table of the M/C for die moulding

Utilization for 4th and 5th axis rotary table of special grinding centre



Ball Bar System



R-Test System

Accuracy of Speeds and Interpolations for 5AX- Table ISO10791-6

# LARGE TILTING ROTARY TABLE

**NEW**

**NIKKEN**



5AX-1200B









- CNC tilting rotary table with powerful clamping system at both side.
- Counter balance weight can be attached on 5AX-1200A to compensate the unbalancing load as standard.

● Explanation of the Code No. (Example)

**5AX - 1200 A F A - M**

- No Letter: without motor M: with motor
- No Letter: DC servo motor A: AC servo motor
- Motor Maker  $\square$  P.37
  - WA21: with NIKKEN  $\alpha$ 21 controllers for both axes
  - DA21: with NIKKEN  $\alpha$ 21 controllers for tilting axis
  - F:FANUC M:MELDAS Y:YASNAC OSP:OSP3
  - T:TOSNUC Z:SIEMENS
- Location of Tilting Axis Centre
  - A: Centre of Rotary Axis Body, B: Top Surface of Rotary Axis
- Diameter of Table
  - 800, 1200
- 5AX-: Tilting rotary CNC table

## Specifications The specification will be varied according to your application. Please contact us.

Item / Code No.		5AX-800		5AX-1200	
Diameter of Table	$\phi$ mm	800×500		1200	
Diameter of Spindle Hole	$\phi$ mm	$\phi$ 130		$\phi$ 300H7	
Centre Height (90°)	mm	550		750	
Table Height in Horizontal Position (0°)	mm	500		950	
Width of T Slot	mm	$-(14^{+0.018}_0)^{*1}$		$22^{+0.018}_0^*1$	
Axis		Rotary	Tilting	Rotary	Tilting (-20°~105°)
Clamping System	3.5MPa	Hyd.	Hyd.	Hyd.	Hyd.
Clamping Torque	N·m	4655	6125	14700	19600
Table Inertia at Motor Shaft $(\frac{GD^2}{4})$	$\text{kg}\cdot\text{m}^2 \times 10^{-3}$	6.8	6.0	10.8	3.5
Servo Motor	$\text{min}^{-1}$	$\alpha$ iF22 / 4000·2000	$\alpha$ iF40 / 3000·2000	$\alpha$ iF22 / 4000·2000	$\alpha$ iF22 / 4000·2000
MIN. Increment		0.001°	0.001°	0.001°	0.001°
Rotation Speed	$\text{min}^{-1}$	25	12.5	5.5	2.7
Total Reduction Ratio		1/60	1/120	1/360	1/720
Indexing Accuracy	sec	20	60	20	60
Indexing Accuracy of Ultra Precision <sup>*2</sup>	sec	±5	±10	±5	±10
Net Weight	kg	2300		7300	
MAX. Work Load on the Table	0° to 30° 	500 kg		2500 kg	
	30° to 90° 	500 kg		1500 kg	
MAX. Thrust Load applicable on the Table	Tilting Angle = 0° 	31360 N		137200 N	
	Tilting Angle = 0° 	2695 N		5488 N	
	Tilting Angle = 90° 	2824 N		9600 N	
	Tilting Angle = 90° 	2548 N·m		14700 N·m	
MAX. Work Inertia	 $(\frac{GD^2}{4})$	23 $\text{kg}\cdot\text{m}^2$		276 $\text{kg}\cdot\text{m}^2$	
Driving Torque		422 N·m		3168 N·m	

★ Range of tilting angle (0°~105°) can be expanded as an option. Please contact us. ★ Rotary joint is available for all rotary tables, please refer  $\square$  P.54  
 ★ \*1 Standard large rotary tables are without T slot. T slot is available as an option, please specify the width of the T slot.  
 ★ \*2 Ultra precision type is available for all rotary tables, Rotary axis: ±5" Tilting axis: ±10", please refer  $\square$  P.53  
 ★ The supplied hydraulic pressure is 3.5MPa for hydraulic clamping system.

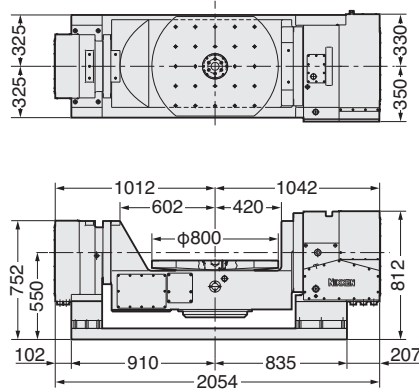
# 5AX-800, 5AX-1200



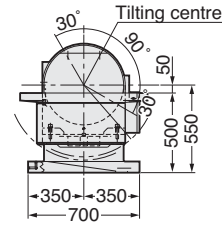
External dimensions will be different according to the type of the servo motors. Dimensions with FANUC motor are shown. Please contact with us for CAD data (2D:DXF, 3D:PARASOLID).

## 5AX-800 **NEW**

**Powerful double clamping system on both ends of tilting axis.**

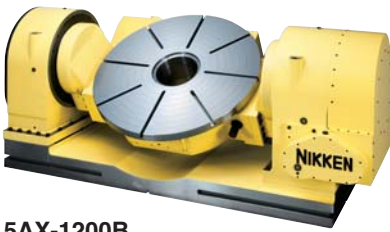


- ★ For accuracy standard refer [P.51, 52](#)
- ★ For fitting metal and stepped guide piece, refer [P.22](#)
- ★ For scroll chuck, tailstock and other optional accessories, refer [P.49, 50](#)

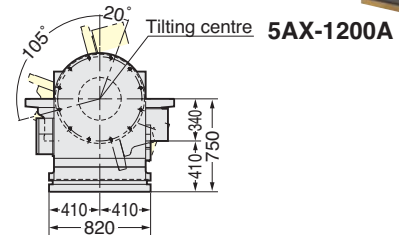
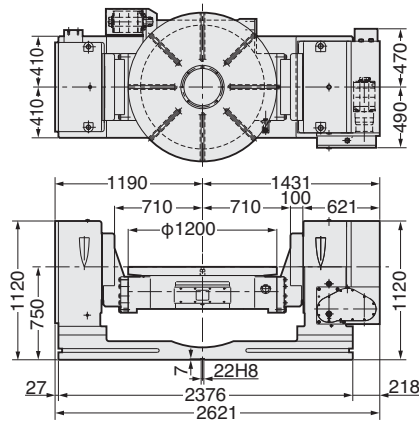


## 5AX-1200 **NEW**

**Powerful double clamping system on both ends of tilting axis**



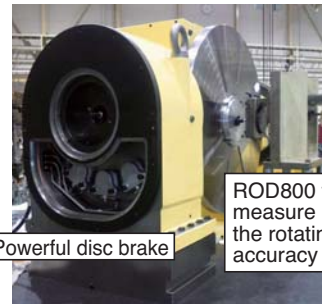
5AX-1200B



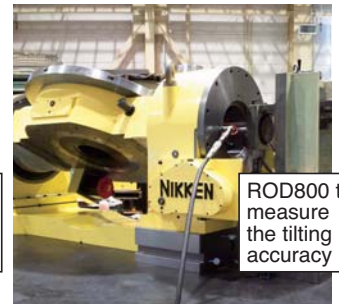
### ■ The Area of Noninterference in Tilting Position.

Angle	5AX-800	5AX-1200
0°		
45°		
90°		
120°		

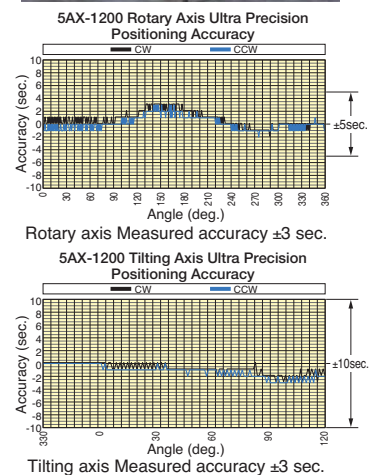
Counter balance weight can be attached on 5AX-1200A to compensate the unbalancing load as standard.



ROD800 to measure the rotating accuracy



ROD800 to measure the tilting accuracy



# MULTI-SPINDLE TILTING ROTARY TABLE



5AX-4MT-120

- Tilting rotary table with Multi-Spindle
- Various attachment for fixing work piece



- Explanation of the Code No. (Example)

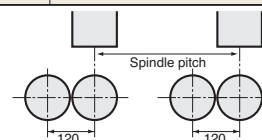
**5AX - 2MT - 105 - 120 F A - M**

- 5AX -: Tilting rotary table
- Number of spindles 2, 3, 4
- Diameter of Table 105, 120
- Pitch (Centre distance)
- No Letter: Tilting axis right hand side
- L: Tilting axis left hand side
- No Letter: without motor M: with motor
- No Letter: DC servo motor A: AC servo motor
- Motor Maker P.37
- WA21: with NIKKEN  $\alpha$ 21 controllers for both axes
- DA21: with NIKKEN  $\alpha$ 21 controller for tilting axis
- F:FANUC M:MELDAS
- Y:YASNAC OSP:OSP T:TOSNUC N:NEC
- S:SANYO Z:SIEMENS I:INDRAMAT
- H:HEIDENHAIN X:ISOFLEX SEM:SEM B:BOSCH

## Specifications

Item / Code No.		5AX-2MT-105		5AX-4MT-120	
Diameter of Table	$\phi$ mm	105		105	
Diameter of Spindle Hole	$\phi$ mm	$\phi 60_{H7} \phi 30$		$\phi 60_{H7} \phi 30$	
Number of spindles (Pitch)	mm	120		120	
Centre Height (90°)	mm	175		235	
Table Height in Horizontal Position (0°)	mm	250		300	
Width of T Slot	mm	$16^{+0.018}_0$		$16^{+0.018}_0$	
Axis		Rotary	Tilting (0°~105°)	Rotary	Tilting (0°~105°)
Clamping System	Air 0.5MPa Hyd. 3.5MPa	Air	Air	Hyd.	Hyd.
Clamping Torque	N·m	147	147	147	343
Table Inertia at Motor Shaft ( $\frac{GD^2}{4}$ )	$\text{kg}\cdot\text{m}^2 \times 10^{-3}$	0.13	0.13	0.2	0.48
Servo Motor	$\text{min}^{-1}$	$\alpha$ iF2 / 5000·2000	$\alpha$ iF2 / 5000·2000	$\alpha$ iF8 / 4000·2000	$\alpha$ iF4 / 5000·2000
MIN. Increment		0.001°	0.001°	0.001°	0.001°
Rotation Speed	$\text{min}^{-1}$	22.2	11.1	11.1(44.4)	16.6
Total Reduction Ratio		1/90	1/180	1/180(1/45)	1/120
Indexing Accuracy	sec	$\pm 30$	60	$\pm 45$	$\pm 30$
Net Weight	kg	150		350	
MAX. Work Load on the Table	0° to 30°	15 kg		25 kg	
	30° to 90°	10 kg		15 kg	
MAX. Thrust Load applicable on the Table	Tilting Angle = 0°	3920 N		3920 N	
	Tilting Angle = 0°	L=60mm	F <sub>1</sub> =784N	L=60mm	F=2858 N
	Tilting Angle = 90°	L <sub>1</sub> =0mm L <sub>2</sub> =100mm	F <sub>1</sub> =653N F <sub>2</sub> =490N	L <sub>1</sub> =0mm L <sub>2</sub> =100mm	F <sub>1</sub> =1380N F <sub>2</sub> =1040N
	Tilting Angle = 90°	49 N·m		49 N·m	
MAX. Work Inertia	$\frac{GD^2}{4}$ $\text{kg}\cdot\text{m}^2$	0.014		0.021	
Driving Torque	N·m	36		144	

- ★ Min. pitch between spindles 105:120mm. If you need different pitch, please contact us.
- ★ 4 spindle rotary table to suit 2 Spindle M/C is also available, please contact with us.
- ★ Max numbers of spindles 105:4 spindles.
- ★ The supplied hydraulic pressure is 3.5MPa for hydraulic clamping system.



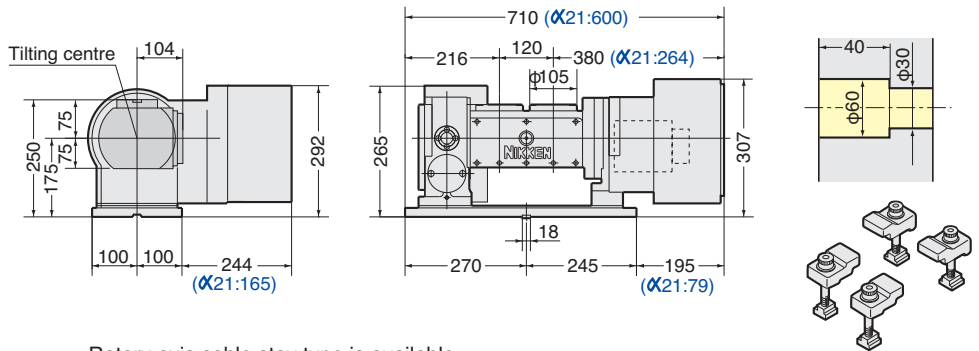
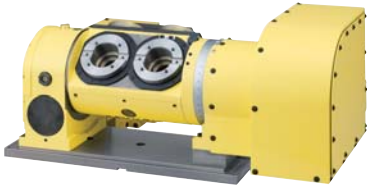


# 5AX-2MT, 5AX-4MT



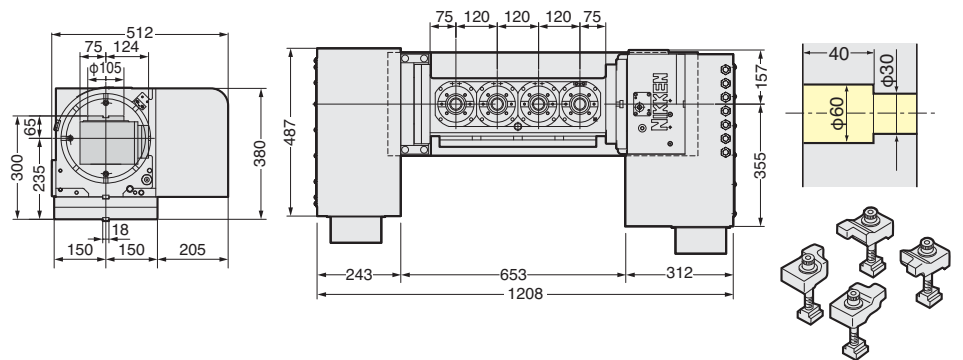
External dimensions will be different according to the type of the servo motors. Dimensions with FANUC motor or with NIKKEN  $\alpha$ 21 controller ( $\alpha$ 21 : ) are shown. Please contact with us for CAD data (2D:DXF, 3D:PARASOLID).

## 5AX-2MT-105



Rotary axis cable stay type is available.  
Centre height of high column table is 35mm higher than that of standard table.  
MAX. number of ports in rotary joint Standard: 4 ports, High Column: 6 ports

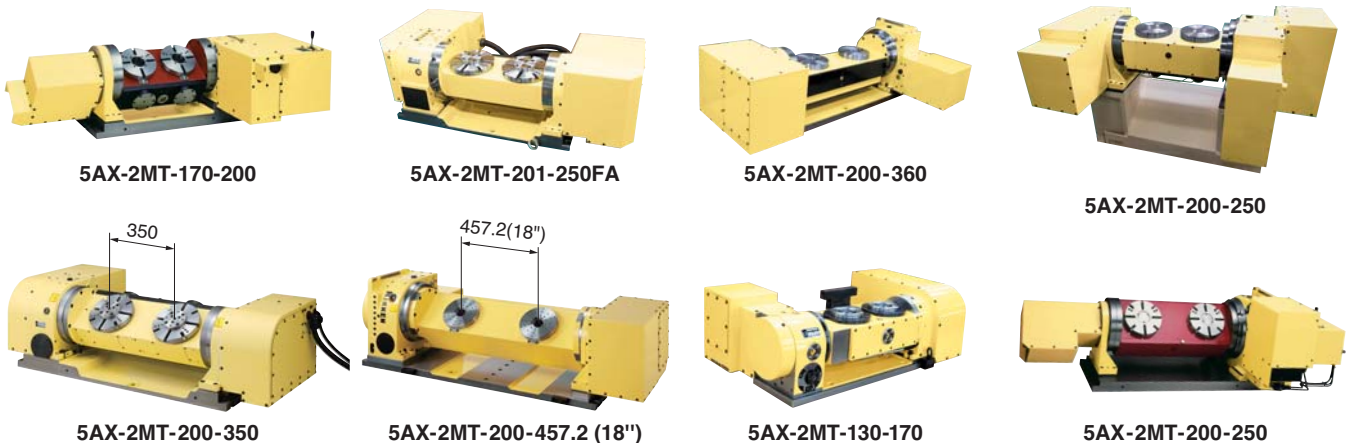
## 5AX-4MT-120



MAX. 6 port rotary joint can be attached on standard type as an option.

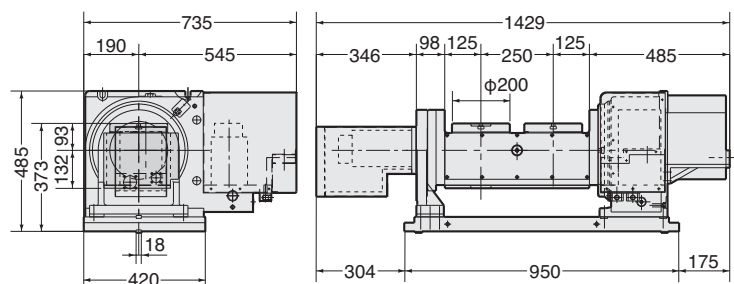
## Multi-Spindle Tilting Rotary Table

For Multi-Spindle Tilting Rotary Table, please contact us with the required faceplate diameters, fixture attachment (e.g. Power Chuck etc), the required spindle pitch, the M/C model and the type of NC.



## Accuracy Standard of Multi-Spindle

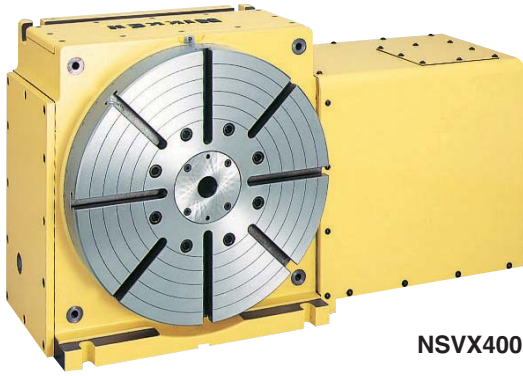
No.	Measuring Item	Measuring Method	Accuracy
1	Pitch between Spindles		Within $\pm 0.02$ mm from nominal pitch
2	Centre Height of Spindle		Within $\pm 0.02$ mm



5AX-2MT-200-250

- ★ How to mount the above tables on your M/C, please contact us.
- ★ For fitting metal of standard accessories, refer  $\Rightarrow$  P.22
- ★ For scroll chuck, tailstock and other optional accessories, refer  $\Rightarrow$  P.49, 50
- Please contact with us about the chucking or clamp system of your work piece.
- ★  $\alpha$ series attachment can be used for 5AX-2MT-105 and 5AX-4MT-105, refer  $\Rightarrow$  P.46

# ROTARY HIRTH COUPLING INDEX



NSVX400

INDEXING ACCURACY :  $\pm 2''$

- High Rigidity
  - Indexing Accuracy :  $\pm 2''$
  - No Lifting up of Table at Indexing Time. (Built-in 3 pieces of Hirth Coupling)
- JAPAN : PAT.



● Explanation of the Code No. (Example)

**NSV X 400 F A - M**

- No Letter: without motor M: with motor
- No Letter: DC servo motor A: AC servo motor
- Motor Maker P.37
- A21: with NIKKEN  $\alpha$ 21 controller
- F:FANUC M:MELDAS Y:YASNAC OSP:OSP
- T:TOSNUC N:NEC S:SANYO Z:SIEMENS
- I:INDRAMAT H:HEIDENHAIN X:ISOFLEX
- SEM:SEM B:BOSCH
- No Letter: Right hand mounted motor
- L: Left hand mounted motor
- T: Top mounted
- Diameter of Table 180, 300, 400, 500
- X: Rotary and indexing table ( $1^\circ$  and  $0.001^\circ$ ) Z: Indexing table ( $1^\circ$ )
- Hirth coupling index table

## Specifications

Item / Code No.		NSVZ180	NSVZ300	NSVX400	NSVX500	NSVX400T	
Diameter of Table	$\phi$ mm	180	300	400	500	400	
Diameter of Spindle Hole	$\phi$ mm	$\phi 60_{H7} \phi 30$	$\phi 60_{H7} \phi 52$	$\phi 80_{H7}$	$\phi 80_{H7}$	$\phi 80_{H7}$	
Centre Height	mm	135	170	240	310	240	
Width of T Slot	mm	$12^{+0.018}_0$	$12^{+0.018}_0$	$14^{+0.018}_0$	$14^{+0.018}_0$	$14^{+0.018}_0$	
Clamping System	3.5MPa	Hyd.	Hyd.	Hyd.	Hyd.	Hyd.	
Clamping Torque	N·m	910	2155	5880	5880	5880	
Table Inertia at Motor Shaft ( $\frac{GD^2}{4}$ )	$\text{kg}\cdot\text{m}^2 \times 10^{-3}$	0.11	0.16	2.9	3.9	2.9	
Servo Motor	$\text{min}^{-1}$	$\alpha$ IF2/5000·2000	$\alpha$ IF2/5000·2000	$\alpha$ IF12/4000·2000	$\alpha$ IF12/4000·2000	$\alpha$ IF12/4000·2000	
MIN. Increment		$1^\circ$	$1^\circ$	$1^*/0.001^\circ$	$1^*/0.001^\circ$	$1^*/0.001^\circ$	
Rotation Speed	$\text{min}^{-1}$	11.1	11.1	22.2	16.6	16.6	
Total Reduction Ratio		1/180	1/180	1/90	1/120	1/120	
Indexing Accuracy	sec	$\pm 3$	$\pm 2$	$\pm 2^*$	$\pm 2^*$	$\pm 2^*$	
Net Weight	kg	60	150	325	410	350	
MAX. Work Load on the Table	Vertical	50	150	250	250	250	
	Horizontal	100	300	500	500	—	
MAX. Thrust Load applicable on the Table		23520	39200	58800	58800	58800	
	*1	$F \times L$ N·m	911	2156	5880	5880	5880
		$F \times L$ N·m	569	1421	3920	3920	3920
Guide Line of MAX. Unbalancing Load	*2	3.0	3.0	10.0	10.0	—	
MAX. Work Inertia	Vertical	0.14	1.0	6.4	6.4	11.5	
Driving Torque		—	—	432	576	576	

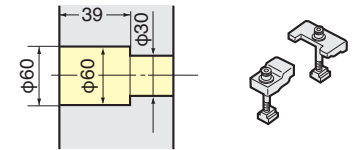
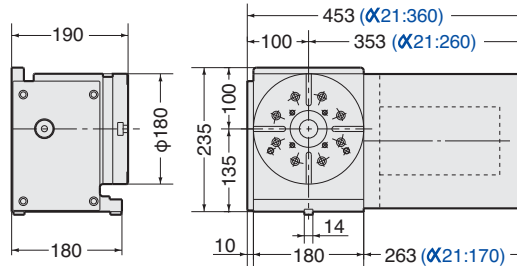
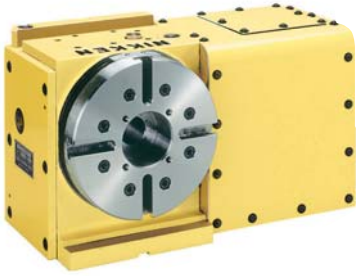
★\*1 This is the strength of the clamping by the hirth coupling.  
 ★\*2 The guide line of MAX unbalancing load means the unbalancing load, when the rotary table is used with support table in vertical application. The guide line figure will be different according to the servo motor, please refer P.37 for more detail.  
 ★ NSVZ series are indexing table which is indexable at each  $1^\circ$ .  
 ★ NSVX series are rotary and indexing table which clamped by hirth coupling (of high precision & high rigidity) at each  $1^\circ$ , also perform min. command incremental at  $0.001^\circ$  and profile milling.  
 ★ Rotary joint is available for all rotary tables, please refer P.54. ★  $\alpha$ IF4/5000 motor can be mounted on NSVZ180 and NSVZ300.  
 ★ The air-hydraulic booster is available, when NSVZ180 or NSVZ300 is used on the M/C without hydraulic source, please refer P.55.  
 ★ The supplied hydraulic pressure is 3.5MPa for hydraulic clamping system. ★ Please be careful that the centralizing of work piece or jig fixture should be done after indexing, not rotating.  
 ★ The solenoid valve is installed inside the table for the indexing table with NIKKEN controller. The solenoid valve must be installed at the hydraulic tank for the indexing table of the additional axis control.

# NSVZ180,300 NSVX400,500



External dimensions will be different according to the type of the servo motors. Dimensions with FANUC motor or with NIKKEN  $\alpha$ 21 controller ( $\alpha$ 21 : ) are shown. Please contact with us for CAD data (2D:DXF, 3D:PARASOLID).

## NSVZ180



## NSVZ300

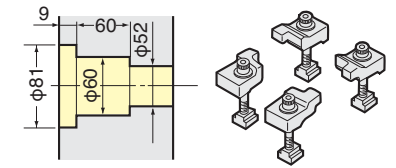
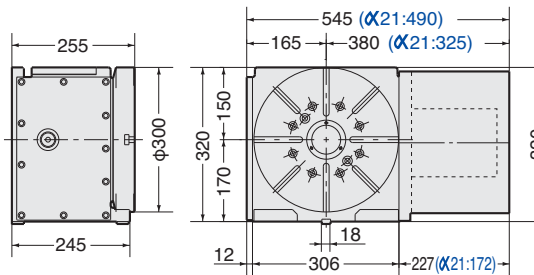


Photo shows with centre socket (option).

## NSVX400

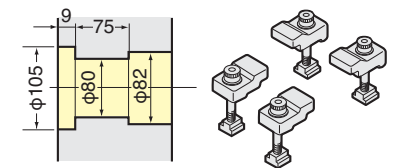
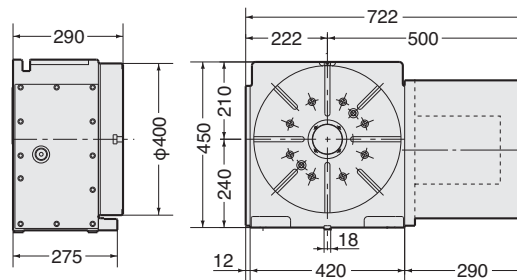
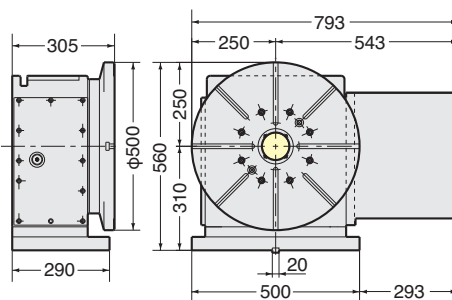
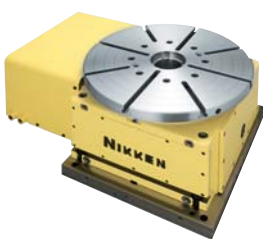


Photo shows with centre socket (option).

## NSVX500



## NSVX400T

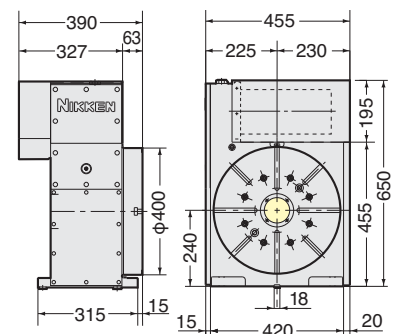
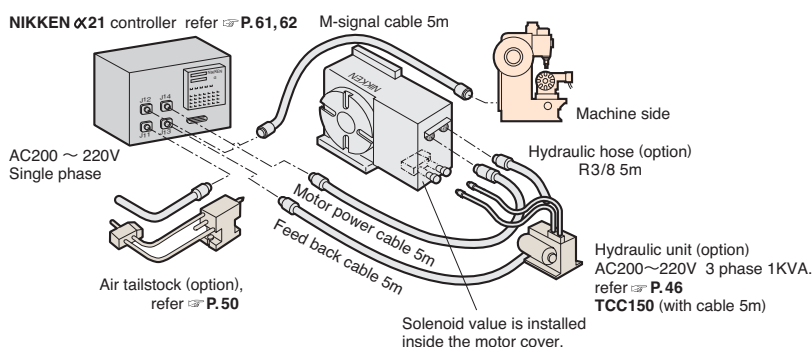
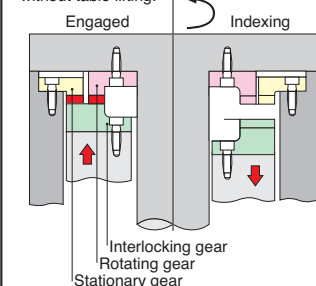


Photo shows only for horizontal use. Please contact us for external dimension.

- ★ For fitting metal and stepped guide piece, refer  $\Rightarrow$  P.22
- ★ For scroll chuck, tailstock and other optional accessories, refer  $\Rightarrow$  P.49,50



**No lift (Three pieces of Hirth Coupling)**  
Three pieces of 360 division precision hirth coupling ensures smooth and fast indexing without table lifting.



# BUILT IN type CNC ROTARY TABLE

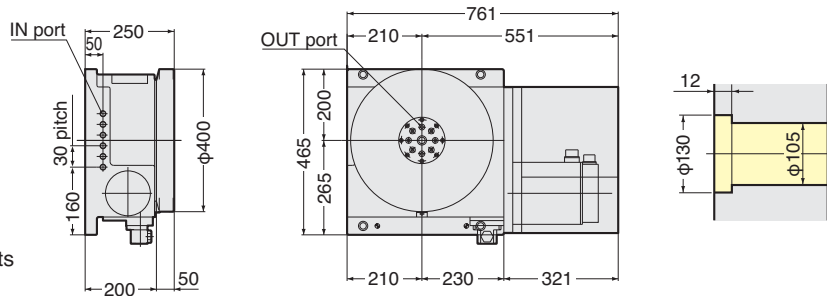


External dimensions will be different according to the type of the servo motors. Dimensions with FANUC motor are shown. Please contact with us for CAD data (2D:DXF, 3D:PARASOLID).

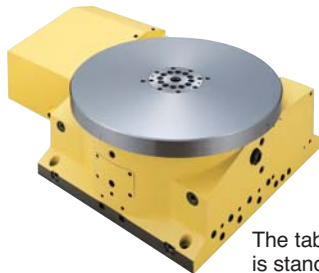
## CNC401H



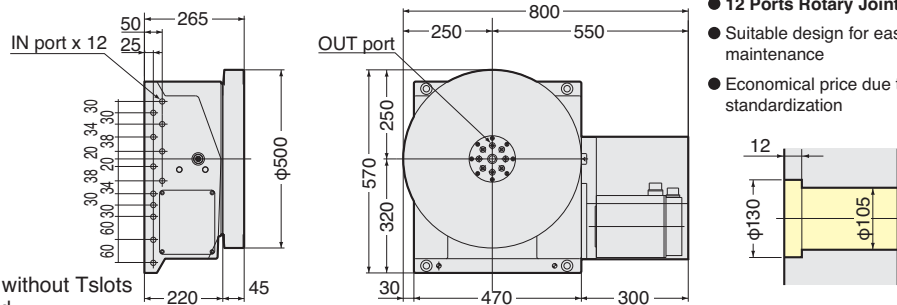
The table without Tslots is standard.



## CNC503H



The table without Tslots is standard.



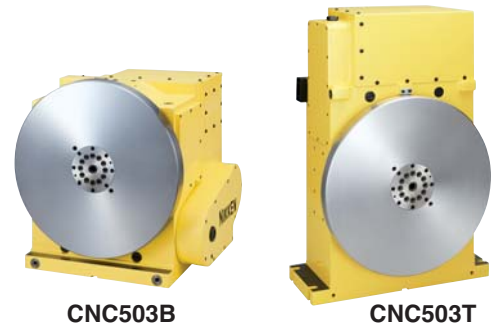
- 12 Ports Rotary Joint is standard.
- Suitable design for easy maintenance
- Economical price due to standardization

## Specifications

( ) : High Speed CNC ROTARY Table Z series

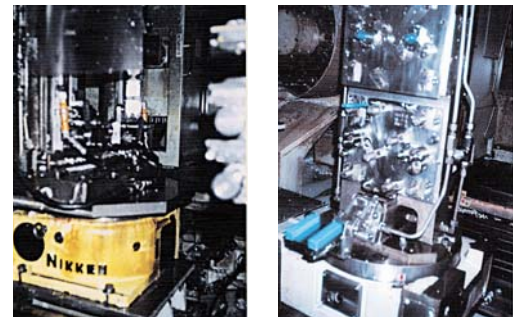
Item / Code No.		CNC401H CNCZ401H	CNC503H CNCZ503H
Diameter of Table	φmm	φ400	φ500
Diameter of Spindle Hole	φmm	φ105	φ105
Clamping System	3.5MPa	Hyd.	Hyd.
Clamping Torque	N·m	1470	1890
Table Inertia at Motor Shaft $(\frac{GD^2}{4})$	kg·m <sup>2</sup> ×10 <sup>-3</sup>	2.8	8
Servo Motor	min <sup>-1</sup>	αiF12/4000·2000	αiF12/4000·2000
MIN. Increment		0.001°	0.001°
Rotation Speed	min <sup>-1</sup>	22.2(44.4)	16.6(33.3)
Total Reduction Ratio		1/90 (1/45)	1/120 (1/60)
Indexing Accuracy	sec	20	20
Net Weight	kg	295	400
MAX. Work Load on the Table	Horizontal	800	1000
		53100	63720
MAX. Thrust Load applicable on the Table	*1	2648	3531
		3840	5990
MAX. Work Inertia	$(\frac{GD^2}{4})$ kg·m <sup>2</sup>	16.6(8.3)	32.5(16.3)
Driving Torque	N·m	432(345)	576(460)

CNC503B, which motor is mounted on the back side, and CNC503T, which motor is mounted on the top side, are available.



## NC Special Purpose Machine

NIKKEN rotary tables are used under the severe conditions due to 24 hours continuous operation.



- ★ \*1 This is the strength of the worm wheel without brake. It is applied against dynamic cutting thrust.
- ★ Ultra precision type is available for all rotary tables, ±3" or ±5", please refer P.53.
- ★ αiF22/3000 motor can be mounted on CNC401H and CNC503.
- ★ The square table is available as an option. Please contact us.
- ★ The supplied hydraulic pressure is 3.5MPa for hydraulic clamping system.

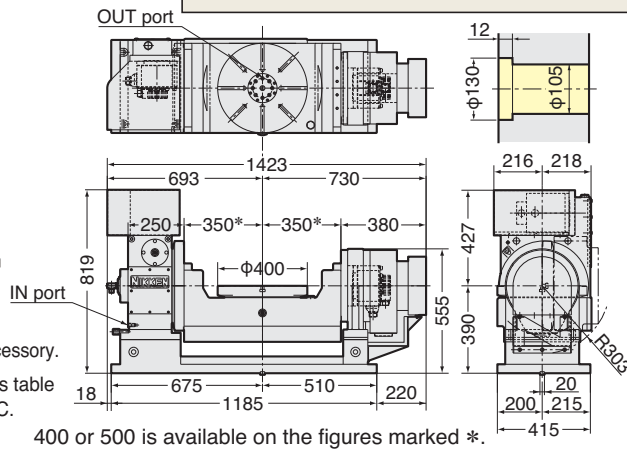
Conditions of CNC rotary table being used on the special purpose machine, refer P.60.

# BUILT IN type TILTING ROTARY TABLE



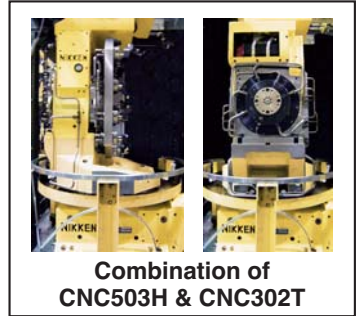
External dimensions will be different according to the type of the servo motors. Dimensions with FANUC motor are shown. Please contact with us for CAD data (2D:DXF, 3D:PARASOLID).

## 5AX-T400



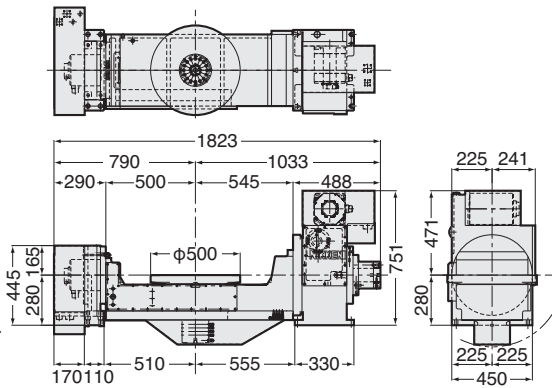
Built-in type 8 ports rotary joint is optional accessory.

- The position of the motor of the tilting axis table can be right & left side for the vertical M/C.



## 5AX-B450

Tilting base will be supplied from M/C builder.



Built-in type 17 ports rotary joint is optional accessory.

- The position of the motor of the tilting axis table can be right or left side for the vertical M/C.

Item / Code No.	5AX-T400	5AX-B450		
Diameter of Table $\phi$ mm	400	500		
Diameter of Spindle Hole $\phi$ mm	$\phi 105H7$	$\phi 155H7 \phi 109$		
Centre Height (90°) mm	390	280*1		
Table Height in Horizontal Position (0°) mm	390	280*1		
Width of T Slot mm	$14^{+0.018}_0$	—		
Axis	Rotary	Tilting	Rotary	Tilting
Clamping System	3.5MPa	Hyd.	Hyd.	Hyd.
Clamping Torque N·m	1760	1760	1760	3870
Table Inertia at Motor Shaft $(\frac{GD^2}{4}) \text{ kg}\cdot\text{m}^2 \times 10^{-3}$	2.8	2.44	2.8	2.9
Servo Motor $\text{min}^{-1}$	aiF12/4000 ·2000	aiF22/4000 ·2000	aiF12/4000 ·2000	aiF22/4000 ·2000
MIN. Increment	0.001°	0.001°	0.001°	0.001°
Rotation Speed $\text{min}^{-1}$	22.2	16.6	22.2	16.6
Total Reduction Ratio	1/90	1/120	1/90	1/120
Indexing Accuracy sec	15	60	20	60
Net Weight kg	750(w/o base) 995(with base)	1050(w/o base)		

Item / Code No.	5AX-T400	5AX-B450	
MAX. Work Load on the Table	0° to 30° 	300	300
	30° to 90° 	250	250
MAX. Thrust Load applicable on the Table	Tilting Angle = 0° 	31360	31360
	Tilting Angle = 0° 	L=200mm F=6860N	L=250mm F=5488N
	Tilting Angle = 90° 	L=100mm F=11660N	L=100mm F=11660N
	Tilting Angle = 90° 	1166	1166
MAX. Work Inertia		5.1	5.1
Driving Torque		432	432

- ★ Range of tilting angle (0°~105°) can be expanded as an option. Please contact us.
- ★ Rotary joint is available for all rotary tables, please refer to P.54.
- ★ Ultra precision type is available for all rotary tables, Rotary axis:  $\pm 5''$  Tilting axis:  $\pm 10''$ , please refer to P.53.
- ★ The supplied hydraulic pressure is 3.5MPa for hydraulic clamping system.
- ★ The figures marked \*1 show the dimension without tilting axis base.

# Servo Motor List

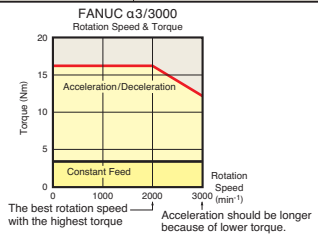


## Maker and Motor Model

Stall Torque	1 Nm	2 Nm	3 Nm	6 Nm	12 Nm	22 Nm
Rotation Speed	2000min <sup>-1</sup>	2000min <sup>-1</sup>	2000min <sup>-1</sup>	2000min <sup>-1</sup>	2000min <sup>-1</sup>	2000min <sup>-1</sup>
Maker	Model 1	Model 2	Model 3	Model 6	Model 12	Model 22
FANUC	αiF1/5000	αiF2/5000	αiF4/5000	αiF8/4000	αiF12/4000	αiF22/4000
	αiS2/5000	αiS4/5000	αiS8/4000	αiS12/4000	αiS22/4000	αiS30/4000
	βiS2/4000	βiS4/4000	βiS8/3000	βiS12/3000	βiS22/2000	
MELDAS			HC52T	HC102T	HC202S	HC352S
			HC53T	HC103T	HC203S	HC353S
	HF75T	HF105T	HF54T	HF104T	HF204S	HF354S
			HP54T	HP104T	HP204S	HP354S
YASNAC			SGMG-05ASACS	SGMG-09ASACS	SGMG-20ASAAS	SGMG-30ASAAS
	SGMP-04A316S	SGMP-08A316S	SGMG-05ASABS	SGMG-09ASABS		
	SGMPH-04AAA6S	SGMPH-08AAA6S	SGMGH-05ACA5S	SGMGH-09ACA5S	SGMGH-20ACA2S	SGMGH-30ACA2S
OSP	OSP2	BL-MC24J-30S	BL-MC25J-30T	BL-MC50J-30T	BL-MC100J-20S	BL-MC200J-20S
	OSP3		BL-ME24J-50SN	BL-ME40J-40TN	BL-ME100J-30SN	BL-ME200J-20SN
TOSNUC			MFA055MBJNC1	MFA100MBJNC1	MFA180MBJNB	MFA350MBJNB
	MDM032R4L	MDM062R4L	MDM052R4L	MDM152R4L	MDM212R4C	MDM402R4C
Brother	SANYO*1	P50B08050DXS00	P50B08075HXS00	P50B08100HXS00		
	SANYO*2	Q2AA08050DXP00	Q2AA08075HXP00	Q2AA08100HXP00		
	SANYO*3			R2AAB8100HXPGA		
	YASNAC	SGMPH-04A4A6S	SGMPH-08A4A6S		SGMPH-15A4A6S	
SIEMENS	1FT-6031-4AK71	1FT-6034-4AK71	1FT-6044-1AK71	1FT-6064-1AK71	1FT-6082-1AF71	1FT-6086-1AF71
		1FK-7042	1FK-7060	1FK-7063	1FK-7083	
INDRAMAT	MAC63A	MAC63C	MAC71B	MAC71C	MAC93B	MAC93C
HEIDENHAIN		QSY96A	QSY116C	QSY116E	QSY155B	QSY155D
ISOFLEX			444,2,20	444,3,20	445,2,20	
SEM		HJ96C6-44	HJ116C6-64	HJ116E6-130	HJ155A8-130	HJ155D8-180
BOSCH	SE-B2.010	SE-B2.020	SE-B3.055	SE-B3.075	SE-B4.130	SE-B4.210
GLENTEK	GM3340	GM4020	GM4040,GM4050	GM5065		
KOLLMORGEN	6SM37L	6SM47L	6SM57L	6SM57M	6SM77K	

- \*1 The end of the rotary table Code No. is "SAIII".
- \*2 The end of the rotary table Code No. is "SA-BR".
- \*3 The end of the rotary table Code No. is "SA-BR2".
- \*The characteristics (stall torque, MAX. torque and rotor inertia etc.) of the servo motors differ, therefore the specification of CNC rotary table will be a little different.
- \*Other servo motor can be mounted, please inform us the external dimension, specification of your servo motor.

Rotation Speed of the motor is normally selected to 2000min<sup>-1</sup>. Depending on the application, the rotation speed of CNC rotary table can be increased to increase the rotation speed of the motor. FANUC αiF series motor can be rotated much higher speed. αiF1, αiF2, αiF4, αiF8, αiF12: 3000min<sup>-1</sup>



## Relation between Unbalancing Load and Servo Motor

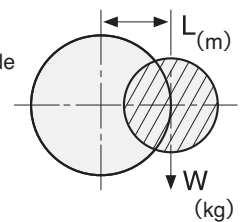


This table shows the guide line. Please make the unbalancing load as small as possible to use the counter balance weight for the precision machining.

Excessive unbalancing load causes the indexing accuracy and the durability to be worse. The relation between the guide line of the unbalancing load and the servo motor shows below. Please do not apply the load exceeding the guide line.

CNCZ series table can not be recommended for the application with large unbalancing load. CNCZ series table is recommended for the application only with light load.

Please inform us the detail of the component, jig fixture, indexing time etc. prior to your order. Then, the calculation of the load is studied and the best suitable rotary table (including the suitable motor) for your application is proposed. The servo parameter is also tuned.



### Guide Line of MAX. Unbalancing Load for Additional Axis Control

FANUC motor is described. Please contact us for the other maker.

MAX. Unbalancing Load (kgm)	CNC180FA	CNC202FA	CNC <sup>260FA</sup> <sub>302FA</sub>	CNC <sup>321FA</sup> <sub>401FA</sub>	CNCB450FA	CNC <sup>501FA</sup> <sub>601FA</sub>
3.0	αiF2					
5.0	αiF4	αiF4	αiF4			
10.0			αiF8	αiF12		
15.0					αiF12	
20.0				αiF22		αiF12
30.0					αiF22	
40.0						αiF22

### Guide Line of MAX. Unbalancing Load with NIKKEN Controller

MAX. Unbalancing Load (kgm)	CNC180	CNC202	CNC260	CNC302
1.0	CNC180AA21-04			
2.0	CNC180AA21-08	CNC202AA21-08		
3.0			CNC260AA21-08	CNC302AA21-08
5.0	CNC180AA21-06	CNC202AA21-06	CNC260AA21-06	CNC302AA21-06

# Flow Chart of the Additional Axis Control

Servo enable is basically kept OFF during the mechanical brake clamps. Servo enable is recommended to be kept ON, even when the mechanical brake clamps for the CNC rotary tables listed in the box below. But, the case when a big electric current always flows in the motor due to the heavy unbalancing load, please keep servo enable OFF when the mechanical brake clamps.

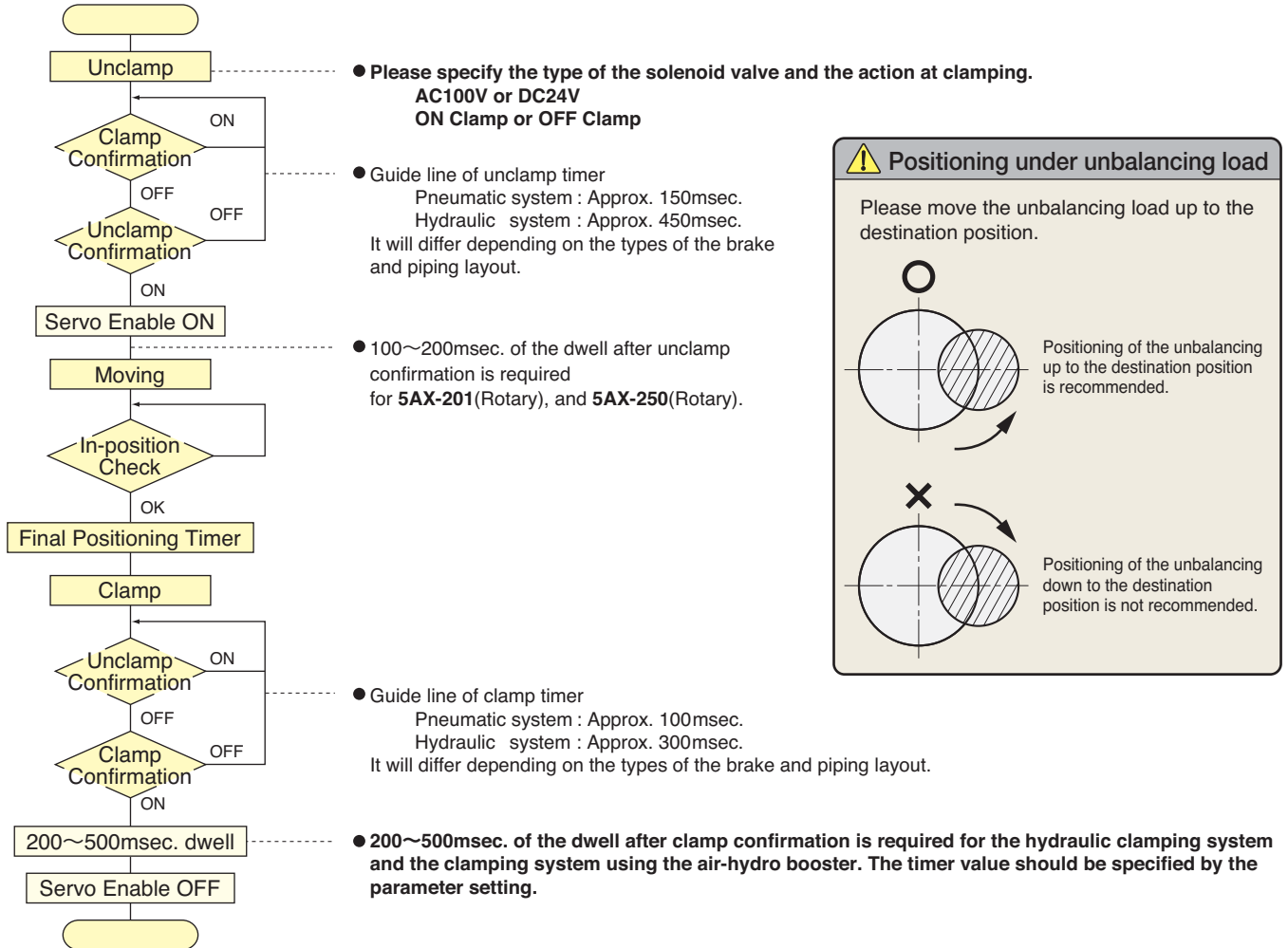
- CNC321, 401, 501, 601
- CNC401H, 503H
- 5AX-250 (Tilting)
- 5AX-T400 (Rotary, Tilting)



Please specify the brake control when ordering

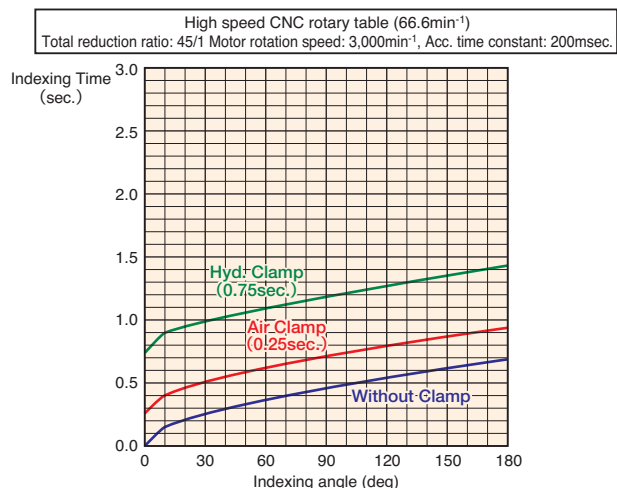
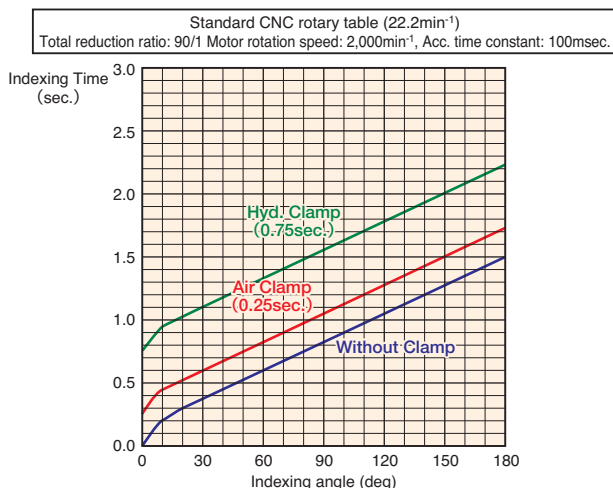
- Type of solenoid valve (AC100V or DC24V)
- Motion of solenoid valve for clamp (ON: Clamp, OFF: Clamp)

## Flow Chart of the Additional Axis Control



# Indexing Time

Guide line of the indexing time is shown. The indexing time will be different according to the total reduction ratio, motor rotation speed, servo parameter setting and the piping of the brake circuit. Please contact us for more detail.

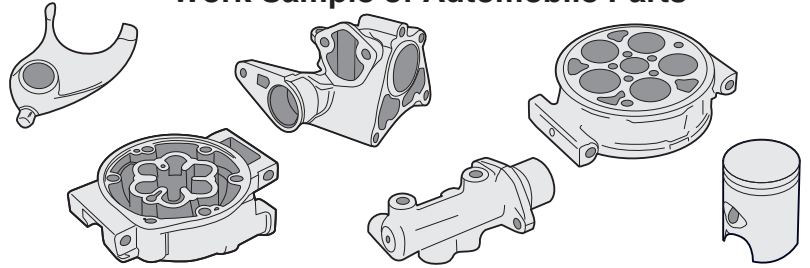


# CNC ROTARY TABLE for Small Machine 1



Current development of production technology in automobile industry is remarkable improved, and the work pieces that used to be machined by medium/large BT40/50 spindle M/C can now be carried by small M/C or T/C with BT30/NC5-46 spindle. The following are the typical CNC rotary tables used on the small M/C or T/C.

## Work Sample of Automobile Parts



## CNC Rotary Table for BROTHER T/C & *SPEEDIO*



There are two types of the servo motor for **CNC-A00 (SAⅢ)** or for **CNC-B00 (SA-BR, SA-YA)**. The type of the servo motor depends on the kind of the tapping center. Please specify the kind of the tapping center and the location of the CNC rotary table (right or left), when ordering. Nikken will supply CNC rotary table with the suitable servo motor, amplifier, and the connection cables. Please refer the exclusive catalogue of **BROTHER**.

TC-32BNQT	CNC180LYA-BR, 202LYA-BR
	5AX-130BAYA-BR
	5AX-2MT-105-120BAYA-BR

TC-S2D	CNC105LSA-BR
	CNC180LSA-BR, 202LSA-BR
	CNC260LSA-BR
	5AX-130SA-BR, 5AX-201SA-BR
	5AX-200ⅡBASA-BR

Example **CNC202LYA-BR on TC-32BNQT x2** (CNC180LYA-BR is also available.)



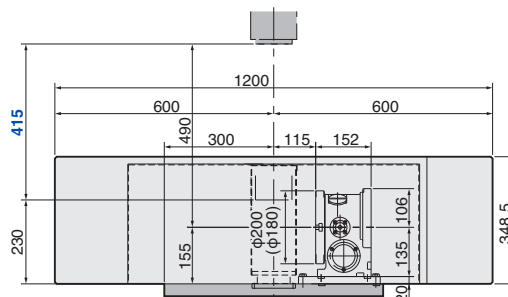
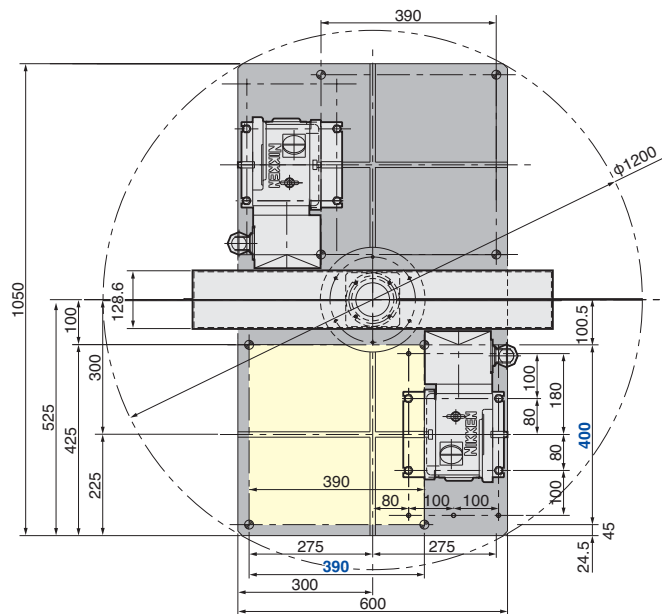
CNC100L X 2 units on TC-31AN with Robot



CNC202LYA-BR



External Solenoid Valve Unit to be mounted on T/C Power Circuit Panel.



★Figures with blue bold show the strokes of Tapping Center.

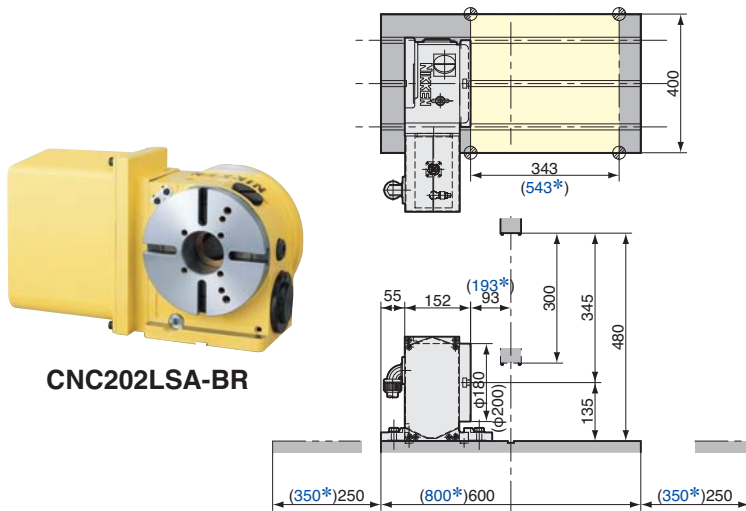


# CNC ROTARY TABLE for Small Machine 2

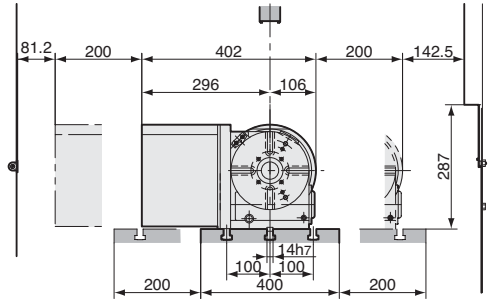


## CNC Rotary Table for BROTHER TAPPING CENTER

Example **CNC202LSA-BR on TC-S2D** (CNC180LSA-BR is also available.)

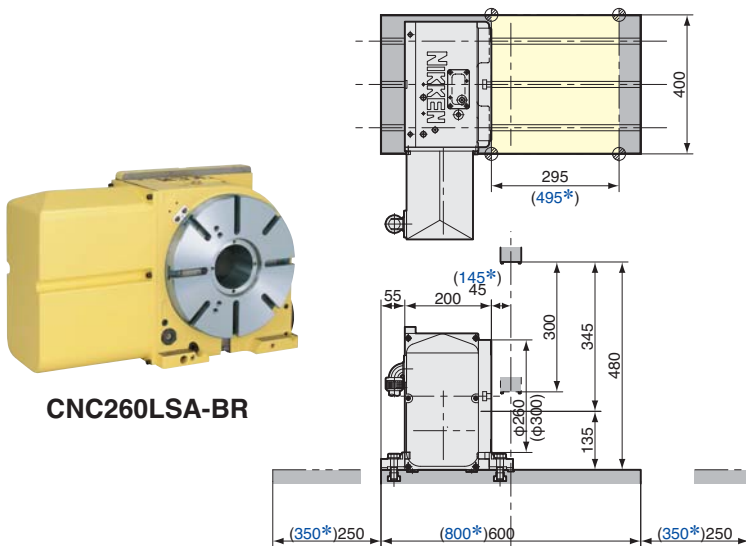


CNC202LSA-BR

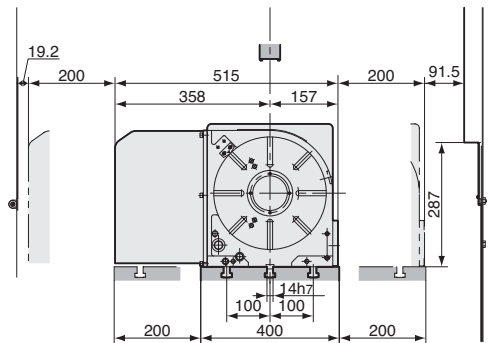


The figures on ( \*) means the figures for TC-S2D-O.

Example **CNC260LSA-BR on TC-S2D**

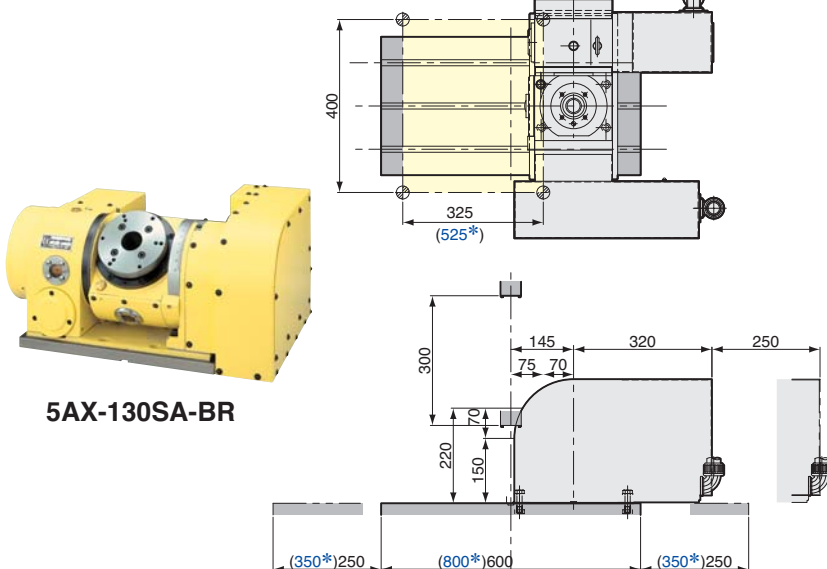


CNC260LSA-BR



The figures on ( \*) means the figures for TC-S2D-O.

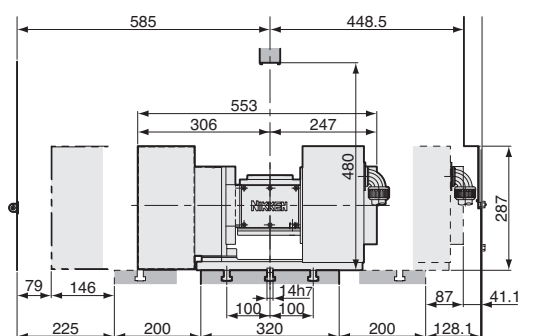
Example **5AX-130SA-BR on TC-S2D**



5AX-130SA-BR



5AX-130SA-BR on TC-S2D



The figures on ( \*) means the figures for TC-S2D-O.

# CNC ROTARY TABLE for Small Machine 3



## CNC Rotary Table for BROTHER *SPEEDIO* Series S500X1, S700X1

“SA-BR2” is added at the end of rotary table Code No.

SPEEDIO™ S500X1 S700X1	CNC105LSA-BR2
	CNC180LSA-BR2, 202LSA-BR2
	CNC260LSA-BR2
	5AX-130SA-BR2
	5AX-201SA-BR2

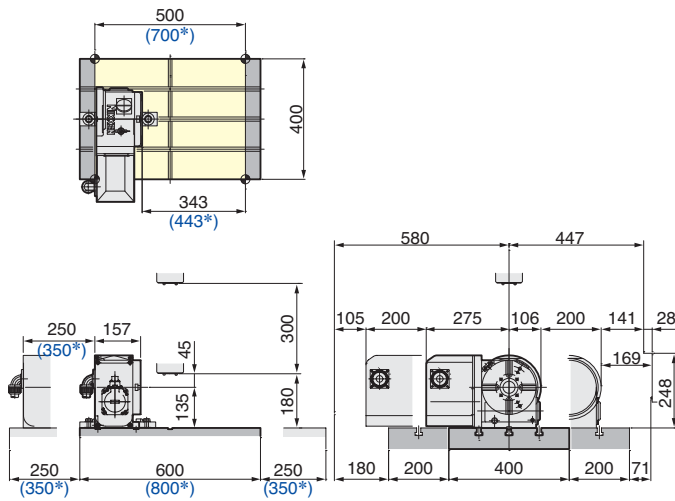
(NC:CNC-C00 series)



CNC202LSA-BR2

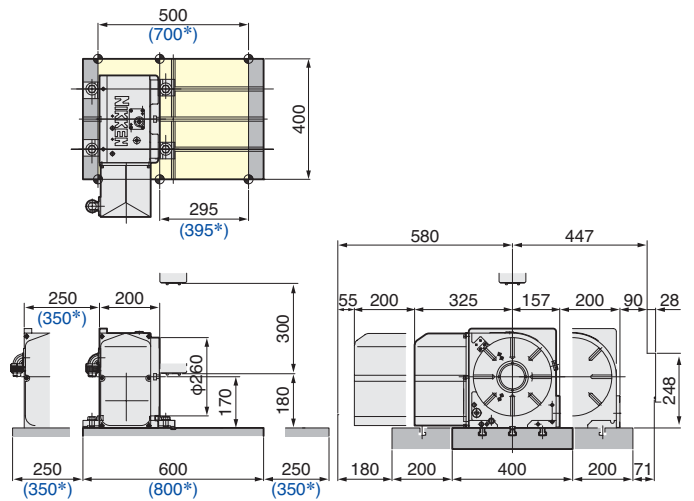
### Example CNC180LSA-BR2 on S500X1

(CNC202LSA-BR2 is also available.)



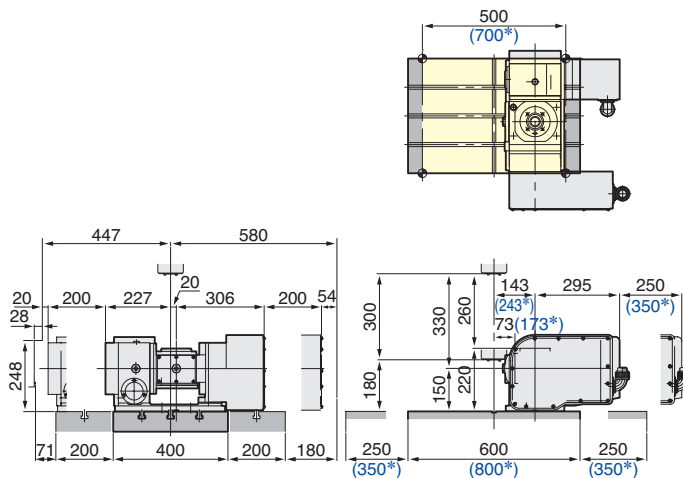
The figures on ( \*) means the figures for S700X1.

### Example CNC260LSA-BR2 on S500X1



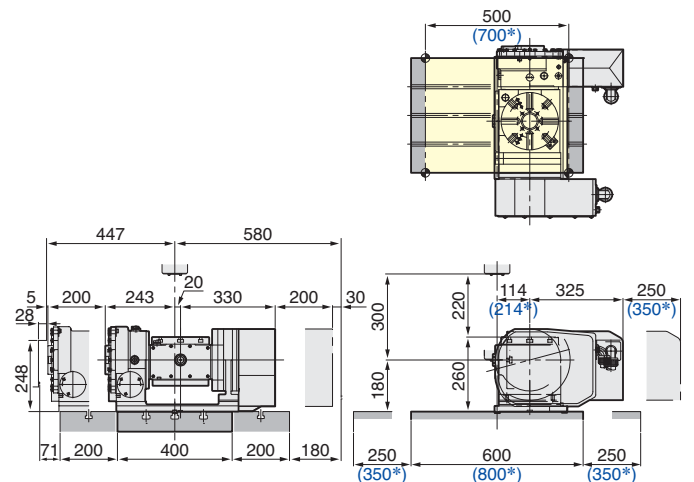
The figures on ( \*) means the figures for S700X1.

### Example 5AX-130SA-BR2 on S500X1



The figures on ( \*) means the figures for S700X1.

### Example 5AX-201SA-BR2 on S500X1



The figures on ( \*) means the figures for S700X1.

# CNC ROTARY TABLE for Small Machine 4



## CNC Rotary Table for FANUC ROBO DRILL

CNC180LFA/202LFA as the 4th axis rotary table, 5AX-130FA/201FA as the 4th and 5th axes rotary table are typical rotary table for FANUC ROBO DRILL. Please refer the exclusive catalogue of FANUC. DD250 P.41 and 5AX-DD200 P.42 can be installed. Please contact us.

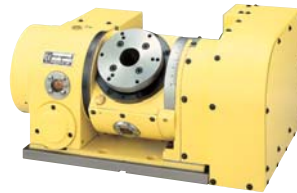
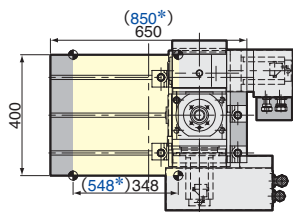


CNC202 & ROBOT



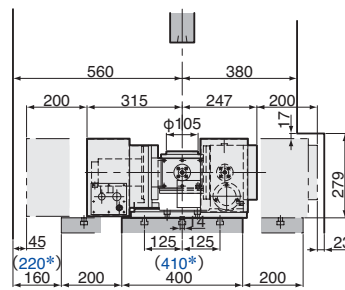
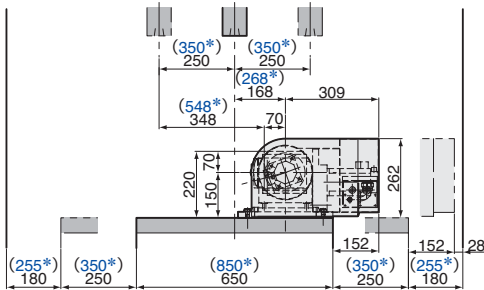
5AX-130 & ROBOT

### Example 5AX-130FA on ROBO DRILL



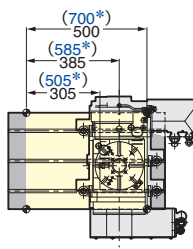
#### φ130mm type 5AX TILTING ROTARY TABLE

- Diameter of Table : φ130mm(with φ130 sub table)
- MAX. Work Load : 50kg (Horizontal) 25kg (Vertical)
- MAX. Rotation Speed : 22.2min<sup>-1</sup>(Rotary), 11.1min<sup>-1</sup>(Tilting)
- Indexing Accuracy : ±30sec.(Rotary), 60sec.(Tilting)
- Brake Torque : 205Nm(Rotary), 303Nm(Tilting)
- Net Weight : 99.5kg
- Servo Motor : AC&F2(Rotary), AC&F2(Tilting)  
Q2AA08075HXP3S(Tilting)
- Spindle Hole : φ60mm H7×φ30mm Through Hole
- Tilting Angle : 0°~105°



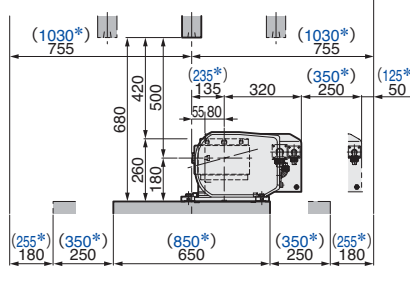
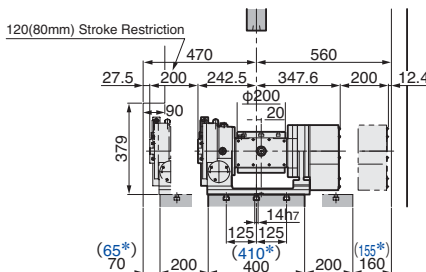
The figures on ( \*) means the figures for &T14iFL/&T21iFL.

### Example 5AX-201FA on ROBO DRILL



#### φ200mm type 5AX TILTING ROTARY TABLE

- Diameter of Table : φ200mm
- MAX. Work Load : 60kg (Horizontal) 40kg (Vertical)
- MAX. Rotation Speed : 22.2min<sup>-1</sup>(Rotary), 16.6min<sup>-1</sup>(Tilting)
- Indexing Accuracy : ±20sec.(Rotary), 60sec.(Tilting)
- Brake Torque : 588Nm(Rotary), 608Nm(Tilting)  
(Hyd. 3.5MPa)  
303Nm(Rotary), 303Nm(Tilting)  
(Air 0.5MPa)
- Net Weight : 160kg
- Servo Motor : AC&F2(Rotary), AC&S4(Tilting)
- Spindle Hole : φ60mm H7×φ50mm Through Hole
- Tilting Angle : 0°~105°

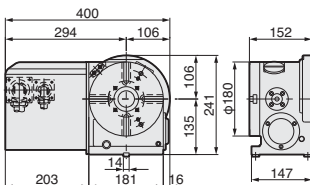


The figures on ( \*) means the figures for &T14iFL/&T21iFL.

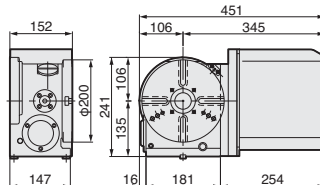
There is 80mm stroke restriction on the ROBO DRILL of standard or with 100mm higher colour.

We have further applications and experiences for installation on other model or other makers M/C. Please contact us for the details.

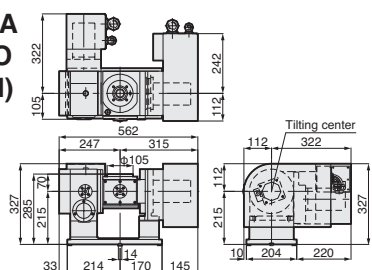
#### CNC180LFA for KIRA M/C



#### CNC202FA for TOYOSK M/C



#### 5AX-130HYA for MIYANO (MECTRON)



# ROTARY TILTING TABLE with DD MOTOR

**NEW**

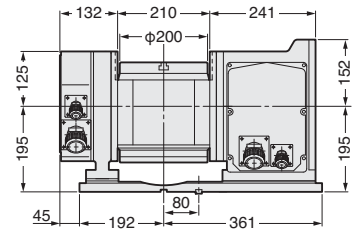
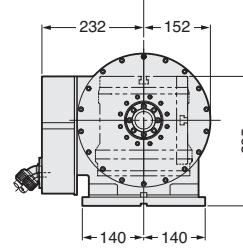
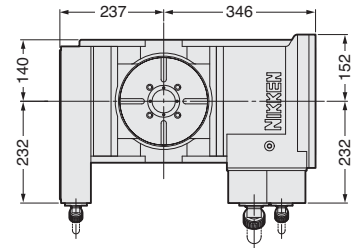
**NIKKEN**

- Indexing of 90° on Rotary Axis: Within 0.2sec.
- Tilting Axis : Within 0.3sec.



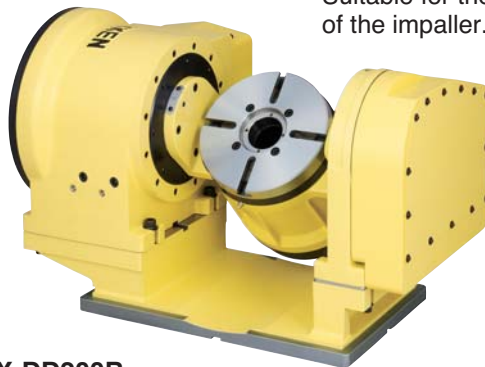
5AX-DD200A

5AX-DD200A



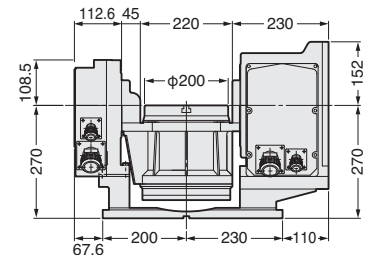
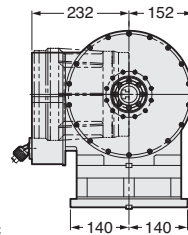
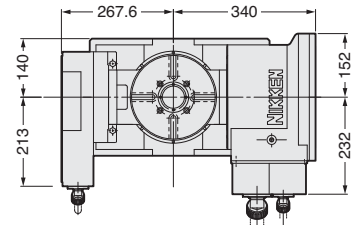
★\*1 The tilting axis center is located in the same position as the center of the rotary axis body for 5AX-200A.

Suitable for the machining of the impeller.



5AX-DD200B

5AX-DD200B



★\*1 The tilting axis center is located in the same position as the top surface of the rotary axis for 5AX-200B.

● Explanation of the Code No. (Example)

**5AX - DD 200 A F 2**

- Version
- Motor Maker  
F: FANUC M: MELDAS Y: YASNAC
- Location of the tilting axis centre\*1 A, B
- Diameter of Table: 200
- DD: With DD motor
- 5AX: Tilting rotary table

## Specifications

The external dimension and the specification will be varied according to the DD motor. Please contact us.

Item / Code No.		5AX-DD200AF2*2		5AX-DD200BF2*2	
Diameter of Table	φmm	200		200	
Diameter of Spindle Hole	φmm	53H7		53H7	
Centre Height (90°)	mm	195		270	
Table Height in Horizontal Position (0°)	mm	295		270	
Width of T Slot	mm	12H7		12H7	
Axis		Rotary	Tilting	Rotary	Tilting
Clamping System		Air (0.5MPa)	Air (0.5MPa)	Air (0.5MPa)	Air (0.5MPa)
Clamping Torque Nm	Nm	150	500	150	500
Motor (FANUC)		DiS60/400	DiS150/300	DiS60/400	DiS150/300
Encoder		αiCz 512A		αiCz 512A	
Min. Incremental	deg.	0.001		0.001	
Rotation Speed	min <sup>-1</sup>	200	150	200	150
indexing Accuracy	sec.	±10	±15	±10	±15
MAX. Torque	Nm	130	380	130	380
Constant Torque	Nm	24	73/170*1	24	73/170*1
Net Weight	kg	190		185	
MAX. Work Load	0~30deg. kg	30		30	
	0~90deg. kg	15		30	

★The figure marked \*1 shows the figure with cooling system.

★\*2 The DD motors for the first version of 5AX-DD200A and 5AX-DD200B are ; Rotary: DiS85/400, Tilting: DiS260/300 This table shows the second version.

# ROTARY TILTING TABLE with DD MOTOR

**NEW**

**NIKKEN**

## 5AX-DD Table for FANUC ROBO DRILL

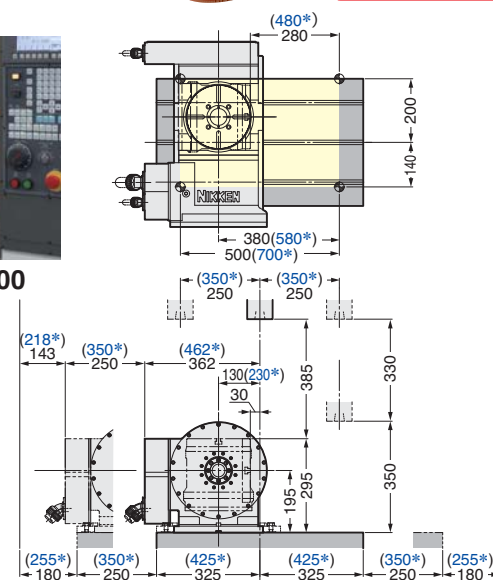
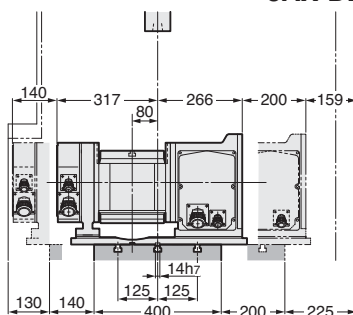
### 5AX-DD200AF2



Layout for the ROBO DRILL with 200mm high column

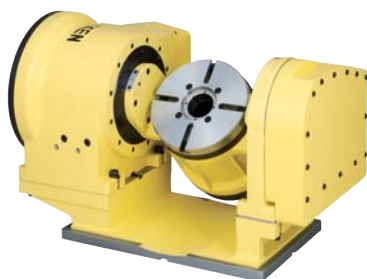


5AX-DD200

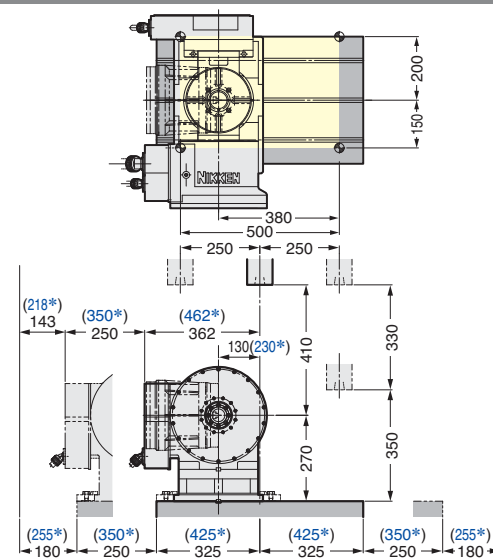
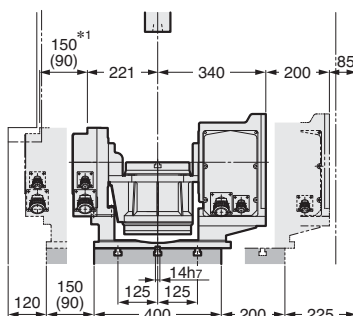


(\*) : Figures with blue color is for  $\alpha$ -T14iFL /  $\alpha$ -T21iFL.

### 5AX-DD200BF2



Layout for the ROBO DRILL with 200mm high column



(\*) : Figures with blue color is for  $\alpha$ -T14iFL /  $\alpha$ -T21iFL.

\*1 The stroke restriction of 50mm for the standard cover.  
The stroke restriction of 110mm for the metal cover.

## The Area of Noninterference in Tilting Position.

Angle	5AX-DD200AF2	5AX-DD200BF2
-45° ∩ 45°		
-90° ∩ 90°		
-110° ∩ 110°		

## Accuracy Standard

No.	Measuring Item	Measuring Method	5AX-DD200AF2	5AX-DD200BF2
1	Parallelism between table surface and frame bottom at tilting angle 0°		0.01mm	0.01mm
2	Deviation of table surface at tilting angle of 0°		0.01mm	0.01mm
3	Deviation of table centre hole at tilting angle 0°		0.01mm	0.01mm
4	Displacement of centre when moving from 0° to 90° at tilting angle 90°		0.015mm	0.015mm
5	Parallelism between table surface and centre line of guide key at tilting angle 90°		0.01mm	0.01mm
6	Indexing accuracy of rotary axis		±10"	±10"
7	Repeatability of rotary axis		4"	4"
8	Indexing accuracy of tilting axis	累積	±15"	±15"
9	Repeatability of tilting axis		6"	6"

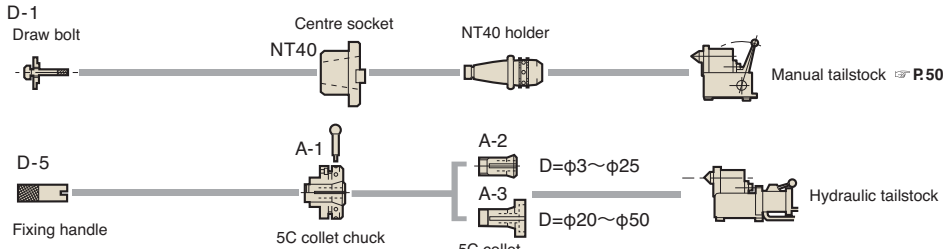


# Attachment for $\alpha$ Series CNC ROTARY TABLE



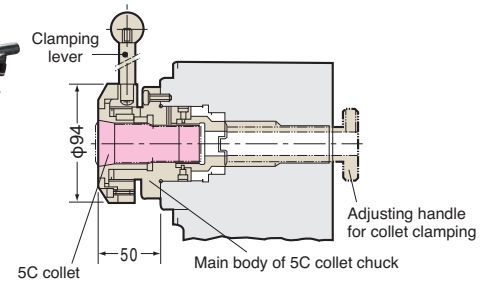
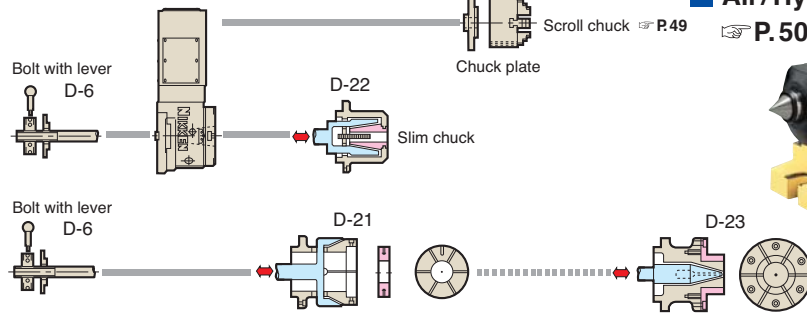
All of  $\alpha$  Series CNC Rotary Tables, as the through holes are standardized  $\phi 60$  straight hole, they have same attachment in common. Plentiful attachment can be supplied according to your application.

## 5C Collet Chuck

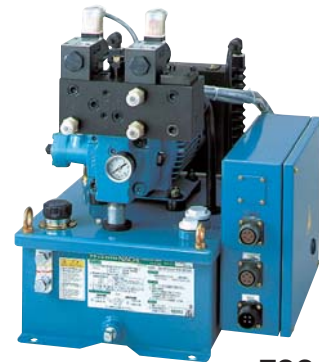
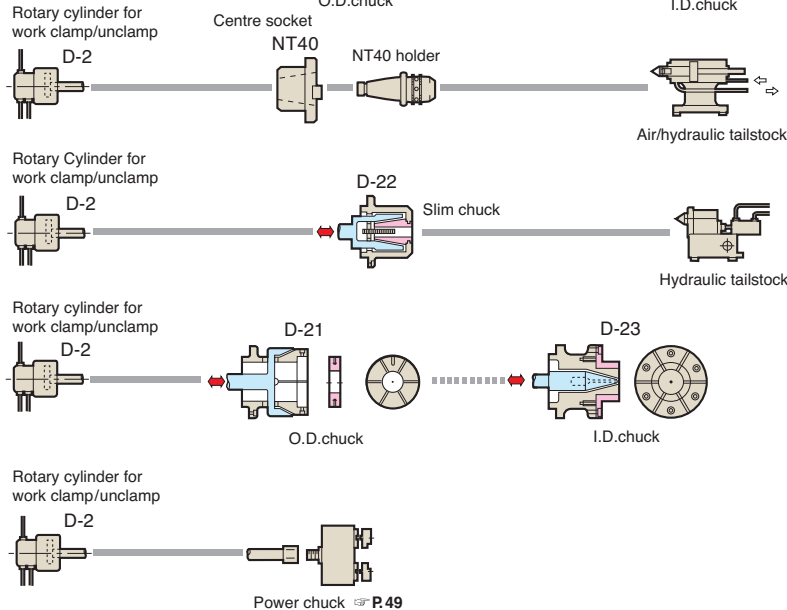


CNC105A21-5C

## Air/Hydraulic Tailstock



## Hydraulic Unit

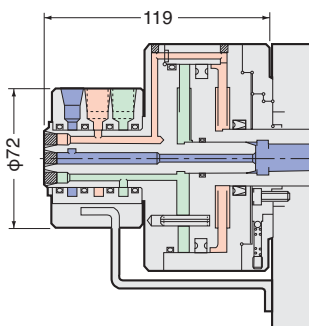


TCC-150

### Specifications

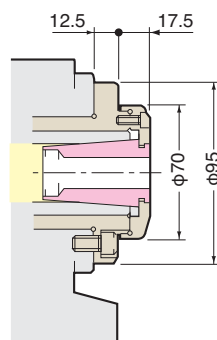
- MAX. 14l/min.
- MAX. 3.5MPa
- AC 200~220V, 3 phases, Capacity : 1KVA.
- Solenoid valves and pressure switches depends on your applications.
- Dimension : 400x405x479mm

## Rotary Cylinder for Work Clamp/Unclamp



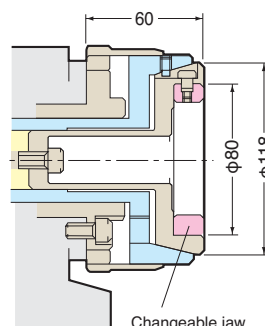
Pulling Force:  
3130KN at air 0.5MPa  
(Hydraulic cylinder is also available)

## Slim Chuck



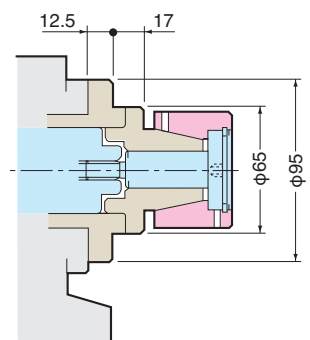
SK Collet  
SK10:  $\phi 0.75 \sim \phi 10\text{mm}$   
SK16:  $\phi 2.75 \sim \phi 16\text{mm}$   
SK25:  $\phi 16 \sim \phi 25.4\text{mm}$

## O.D.Chuck



Chucking range:  $\phi 25 \sim \phi 80\text{mm}$

## I.D.chuck

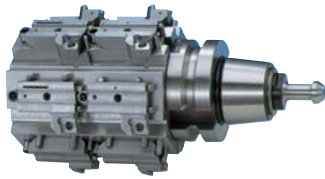


Chucking range:  
 $\phi 10 \sim \phi 12\text{mm}$   $\phi 30 \sim \phi 40\text{mm}$   
 $\phi 13 \sim \phi 16\text{mm}$   $\phi 40 \sim \phi 50\text{mm}$   
 $\phi 17 \sim \phi 20\text{mm}$   $\phi 50 \sim \phi 60\text{mm}$   
 $\phi 20 \sim \phi 30\text{mm}$





## Work Fixing Jig Holder

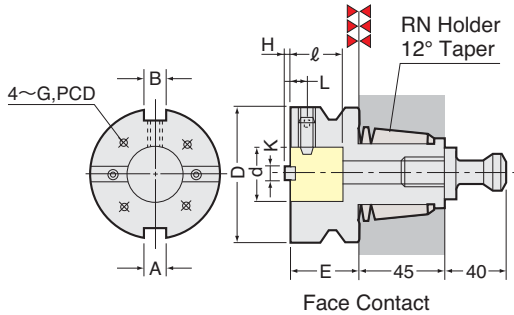
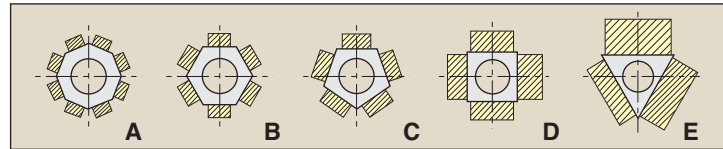


Whether Work Fixing Jig Holder is suitable to the work or not results in big difference in productivity. We have wide and deep experiences and know-how. Please contact us.

Side Lock type Holder

Code No.	D1	d	K	E	H	R	L	M	G	PCD	A <sup>0</sup> <sub>-0.010</sub>	B	Weight
RN40-63x25	63	25H6	10h7	40	5	30	15	M10	M8	48	16	18	1.5kg
RN45-85x32	85	32H6	12h7	45	5	35	20	M12	M10	65	18	20	2.5kg

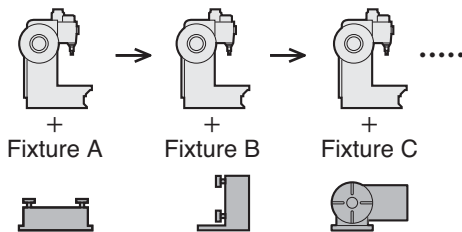
Examples of Jig Block (Option)



Standard Pull Stud : PS-3  
Holder with ID, Pull Stud with ID are available. (Option)

## Advantage of 5AX-Table in Automation Production Line

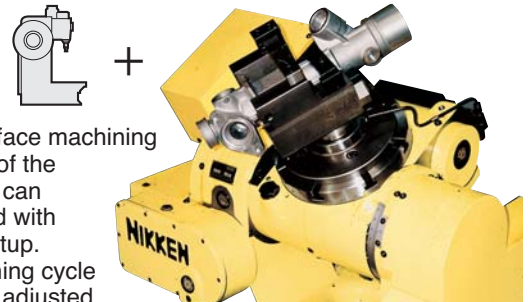
The originally system



It's necessary to prepare suitable jig fixtures for each process, then the machining cycle time will be adjusted with increasing the number of processes.

- It's difficult to obtain the exactly same reference location in each operation, therefore it's easy to affect the finish quality.
- If the one machine breaks down, all of the production line will be stopped.
- The cost and the delivery for making a new jig fixture for the new design causes problems.

System with 5AX-Table

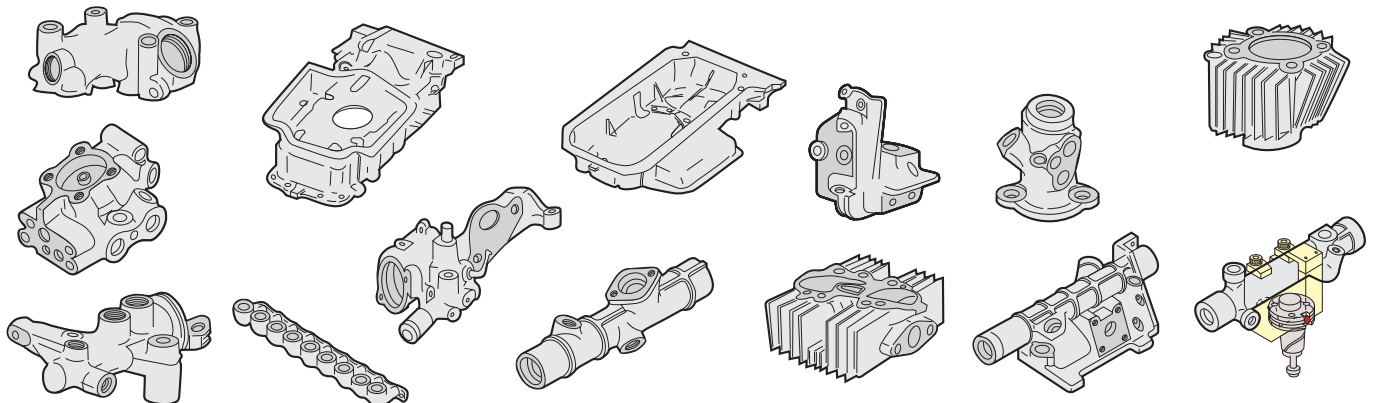


The full surface machining on top half of the component can be achieved with only one setup.

The machining cycle time will be adjusted with increasing the number of machines.

- As the full surface machining can be done with only one setup, the finish quality will be improved.
- Even if one machine breaks down, the extended operation time on another machine can achieve same quantity of production.
- It's easy and quick to machine new design component only by changing machining program.
- The random production can be done by the jig holder with ID tip. (That's ideal for the automotive production line as there are many pair parts of right and left.)

## Work Samples



# SCROLL CHUCK & POWER CHUCK



Chuck Plate

Scroll Chuck



Holes for bolts of Front Mounting

- Scroll Chucks with chuck plate marked \* are NIKKEN Scroll Chuck of Front Mounting (Fig.1)
- NIKKEN Scroll Chuck is used for X-4B, X-6E & X-9F.
- The chuck plates for the scroll chucks without \* can be used for the scroll chuck based on JIS B6151 SC/TC standard.

## List of Scroll Chuck & Chuck Plate

Scroll Chuck Table Model	4"	5"	6"	7"	9"	10"	12"
CNC105	X-4B						
CNC180		X-5C*	X-6B*				
CNC202		X-5C*	X-6B*	X-7A*			
CNC260, 302			X-6G*	X-7L*	X-9H, X-9J <sup>1)</sup>		
CNC321, 401				X-7N, 7K <sup>2)</sup>	X-9K, 9D <sup>2)</sup>	X-10G, 10D <sup>2)</sup>	X-12F, 12G <sup>2)</sup>
CNC501, 601					X-9D	X-10	X-12B
NST250		X-5B	X-6A	X-7B			
NST300		X-5B	X-6A	X-7B	X-9A	X-10B-1	X-12A-1
NST500				X-7G	X-9B	X-10C	X-12
5AX-130	X-4B						
5AX-201	X-4B	X-5C*	X-6B*	X-7A*			
5AX-230			X-6B*	X-7A*	X-9F		
5AX-350				X-7M	X-9J	X-10E-1	X-12D-1
NSVZ180			X-6E				
NSVZ300			X-6A	X-7B	X-9A	X-10B-1	
NSVX400				X-7D	X-9C	X-10A	X-12C

★Chuck plate marked \*1 is used for φ300 table.  
★Chuck plates marked \*2 are used for φ400 table.

## Chucking Range

Chuck Size	Range	
	External	Internal
4"	2~ 89	36~ 78
5"	3~104	42~ 92
6"	3~135	52~119
7"	3~153	56~134
9"	4~190	64~169
10"	10~229	72~208
12"	10~258	82~238

This is the actual gripping range not jaw stroke.

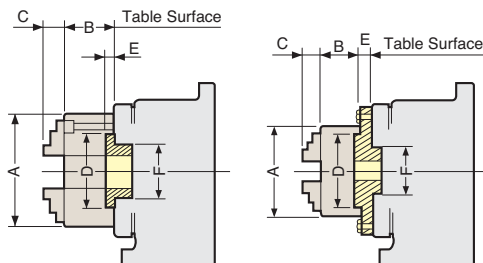


Fig.1

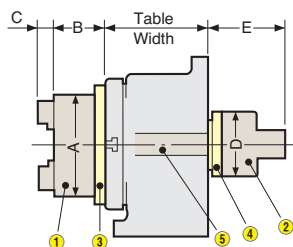
Fig.2

## Front End Dimensions with Scroll Chuck & Chuck Plate

Chuck Size	Chuck Plate Code No.	A	B	C	D	E	F	Fig. No.
4"	X-4B	112	58	31.75	80	13	60	2
	X-5B	132	60	37.25	100	16	60	2
X-5C*	3.5							
6"	X-6A	167	66	44.25	130	16	60	2
	X-6B*					4		
	X-6E					15		
	X-6G*					4		
	X-7A*, X-7L*					4		
7"	X-7B	192	75	46.25	155	16	60, 80	2
	X-7D, 7M					80		
	X-7G					18		
	X-7K, 7N					16		
	X-7A*, X-7L*					105		
9"	X-9A, 9B, -9C, 9G	233	82	55.25	190	18	60,75 80,105	2
	X-9D, 9F					20		
	X-9H					25		
	X-9J, 9K					18		
10"	X-10, 10A-10C	274	86	53.25	230	20	130,70,75	2
	X-10B-1, 10E-1					25		
	X-10D, 10G					20		
12"	X-12, 12B -12C, 12G	310	92	59.25	260	20	75,130 80,105	2
	X-12D-1, 12F-1					25		

★The maker of the scroll chuck was changed. This table shows the chuck plate of the new maker. Please refer CAT NO.8168 or older for the chuck plate of the old maker.

★The dimension from the table surface to the jaw is; [ \* ]:B+C Others: E+B+C



- 1 Power Chuck
- 2 Rotary Cylinder
- 3 Chuck Adapter
- 4 Cylinder Adapter
- 5 Connecting Rod

When power chuck or rotary cylinder is attached on 5AX-table, the 5AX-table must be High Column table.

## Power Chuck & Rotary Cylinder

Chuck Size	Power Chuck Code No.	Rotary Cylinder Code No.	A	B	C	D	E	MIN.Table φ
4"	HOIMA-4	HH4C-80	110	70	27	115	215	φ 100
		HO5CH-100				130	220	
5"	HOIMA-5	HH4C-80	135	70	27	115	215	φ 150
		HO5CH-150				186	235	
6"	HOIMA-6	HH4C-100	165	94	43	135	240	φ 180
		HO5CH-175				210	240	
8"	HOIMA-8	HH4C-125	210	110	43	160	250	φ 250
		HO5CH-250				290	295	
10"	HOIMA-10	HH4C-125	254	120	43	160	250	φ 300
		HO5CH-300				340	310	
12"	HOIMA-12	HH4C-140	304	140	53	180	260	φ 320
		HO5CH-300				340	310	

★HOWA power chucks and rotary cylinders (Higher:hydraulic, Lower:Air) are listed. Other maker's one can be mounted, please specify the Code No.

★Above power chucks are not applicable to NST Table. Please contact with us for mounting.

★Rotary cylinder for 5AX-table is NIKKEN made.

★NIKKEN air/hydraulic rotary cylinder is also available.

# TAILSTOCK (MANUAL, AIR, HYDRAULIC)



Manual Tailstock



Air/Hyd. Tailstock



Hyd. Tailstock



Photo shows support table with T slot (Option).

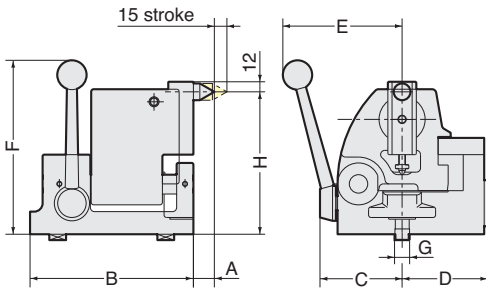
Support Table TAT P. 6, 18

## List of Tailstock and Support Table

Table Model	Centre Height	Tailstock			
		Manual Stroke: 15mm	Air/Hyd. Tailstock Stroke: 60mm	Hyd. Tailstock Stroke: 100mm	Support Table Built-in Brake (Hyd.)
CNC105	105	P-105S	PBA-105		TAT105
CNC180, 202	135	P-125S	PBA-135		TAT170
CNC180B, 202B	180	P-170S	PBA-180	H-170S	
NST250	155	P-150S		H-150S	
CNC260, 302	170	P-170S	PBA-170	H-170S	TAT250
CNC321, 401	230	P-230S		H-230S	TAT321,401
CNC501, 601	310	P-310S			TAT501,601
NST300	208	P-210S		H-210S	
NST450, 500	288	P-280S			
5AX-130	150	P-150S	PBA-150	H-150S	
5AX-201	180	P-170S	PBA-180	H-170S	
5AX-230	240	P-230S		H-230S	
5AX-250*	250				
5AX-350	300	P-310S			
CNC100-2, 3, 4W	105		PBA-105-2,3,4W		
NSVZ180	135	P-125S	PBA-135		
NSVZ300	170	P-170S	PBA-170	H-170S	TAT250
NSVX400	240	P-230S		H-230S	TAT401

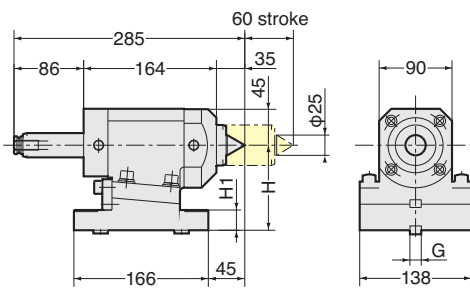
\*Please contact us about the Tailstock for 5AX-250.

## Dimension of Manual Tailstock



The centre height can be adjusted. Please refer Centre Height H on the table.

- ★ Left handed tailstocks are available in all sizes.
- ★ For P-150S or larger size tailstocks, 5 pcs of changeable centres are included.

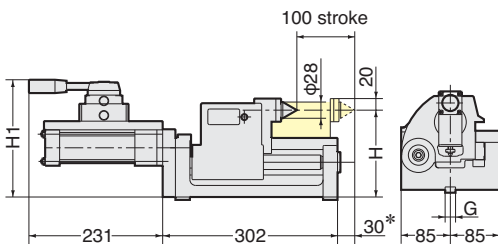


The centre height can be adjusted within 0.35mm.

## Air/Hyd. both usable Small Size Tailstock

Code No.	Centre Height H	H <sub>1</sub>	G	Thrust (N)		Weight (Kg)
				Air 0.5MPa	Hyd. 2MPa	
PBA-105	105	25	14	1176	4733	15
PBA-135	135	55	14	1176	4733	20
PBA-150	150	70	18	1176	4733	22
PBA-170	170	90	18	1176	4733	24.5
PBA-175	175	95	18	1176	4733	25
PBA-180	180	100	18	1176	4733	25.5

- ★ Rotary centre is built-in.
- ★ MT (Morse Taper) type quill is also available. Please contact with us.
- ★ The different length of the stroke is available. Please contact us.



The centre height can be adjusted. Please refer Centre Height H on the table.

## Hydraulic Tailstock

Code No.	Centre Height H	H <sub>1</sub>	G	Thrust (N)	Weight (Kg)
				Hyd. 3.5MPa	
H-150S	145~160	191	18	5370	28
H-170S	160~180	211	18	5370	35
H-210S	200~220	251	18	5370	41
H-230S	220~240	271	18	5370	45

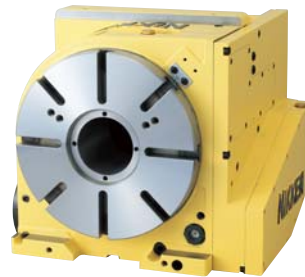
- ★ Rotary centre is built-in.
- ★ MAX. work piece diameter must be smaller than  $\phi 130$ mm, when the stroke of changing the work piece is more than 30mm marked \*.

- For Support Table TAT, refer P. 6, 18
- For details of CNC rotary table for tailstock, please contact with us for more details.
- In case of air/hyd. tailstock, the hydraulic unit, connecting cables and air/hyd. hoses are supplied as an option.

## CNC Rotary Table only for Vertical Use... Back side motor mounted type P.13, 14 Top side motor mounted type P.15~P.18

No.	Measuring Item	Measuring Method	CNC180 202	CNC260 302	CNC321 401	CNCB350 450	CNC501 601
2	Runout of table surface		0.01 mm	0.015 mm	0.015 mm	0.015 mm	0.02 mm
3	Concentricity of centre bore		0.01 mm	0.01 mm	0.01 mm	0.01 mm	0.01 mm
4	Squareness of table surface (Minus deviation at upper part is not permitted.)		0.02 mm	0.02 mm	0.02 mm	0.02 mm	0.03 mm
5	Parallelism between centre line of test bar and key way		At 150mm 0.02mm	0.02 mm	0.02 mm	0.02 mm	0.02 mm
6	Parallelism between frame bottom surface and table centre line		At 150mm 0.02mm	0.02 mm	0.02 mm	0.02 mm	0.03 mm
7	Indexing accuracy		±20"	20"	15"	15"	15"
8	Repeatability		4"	4"	4"	4"	4"

★ For ultra precision option: One rank higher accuracies than the above figures are inspected.  
★ Please contact us for the accuracy of the rotary table larger equal to **CNC802** for vertical use.



CNC260B

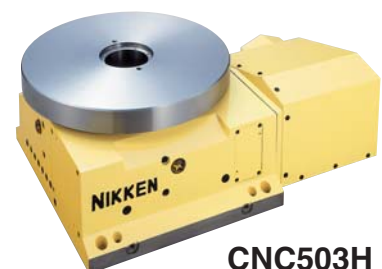


CNC260T

## CNC Rotary Table only for Horizontal Use... Built-in type P.35

No.	Measuring Item	Measuring Method	CNC180 202	CNC260 302	CNC321 401	CNC501 601	CNC802 1000	CNC1200 <sup>*1</sup> 1201	CNC1600 <sup>*1</sup> 2000
1	Parallelism between table surface and frame bottom surface (Concave)		0.015 mm	0.02 mm	0.02 mm	0.02 mm	0.03 mm	0.04 mm	0.05 mm
2	Runout of table surface at horizontal position		0.01 mm	0.015 mm	0.015 mm	0.015 mm	0.03 mm	0.03 mm	0.04 mm
3	Concentricity of centre bore		0.01 mm	0.01 mm	0.01 mm	0.01 mm	0.01 mm	0.01 mm <sup>*1</sup>	0.01 mm <sup>*1</sup>
6	Squareness between frame bottom surface and table centre line		At 150mm 0.02mm	0.02 mm	0.02 mm	0.03 mm	—	—	—
7	Indexing accuracy		±20"	20"	15"	15"	15"	15"	15"
8	Repeatability		4"	4"	4"	4"	4"	4"	4"

★ For ultra precision option: One rank higher accuracies than the above figures are inspected.  
★ Center socket is provided at the centre bore for the table marked \*1. Concentricity of the internal center socket is shown.



CNC503H

## CNC Rotary Table for both of Vertical and Horizontal Use

No.	Measuring Item	Measuring Method	CNC105	CNC180 202	CNC260 302	CNC321 401	CNCB350 450	CNC501 601
1	Parallelism between table surface and frame bottom surface (Concave)		0.015 mm	0.015 mm	0.02 mm	0.02 mm	0.02 mm	0.02 mm
2	Runout of table surface		0.01 mm	0.01 mm	0.015 mm	0.015 mm	0.015 mm	0.02 mm
3	Concentricity of centre bore		0.01 mm	0.01 mm	0.01 mm	0.01 mm	0.01 mm	0.01 mm
4	Squareness of table surface (Minus deviation at upper part is not permitted.)		0.02 mm	0.02 mm	0.02 mm	0.02 mm	0.02 mm	0.03 mm
5	Parallelism between centre line of test bar and key way		At 150mm 0.02 mm	0.02 mm	0.02 mm	0.02 mm	0.02 mm	0.02 mm
6	Parallelism between frame bottom surface and table centre line		At 150mm 0.02 mm	0.02 mm	0.02 mm	0.02 mm	0.02 mm	0.03 mm
7	Indexing accuracy		±30"	±20"	20"	15"	15"	15"
8	Repeatability		4"	4"	4"	4"	4"	4"

★ For ultra precision option: One rank higher accuracies than the above figures are inspected.

★ Please contact us for the accuracy of the rotary table larger equal to **CNC802** for both of vertical and horizontal use.



5AX-230 on 3 Dimensional Measuring Machine

## NST, 5AX- Tilting Rotary Table

No.	Measuring Item	Measuring Method	NST <sup>250</sup> 300	NST500	5AX- <sup>130</sup> 150	5AX-201	5AX-250	5AX- <sup>230</sup> 350	5AX-500	5AX-800	5AX-1200
1	Parallelism between table surface and frame bottom at tilting angle 0° (Concave)		0.02 mm	0.02 mm	0.015 mm	0.015 mm	0.02 mm	0.02 mm	0.03 mm	0.04 mm	0.05 mm
2	Deviation of table surface at tilting angle 0°		0.02 mm	0.02 mm	0.01 mm	0.01 mm	0.02 mm	0.02 mm	0.02 mm	0.03 mm	0.04 mm
3	Deviation of table centre hole at tilting angle 0°		0.01 mm	0.01 mm	0.01 mm	0.01 mm	0.01 mm	0.01 mm	0.01 mm	0.01 mm	0.01 mm*1
4	Deviation of centre line of rotary axis at tilting angle 90°		0.02 mm	0.02 mm	0.02 mm	0.02 mm	0.02 mm	0.02 mm	0.03 mm	0.04 mm	0.05 mm
5	Parallelism between table surface and centre line of guide key at tilting angle 90°		0.02 mm	0.02 mm	0.015 mm	0.015 mm	0.02 mm	0.02 mm	—	—	—
6	Displacement of centre when moving from 0° to 90° at tilting angle 90°		0.02 mm	0.02 mm	0.01 mm	0.015 mm	0.015 mm	0.015 mm	—	—	—
7	Indexing accuracy of rotary axis		Cumulative 20"	20"	±30"	Cumulative 20"	20"	20"	20"	20"	20"
8	Repeatability of rotary axis		4"	4"	4"	4"	4"	4"	4"	4"	4"
9	Indexing accuracy of tilting axis	Cumulative	60"	60"	60"	60"	60"	60"	60"	60"	60"
10	Repeatability of tilting axis	—	—	—	±6"	±6"	±6"	±6"	±6"	±6"	±6"

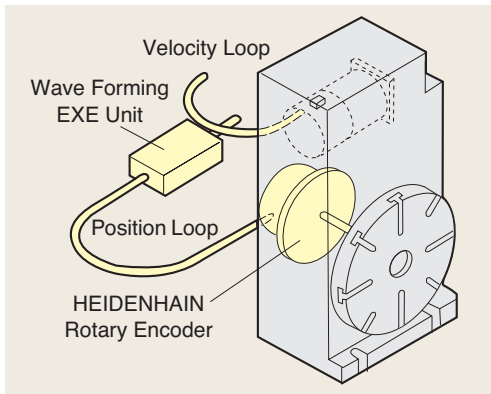
★ For ultra precision option: One rank higher accuracies than the above figures are inspected.

★ Center socket is provided at the centre bore for the table marked \*1. Concentricity of the internal center socket is shown.

# CNC ROTARY TABLE Special Specification 1



## Ultra Precision (True Closed Loop)



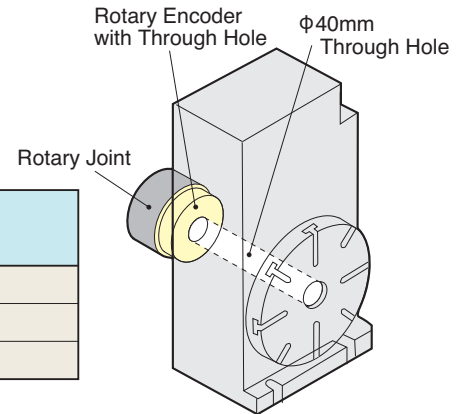
Configuration of Ultra Precision

In ultra precision, 3 grades can be selected for indexing accuracy;  $\pm 3''$ ,  $\pm 5''$  and  $\pm 10''$  (ISO 230 Accuracy Measuring Method).

High resolution rotary encoder is mounted at the back of Rotary Table for detecting positioning feedback, to realize true closed loop. (Position is detected on the rotating table itself.)

In case indexing unit of  $1^\circ$  or very high rigidity is required, please select Hirth Coupling Index **NSVZ**, **NSVX** series table.

☞ P.33



The rotary table with **RCN8390** or **RON886** has  $\phi 40$ mm through hole, and the rotary joint can be mounted.

## Rotary Encoder and Wave Forming Unit for CNC Rotary Table

Table Model	Indexing Accuracy	$\pm 3''$	$\pm 5''$
<b>CNC105, 180, 202</b>		—	RON285, IBV101
<b>CNC260, 302</b>		RON886, IBV102	RON285, IBV101
<b>CNC321~2000</b>		RON886, IBV102	RON786, IBV101

★ EXE unit and cables are not included in ultra precision option. Please order separately.

★ In case of FANUC, the encoder with FANUC absolute serial interface (**RCN2390**, **RCN8390** ( $\phi 60$  or  $\phi 100$  hole)) is recommended. In this case, EXE unit is not necessary.

★ Air purge of the encoder inside is available as an option for water proof. Please contact us.

## Rotary Encoder and Wave Forming Unit for 5AX- Tilting Rotary Table

Table Model	Indexing Accuracy	$\pm 5''$	$\pm 10''$
<b>5AX-130, 201, 230, 250</b>	Rotary	RON285, IBV101	—
	Tilting	—	RON285, IBV101
<b>5AX-350</b>	Rotary	RON285, IBV101	—
	Tilting	—	RON285, IBV101
<b>5AX-550, 800</b>	Rotary	RON786, IBV101	—
	Tilting	—	RON786, IBV101



**Higher indexing accuracy (Rotary:  $\pm 3$  sec., Tilting:  $\pm 5$  sec.) is available. Please contact us.**

## ISO 230-2 1997 (JIS B 6192-1999)

Accuracy Measuring Method

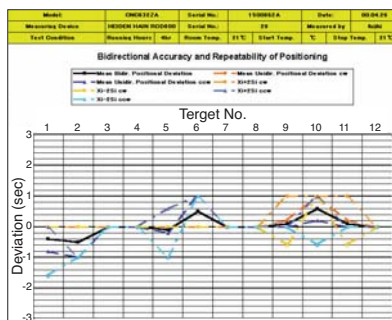
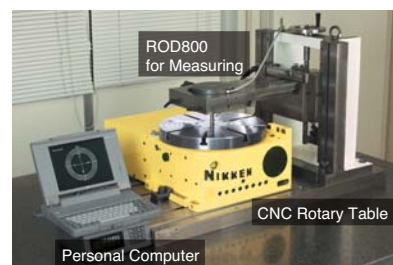
Rotating Axis:  $30.2^\circ \times 12$  points

Tilting Axis:  $15.2^\circ \times 8$  points

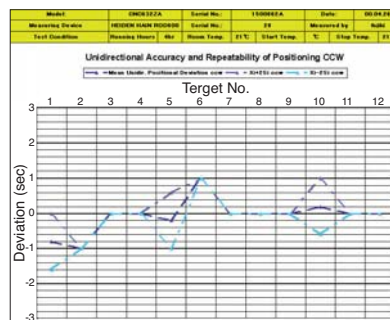
Continually repeating 5 times rotation of CW/CCW, measuring are to be done at above-mentioned points.

And, bidirectional accuracy of positioning, bidirectional repeatability of positioning, unidirectional accuracy of positioning, unidirectional repeatability of positioning etc. are calculated.

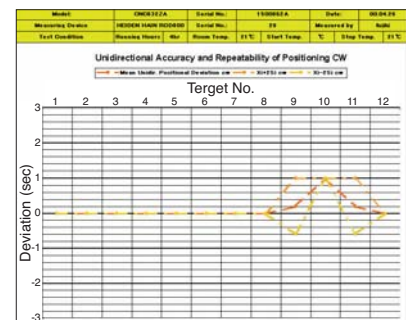
Test data sheet is available in English.



Bidirectional Accuracy and Repeatability of Positioning



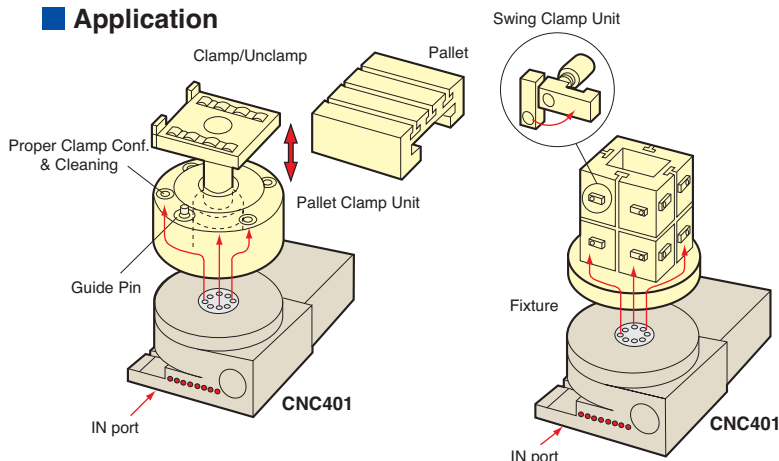
Unidirectional Accuracy and Repeatability of Positioning



## Rotary Joint

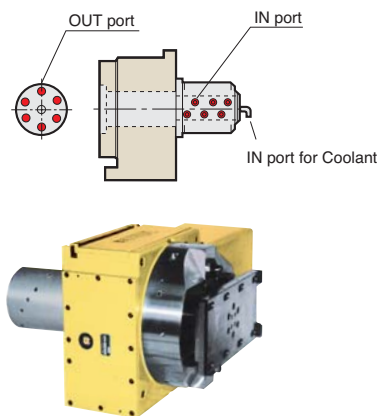
There are 3 types of the rotary joint such as cylinder type, flange plate type and built-in type. Rotary joint is used for clamp/unclamp of the work piece, confirmation of proper clamp, cleaning, coolant etc. 3 types of rotary joint are available. The fine cutting swarf may come through the filter into the coolant port, therefore the coolant port is recommended to be separated. (Refer cylinder type rotary joint)

## Application



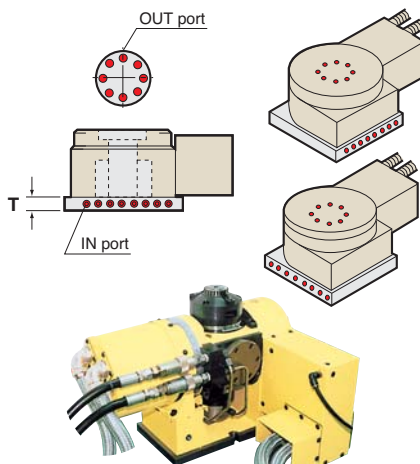
### 1. Cylinder type Rotary Joint

Retrofitting to standard CNC rotary table is possible.



### 2. Flange Plate type Rotary Joint

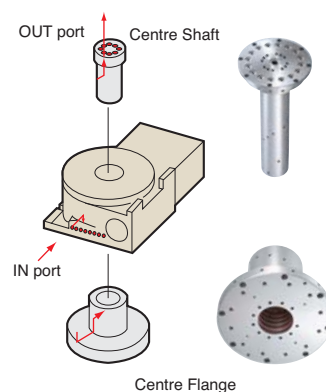
IN ports position can be changed at any angle of 360°. The every position which causes no interference against M/C can be selected.



### 3. Built-in type Rotary Joint

JAPAN : PAT.

For **CNC321,401,501,601,802,400H,503H**, 8 IN ports are arranged on the table body. Centre flange and centre shaft are as an option.



Even the number of IN ports is limited, rotary joint can be installed for the rotary table with the rotary encoder for ultra precision. Please contact us.

Code No.	Cylinder type			Flange Plate type			Built-in type			
	MAX.No. of Ports	MAX.No. of Ports	Tmm	MAX.No. of Ports	MAX.No. of Ports	Tmm	MAX.No. of Ports	MAX.No. of Ports	Tmm	
<b>CNC 105</b>	4+1*1	4	25	—	—	—	<b>5AX-130,150</b>	2 (4)	—	—
<b>180,202</b>	6+1*1	6	25	—	—	—	<b>201</b>	4 (6)	—	4*2
<b>260,302</b>	10+1*1	11 (8*6)	60 (-*6)	—	—	—	<b>250</b>	—	—	3*3
<b>321,401, 401H</b>	12+1*1	—	—	8+1*1	—	—	<b>350</b>	—	—	6+1*4
<b>B350</b>	16+1*1	—	—	—	—	—	<b>550</b>	10*5	—	—
<b>B450</b>	20+1*1	—	—	—	—	—	<b>800</b>	—	—	6
<b>503H</b>	12+1*1	—	—	12+1*1	—	—	<b>DD250-</b>	—	6	30
<b>501,601</b>	14+1*1	15	—	8+1*1	—	—	<b>400-</b>	—	8	30
<b>802</b>	16+1*1	—	—	10+1*1	—	—	<b>5AX-DD200A,B</b>	—	4	—
<b>NSVZ 180</b>	6+1*1	5	25	—	—	—				
<b>300</b>	8+1*1	6	30	—	—	—				
<b>400,500</b>	12+1*1	13	50	—	—	—				
<b>TAT 105,170</b>	6+1*1	2	25	—	—	—				
<b>200,250</b>	9+1*1	7	30	—	—	—				
<b>320,400, 500</b>	14+1*1	7	35	—	—	—				

- ★ ( ) : MAX No. of high column table.
- ★ \*1: +1 port is the port located in the centre hole (for coolant).
- ★ \*2: 4 reserve ports are provided on **5AX-201**.
- ★ \*3: 3 reserve ports are provided on **5AX-250** and 2 external ports are available.
- ★ \*4: 6 reserve ports are provided on **5AX-350**. No additional port is available.
- ★ \*5: 4 reserve ports are provided on **5AX-550** as standard, and the additional 6 ports are available.
- ★ \*6: MAX.8 ports for **CNC260B, 302B**.

### Caution of IN port

- When the air is supplied for all IN ports, please contact us.
- Please do not supply the different pressure of the air in the IN ports next each other.
- Please make sure that the line filter should be provided for pneumatic supply use in order to avoid swarf and water ingress for rust problem.
- This is not avoidable that the oil of the hydraulic port may be leaked to the next air port for the long time use, due to the characteristic of the seal. Please do not assign the air port next to the hydraulic port as much as possible.
- The rotary joint must be specially treated to prevent from the rust, when using the glycol solution for the operating fluid. Please inform us when ordering.
- When the rotary joint is designed at your side, please select the low friction type seal. Then, please check the rotary table movement after installation of your rotary joint, not to over load.

# CNC ROTARY TABLE Special Specification 3



## Waterproof specifications

- Mechanical parts of the table are perfectly sealed. For water resistance to electric parts such as cables, the hard-wired type connection on the motor cover is available as an option.
- For the rotary table with pneumatic brake, air purge is arranged inside the motor cover as standard.
- In case of the table which with  $\alpha$ 21 controller, the hard-wired type connection on the rotary table side and hating connector fitting on the controller side, however, the hating connector fitting on the rotary table side is also available as an option.
- For  $\alpha$ 21PW controller, water resistant connector type cables are supplied as standard.

For all CNC rotary tables,  $\Delta$  mark obtained parts or equivalent and  $\text{C}$  marked electric parts are used, ensuring high safety.  
 $\Delta$  : Safety approval mark by TÜV RHEINLAND.  
 $\text{C}$  : Safety mark required for marketing in Europe from '95.



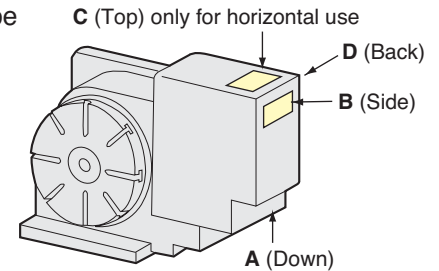
Cable Direct Out type



Cable with Blade (Option)  
Standard Length: 5m



Hating Connector type



## Position & Direction of Connecting Cable

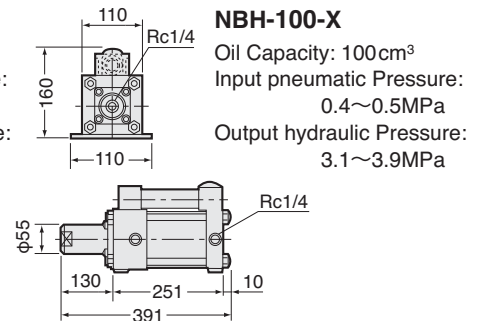
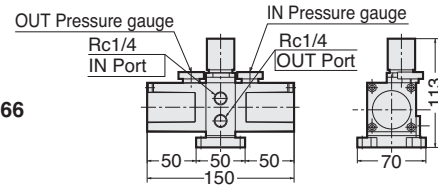
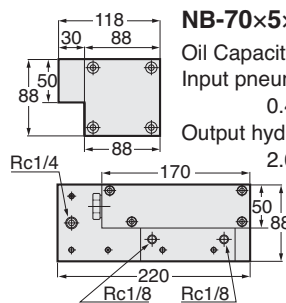
The standard of the cable connecting direction is B or D. A or C is possible on demand.

## Air Intensifying Booster (Max. Output: 0.7MPa)

The air pressure can be double by Air Intensifying Booster. This is suitable for tables with the Double Intensifying Braking System such as the tilting axis of 5AX-130. [P.66](#)

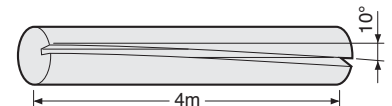
## Air Hydraulic Booster

Please order an air hydraulic unit for the machine without hydraulic source.  
 Applicable for **CNC260, CNC302 : NB-70×5×30**  
**CNC321~CNC801 : NBH-100-X**  
 Please ask for the layout of the booster.



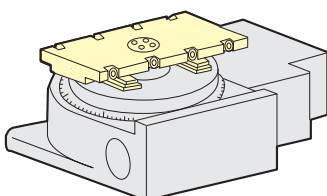
## Ultra Heavy Duty CNC Rotary Table

In such lead milling as right hand, the movement of rotating axis is very small in relation to the movement of X axis, servo control will be very difficult. If the cutting conditions and surface finish etc. can not be satisfied with standard CNC rotary table, Ultra Heavy Duty CNC Rotary Table is recommended. **(Cutting capability is 5 times of the standard type.)**



## Built-in Pallet Clamp System

Available to CNC rotary table and 5AX-tilting rotary table. Very suitable to NC special purpose machine and Horizontal M/C as built-in B axis table.



Lifting type Pallet Clamp Unit

## Special Color

Please order with the color sample or Munsell Color No.



Pallet Clamp Unit  
with Automatic Coupler



# Assessment of CNC ROTARY TABLE



## Assessment for Reliability & Quality.

### Over Load Test

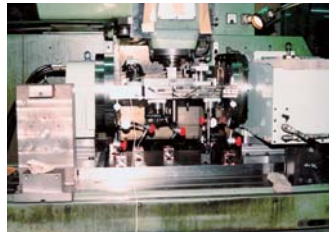
The wearing of the worm wheel is very small under very severe testing condition.



### Brake Torque Test

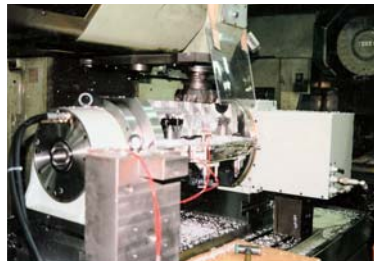


### Rigidity Test



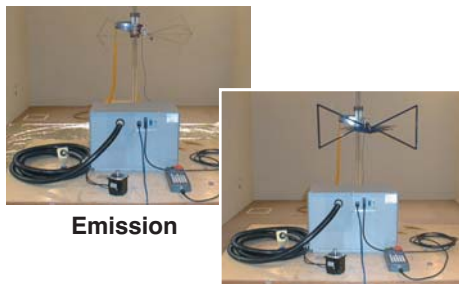
### Cutting Stability Test

The micro vibration during machining or the surface finish are measured.



### EMC Test

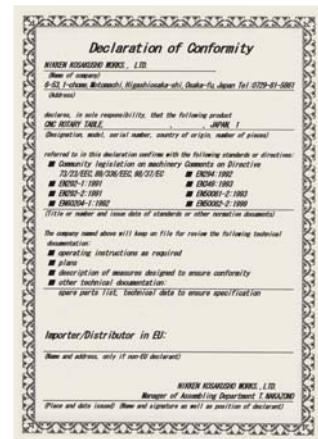
Electromagnetic Compatibility Test



Emission

Immunity

### Water Proof Test



Declaration of Conformity

### Load Test for Large Rotary Table



5AX-800

2 units of **CNC501** (940Kg) are used for the load on **5AX-800**.



5AX-1200

**CNC802** (1100Kg) is used for the load on **5AX-1200**.



Counter balance

5AX-1200

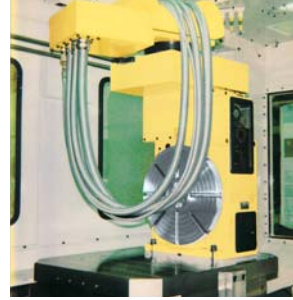
Testing of **5AX-1200** with counter balance weight

# CNC ROTARY TABLE Special Specification 4



NIKKEN CNC rotary tables are used in various kinds of world wide applications. Please contact with us with the dimension of your work piece and construction of the jig fixture etc. We will recommend you the best application.

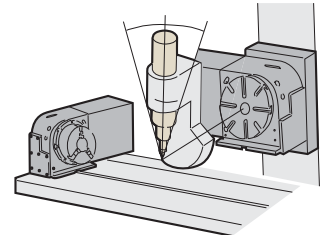
## ■ Combination with Pallet Changer



2 units of CNC rotary tables are used on the TAPPING CENTER with swing type pallet changer.



## ■ Combination of CNC Rotary Tables



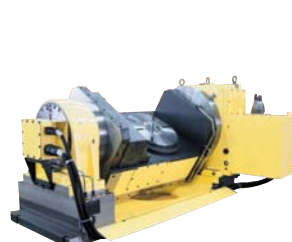
Machining of turbine wheel to use 2 units of CNC rotary tables, one for the swing axis of the HF motor and the other for the rotary axis of the work piece



5AX-400FA-RJ8-800/150



5AX-500MA-RJ10-900/100



5AX-321FA



CNC180 + TAT105 + CNCZ503

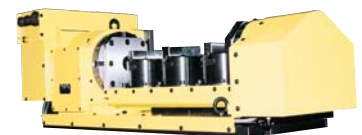
## ■ Application of CNC Rotary Table with Support Table



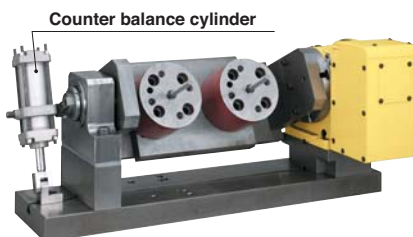
CNC170 + TAT105



CNC601,3m Jig Block & TAT500



3 sets of power chucks are used for work clamping.

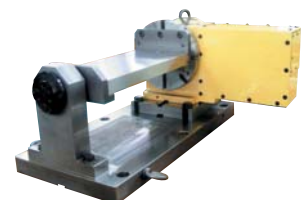


Counter balance cylinder

In case of the application with the support table, unbalancing load used to be large. The counter balance cylinder is highly recommended. P.6



Synchronous Rotation by CNC401 X 2units



CNC170 + Special Support Table

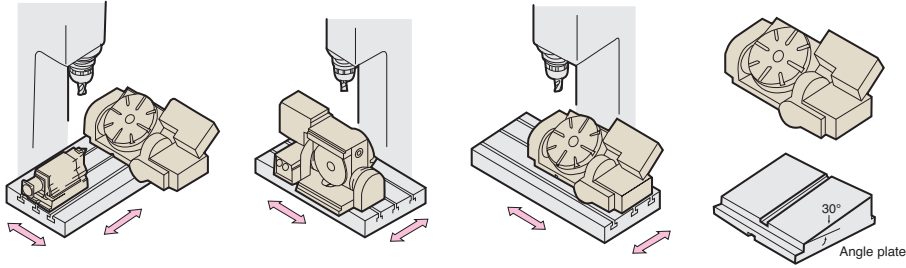
# CNC ROTARY TABLE Special Specification 5



## Example of 5AX Rotary Table location on M/C

There are various ways of arrangement.

- ▼ Tail Stock is used together.
- ▼ Y axis stroke of the M/C is not enough
- ▼ Y axis stroke is enough
- ▼ Tilting range is 30-135

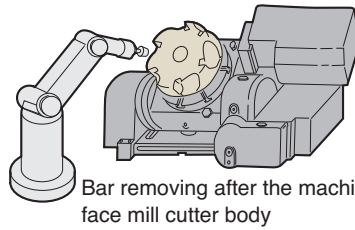


**5AX-300**  
Example on the angle base (60°)

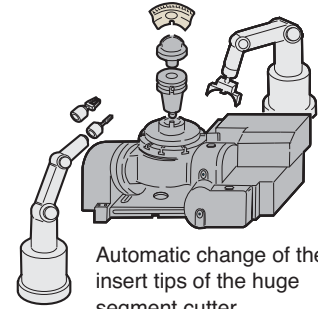
## Application of 5AX-Table



**5AX-500** with square table



Bar removing after the machining of face mill cutter body

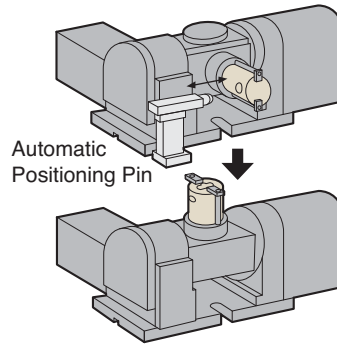
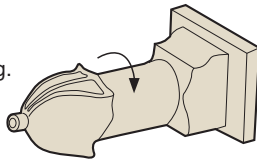


Automatic change of the insert tips of the huge segment cutter

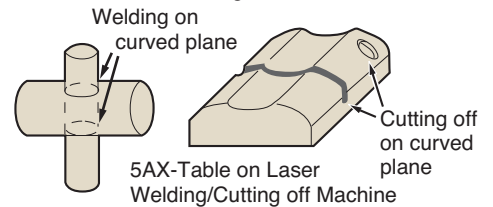
**5AX-150** for 4th and 5th axes tilting rotary table on special grinding centre



Simultaneous 3 axes control of X, Z & A axis instead of turning.



Automatic Positioning Pin



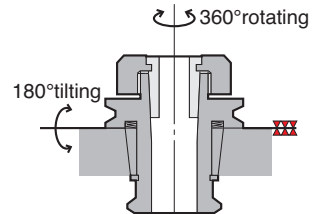
Welding on curved plane

Cutting off on curved plane

**5AX-Table** on Laser Welding/Cutting off Machine

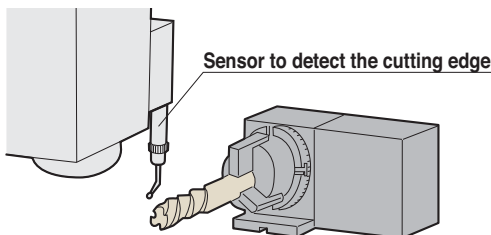
1. The work piece is exchanged by ROBOT, the positioning pin goes forward, then the work piece is clamped at the tilting axis = 90°.
2. The positioning pin goes backward, the tilting axis moves to 0°, then the machining starts.

The tilting movement is used only for automatic work piece exchange



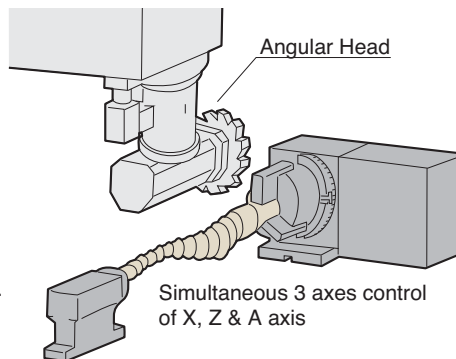
**5AX-Multi Spindle Table + Jig Holder** with Through Hole

## Other Application



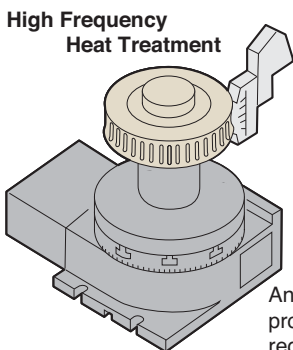
Sensor to detect the cutting edge

Work piece (Cutter) is exchanged by ROBOT, and the cutting edge will be detected automatically.



Angular Head

Simultaneous 3 axes control of X, Z & A axis



**High Frequency Heat Treatment**

Anti noise process is required.

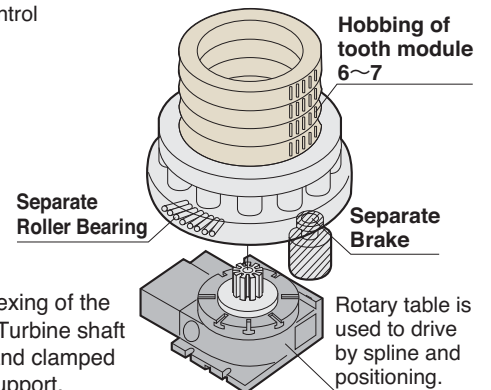


Roller Support

**CNC1201** Indexing of the turbine shaft. Turbine shaft is supported and clamped by the roller support.



**CNC1800 & Support Branch**  
Indexing/ clamping of the turbine disk



**Hobbing of tooth module 6~7**

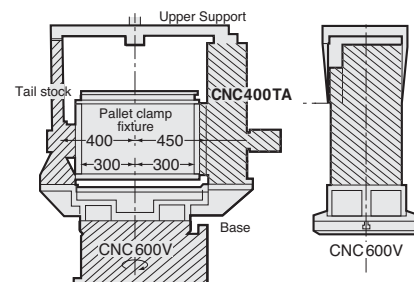
Separate Roller Bearing

Separate Brake

Rotary table is used to drive by spline and positioning.

## Conditions of CNC Rotary Table when being used to CNC Special Purpose Machine

Not only indexing accuracy, the following conditions must be also filled for continuous operation of 24 hours. Namely, Load calculation, Indexing time, Durability etc. And the overseas service branches and after service ability are also important.



### ① Load Calculation

In case using conditions are beyond the specification of CNC rotary table, please inform us the work piece, jig fixtures, required indexing time etc. Then, we will calculate the load of your application, and select the suitable CNC rotary table. When such jig fixture and work as right hand are to be rotated on CNC rotary table, we analyze into ①~⑤ elements, and calculate as per the list shown at right hand side.

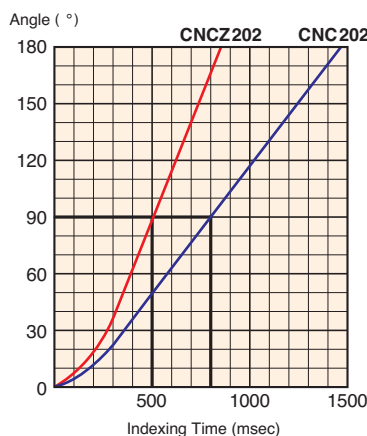
No.	Shape	Quantity	Approx. Weight (Kg)	Approx. GD <sup>2</sup> (GD <sup>2</sup> /4)Kgm <sup>2</sup>
①	CNC400T Eccentricity: 450mm	1	260	59
②	Tailstock Eccentricity: 120mm	1	80	14
③	Base	1	11	10
④	Upper Support Parts	1	30	2
⑤	Pallet Clamp Fixture Eccentricity: 120mm	1	80	6
Total			560	91

### ② Indexing Time Comparison

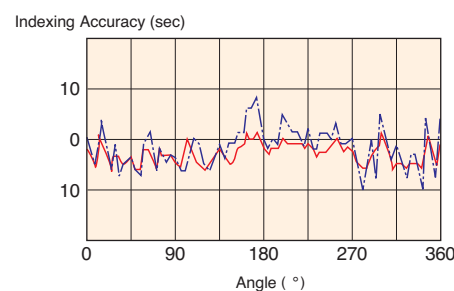
Indexing Time = Acceleration Time + Rapid Positioning Time + Deceleration Time.  
MAX. moving angle is 180°. Therefore, not only rapid positioning time, but also acceleration / deceleration characteristics is very important. The graph at right hand side shows that **CNCZ202** (high speed), with it's excellent acceleration / deceleration capability, gives a very substantial time saving of approximately 300 msec. on this 90° movement comparing with **CNC202** (standard).

**CNCZ202** : 500 msec.  
**CNC 202** : 800 msec.

Item	Rapid Positioning Speed	Acceleration/Deceleration Time Constant
— (Red)	44.4min <sup>-1</sup>	150msec
— (Blue)	22.2min <sup>-1</sup>	100msec



Item	Using Years	Indexing accuracy
— (Red)	At installation	Cumulated 10sec
— (Blue)	After 7 years	Cumulated 17sec



### ③ Durability

In 24 hours continuous operation, durability is one of the most important conditions. Thanks to Carbide Worm System, NIKKEN CNC rotary table ensures highest anti wearing nature even at the severest load conditions with high speed indexing. The graph at right hand side shows the worm wheel & worm screw and accuracy inspection of the table having been used for 7 years on CNC special purpose machine in production line of automobile parts plant.



Worm System after 7 years used.

### ④ World Wide Service Network

Even for the perfect product, an unexpected accident can not be avoided. Please choose the NIKKEN CNC rotary table not only the completeness of the product, but also the world wide service network. [P.77~P.82](#)

## SI Unit & Gravity Unit

SI is the abbreviation of "Systeme International d'Unites".

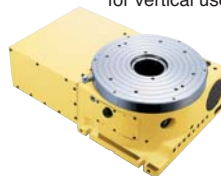
Item	SI Unit	Gravity Unit	Conversion
Clamping torque	N·m	kgf·m	1kgf·m=9.8N·m
Table Inertia at Motor Shaft *1	$(\frac{GD^2}{4})\text{kg}\cdot\text{m}^2 \times 10^{-3}$	kg cm sec <sup>2</sup>	1kg cm sec <sup>2</sup> =10.2 $\times(\frac{GD^2}{4})\text{kg}\cdot\text{m}^2$
MAX. Motor Rotation Speed	min <sup>-1</sup>	rpm	1rpm=1min <sup>-1</sup>
MAX. Table Rotation Speed			
MAX. Thrust Load applicable on the Table	N	kgf	1kgf=9.8N
	N·m	kgf·m	1kgf·m=9.8N·m
MAX. Work Inertia *	$(\frac{GD^2}{4})\text{kg}\cdot\text{m}^2$	kg cm sec <sup>2</sup>	1kg cm sec <sup>2</sup> =10.2 $\times(\frac{GD^2}{4})\text{kg}\cdot\text{m}^2$
Driving Torque	N·m	kgf·m	1kgf·m=9.8N·m
Air/Hydraulic Pressure	MPa	kgf/cm <sup>2</sup>	1kgf/cm <sup>2</sup> =0.098MPa

★ \*1 The unit of inertia is expressed in GD<sup>2</sup>.

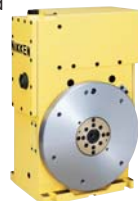
## Specification of the rotary table to be used on the special purpose machines.

- Custom made on the Table Face Plate
  - Drilled hole, tapped hole, or dwell pin hole etc.
  - Without T-slot or with T-slot
  - Additional process at centre hole
- The location of the Oil Sight Glass, Oil Supply Port and Drain Port can be changed.
- How to be mounted on the Machine
  - U-groove
  - Additional tapped holes on the backside
  - Shift the guide key position
- Modification of the Motor Cover
- Rotary Joint [P.54](#)
- Built-In Pallet Clamp System [P.55](#)
- Special Color [P.55](#)
  - Please order with the color sample or Munsell Color No.

When rotary table is used for horizontal use, there is no portion of the table body to be clamped for vertical use.



**CNC401 without T slot for horizontal use**



**CNC302T without T slot**

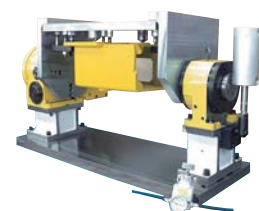


**CNC202L without T slot**



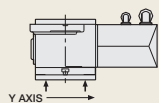
## Selection of the CNC rotary table

- The support table is basically used in case of vertical application.
- The machining operation is generally light cut on aluminium materials, however, if the fixture or the component is large size, please make sure that the fixture inertia is within the MAX. work inertia.
- If the unbalance load is too big, it will affect on not only the indexing accuracy but also the durability. Please make sure the unbalance load will be within the following figures.  
**CNC105 : 10Nm, CNC180, 202 : 20Nm, CNC260, 302 : 30Nm**
- In case of the unbalance load is large,
  - The high speed Z series rotary table is not suitable, please use standard rotary table.
  - Please installing the balance cylinder or counter balance. [P.6](#)
  - Please advise us the details of the component, fig fixture, indexing time etc. prior to your order, and we will make a calculation of the load and select the best suitable rotary table for your application.
- If the huge amount of coolant has to be applied, we could prepare air purge (with pneumatic pressure of 0.03MPa) on the CNC rotary table body as an option. Please contact us the details.

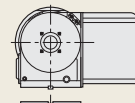


## Check point for trunnion fixture

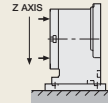
- ① When installing the table onto the sub-base, measure and check as follows.



Parallelism between table & sub-base is recommended within 0.01mm

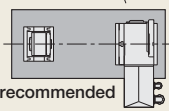


Difference between table centre and sub-base centre is recommended within 0.02mm

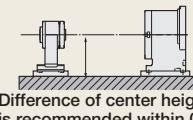


Squareness of table is recommended within 0.02mm

- ② Install the table & support table onto the M/C as follows.

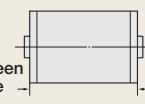


Centre lines are recommended within 0.02mm



Difference of center height is recommended within 0.01mm

- ③ Trunion fixture is recommended to be aligned as follows.



Squareness between center line & these faces is important

Centre of both side are recommended within 0.01mm



Squareness is important



## Caution

- Always be careful not to inflict personal injury on any shop objects when unpacking this equipment.
- Caution should always be used when lifting this product. Especially when using lifting equipment. Manual lifting of this product may cause serious back injury. Always use safe lifting techniques.
- Install the rotary table on a well ventilated place hidden from direct sunlight, on a place not exposed to corrosive gas such as sulfuric acid and hydrochloric acid. Do not install the rotary table on a place with excessive high/low temperature. (Normal operating temperature: 5°C~40°C)
- Under the lower temperature condition, please warm the rotary table up just after power on. Or, please use lighter lubrication oil as another solution.
- Only the specified power voltage should be used. Incorrect power supply may result in fire.
- Always power off the machine before attempting any installation and wiring work. Failure to do this may result in serious personal injury or electric shock.
- The machine on which CNC rotary table is installed should have a complete cover or splash guard.
- When installing this product onto a machine tool, always pay special attention to the location of cables, hoses and hydraulic tanks (if used), to check for interference.
- Please make sure that all cables and hoses are sufficiently long to allow full axis travel.
- Always ensure that there is no interference with the CNC rotary table or tailstock unit of the ATC (Automatic Tool Change) position.
- Always ensure safe cable runs according to the instruction manual in order not to interfere with the machine operation. It is dangerous if the cables become entangled with the machine table or spindle unit.
- Always check the parallelism and squareness of the table to the machine axes and fix to the machine table using the fixings provided.
- Please follow the instruction manual for installation, wiring of cables and hoses. Failure to connect wiring correctly may cause fire or a serious accident.
- This table has been given a waterproof treatment, however if ingress of coolant should occur, stop using the table immediately. Failure to do so may result in the unit catching fire or causing serious electric malfunction.
- Always ensure that pneumatic or hydraulic hoses are connected correctly.
- Always keep the air filter clean to prevent water and dirt ingress from the air supply.
- Please ensure that the hydraulic pressure flows constantly on the pump line at brake clamp in the save energy type hydraulic circuit.
- Please use CNC rotary table within the specification. Exceeding the specification may cause defective components and irreparable damage. Please contact us in case of the beyond the specification before ordering. [P.59](#)
- Never modify the table by yourself without previous agreement of NIKKEN
- Never to touch any moving parts. Failure to follow this instruction may result in serious personal injury.
- For the rotary table with the NIKKEN controller, firstly turn the power of NIKKEN controller off, then turn the power of main M/C off at the end of operation.
- Always remove swarf from the table after use. Long term operation without cleaning may cause damage to the internal mechanism.
- Always change the lubrication oil annually to prevent the gear wear.
- If a collision occurs with the table, power off the machine controller immediately and contact your distributor for repair.
- Always stop using the table if unusual noises are heard or the slackness or deflection of work piece and jig fixture are found. Irreparable damage may be happened. Please contact with your distributor for repair.

# NIKKEN CONTROLLER Specification 1



## Minimum Command Increment: 0.001° or 1sec.

α21 controller can drive all models of NIKKEN CNC rotary table.

## Single M signal provides Various Automatic Operation.

Any unequal dividing, equal dividing, arc cutting, lead cutting etc. can be done very easily.

## RS232C Interface is provided as standard.

Block data/ parameter data can be up loaded/down loaded through RS232C interface. Moreover when the direct angle command interface is used, all program and management can be done on M/C side. **JAPAN PAT.**

## Up Grade of Water Proof Characteristic EMC Assessment P.56

The direct out type connection is applied for all models of CNC rotary table, and the EMC assessment is satisfied as the total system.

## Digital Servo System & Absolute Encoder

Very excellent acceleration/deceleration characteristics, the powered up torque and the best suited servo parameter realize the high quality and long life.

after Power ON or after releasing the emergency stop condition is not necessary. \*

## Plenty of Optional Functions

True Closed Loop, Manual Pulse Generator, M Function (Input: 5/ Output: 5), External N Number Search, External Position Display, External Power ON/OFF, Pitch Error Compensation

## More than 25,000 sets working in the field.

This fact ensures the highest reliability.

\* : The operation to establish the coordinate system is required at once, when turning the POWER ON at first time just after connecting the cable. Please refer P.64



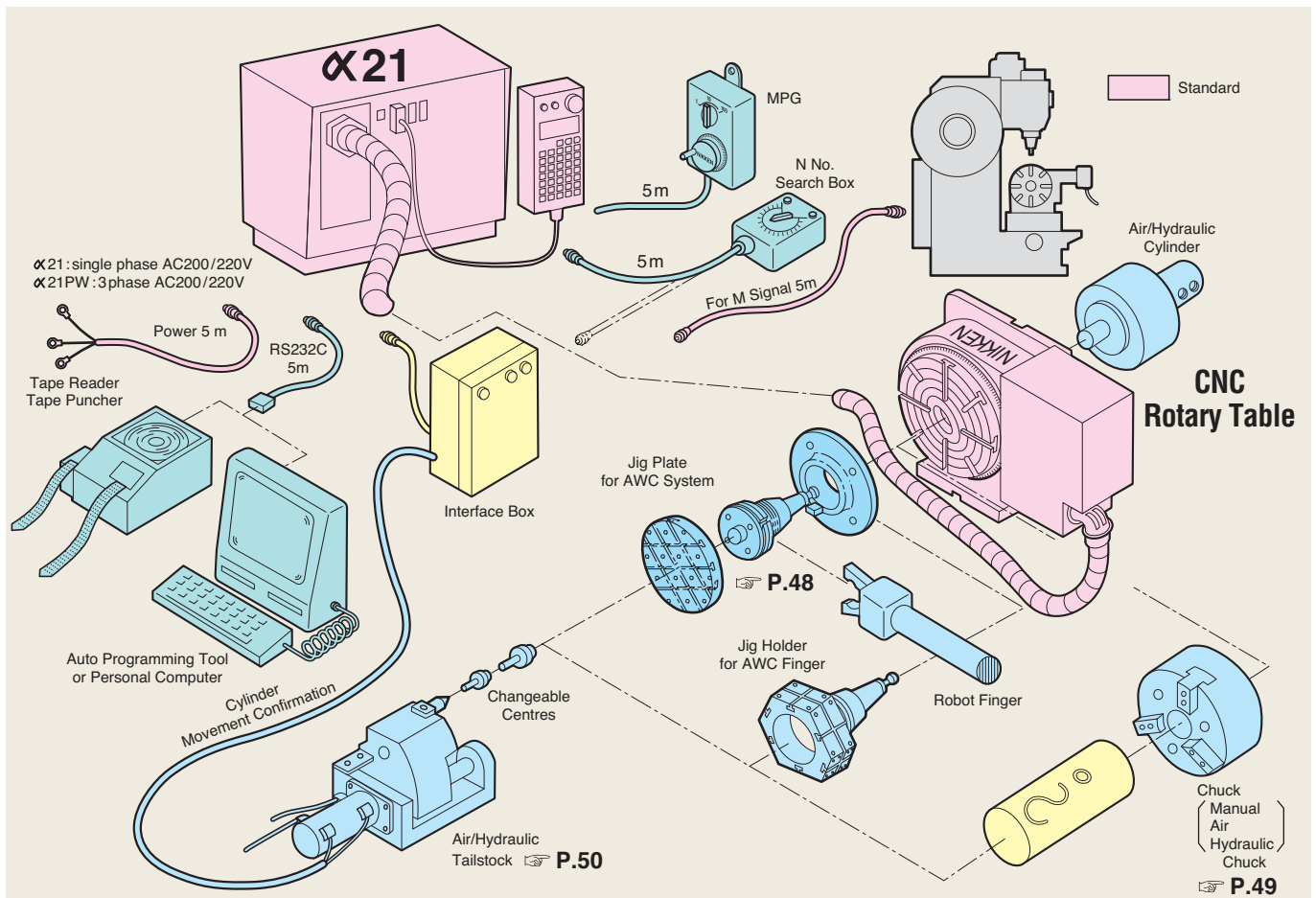
α 21 controller  
 • Standard (400W, 750W)  
 300×280×285 10kg  
 • Single Phase AC200/220V



α 21 PW controller  
 • Power up (1.3KW, 1.8KW)  
 540×360×400 28kg  
 • 3 phase AC200/220V



α 21 controller for larger capacity  
 • (2.7KW, 4.4KW and 11kW) is available.  
 • 3 phase AC200/220V



## Main Specification of Controller ( **NEW** NIKKEN- $\alpha$ 21 controller)

The operation, programming and the interface to M/C are interchangeable with the old NIKKEN controllers ( $\alpha$ 21,  $\alpha$ , 8800AX).

Item	Specification	Remarks
MIN. Increment	0.001° or 1"	Free Selection
MAX. Programmable Angle	$\pm 9999$ rotation, $\pm 999.999^\circ$ & $\pm 999^\circ 59' 59''$	Free Selection
MAX. Equal Dividing	2~9999 equal dividing	
Program Capacity	1000 Blocks	N000~N999
Input System	MDI Key Board, Pendant type	5 years memory
Programming System	Combined use of Incremental/Absolute	Free Selection of G91 / G90
Zero Return	Machine Zero Position/Work Zero Position	can be commanded from outside.
Manual Feed	Rapid Feed/Fine Feed/Step Feed/Continuous Feed	
Uni-directional Positioning	Uni-directional Positioning can be done to eliminate the mechanical backlash.	G14
Emergency Stop	Whole system stops	can be commanded from outside.
Feed Hold	Table rotation temporarily stops.	can be commanded from outside.
Jump Function	Jump to sub program etc.	
Repeating Function	By specifying start No. and final No., multiple sequence are repeated.	
Buffer Function	Reading next block, and execute job without stop.	Useful for lead cutting etc.
Dry Run	Table always rotates in rapid feed for checking.	
Key Lock Function	Even if operation button is pressed by mistake, such command is neglected for safety.	
Preparatory Function	Dwell, Clamping/Unclamping, Lead Cutting...	G01~G92
G1 Code, G2 Code	2 kind of G codes can be entered in one block.	
Block Data display	At programming, previous block data or next block data are displayed.	↑ ↓
RS232C Interface	Block data/ parameter data can be up loaded/down loaded through RS232C interface.	
	Direct angle command interface enables that the positioning can be commanded from M/C, and all management of the program can be done on M/C.	Custom macro is necessary on M/C.
	RS232C automatic loading function enables that successive block data can be down loaded from M/C and all management of the program can be done only on M/C.	Custom macro is necessary on M/C.
Software Limit Function	$\pm$ stroke limit values can be set by parameter.	
Over Travel Detection Function	Over travel detection zone can be set at outside of software limit by using control circuit, and the CNC rotary table can be protected not to exceed safety zone.	Standard for 5AX- type tilting axis
Alarm No. Automatic Indication Function	When alarm is detected, controller automatically goes to diagnosis mode and Alarm No. is displayed.	When duplicated, it flickers every 2 sec.
Alarm Out	Alarm condition of $\alpha$ 21 can be sent to M/C	Option
Emergency Stop Out	Emergency stop condition of $\alpha$ 21 can be sent to M/C.	
Self Diagnosis Function	Inside situations of controller can be seen.	
Modal G Code Flicker Function	All G codes used in program are indicated in flickering.	Every 2 sec.
Pitch Error Compensation Function	Rotary axis: 15° unit, Tilting axis: 5° unit	Option
Feed Rate Override	5~200%, 999% (Rapid feed)	$\pm 5\%$
Input Signals	1 kind of Auxiliary Function. (Automatic operation can be done by only one M signal.)	With or without contact signal *1
Output Signal	1 Block Finish signal, Work Zero Position Signal, Alarm Out Signal *2	Ask Time Chart
Servo Motor	AC servo motor with serial encoder	
Input Power	$\alpha$ 21 : Single phase AC200~220V, 50Hz / 60Hz	400W : 1.0KVA , 750W : 1.3KVA
	$\alpha$ 21 PW : 3 phase AC200~220V, 50Hz / 60Hz	1,300W : 1.4KVA , 1,800W : 1.8KVA

\* 1: M signal of M/C is valid only the block without DEN (Distribution End).

\* 2: Work Zero Position Signal and Alarm Out Signal are optional signals.

## OPTIONAL SPECIFICATION

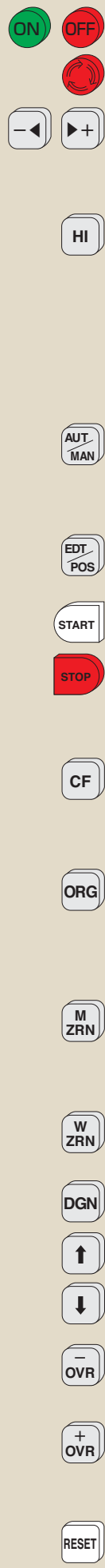
- |  |   |   |  |   |
|--|---|---|--|---|
| <p><b>1 True Closed Loop</b></p> <p>This is to be used for ultra precision rotary table.</p>                     | <p><b>2 Manual pulse generator (X1, X10, X100)</b></p> <p>This pulse generator enables the table to be rotate or tilted by manual operation on every 0.001~0.1° unit.</p> | <p><b>3 Five M functions</b></p> <p>Control and confirmation of other actuator (hydraulic tailstock, coolant controller, robot etc.) can be done from <math>\alpha</math> 21 side. <math>\alpha</math> 21 for AWC, this is included as standard.</p>  | <p><b>4 External N Number Search Function</b></p> <p>When plural programs are entered in 1000 blocks. Desired N number can be searched from outside (applicable also to FMS line).</p> | <p><b>5 External Position Display</b></p> <p>When the direct angle command interface is used, this display will be used near M/C MDI panel.</p> |
| <p><b>6 External Power ON/OFF</b></p> <p>Interface to perform Power ON/OFF by external circuit is available.</p> | <p><b>7 Pitch Error Compensation</b></p> <p>Rotary Axis:<br/>by 15° unit <math>\times</math> 24 points<br/>Tilting Axis:<br/>by 5° unit <math>\times</math> 24 points</p> | <p><b>8 Output Signal *2</b></p> <p>Work Zero position signal is the signal set to ON while the CNC rotary table is in the work zero position. Alarm Out signal is the signal set to ON when <math>\alpha</math> 21 is in alarm condition. These signals can be used for interlocking function.</p> | <p><b>9 Harting Connector Type...Only for <math>\alpha</math> 21</b></p> <p>Harting Connector can be corresponded to the CNC Rotary Table side.</p>                                    |   |

# Explanation of the PENDANT 1



- ① Power Switch
- ② Emergency Stop Button
- ③④ Manual Jog Button
- ⑤ High Speed Button
- ⑥ Auto/Manual Select Switch
- ⑦ Edit/Current Position Select Switch
- ⑧ Start Button
- ⑨ Stop Button
- ⑩ Continuous Feed Button
- ⑪ Original Point Set Button
- ⑫ Machine Zero Return Button
- ⑬ Work Zero Return Button
- ⑭ Diagnosis Button
- ⑮ Increment/Decrement of Block No.
- ⑯ Feed Rate Override Button
- ⑰ Reset Key

- **READY** ..... Turned ON when input power is supplied.
- **COM.** ..... Turned ON while  $\alpha 21$  main unit and the pendant are communicating.
- **ALARM** ..... Turned ON when  $\alpha 21$  is in alarm condition.
- **COM. ALARM** ..... Turned ON when communication time out error occurs between  $\alpha 21$  main unit and the pendant.



## ① Power Switch

## ② Emergency Stop Button

## ③④ Manual Jog Button

▶ + Clockwise, ◀ Counter clockwise.

While this button is being depressed, the table continually rotates slowly. When this button is depressed once, the table steps by 0.001°(1").

## ⑤ High Speed Button

When this button is depressed together with ③ or ④, the table rotates in rapid feed.

When jog ① while depressing ⑤, table moves as following;

Gear Ratio	Table Movement	Gear Ratio	Table Movement
1 : 720	0.5°	1 : 90	4.0°
1 : 360	1.0°	1 : 60	6.0°
1 : 180	2.0°	1 : 45	8.0°
1 : 120	3.0°		

## ⑥ Auto/Manual Select Switch

When this button is turn to Manual, all buttons are workable.

When this button is turn to Auto, all other buttons except ①, ②, ⑥, ⑧, ⑨, ⑭, ⑯, ⑰ are ineffective.

## ⑦ Edit/Current Position Select Switch

On  $\theta$  of ⑩, programming or present position is displayed alternatively.

## ⑧ Start Button

The table rotates as programmed.

## ⑨ Stop Button

The table slows down and stops. (Feed Hold Function). When ⑧ is depressed again, the table rotates the remaining angle of the program.

## ⑩ Continuous Feed Button

When this button is depressed, the table rotates continually. And, when ⑨ is depressed, the table stops. The desired feed and direction are to be input in N997 Block. (Refer P.53 ⑧)

## ⑪ Original Point Set Button

When this button is depressed at any angle, the position display shows 000.000°, and it is used as the work zero position. When the cumulative angle becomes 360°, work zero position signal is sent, which can be used as interlock.

## ⑫ Machine Zero Return Button

When this button is depressed, the table returns to the machine zero position (0° of the graduation of the table) clockwise in rapid feed, then low speed for final positioning.

## ⑬ Work Zero Return Button

When this button is depressed, the table returns to the position set by ⑪ clockwise in rapid feed.

## ⑭ Diagnosis Button

## ⑮ Increment/Decrement of Block No.

Previous block data and next block data are displayed.

## ⑯ Feed Rate Override Button

POS mode : Increasing feed rate 5 to 200% every 5% → Rapid feed (999).

PRM mode : Displays the following parameters sequentially.

POS mode : Decreasing feed rate 200 to 5% every 5%.

PRM mode : Displays the proceeding parameters sequentially.

## ⑰ Reset Key

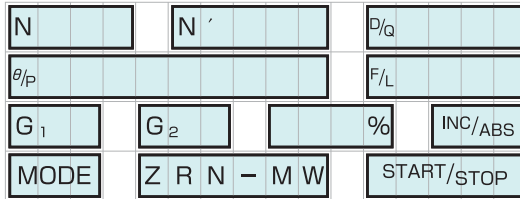
This is for calling N000 and also for resetting alarm display etc.



# Explanation of the PENDANT 2



## 18 Display



- N** : Sequence No. N000~N999
- N RS**: Direct angle command interface is selected.
- N'**: Jump & Return J000~J999, RET
- θ** : Rotation angle of table (Decimal, Sexagesimal)  
0~±999.999° (Decimal)  
0~±999.59'59" (Sexagesimal)
- D** : Equal division (divided by 2 to 9999)
- F** : Feed rate  
Cutting feed: 0.01~9.99min<sup>-1</sup>  
Rapid feed: 000
- G** : Preparatory function G01~G92  
Two kind of G codes (G1, G2)  
can be input in one block.
- %**: Feed rate override  
(5% to 200%, or 999 for rapid feed rate)
- P** : Starting block No. of repeating function (G27)
- Q** : Final block No. of repeating function (G27)
- L** : Repeating frequency (G27)
- INC/ABS**: **INC** (Incremental)  
**ABS** (Absolute)
- MODE**: **EDT** (Edit mode)  
**MAN** (Manual mode)  
**AUT** (Auto. mode)  
**MPG** (MPG mode)  
**DGN** (Diagnostic mode)
- ZRN-MW**:  
**M Flickering** (Returning to M ZERO)  
**M** (Stop at M ZERO)  
**W Flickering** (Returning to W ZERO)  
**W** (Stop at W ZERO)
- START/STOP** : **START** (Starting)  
**STOP** (Stop)

## 19 Key Encoder

For calling a certain sequence, input the number after this key so that the program of the block is display, also you can start from the program.

This key is to be used when you want to call sub program N' or jump to N' after N block is completed.

When sub program is finished, enter R at 18 N' display. And, it returns to the block next to the one where J' was commanded in the main program.

**θ** : You can input 0° to ±999.999° in 0.001° increment, or 0° to ±999° 59'59" in 1" increment.  
The selection of decimal or sexagesimal system is set up by parameter.  
In case of Dwell Instruction (G04), the waiting time is inputted. (0.001 to ±999.999 sec.).

**P** : Starting number of repeating function (G27)  
000 to 999.

**DIV**: Automatic equal dividing times 0 to 9999.  
Lead cutting instruction (G07) 0 to 999.

**Q** : Final number of repeating function (G27)  
000 to 999.



F, L (3digits)



G NO

- F** : Cutting feed F001(0.01 min<sup>-1</sup>) to F999(9.99 min<sup>-1</sup>).  
Rapid feed F000 or F0.
- L** : Repeating frequency 0 to 999.

- Without G : Positioning
- G04 : Dwell
- G06 : Constant acceleration
- G07 : Rotation number
- \* G08 : Buffer commencing
- \* G09 : Buffer ending
- \* G10 : Brake unclamped
- \* G11 : Brake clamped
- G14 : Uni-directional positioning
- \* G15 : Droop check
- \* G16 : Droop cancel
- G21 : Simultaneous start
- G22 : Continuous start
- G23 : Machine zero point return
- G24 : Work zero point return
- G27 : Repeating function
- G28 : Programmable machine zero position return
- \* G90 : Absolute command
- \* G91 : Incremental command
- G92 : Coordinate system setting

### M Function (Option)

#### G60~G74 : Activate an actuator

### How to enter G code :

0 cannot be suppressed for both G1 and G2 codes.  
For example, when G1=07 and G2=08, enter them as follows;

**G 0 7 0 8 \***

and indication will become as ;

G1	G2
07	08

When you want to enter 9°, just depress keys as **θ** → **9** → **.**, and 9.000° or 9°00'00" is displayed.



This is for command of Counter clockwise rotation.

This is depressed as programming of each block being completed.  
(Hereafter shown as **\***).

For deletion or alternation of θ, DIV, or F individually, just depress θ, DIV, or F, then depress. Also when you depress **\*** with pressing **C**, complete one block is deleted.

### Deleting successive blocks

For example, in order to delete blocks from N000 to N999, push keys **N** **0** **▢** **999** at Edit mode, and jog **\*** while depressing **C** key.

**\*** means optional function.

Operation of the pendant of **NEW** α21 controller for tilting axis specification and for NSV index specification differs, please refer instruction manual.



(3digits)



(3digits)



(3digits)



θ (±6~7digits)  
P (3digits)



DIV (4 digits)  
Q (3digits)



## Caution for **NEW** α21 Controller

- The alarm regarding the absolute encoder will be appeared, when turning the POWER ON at first time just after connecting the cable. This is because the coordinate system is not established yet. Please try as follows;
  - **DGN** Return to pervious mode.
  - **PRM** **DGN** **1** **DATA** **1** **\*** PRM#110=1  
Writing parameter value enable.
  - **G NO** **7** **2** **DATA** **1** **\*** PRM#72=1
  - Turn the POWER OFF and ON
  - For rotary axis **M ZRN** Execute machine zero return.  
For tilting axis First set the temporary machine zero position and **M ZRN**.  
Please refer instruction manual for more detail.
- When the alarms regarding the absolute encoder such as ALARM#1101 or #1102 are appeared, please set PRM#71=1 and turn the POWER OFF and ON to establish the coordinate system again.

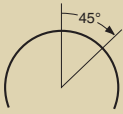


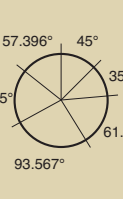
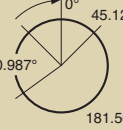
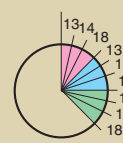


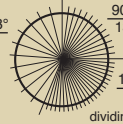
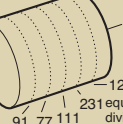
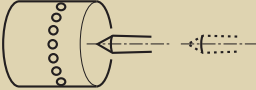
# Operation & Confirmation of PROGRAMS



Before programming, be sure that mode is [EDT].

Before start the programs, push [F1]..... or [F2]..... in [EDT] mode, and confirm input data. Then start the program in [MAN] mode to confirm the moving.

## Operation of Keys.

<p>① Angle Dividing</p> 	<pre>N 0 0 0 G 0 4 5 . F 0 *</pre> <p>Input Angle</p> <p>Rapid feed.</p> <p>No need of pressing 0 under decimal point.</p> <p>Sequence No.</p>
<p>② Arc Milling</p> 	<pre>N 0 0 0 G 4 5 1 2 3 F 1 2 3 *</pre> <p>123 x 1/100 min<sup>-1</sup> rotation speed. means 45.123° Cutting Feed : = 2 πR x 1.23 min<sup>-1</sup> = 7.7 R mm/min.</p>
<p>③ Equal Dividing</p> 	<pre>N 0 0 0 J 0 G 4 5 . F 0 *</pre> <p>After finishing N000 return to N000.</p>
<p>④ Unequal Dividing</p> 	<pre>N 0 0 0 G 4 5 . F 0 * 0 0 1 G 3 5 1 2 0 0 0 2 G 6 1 5 6 7 0 0 3 G 9 3 5 6 7 0 0 4 G 6 7 3 5 0 0 0 5 J 0 G 5 7 3 9 6</pre> <p>In case of the same feed rate in the following blocks just command once. (Modal type)</p> <p>After finishing N005 return to N000.</p>
<p>⑤ Incremental/ Absolute Dividing</p> 	<pre>N 0 0 0 G 4 5 1 2 3 F 0 G 9 1 * 0 0 1 G 1 8 1 5 6 7 0 0 2 G 9 0 9 8 7 0 0 3 J 0 G 0 . N 0 0 0 G 9 0 *</pre> <p>Incremental Command (Modal Type)</p> <p>To W zero-point</p> <p>Absolute Command (Modal Type)</p>
<p>⑥ Repeating Function</p> 	<pre>N 0 0 0 G 1 3 . F 0 * 0 0 1 G 1 4 . 0 0 2 G 1 8 . 0 0 3 G 2 7 P 0 DIV 2 F 2 *</pre> <p>L : Repeat 2 times</p> <p>θ : Starting N000</p> <p>Q : Finishing N002</p> <p>Command of repeating function</p> <p>• SUB-Program (J/RET) and Loop-Jump Function (G25) can be used. However, programming can be done more easily when Repeating Function (G27) is used.</p>
<p>⑦ Counter Clockwise Rotation</p> 	<pre>N 0 0 0 G 4 5 . F 0 *</pre> <p>Counter Clockwise (CCW)</p>
<p>⑧ Continuous Feed 0.5</p> 	<pre>N 9 9 7 G 0 . F 5 0 *</pre> <p>Continuous feed 0.5min<sup>-1</sup> (CCW)</p> <p>Command of continuous FeedStart</p> <p>Start</p> <p>Stop</p>
<p>⑨ Equal Dividing of Arc</p> 	<pre>N 0 0 0 G 9 0 . DIV 1 3 F 2 0 0 * 0 0 1 G 1 1 2 . DIV 2 3 F 0 * 0 0 2 J 0 G 1 5 8 . DIV 1 1 *</pre> <p>This means 90°÷13. Feed rate can be commanded from 0.01 min<sup>-1</sup> to rapid speed.</p>
<p>⑩ Equal Dividing of Circle (360°)</p> 	<pre>N 0 0 0 G 3 6 0 . DIV 9 1 F 0 * 0 0 1 G 3 6 0 . DIV 7 7 * 0 0 2 G 3 6 0 . DIV 1 1 1 * 0 0 3 G 3 6 0 . DIV 2 3 1 * 0 0 4 J 0 G 3 6 0 . DIV 1 2 3 1 *</pre> <p>91 Equal dividing of circle and go to N001</p> <p>77 Equal dividing of circle and go to N002</p> <p>111 Equal dividing of circle and go to N003</p> <p>231 Equal dividing of circle and go to N004</p> <p>1231 Equal dividing of circle and return to N000</p>
<p>⑪ M function</p> 	<p>Optional Specification</p> <pre>N 0 0 0 G 6 0 0 0 1 G 3 6 0 . DIV 1 0 0 0 2 G 6 1</pre> <p>* Tailstock forward</p> <p>* Circle is equally divided into 10 sections.</p> <p>* Tailstock backward</p> <p>Example of automatic operation using M function. G62 on the rotary axis controller is M function to active the tilting axis controller for 5AX- table.</p>

## ① Example for Circle Drilling & Tapping (23 equal division)

### ● Program of NC Machine

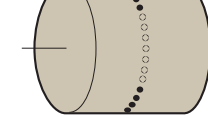
```

0 0 0 0 ; Main program
M 9 8 P 0 1 0 0 L 2 3 ; Drilling cycle 23 times
M 9 8 P 0 1 0 1 L 2 3 ; Tapping cycle 23 times
M 0 2 ;
0 0 1 0 0 ; Sub program 1
G 0 1 Z — ; Drilling fixed cycle
M 2 1 ;
M 9 9 ;
0 0 1 0 1 ; Sub Program 2
G 0 1 Z — ; Tapping fixed cycle
M 2 1 ;
M 9 9 ;
    
```

### ● Program of X21

```
N 0 0 0 J 0 G 3 6 0 D W 2 3 F 0 *
```

23 equal dividing of 360°  
After finishing N000, return to N000 again.



23 equal dividing on circle for drilling & tapping

When NC Machine executes the sub program 23 times, drilling & tapping of 23 holes is completed with 23 equal divisions calculated to 1/23rd of 360° to third decimal places automatically, e.g. 15.652°.

## ② Example for Arc Milling

### ● Program of NC Machine

```

0 0 0 0 1 ;
M 2 1 ;
G 0 1 Z — ; Z axis down
M 2 1 ;
G 0 0 Z — ; Z axis up
M 2 1 ;
    
```

### ● Program of X21

```
N 0 1 0 G 2 1 0 F 0 G 9 1 * Rapid feed to starting point ①
```

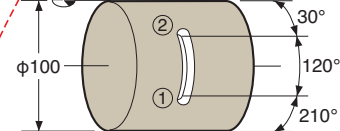
Incremental command (Modal Type)

```
0 1 1 G 1 2 0 F 5 0 * Arc milling to ②
```

Milling by rotating speed of 0.5min<sup>-1</sup>

```
0 1 2 J 1 0 G 3 0 F 0 * 30° of rapid feed to work zero position
```

After finishing N012, return to N010



(Calculation of cutting speed)  
 $100 \times \pi \times 50 \times 1/100 \text{ min}^{-1} = 157 \text{ mm/min}$

## ③ Example for Lead Cutting

### ● Program of NC Machine

```

0 0 0 0 3 ;
M 2 1 ;
G 0 1 Z — ; Z axis down
M 2 1 ;
M 2 1 ;
G 0 1 X 4 0 . F 1 0 0 ; *1
G 0 0 Z — ; Z axis up
M 2 1 ;
    
```

### ● Program of X21

```
N 0 2 0 G 2 4 0 F 0 G 9 1 * Rapid feed to starting point ①
```

```
0 2 1 G 1 0 * Brake unclamped
```

```
0 2 2 G 7 9 3 3 8 F 5 5 G 2 1 * Cutting feed to ②
```

\*2 Simultaneous start

```
0 2 3 J 2 0 G 0 G 9 0 1 1 * Rapid feed to work zero position
```

G90 (Absolute) & G11 (Brake clamped)

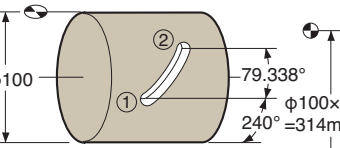


Fig. 1

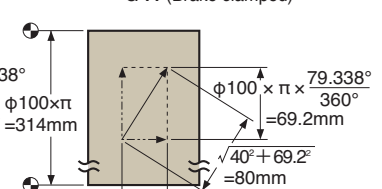


Fig. 2

### — Calculations for Feed Rate in Lead Cutting —

1. Make a development elevation like Fig.2 to calculate the vector.
2. Give feed in lead cutting (cutting feed from ① to ②).....e.g. 200 mm/min (depend on work piece materials).
3. Cutting speed of X axis:  $F_x = 200 \text{ mm/min} \times 40 \text{ mm} \div 80 \text{ mm} = 100 \text{ mm/min}$  F100 \*1
4. Cutting speed of θ axis:  $f = 200 \text{ mm/min} \times 69.2 \text{ mm} \div 80 \text{ mm} = 173 \text{ mm/min}$   
 $173 \text{ mm/min} \times 1 \text{ min}^{-1} \div 314 \text{ mm/min} = 0.55 \text{ min}^{-1}$  F55 \*2

## ④ Example of continuous rotation as turning operation

### ● Program of NC Machine

```

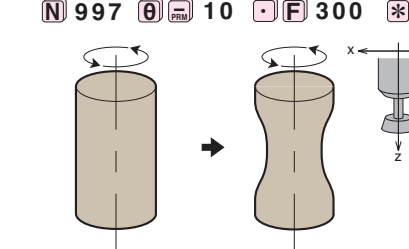
0 0 0 0 4 ;
M 2 1 ; Start continuous rotation
X & Z Contouring
M 2 1 ; Stop continuous rotation
M 2 1 ; Machine zero position return with dog
    
```

### ● Program of X21

```
N 0 3 0 G 2 2 * Continuous rotation
```

```
N 0 3 1 J 3 0 G 2 8 * Programmable machine zero position return with dog
```

```
N 9 9 7 G 1 0 F 3 0 0 * Higher rotation speed
```

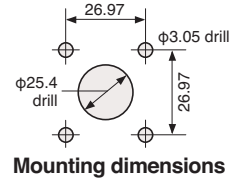


The direction and feed rate of continuous rotation are specified on N997. When higher rotation speed than standard is required, please contact with us.

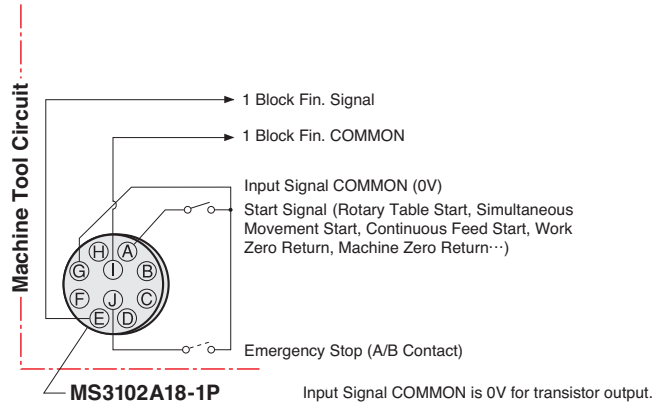
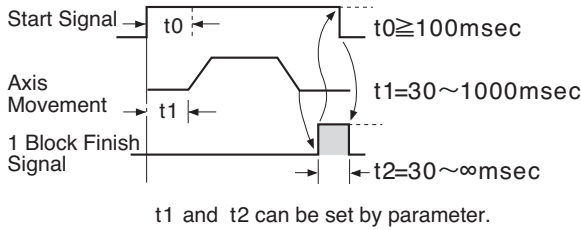
## The Connection of $\alpha 21$

Normally the controller will be operated only by connecting M Signal (Start Signal) and 1 Block Fin. Signal. Emergency Stop Input must be set to B contact only for 5AX-Tables. For other Tables, you can choose A/B contact for Emergency Stop Input.

When to be connected to machine, receptacle MS3102A18-1P is provided. Arrange the electric circuits of your machine side.



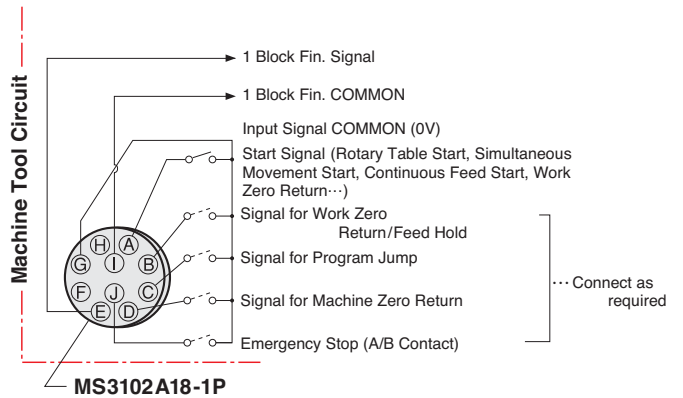
## Input/Output Time Chart



## Connection for Automatic Operation

Once program is loaded to  $\alpha 21$ , all operations such as Power ON, Machine Zero Return, Program Section, Start etc. can be done by machine side. 3 sets of M signals are required for CNC rotary table and 6 sets of M signal are required for 5AX-tilting rotary table. e.g.

- M21** : Start Signal
- M22** : Program Jump (Selection) Signal
- M23** : Machine Zero Return and Reset



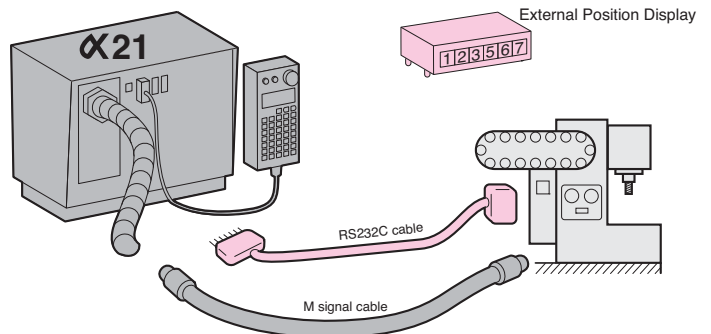
## RS232C Automatic Loading Interface. ... Pendant is to be used for manual operation and maintenance only.

JAPAN PAT.

Program is loaded from Custom Macro of M/C, and start the program by the ordinary M signal. Total management of programs can be done on only M/C side. The necessary functions of M/C side are;

- Custom Macro
- Custom Macro External Output Function
- 2 sets of M signals

- e.g.
- M21** : Start signal
  - M24** : Start signal of RS232C Automatic Loading Function (Start signal without 1 Block Fin. signal confirmation and keep this signal ON at least 100msec.)



```
M/C Main Program
e.g. Machining of Imperial Blade
O0001;
G65 P8000;
...
G01 Z_;
X300;
Y_Z_M21;
X0;
Y_Z_M21;
X300;
...

```

X0. X300.

```
Macro Program
(Down Loading to  $\alpha 21$ )
O8000;
M24; Activate  $\alpha 21$  automatic loading function.
POPEN;
#100=165;
BPRNT[#100[0]];
DPRNT[N10 G90 A22.149];
...
#100=165;
BPRNT[#100[0]];
G04 P3000; Dwell 3sec.
PCLOS;
M66;

```

**N No. must be specified on each block data.**

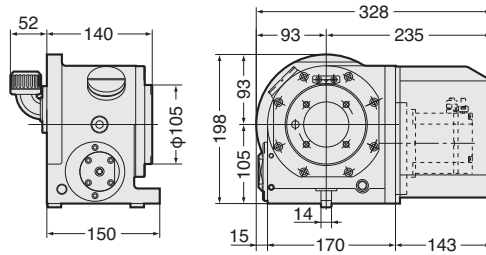


# CNC ROTARY TABLE with $\alpha$ 21 CONTROLLER

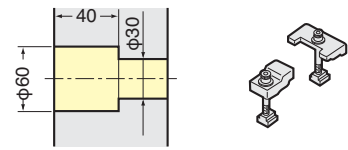


Dimensions with NIKKEN  $\alpha$ 21 controller are shown.  
Please contact with us for CAD data (2D:DXF, 3D:PARASOLID).

## CNC105AA21-04



**Powerful Brake**  
Brake Torque : 205Nm

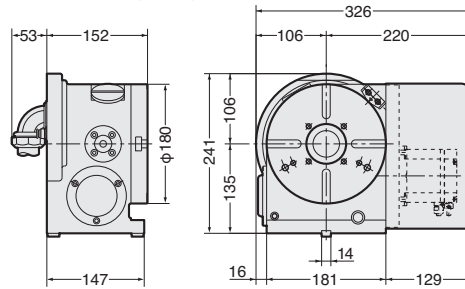


Air purge function is provided.

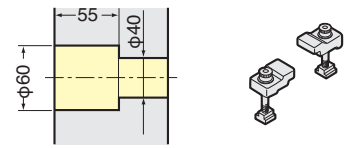
## CNC180AA21-04



CNC180AA21-04 (400W) is standard. CNC180AA21-08 (750W) and CNC180AA21-06 (High Torque) are available.



**Powerful Brake**  
Brake Torque : 303Nm

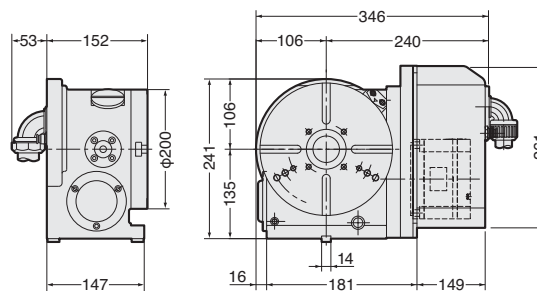


Air purge function is provided.

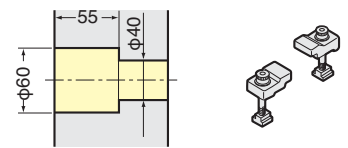
## CNC202AA21-08



CNC202AA21-08 (750W) is standard. CNC202AA21-06 (High Torque) is available.

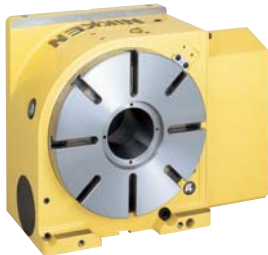


**Powerful Brake**  
Brake Torque : 303Nm

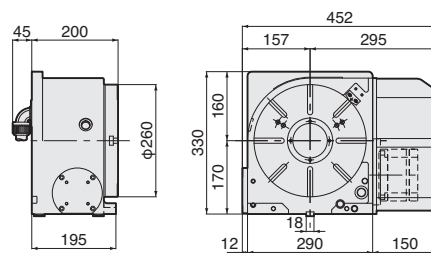


Air purge function is provided.

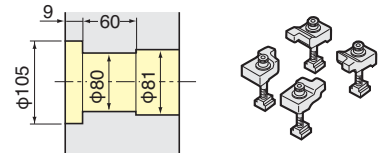
## CNC260AA21-08



CNC260AA21-08 (750W) is standard. CNC260AA21-06 (High Torque) is available.



**Pneumatic Brake Torque UP**  
588Nm

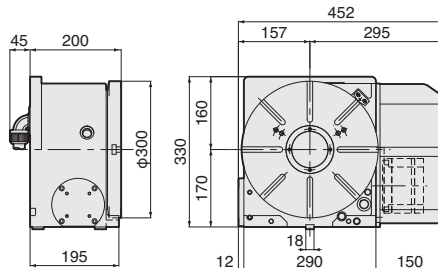


For the rotary table with pneumatic brake, air purge function is provided inside the motor cover as standard.

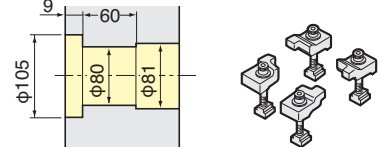
## CNC302AA21-08



CNC302AA21-08 (750W) is standard. CNC302AA21-06 (High Torque) is available.



**Pneumatic Brake Torque UP**  
588Nm



For the rotary table with pneumatic brake, air purge function is provided inside the motor cover as standard.

High speed rotation Z series is available for all models of CNC rotary table. e.g. CNCZ260AA21

# CNC ROTARY TABLE with $\alpha$ 21 CONTROLLER

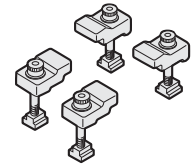
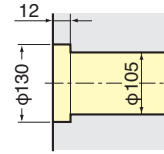
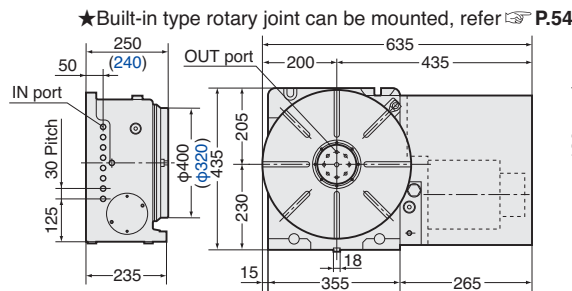
**NIKKEN**

Dimensions with NIKKEN  $\alpha$ 21 controller are shown.  
Please contact with us for CAD date (2D:DXF, 3D:PARASOLID).

## CNC321, 401A21-18

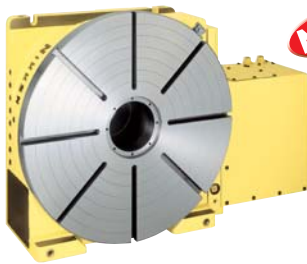


Photo shows with rotary joint (Option).

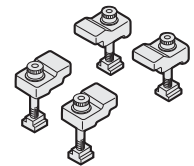
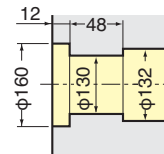
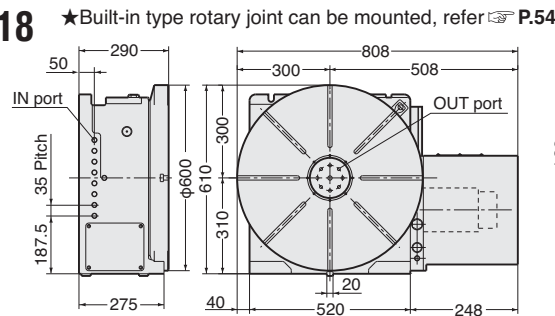


★ Please contact us for the dimension of **CNC321A21-18**.

## CNC501, 601, 802A21-18



**NEW**



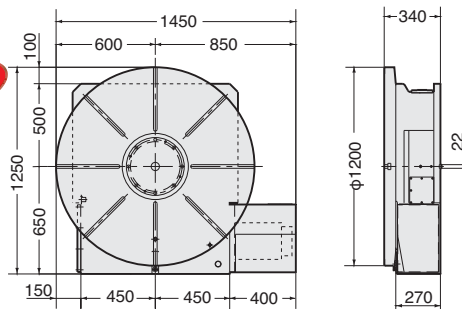
★ Please contact us for the dimension of **CNC501, 802A21-18**.

## CNC1000, 1200A21



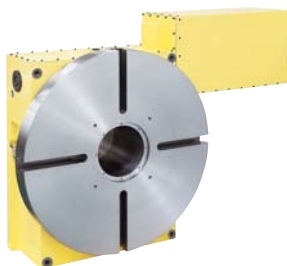
**NEW**

Photo shows with center socket (Option).

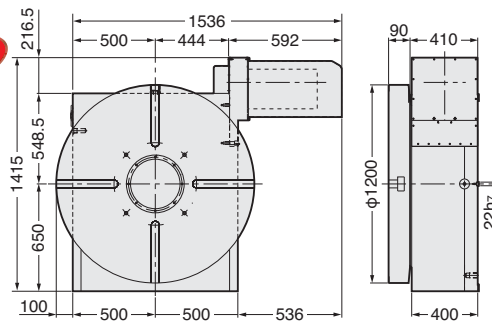


★ Ultra precision of  $\pm 3$ sec. is available as an option.  
There is no through hole on the rotary table due to the rotary encoder for ultra precision option.  
★ Please contact us for the dimension of **CNC1000A21**.  
★ Code No. will be varied according to the servo motor capacity, e.g **CNC1000A21-27** (2.7KW Motor)

## CNC1201A21

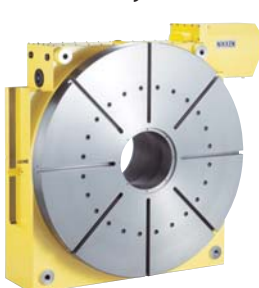


**NEW**

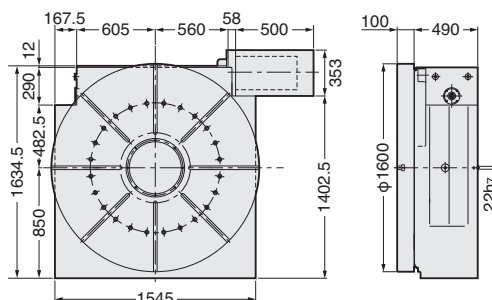


★ Ultra precision of  $\pm 3$ sec. is available as an option.  
There is no through hole on the rotary table due to the rotary encoder for ultra precision option.  
★ Please contact us for the dimension of **CNC1000A21**.  
★ Code No. will be varied according to the servo motor capacity, e.g **CNC1201A21-110** (11KW Motor)

## CNC1600, 2000A21



**NEW**



★ Ultra precision of  $\pm 3$ sec. is available as an option.  
There is no through hole on the rotary table due to the rotary encoder for ultra precision option.  
★ Please contact us for the dimension of **CNC2000A21**.  
★ Code No. will be varied according to the servo motor capacity, e.g **CNC1600A21-44** (4.4KW Motor)

The specification of the large rotary table will be varied according to your application.

1. With/without T slot, Width of T slot
2. Spindle hole dimension...Centre socket for centring is normally attached.
3. Layout of the rotary table...Vertical use, horizontal use, vertical and horizontal use
4. Total reduction ratio...Suitable capacity of the servo motor will be selected.

# Tilting Rotary Table with $\alpha 21$ Controller



Dimensions with NIKKEN  $\alpha 21$  controller are shown.  
Please contact with us for CAD date (2D:DXF, 3D:PARASOLID).

## 5AX-130WAA21

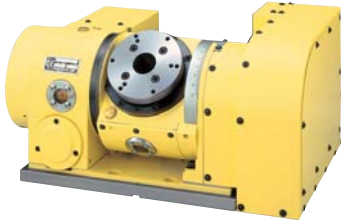
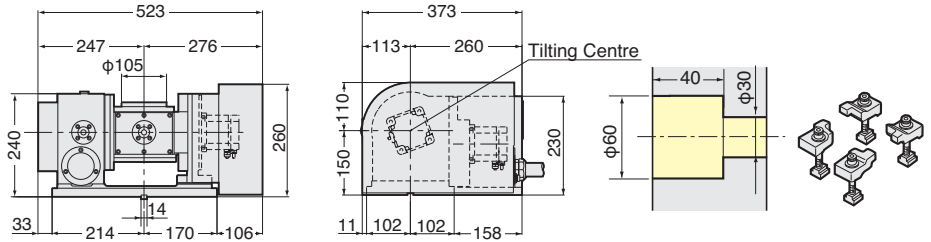
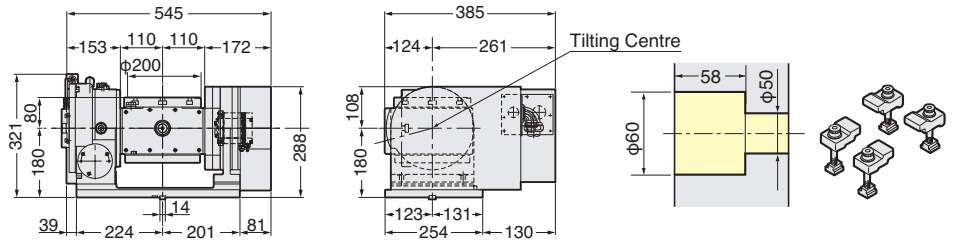


Photo shows with  $\phi 130$ mm plate.  
Rotary axis cable stays.



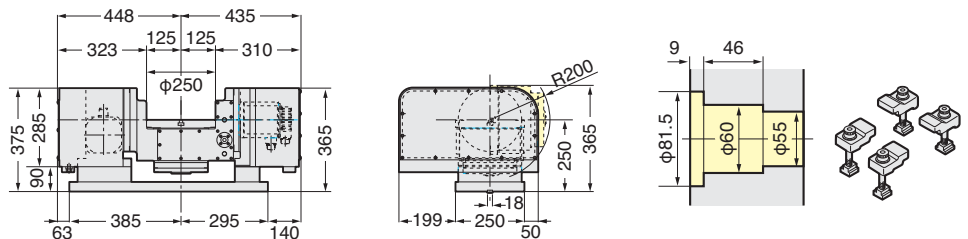
Motor capacity of rotary axis and tilting axis is added at the end of Code No. e.g 5AX-130WAA21-0404

## 5AX-201WAA21



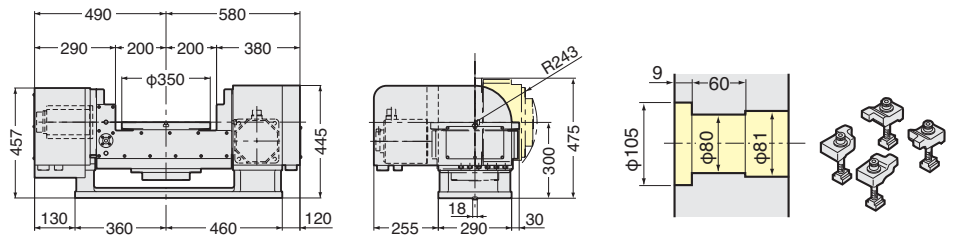
Motor capacity of rotary axis and tilting axis is added at the end of Code No. e.g 5AX-201WAA21-0408

## 5AX-250WA21



Motor capacity of rotary axis and tilting axis is added at the end of Code No. e.g 5AX-250WA21-1313

## 5AX-350WA21

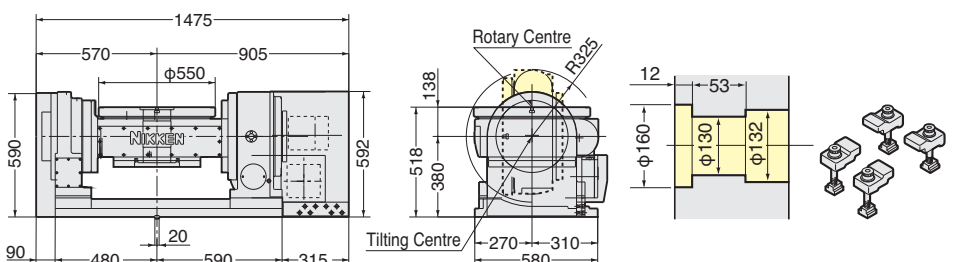


Motor capacity of rotary axis and tilting axis is added at the end of Code No. e.g 5AX-350WA21-1318

## 5AX-550WA21



Photo shows with centre socket (option).  
Rotary axis cable stays.



Motor capacity of rotary axis and tilting axis is added at the end of Code No. e.g 5AX-550WA21-1818



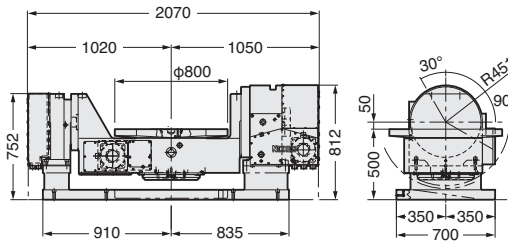
# Tilting Rotary Table with $\alpha 21$ Controller



Dimensions with NIKKEN  $\alpha 21$  controller are shown.  
Please contact with us for CAD date (2D:DXF, 3D:PARASOLID).

## 5AX-800WA21 **NEW**

The specification of the large rotary table will be varied according to your application.



Motor capacity of rotary axis and tilting axis is added at the end of Code No. e.g 5AX-800WA21-1875

1. Moving angle of the tilting axis
2. Relation between the tilting axis centre and the rotary axis



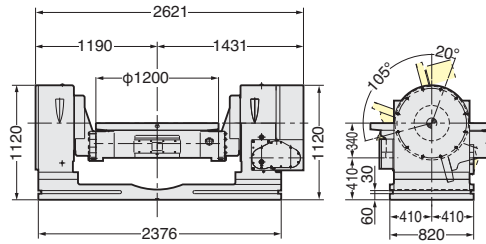
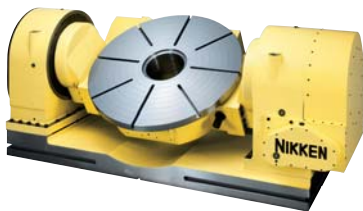
**5AX-1200A:**The tilting axis center is located in the same position as the center of the rotary axis body.



**5AX-1200B:**The tilting axis center is located in the same position as the top surface of the rotary axis.

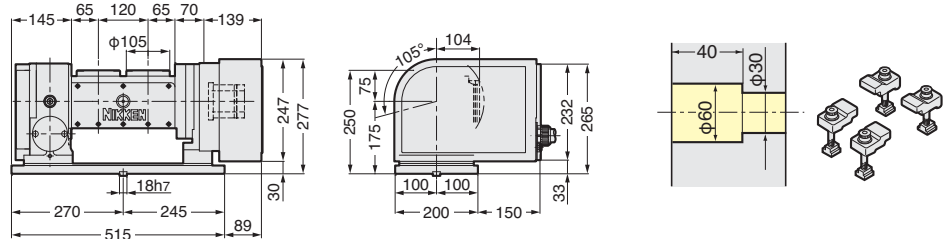
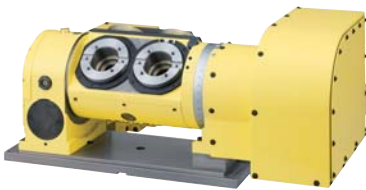
3. Tilting axis base...It can be supplied to us.
4. With/ without T slot, Width of T slot
5. Spindle hole dimension  
...Centre socket for centring is normally attached.

## 5AX-1200WA21 **NEW**









Motor capacity of rotary axis and tilting axis is added at the end of Code No. e.g 5AX-1200WA21-4444

## 5AX-2MT-105WAA21



Motor capacity of rotary axis and tilting axis is added at the end of Code No. e.g 5AX-2MT-105WA21-0404

$\alpha 21$  controller can drive the all models of NIKKEN rotary tables.  
Please contact us for the external dimension.

 <p>Back side motor mounted CNC rotary table</p>	 <p>Top side motor mounted CNC rotary table</p>	 <p>Multi-spindle CNC rotary table</p>	 <p>NST manual tilting rotary table</p>
 <p>NSVZ index</p>	<p>Indexing of MIN. incremental of 1° is done by <math>\alpha 21</math> controller.</p>	 <p>NSVX rotary indexing table</p>	<p><math>\alpha 21</math> controller can perform indexing of MIN. 1° with hirth coupling and can also perform indexing of MIN. incremental by 0.001° and profile milling.</p>

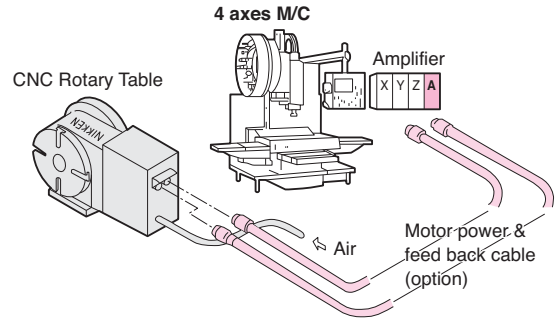
# Selection of the CNC ROTARY TABLE



## CNC Rotary Table with Additional Axis Interface

In case of that the M/C has an additional axis interface for CNC rotary table, please select this series. In this case we could supply the rotary table to suit any of your M/C interface and the servo motors. Please refer **P.37** for the details of the motors.

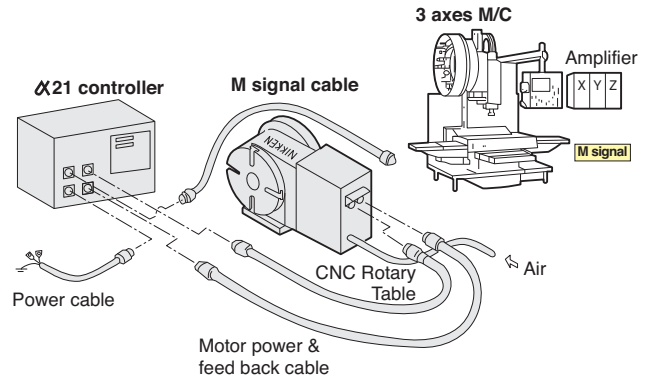
1. 4th axis amplifier which has to match up with X, Y & Z axes to suit the M/C controller.
2. The same series of the motors as the other axis has to be fitted on the rotary table to be driven.  
(The size of the motor and amplifier is dependent on the CNC rotary table model.)
3. The motor can be provided by the customer or by **NIKKEN**.
4. The overall dimensions and the specifications will be changed according to the servo motor.
5. It might be necessary to be prepared to install the 4th axis interface; cable connections, hydraulic supply, and set up the parameter by the M/C builder.



## CNC Rotary Table with NIKKEN Controller (M-signal series)

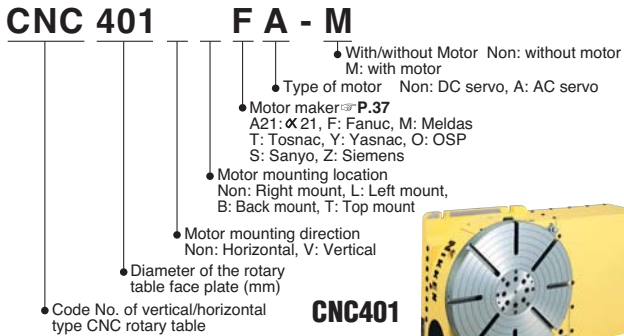
The CNC rotary table with **NIKKEN $\alpha$ 21** controller that can be driven by 1 off M-signal (or contact signal) from your M/C, NC Milling machine or conventional milling machine for high precision indexing, equality dividing (2~9999 dividing), or spiral cutting etc. The retrofitting can be done on your existing machine. **P.61**

1. Required 1 off M-signal at the machine side.
2. The rotary table can be installed on any machine, e.g. NC milling machine or conventional machine.
3. **NIKKEN** provide the rotary table complete with the controller, servomotor and set of cables.

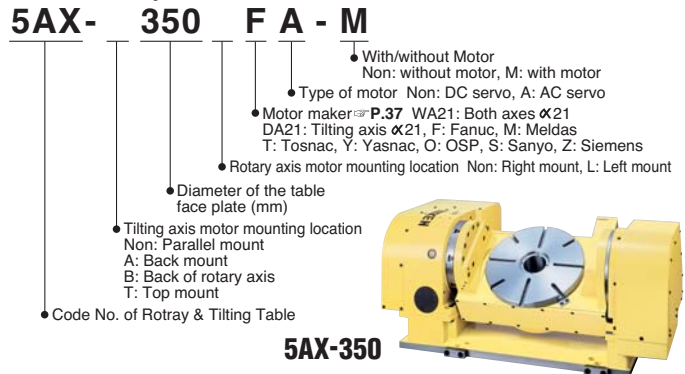


## Explanation of Code No.

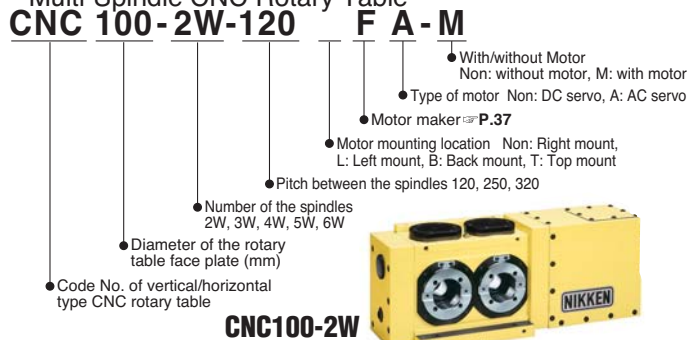
### Single Axis CNC Rotary Table



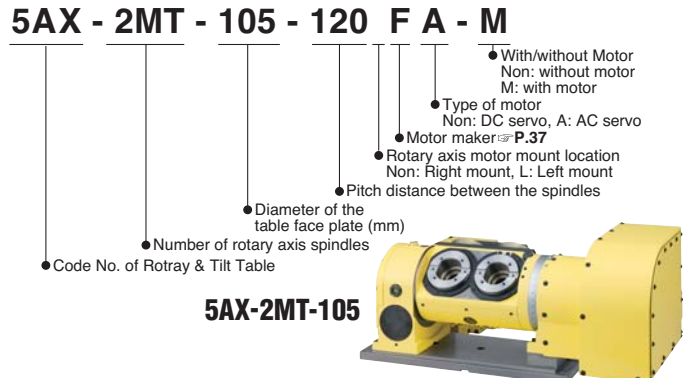
### 5AX Rotary & Tilt Table



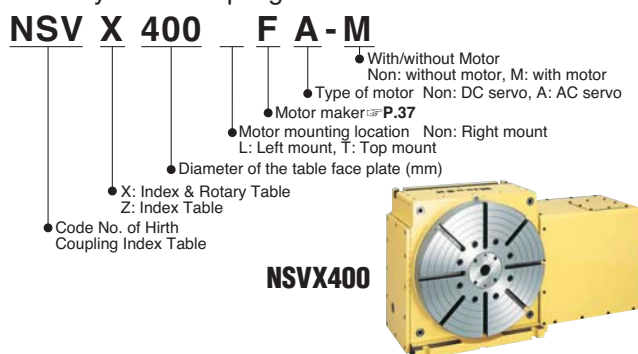
### Multi-Spindle CNC Rotary Table



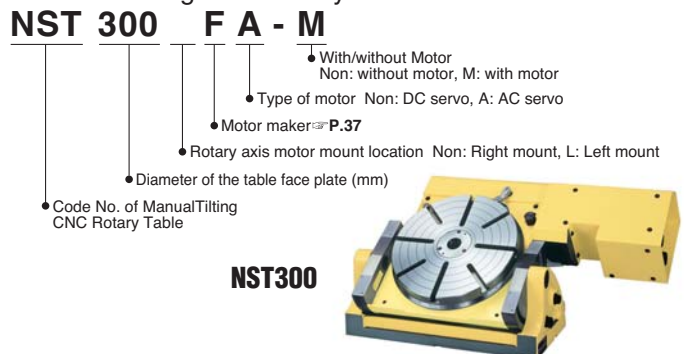
### 5AX Multi Spindle Rotary & Tilting Table

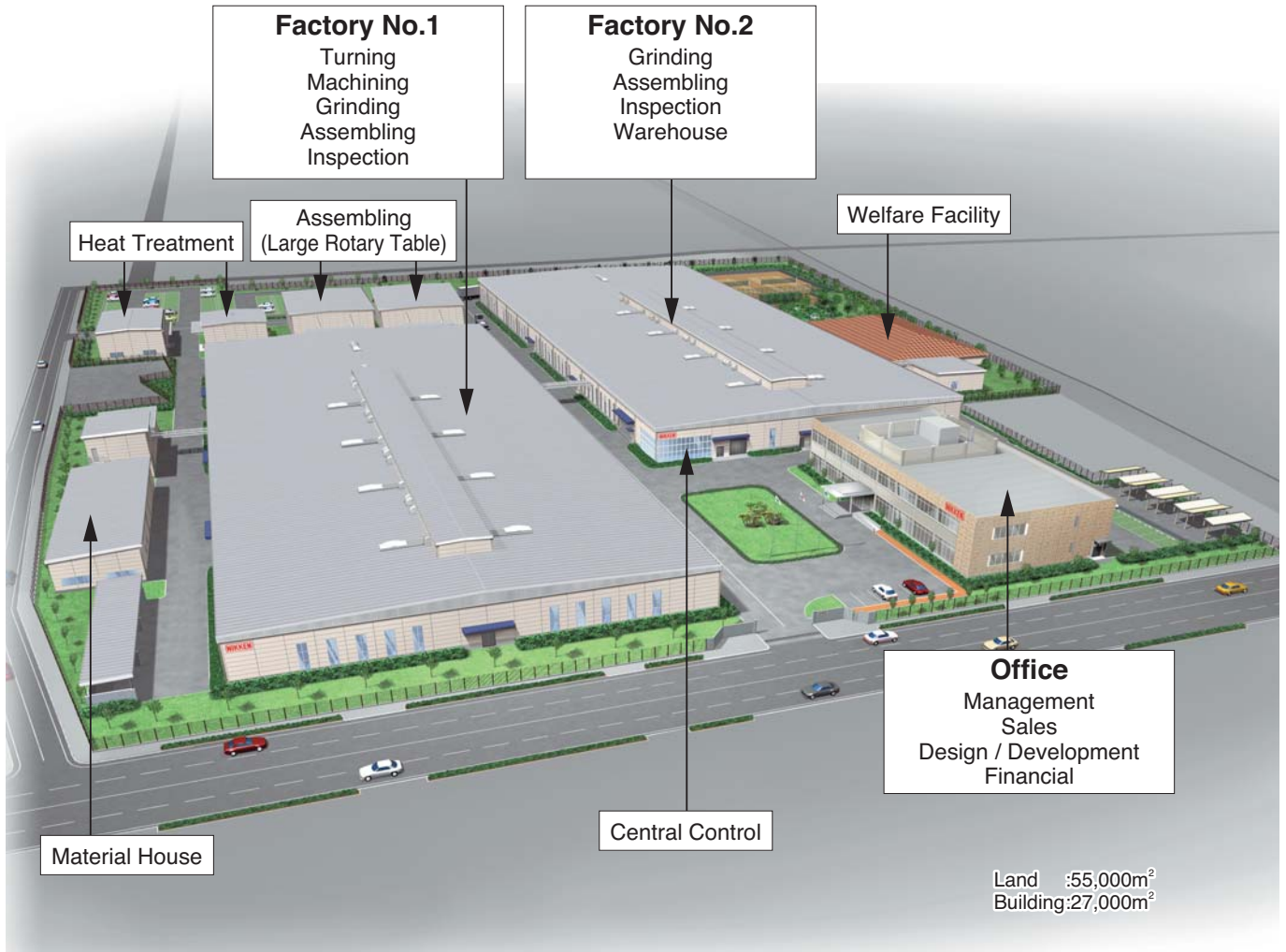


### Rotary Hirth Coupling Index Table



### Manual Tilting CNC Rotary Table





## Carbonizing & Sub-Zero Treatment

NIKKEN is the only tooling product manufacturer which performs sub-zero treatment for tooling. This refers to a technique where -90 deg. ultra-low-temperature processing is performed after carbonizing and quenching in order to eliminate the residual austenite and to form 100% martensite compositions to prevent deterioration over time. This technique has been applied for block gauges and for bearings of the highest grade in the past. It is an example of how NIKKEN pays attention to those aspects which are often hidden from view and how we put our hearts and souls into each and every tooling product.

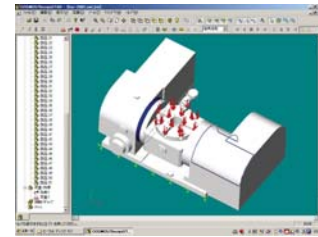


## Ion Nitriding

Ion nitriding refers to a nitriding process where glow discharges are generated in a vacuum of a nitrogen-mixed gas atmosphere to heat the workpieces at a low temperature of 450 deg. while at the same time nitriding them by a sputtering action. This processing improves both the wear resistance and sliding performance. (It reduces the surface friction coefficient.) The experience and know-how of ion nitriding have been utilized in a large number of NIKKEN's products, including worm wheels for CNC Rotary Tables and Tough-Cut Skill Reamers.

## Design & Development

We fully utilize the high advanced technology, e.g. 3D CAD and FEM analysis to improve the quality and the speed of design and development.



## NC Lathe Lines

Unmanned NC lathe lines are in full operation with utilizing of the Oil Jetter System and **Combat Z Drills**.



## Small T/C and M/C line

Utilizing small CNC rotary tables, NC5-46 toolings and Major Dream holders, this is highly sophisticated for high productivity line.



Multi-Surface Jig Holder for holding small parts

## Horizontal Machining Centre Lines

Utilizing NIKKEN's double contact tooling system, such as **NC5** and **3LOCK** tooling improves the cutting performance and productivity.



## Finish Machining Room

The fine finish machining operation is carried out in a designated room where the room temperature is kept at  $20.5^{\circ}\text{C} \pm 0.5^{\circ}\text{C}$  at all times. The machines in the room are specially designed for the ultra high precision (European Fine Jig Borer also).



**Hobbing of the Worm Wheel**



**Screw Grinding Lines for Carbide Worm Screw etc.**



**Grinding of the Hirth Coupling**



☺ Mark is required on products exported to European market since 1995 under the safety regulation.

☺ Mark Declaration of Conformity



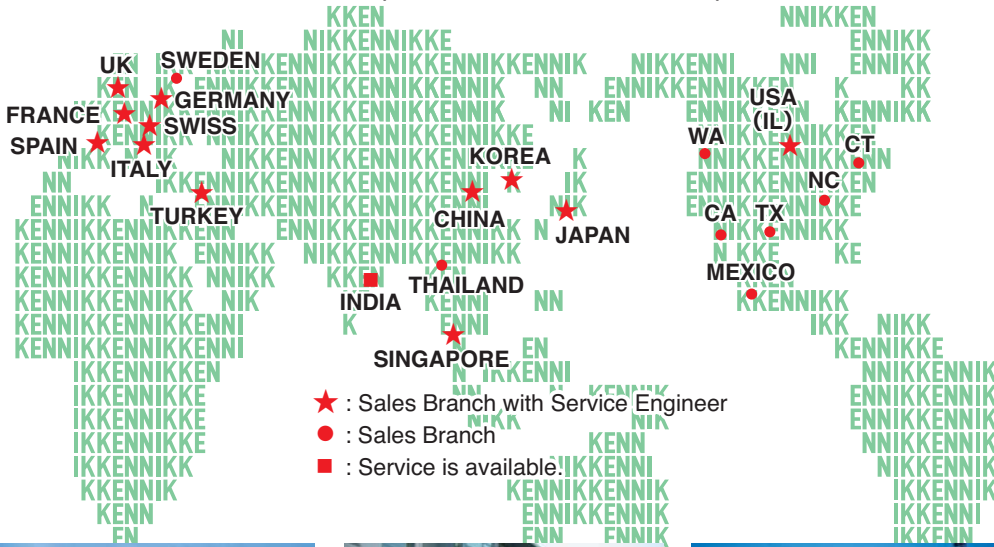
### CNC Table Assembly Lines

The World No.1 durable, high precision and rigidity CNC Rotary Tables are provided from these lines to the worldwide markets.

# NIKKEN WORLD WIDE SALES BRANCH



There are overseas Sales Branches in 12 countries. Each sales branch has stocks for toolings and CNC Rotary Tables, and service engineers look after the maintenance and service operation of our products. In the other region, e.g. East-South Asia, Ozaena, South America, Africa, etc., there are some distributors. At the production line in abroad, as there are many requirements for special tools and CNC Rotary Table to suit the special specifications, please ask us or distributors for spare tools and maintenance parts in advance.



LYNDEX-NIKKEN (U.S.A.)



HERRAMIENTAS LYNDEX-NIKKEN (MEXICO)



NIKKEN EUROPE & NIKKEN U.K (UK)



NIKKEN DEUTSCHLAND (F.R.GERMANY)



PROCOMO-NIKKEN (FRANCE)



KOREA NIKKEN (KOREA)



NIKKEN SCANDINAVIA (SWEDEN)



VEGA INTERNATIONAL (ITALY)



CUTTING TOOL (SPAIN)



NIKKEN CHINA (CHINA)



NIKKEN SWITZERLAND (SWISS)



NIKKEN TURKEY (TURKEY)



SIAM NIKKEN (THAILAND)



NIKKEN ASIA (SINGAPOLE)

★ **U.S.A**  
CA, CT, IL, NC, TX, WA

**LYNDEX-NIKKEN**  
1468 Armour Boulevard,  
Mundelein, ILLINOIS 60060  
Tel.+1-847-367-4800 Fax.+1-847-367-4815

**MEXICO**  
(From 2014.09)

**HERRAMIENTAS LYNDEX-NIKKEN S.A.de C.V.**  
Av. Hercules #401-13, Fracc. Poligono 3  
Santa Rosa Jauregui, Queretaro 76220  
Tel.+52-55-8421-8421

★ **FRANCE**

**PROCOMO-NIKKEN S.A.S**  
6, avenue du 1er Mai-Z.A.E.Les Glaises 91127  
Palaiseau Cedex  
Tel.+33-(0)-1-69.19.17.35 Fax.+33-(0)-1-69.30.64.68

★ **UK**

**NIKKEN KOSAKUSHO EUROPE LTD.**  
Precision House, Barbot Hall Industrial Estate,  
Rotherham, South Yorkshire, S61 4RL  
Tel.+44-(0)-1709-366306 Fax.+44-(0)-1709-376683

★ **F.R.GERMANY**

**NIKKEN DEUTSCHLAND GmbH**  
Eisenstraße 9c, 65428 Rüsselsheim  
Tel.+49-(0)-6142-550600 Fax.+49-(0)-6142-550600

★ **ITALY**

**VEGA INTERNATIONAL TOOLS S.P.A**  
Via Asti N°9 10026-Santena(TORINO)  
Tel.+39-011-9497911 Fax.+39-011-9456380

★ **SWITZERLAND**

**NIKKEN SWITZERLAND AG**  
Sumpfstrasse 32-CH-6300-Zug  
Tel.+41-(0)-41-748-5000 Fax.+41-(0)-41-748-5001

★ **SCANDINAVIA**  
SWEDEN

**NIKKEN SCANDINAVIA AB**  
Bultgatan 13b, 44240 Kungälv  
Tel.+46-(0)-303-440-600 Fax.+46-(0)-303-58177

★ **SPAIN & PORTUGAL**

**CUTTING TOOL S.L (TOOLING)**  
PORTUETXE 16, BARRIO IGARRA  
E-20018 DONOSTIA-SAN SEBASTIAN  
Tel.+34-(0)-902-820090 Fax.+34-(0)-902-820099  
**NIKKEN EUROPE DIVISORES ESPANA (CNC ROTARY TABLE)**  
Tel.+34-(0)-669-603433

★ **TURKEY**

**NIKKEN KESICI TAKIMLAR SAN. VE ULUSLARARASI TIC. A. S**  
E5 Uzeri Kucukyali Yanyol Irmak Sok.  
Kucukyali Sanayi Sitesi A Blok No:5 Maltepe 34852 Istanbul  
Tel.+90-(0)-216-518-1010 Fax.+90-(0)-216-366-1414

★ **KOREA**

**KOREA NIKKEN LTD.**  
90B-11L, Namdong Industrial Complex, 170, Namdong-Daero,  
Namdong-Gu, Incheon, Korea 405-819  
Tel.+82-(0)-32-763-4461 Fax.+82-(0)-32-763-4464

★ **P.R.CHINA**

**SHANGHAI ZHONG YAN TRADING CO., LTD.**  
BUILDING 1/F, #54, No.1089 QINZHOU RD. (N),  
SHANGHAI, CHINA  
Tel.+86-(0)-216210-2506 Fax.+86-(0)-216210-2083

★ **SINGAPORE**

**NIKKEN KOSAKUSHO ASIA PTE, LTD.**  
268, WOODLANDS CENTRE ROAD, #03-05  
WOODLANDS POINT, SINGAPORE 738931  
Tel.+65-6362-7980 Fax.+65-6362-7980

**THAILAND**

**SIAM NIKKEN Co., LTD.**  
127 Moo5 Gauwungsa-Bangturie Road Tambon Tanokkard  
Ampher Muangnakhonpathom Nakhonpathom 73000 Thailand  
Tel.+66(02)178-0503 Fax.+66(02)178-0504

★ **Branch with service engineer**

New Nikken China facility was moved to Qinzhou Road, Shanghai on 2014. JAN due to the business expansion in China. The standard items of NC tooling & CNC rotary table and each important spare parts are stocked for quick delivery.

You can access to Nikken China with Chinese, Japanese or English. Not only Chinese catalogue but also Chinese instruction manual are provided for Chinese domestic market. Our office has the show room to see and touch our products, and our presentation will be done more practically. Technical seminar of Nikken is also opened at user factory side.



Chinese engineer well trained in Japan is engaged in the service of our products. Different types of the NC controller for the CNC rotary table are provided for the trial running after repair. The most important spare parts are stocked. It is possible to stock the special spare parts of the custom-made tooling or CNC rotary table for further discussion. Please consider to make a contract of "Nikken Rotary Table Overseas Warantee Contract" for the CNC rotary table delivered to China.



The sales of nikken products through Internet is not started in China. For after service and the further maintenance, please purchase Nikken products through authorized distributors.



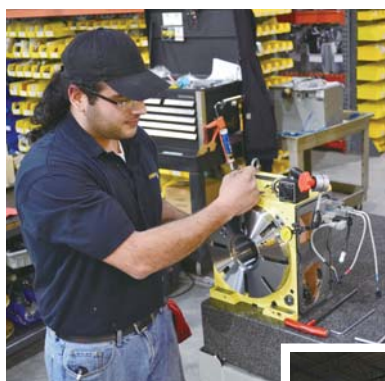
As North America's leading supplier of machine tool accessories, LYNDEX-NIKKEN is a wholly-owned subsidiary of NIKKEN Kosakusho Works., Ltd. - Japan. Backed by over a half century of experience, LYNDEX-NIKKEN sets the standard for high quality and high technology with a complete line of superior toolholders and machine tool accessories. From one source you can expect the best of both worlds: Extreme Quality and Advanced Technology.

LYNDEX-NIKKEN has a team of dedicated application and engineering staff available to advise you on your machining applications and to support our entire product line throughout the U.S., Canada, Mexico and South America. Our regional managers in Chicago, Los Angeles, Boston, Charlotte, Dallas and Seattle support our 1,000 plus distributors with machine tool accessories expertise.

LYNDEX-NIKKEN provides expert process and product consultation for even the most demanding applications with full on-demand field support and ongoing training.

## North American Facility

The LYNDEX-NIKKEN North America headquarters is centrally located near Chicago, Illinois. Our 50,000 sq ft. facility houses an inventory of over 12,000 machine tool accessories stocked for fast delivery. Over 95% of orders are shipped out same day. Our extensive inventory of products includes:



## Products

- **Rotary Tables** - NIKKEN's complete line of CNC Rotary Tables are known worldwide for their wear-resistance, rigidity and high-speed rotation. NIKKEN rotary tables are built to provide high accuracy, increased production and a trouble-free long life.

- **Advanced Toolholders** - Maximize the potential of your machine tools with LYNDEX-NIKKEN's advanced toolholders.

- **Standard Toolholders** - LYNDEX-NIKKEN's complete range of quality-driven toolholding solutions are designed to meet your strictest requirements.



## Service & Support

- Dedicated application and engineering support staff

- Support for entire product line covering the U.S., Canada, Mexico and South America

- On-demand field support and ongoing training

- Customer service and technical support staff

- Expert process and product consultation for even the most demanding applications

- Cutting trials and testing

- Service, repair and custom configuration completed on-site

- Attention to high-tech application demands, including high-speed and balanced toolholding solutions



The NIKKEN Euro Centre based in the UK was opened in 1999; from here we sell, distribute and support all products to our subsidiaries and dealers in over 20 countries around Europe. At the NIKKEN Euro Centre we take great pride in the consistent delivery of the four founding principles of our business: **Absolute Integrity, Uncompromising Quality, Unflinching Support,** and above all **“Total Commitment”** to our customers.



### Product Inventory

NIKKEN Euro Centre facilities has a warehouse space of 13,000m<sup>2</sup>. which holds over 50,000 individual items covering a range of some 4,000 product lines, including the latest generation of Single & Multi Axis CNC Rotary tables, thus making it the largest stock of NIKKEN products in Europe.

### Our Technical Support and Training Section provides our existing customers and potential customers access to:

- A Multimedia based training facility that ensures our customers, through comprehensive training, will realize the full productivity potential of their application.
- A wealth of engineering expertise covering all aspects of application set-up, optimization and implementation that is available for the full life of the NIKKEN product.



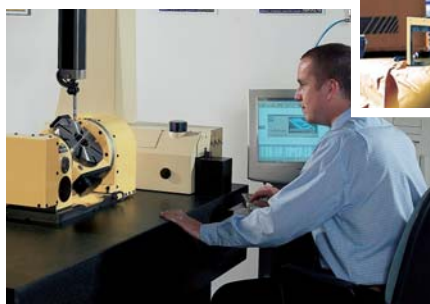
### Our machining centre equipped with Testing Facilities enables us to:

- Research, develop and optimize all of our tooling systems.
- Demonstrate to our potential customers the advantages of using both NIKKEN Tooling and CNC Rotary Tables in their applications.



### Our Service Department specializes in:

- Providing on-site inspections prior to rotary table repairs and refurbishment by our own NIKKEN trained service engineers.
- Providing tooling and rotary tables optimized to seamlessly integrate into any application.



Nikken Deutschland GmbH, a wholly owned subsidiary in Germany of NIKKEN Kosakusho Works, was established in 2003 to take over the sales activities of the previous distributor. Based in Russelsheim, which is a town made famous by the manufacturing complex of Opel, the company is located about 15 minutes away by car from Frankfurt airport. Germany has ranked at the top of the machine tool industry for many years, and is also the supply source of machine tools that are fuelling the significant expansion now taking place in Eastern Europe. Nikken Deutschland GmbH has its base at the centre of the huge market of Germany and Eastern Europe, and continues to broaden the range of the company's sales operations.

NIKKEN has achieved some impressive successes in Germany with its CNC rotary tables and tool holders thanks to a long sales history of the company's sales activities. A sales force consisting mainly of German personnel stands on the front line of this activity to address the sales and servicing needs of the entire country. More specifically, the company provides technical advice, repairs, aftersales support and other services to end users, distributors and machine dealers.



Nikken Deutschland GmbH has participated in and contributed to many trade shows and exhibitions held in Germany, including the EMO show, METAF, AMB and EURO MOULD. The company's fully furnished showroom is a Mecca of information to the constant stream of visitors who can inspect products and examples of machining, as well as receive application advice and technical training. They can handle NIKKEN's products for themselves, learn about the construction and capability of the CNC rotary tables, and learn about the accuracy and other features of NIKKEN's products.

A complete support organisation is in place to ensure that advice is relayed promptly by telephone and other rapid communication media, that repairs or delivery of tool holders and CNC rotary tables are carried out promptly with all due diligence, and that emergency service calls are responded to rapidly.

To enable speedy delivery of standard items in the German market and of popular products compliant with European standards, Nikken Deutschland GmbH works closely with Nikken Euro Centre to keep a full stock at its disposal. The company uses the most appropriate type of delivery in each case, including parcel post, DHL, door-to-door service and flash shipment, to meet the demands of customers.

The sales territory of Nikken Deutschland GmbH spans the vast area of eastern Europe and covers such countries as the Czech Republic, Slovakia, Austria, Russia, Poland, Hungary, Romania and Bulgaria, all countries in which Japanese companies are rapidly expanding their business. The service is not limited to sales, but engineers make on-site adjustments, repairs and service calls as well.

To make it possible to support all types of motors and controllers for NIKKEN's CNC rotary tables, the company has set up trial run equipment that accommodates many different motors, and offers a full range of accessories including tailstocks, support tables, scroll chucks and collet chucks adapted to the CNC rotary tables. The fact that NIKKEN's CNC rotary tables are endowed with outstanding durability and that a complete support service is provided instils confidence in users that the equipment will give outstanding service in the years ahead.

Procomo France S.A.S was established 30 years ago with the avowed intent to deliver the high-accuracy and high-quality tool holders and CNC rotary tables as well as related services, applications and after-sales servicing, into the hands of engineers in France. A major milestone in the company's history was marked in 2006 with the change of the company name to PROCOMO-NIKKEN, and the company took on a new lease of life as NIKKEN's wholly owned subsidiary in France.



In 2005, PROCOMO-NIKKEN embarked on a complete renovation of its buildings and facilities in order to make it possible for users to gain hands-on experience of NIKKEN's products in a bright and comfortable environment.

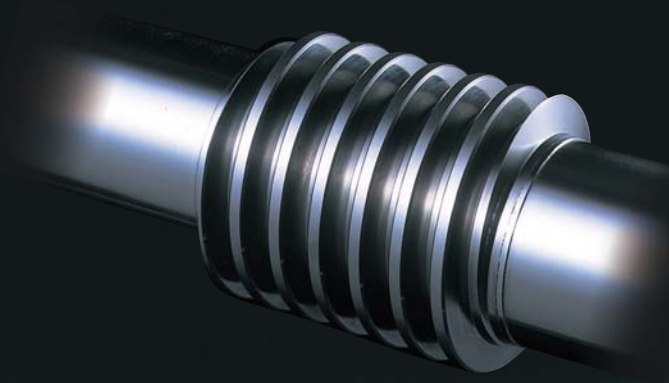


In the meeting room, which is fitted out with all the latest multimedia technology, technical seminars are regularly held so that attendees will come away with a clear understanding of NIKKEN's products and technology. The showroom is where videos of cutting operations are screened, and visitors can actually handle some of NIKKEN's products in this room as well. The machining centre, which is used for cutting trials, enables visitors to identify what makes NIKKEN's products different from those of other companies and to judge how impressive are the machining accuracy and advanced cutting capabilities of NIKKEN's products. As the top tool holder manufacturer, NIKKEN believes is that once customers have their own personal experience of the low machining noise, attractive-looking cut surfaces and uniform discharge of chips, they will be convinced that they can completely trust in and depend on the expertise and capabilities of the company.



The stocks of a large number of standard products are always on hand, enabling the products that customers need to be delivered in the shortest possible time. The NIKKEN Euro Centre and PROCOMO-NIKKEN retain constant and close contact; together they take on the challenge of how to machine products in a more rationalized manner, in a shorter time and to a higher accuracy so that France's engineers can meet every need of the French marketplace.

NIKKEN has already earned an enviable reputation in the global marketplace for the high accuracy and outstanding wear resistance of the company's CNC rotary tables. PROCOMO-NIKKEN has a team of five engineers dedicated full-time to providing users with application support prior to placing orders for tool holders and CNC rotary tables and to carrying out the preparation for shipment, education and training programs, maintenance and repairs, and servicing. This support network delivers a wide range of services, while willingly taking up the challenge of coming to grips with new applications.



# NIKKEN KOSAKUSHO WORKS, LTD. OSAKA, JAPAN.

5-1, 1-chome, Minamishinden, Daito-shi, Osaka-fu, Japan. Telephone:072-869-5820 Telefax:072-869-6220

## U.S.A

CA, CT, IL, NC, TX, WA

**LYNDEX-NIKKEN**  
1468 Armour Boulevard,  
Mundelein, ILLINOIS 60060  
Tel.+1-847-367-4800 Fax.+1-847-367-4815

## MEXICO

(From 2014.09)

**HERRAMIENTAS LYNDEX-NIKKEN S.A.de C.V.**  
Av. Hercules #401-13, Fracc. Poligono 3  
Santa Rosa Jauregui, Queretaro 76220  
Tel.+52-55-8421-8421

## FRANCE

**PROCOMO-NIKKEN S.A.S**  
6, avenue du 1er Mai-Z.A.E.Les Glaises 91127  
Palaiseau Cedex  
Tel.+33-(0)-1-69.19.17.35 Fax.+33-(0)-1-69.30.64.68

## UK

**NIKKEN KOSAKUSHO EUROPE LTD.**  
Precision House, Barbot Hall Industrial Estate,  
Rotherham, South Yorkshire, S61 4RL  
Tel.+44-(0)-1709-366306 Fax.+44-(0)-1709-376683

## F.R.GERMANY

**NIKKEN DEUTSCHLAND GmbH**  
Eisenstraße 9c, 65428 Rüsselsheim  
Tel.+49-(0)-6142-550600 Fax.+49-(0)-6142-5506060

## ITALY

**VEGA INTERNATIONAL TOOLS S.P.A**  
Via Asti N°9 10026-Santena(TORINO)  
Tel.+39-011-9497911 Fax.+39-011-9456380

## SWITZERLAND

**NIKKEN SWITZERLAND AG**  
Sumpfstrasse 32-CH-6300-Zug  
Tel.+41-(0)-41-748-5000 Fax.+41-(0)-41-748-5001

## SCANDINAVIA

SWEDEN

**NIKKEN SCANDINAVIA AB**  
Bultgatan 13b, 44240 Kungälv  
Tel.+46-(0)-303-440-600 Fax.+46-(0)-303-58177

## SPAIN & PORTUGAL

**CUTTING TOOL S.L (TOOLING)**  
PORTUETXE 16, BARRIO IGARRA  
E-20018 DONOSTIA-SAN SEBASTIAN  
Tel.+34-(0)-902-820090 Fax.+34-(0)-902-820099  
**NIKKEN EUROPE DIVISORES ESPANA (CNC ROTARY TABLE)**  
Tel.+34-(0)-669-603433

## TURKEY

**NIKKEN KESICI TAKIMLAR SAN. VE ULUSLARARASI TIC. A. S**  
E5 Uzeri Kucukyali Yanyol Irmak Sok.  
Kucukyali Sanayi Sitesi A Blok No:5 Maltepe 34852 Istanbul  
Tel.+90-(0)-216-518-1010 Fax.+90-(0)-216-366-1414

## KOREA

**KOREA NIKKEN LTD.**  
90B-11L, Namdong Industrial Complex, 170, Namdong-Daero,  
Namdong-Gu, Incheon, Korea 405-819  
Tel.+82-(0)-32-763-4461 Fax.+82-(0)-32-763-4464

## P.R.CHINA

**SHANGHAI ZHONG YAN TRADING CO., LTD.**  
BUILDING 1/F, #54, No.1089 QINZHOU RD. (N),  
SHANGHAI, CHINA  
Tel.+86-(0)-216210-2506 Fax.+86-(0)-216210-2083

## SINGAPORE

**NIKKEN KOSAKUSHO ASIA PTE, LTD.**  
268, WOODLANDS CENTRE ROAD, #03-05  
WOODLANDS POINT, SINGAPORE 738931  
Tel.+65-6362-7980 Fax.+65-6362-7980

## THAILAND

**SIAM NIKKEN Co., LTD.**  
127 Moo5 Gauwungjai-Bangturie Road Tambon Tanokkard  
Ampher Muangnakhonpathom Nakhonpathom 73000 Thailand  
Tel.+66(02)178-0503 Fax.+66(02)178-0504

<http://www.nikken-kosakusho.co.jp>  
e-mail : [export@nikken-kosakusho.co.jp](mailto:export@nikken-kosakusho.co.jp)

■ Please give your order to the following agent.

D.IG.10

● Specifications are subject to change without notice.